

## GaAs PHEMT MMIC POWER AMPLIFIER, 2 - 20 GHz

### Typical Applications

The HMC464LP5E is ideal for:

- Telecom Infrastructure
- Microwave Radio & VSAT
- Military EW, ECM & C<sup>3</sup>I
- Test Instrumentation
- Fiber Optics

### Features

- P1dB Output Power: +26 dBm
- Gain: 14 dB
- Output IP3: +30 dBm
- Supply Voltage: +8V @ 290 mA
- 50 Ohm Matched Input/Output
- 25 mm<sup>2</sup> Leadless SMT Package

### Functional Diagram

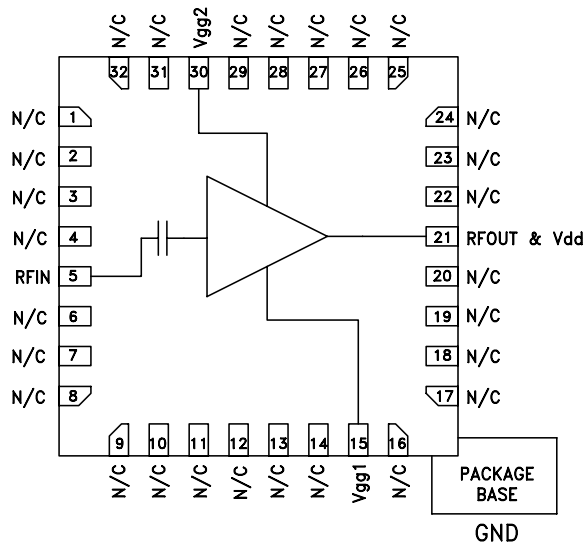

### General Description

The HMC464LP5E is a GaAs MMIC PHEMT Distributed Power Amplifiers in leadless 5 x 5 mm surface mount packages which operate between 2 and 20 GHz. The amplifier provides 14 dB of gain, +30 dBm output IP3 and +26 dBm of output power at 1 dB gain compression while requiring 290 mA from a +8V supply. Gain flatness is good from 2 - 18 GHz making the HMC464LP5E ideal for EW, ECM and radar driver amplifiers as well as test equipment applications. The wideband amplifier I/O's are internally matched to 50 Ohms.

### Electrical Specifications, $T_A = +25^\circ \text{C}$ , $V_{dd} = 8\text{V}$ , $V_{gg2} = 3\text{V}$ , $I_{dd} = 290 \text{mA}$ <sup>[1]</sup>

Parameter	Min.	Typ.	Max.	Min.	Typ.	Max.	Min.	Typ.	Max.	Units
Frequency Range	2.0 - 6.0			6.0 - 16.0			16.0 - 20.0			GHz
Gain	12	14		11.5	13.5		8	11		dB
Gain Flatness		±0.5			±0.5			±1.0		dB
Gain Variation Over Temperature		0.025	0.035		0.03	0.04		0.05	0.06	dB/°C
Input Return Loss		15			10			7		dB
Output Return Loss		15			9			11		dB
Output Power for 1 dB Compression (P1dB)	23.5	26.5		22	25		18	21		dBm
Saturated Output Power (Psat)		27.5			26			24.0		dBm
Output Third Order Intercept (IP3)		32			26			22		dBm
Noise Figure		4.0			4.0			6.0		dB
Supply Current (I <sub>dd</sub> ) (V <sub>dd</sub> = 8V, V <sub>gg</sub> = -0.5V Typ.)		290			290			290		mA

[1] Adjust V<sub>gg1</sub> between -2 to 0V to achieve I<sub>dd</sub> = 290 mA typical.

**GAAS PHEMT MMIC  
POWER AMPLIFIER, 2 - 20 GHz**

**Gain & Return Loss**

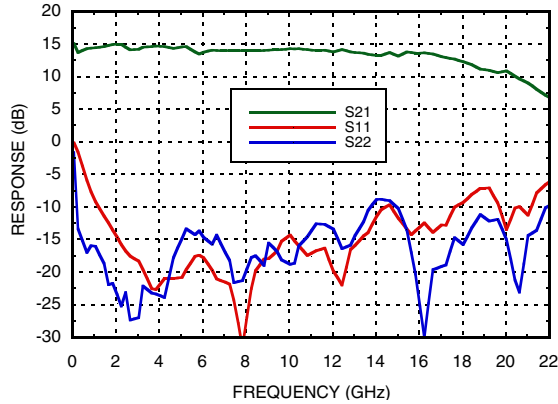

**Gain vs. Temperature**

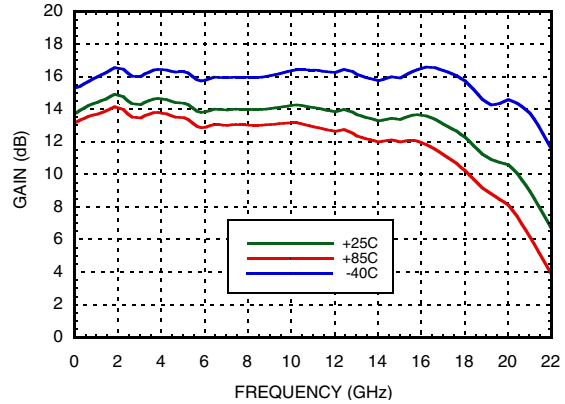

**Input Return Loss vs. Temperature**

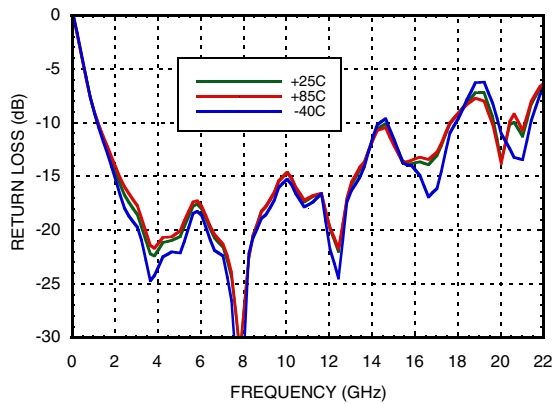

**Output Return Loss vs. Temperature**

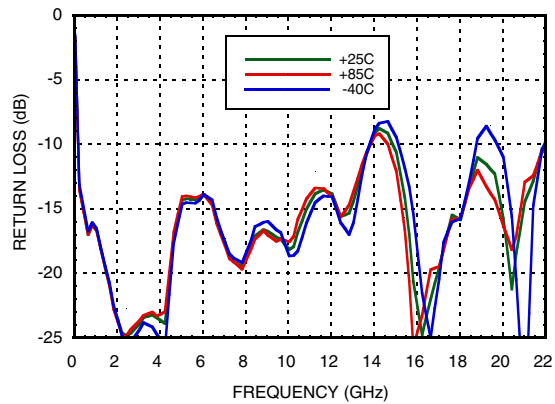

**Gain & Return Loss @ Vdd= 5V, Vgg2= 2V,  
Idd= 160 mA**

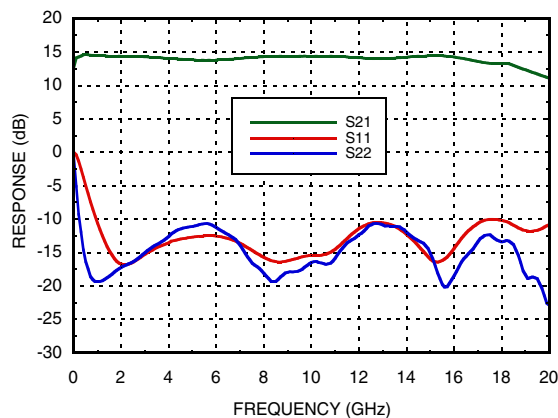

**Gain & Return Loss @ Vdd= 5V, Vgg2= 2V,  
Idd= 180 mA**

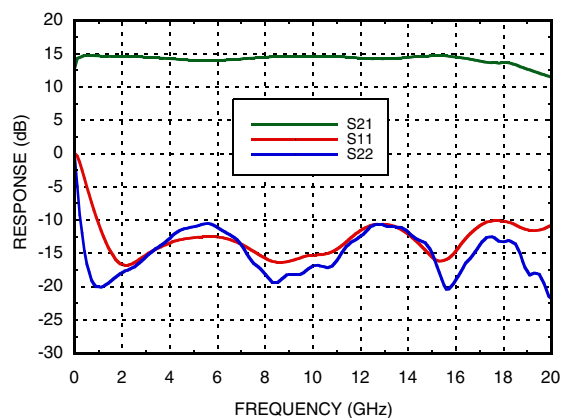

**GAAS PHEMT MMIC  
POWER AMPLIFIER, 2 - 20 GHz**

**Gain & Return Loss @ Vdd= 5V, Vgg2= 2V,  
Idd= 200 mA**

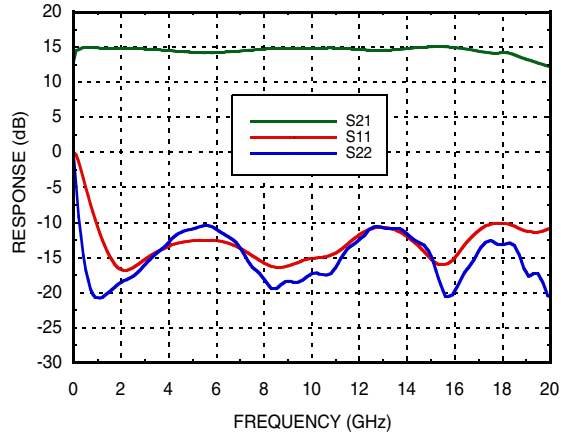

**Reverse Isolation vs. Temperature**

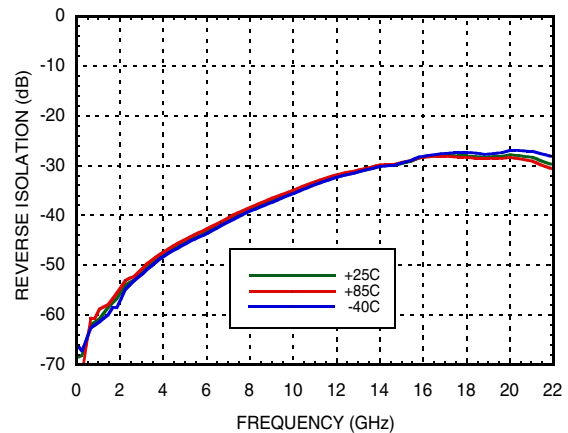

**P1dB vs. Temperature**

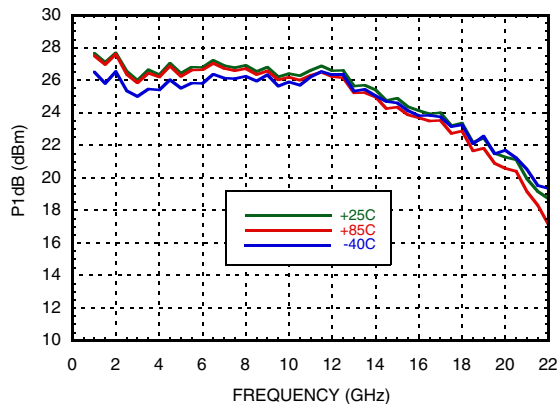

**Noise Figure vs. Temperature**

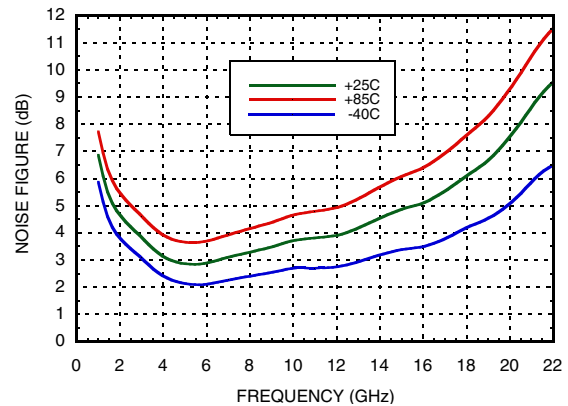

**P1dB vs. Iddq @ Vdd=5V, Vgg2=2V**

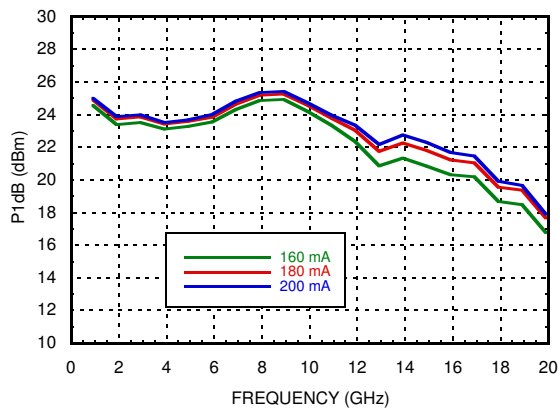

**P1dB vs. Temperature @ Vdd=5V, Vgg2=2V,  
Iddq=160mA**

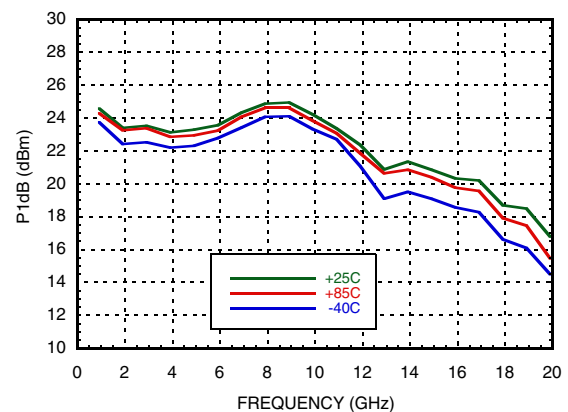

**GAAS PHEMT MMIC  
POWER AMPLIFIER, 2 - 20 GHz**

**P1dB vs. Temperature @ Vdd=5V, Vgg2=2V, Iddq=180mA**

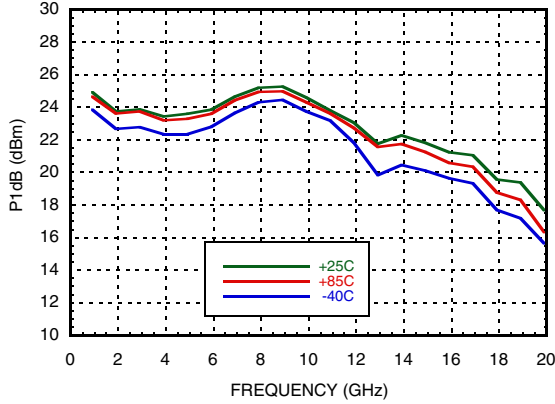

**P1dB vs. Temperature @ Vdd=5V, Vgg2=2V, Iddq=200mA**

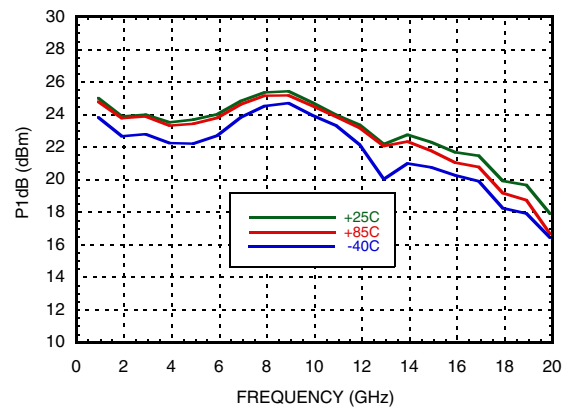

**Power Compression at 10.9 GHz**

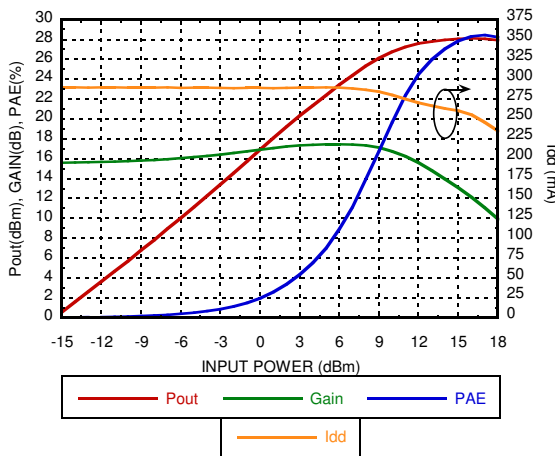

**Psat vs. Temperature**

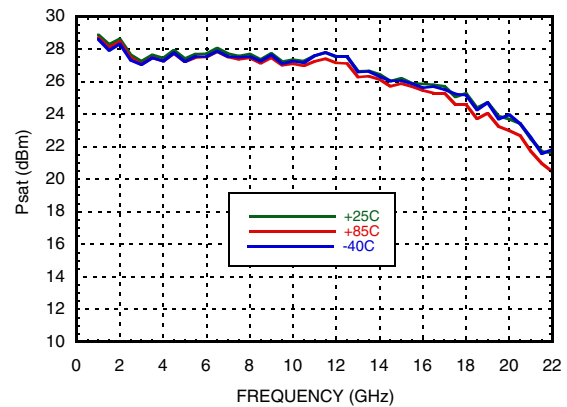

**Psat vs. Iddq @ Vdd=5V, Vgg2=2V**

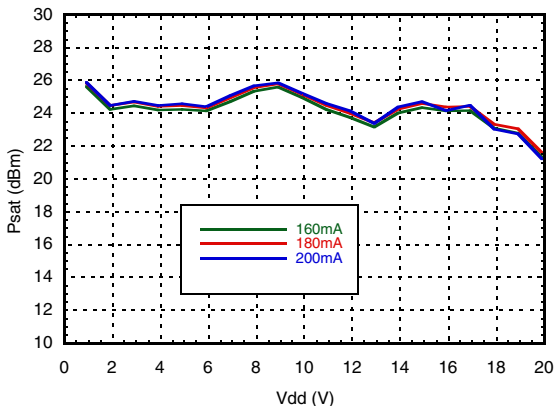

**Psat vs. Temperature @ Vdd=5V, Vgg2=2V, Iddq=160mA**

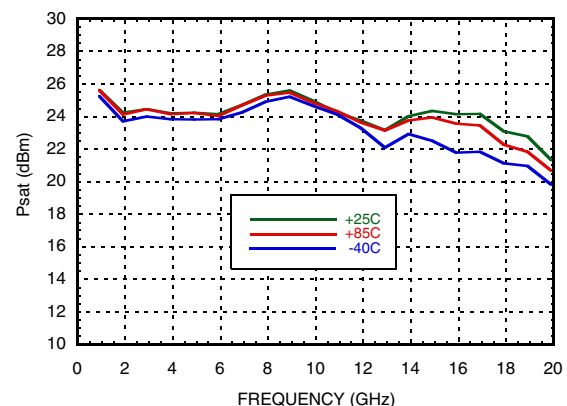

**GAAS PHEMT MMIC  
POWER AMPLIFIER, 2 - 20 GHz**

**Psat vs. Temperature @ Vdd=5V, Vgg2=2V, Iddq=180mA**

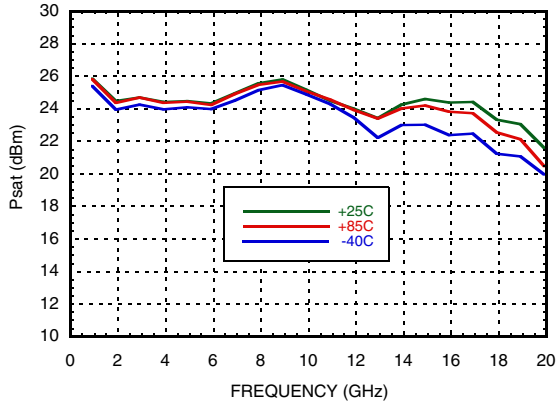

**Psat vs. Temperature @ Vdd=5V, Vgg2=2V, Iddq=200mA**

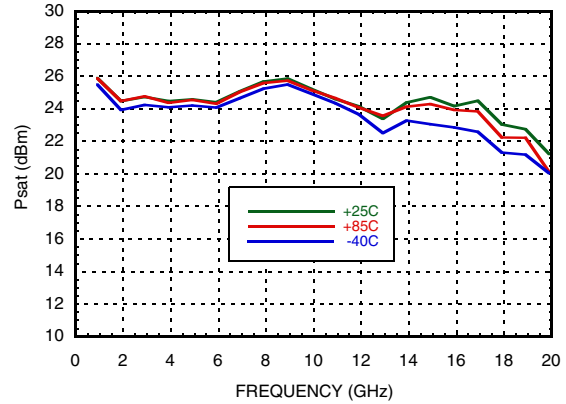

**Output IP3 vs. Temperature**

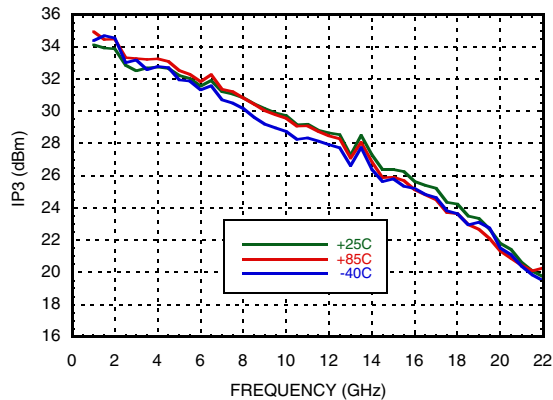

**Output IP3 vs. Iddq @ Vdd=5V, Vgg2=2V**

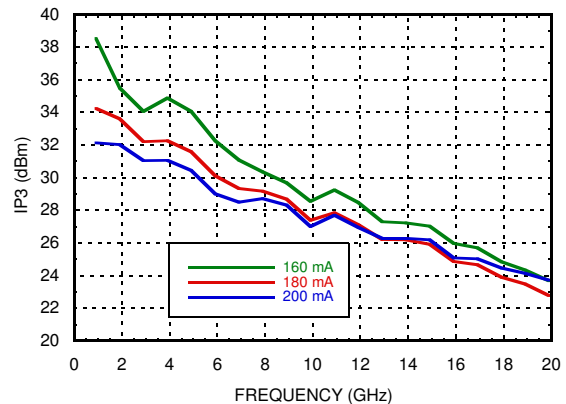

**Output IP3 vs. Temperature @ Vdd=5V, Vgg2=2V, Iddq=160mA**

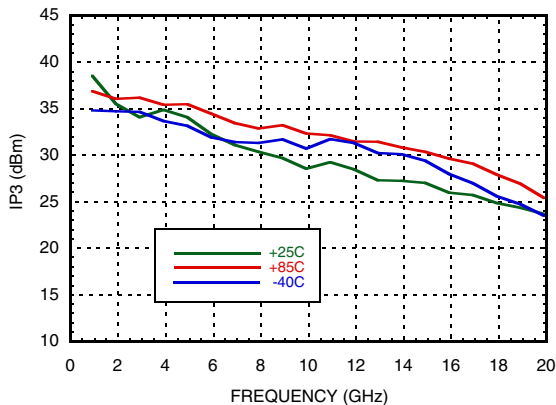

**Output IP3 vs. Temperature @ Vdd=5V, Vgg2=2V, Iddq=180mA**

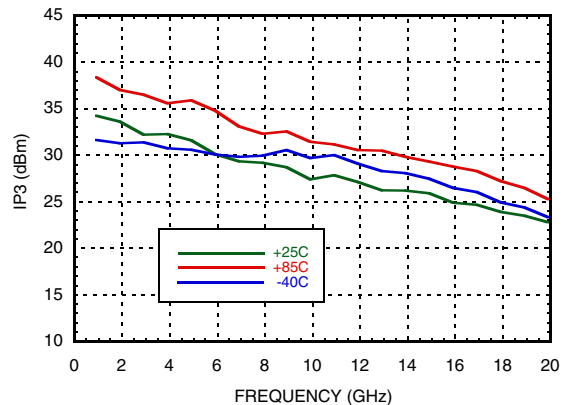

## GAAS PHEMT MMIC POWER AMPLIFIER, 2 - 20 GHz

**Output IP3 vs. Temperature @ Vdd=5V,  
Vgg2=2V, Iddq=200mA**

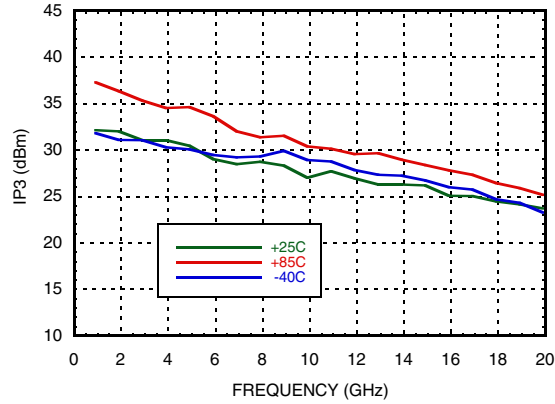

**Gain, Power & Output IP3  
vs. Supply Voltage @ 10 GHz, Fixed Vgg1**

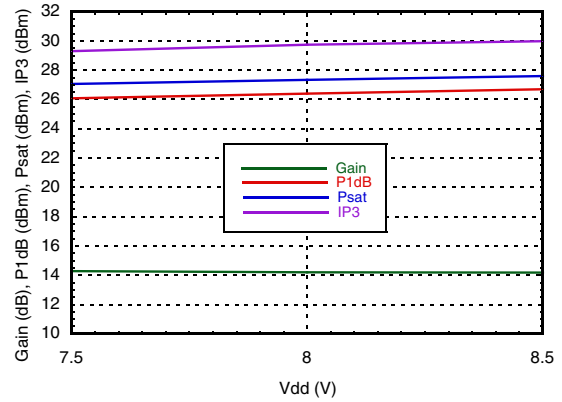

### Absolute Maximum Ratings

Drain Bias Voltage (Vdd)	+9 Vdc
Gate Bias Voltage (Vgg1)	-2 to 0 Vdc
Gate Bias Voltage (Vgg2)	(Vdd - 8.0) Vdc to Vdd
RF Input Power (RFIN)(Vdd = +8 Vdc)	+20 dBm
Channel Temperature	150 °C
Continuous P <sub>diss</sub> (T= 85 °C) (derate 51.5 mW/°C above 85 °C)	3.35 W
Thermal Resistance (channel to ground paddle)	19.4 °C/W
Storage Temperature	-65 to +150 °C
Operating Temperature	-40 to +85 °C
ESD Sensitivity (HBM)	Class 1A

### Typical Supply Current vs. Vdd

Vdd (V)	I <sub>dd</sub> (mA)
+7.5	292
+8.0	290
+8.5	288



ELECTROSTATIC SENSITIVE DEVICE  
OBSERVE HANDLING PRECAUTIONS

**GAAS PHEMT MMIC  
POWER AMPLIFIER, 2 - 20 GHz**

**Outline Drawing**

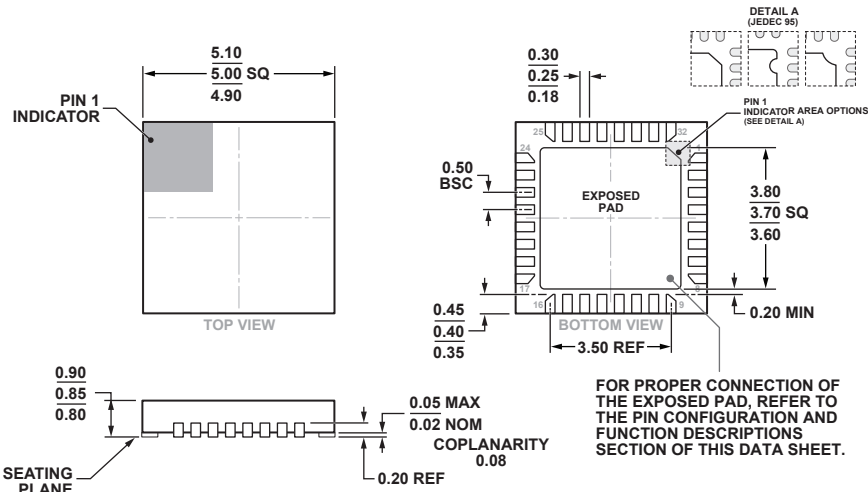

COMPLIANT TO JEDEC STANDARDS MO-220-VHHD-4.

32-Lead Lead Frame Chip Scale Package [LFCSP]  
5 mm × 5 mm Body and 0.85 mm Package Height  
(HCP-32-1)  
Dimensions shown in millimeters.

**Package Information**

Part Number	Package Body Material	Lead Finish	MSL Rating	Package Marking <sup>[2]</sup>
HMC464LP5E	RoHS-compliant Low Stress Injection Molded Plastic	100% matte Sn	MSL1 <sup>[1]</sup>	H464 XXXX

[1] Max peak reflow temperature of 260 °C  
[2] 4-Digit lot number XXXX

## GAAS PHEMT MMIC POWER AMPLIFIER, 2 - 20 GHz

### Pin Descriptions

Pin Number	Function	Description	Interface Schematic
5	RFIN	This pin is AC coupled and matched to 50 Ohms.	RFIN
15	Vgg1	Gate Control for amplifier. Adjust between -2 to 0V to achieve I <sub>dd</sub> = 290 mA.	
21	RFOUT & Vdd	RF output for amplifier. Connect the DC bias (V <sub>dd</sub> ) network to provide drain current (I <sub>dd</sub> ). See application circuit herein.	
30	Vgg2	Control voltage for amplifier. +3V should be applied to Vgg2 for nominal operation.	
Ground Paddle	GND	Ground paddle must be connected to RF/DC ground.	
1 - 4, 6 - 14, 16 - 20, 22 - 29, 31, 32	N/C	No connection. These pins may be connected to RF ground. Performance will not be affected.	

### Application Circuit

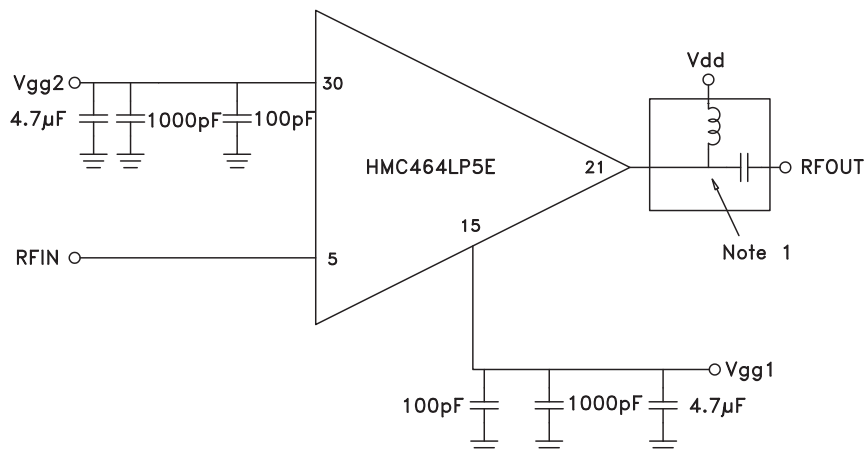

NOTE 1: Drain Bias (V<sub>dd</sub>) must be applied through a broadband bias tee or external bias network.

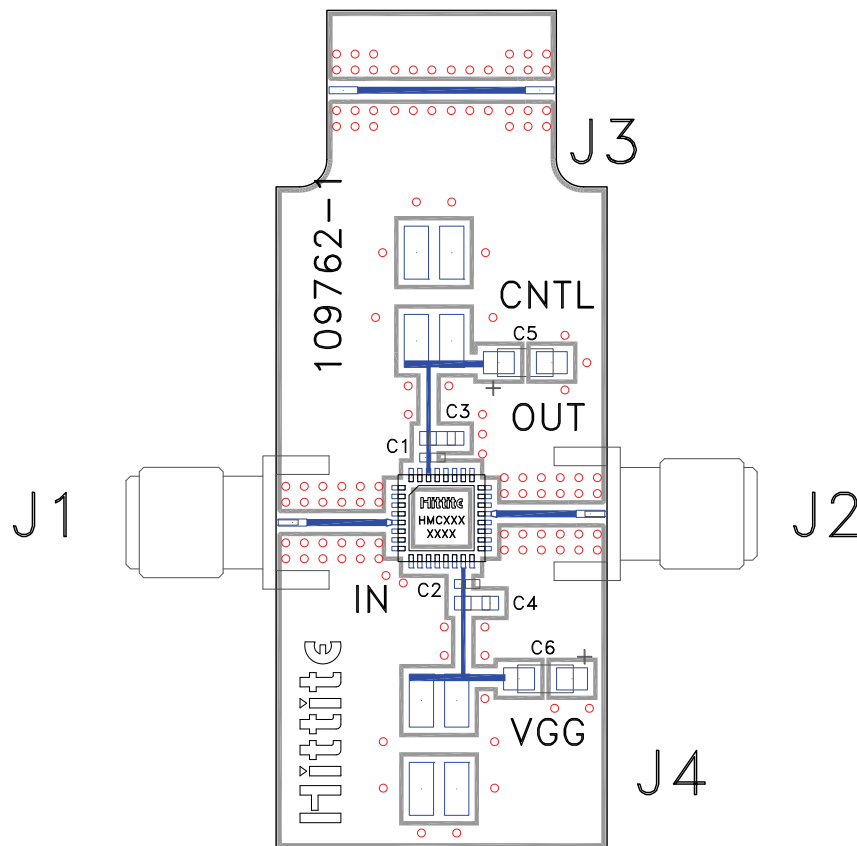

**GAAS PHEMT MMIC  
POWER AMPLIFIER, 2 - 20 GHz**
**Evaluation PCB**

**List of Materials for Evaluation PCB 108344 [1]**

Item	Description
J1, J2	PCB Mount SMA Connector
J3, J4	2 mm Molex Header
C1, C2	100 pF Capacitor, 0402 Pkg.
C3, C4	1000 pF Capacitor, 0603 Pkg.
C5, C6	4.7 μF Capacitor, Tantalum
U1	HMC464LP5E
PCB [2]	109762 Evaluation PCB

[1] Reference this number when ordering complete evaluation PCB

[2] Circuit Board Material: Rogers 4350

The circuit board used in the final application should use RF circuit design techniques. Signal lines should have 50 Ohm impedance while the package ground leads and package bottom should be connected directly to the ground plane similar to that shown. A sufficient number of via holes should be used to connect the top and bottom ground planes. The evaluation board should be mounted to an appropriate heat sink. The evaluation circuit board shown is available from Analog Devices upon request.

# Mouser Electronics

Authorized Distributor

Click to View Pricing, Inventory, Delivery & Lifecycle Information:

[Analog Devices Inc.:](#)

[108344-HMC464LP5](#)