



SMT GaAs HBT MMIC Divide-by-4, 0.05 - 4 GHz

Typical Applications

Prescaler for DC to C Band PLL Applications:

- UNII, Point-to-Point & VSAT Radios
- 802.11a & HiperLAN WLAN
- Fiber Optic
- Wireless infrastructure (W-CDMA, TD-SCDMA, WiMax, GSM, PCS, DCS, DECT)
- Cellular Infrastructure
- Satellites / VSATs
- Test Equipment/Instrumentation

Features

- Ultra Low SSB Phase Noise: -150 dBc/Hz
- Single-Ended I/O's
- Output Power: -2 dBm
- Single DC Supply: +3V @ 53 mA

Functional Diagram

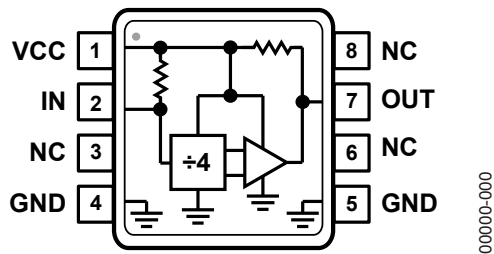

General Description

The ADMV2101 is a low noise Divide-by-4 Static Divider utilizing InGaP GaAs HBT technology in ultra small surface mount MSOP8 plastic package. This device operates from DC (with a square wave input) to 4 GHz input frequency with a single +3V DC supply. Single-ended inputs and outputs reduce component count and cost. The low additive SSB phase noise of -150 dBc/Hz at 100 kHz offset helps the user maintain good system noise performance.

Electrical Specifications, $T_A = +25^\circ\text{C}$, 50 Ohm System, $V_{cc} = +3V_{dc} \pm 5\%$

Parameter	Conditions	Min.	Typ.	Max.	Units
Input Frequency ^{[1], [2]}	Sinewave	0.05		4	GHz
Input Power Range	$F_{in} = 1\text{GHz} - 4\text{GHz}$	-10		10	dBm
Output Power	$F_{in} = 4\text{GHz}$	-5.0	-2.8		
Reverse Leakage	RF Output Terminated, $F_{in} = 2\text{GHz}$, $P_{in} = 0\text{dBm}$		-20		dBm
SSB Phase Noise (100 kHz offset)	$P_{in} = 0\text{dBm}$, $F_{in} = 4\text{GHz}$		-150		dBc/Hz
Output Transition Time	$P_{in} = 0\text{dBm}$, $F_{out} = 882\text{MHz}$		120		ps
Supply Current (I_{cc})	$V_{cc} = +3.0V$		55	71	mA

¹ Divider will operate down to DC levels. Square-wave input required below 200MHz.

² For stable operation without an input signal, refer to Analog Devices Application Note, "Frequency Divider Operation & Compensation with No Input Signal."



SMT GaAs HBT MMIC Divide-by-4, 0.05 - 4 GHz

Input Sensitivity Window, $T = 25\text{ }^\circ\text{C}$

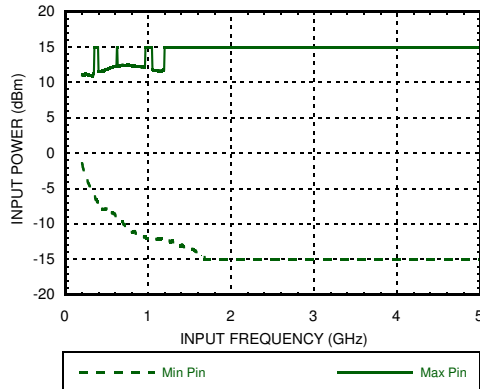

Input Sensitivity Window vs. Temperature

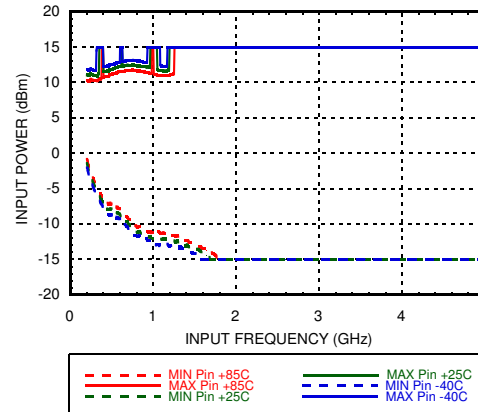

Output Power vs. Temperature, $P_{in} = 0\text{ dBm}$

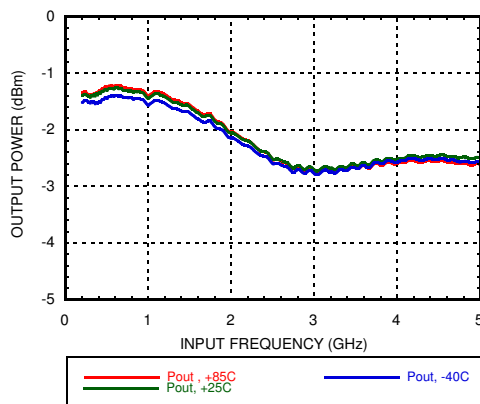

SSB Phase Noise

Performance, $P_{in} = 0\text{ dBm}$, $F_{in} = 4\text{ GHz}$

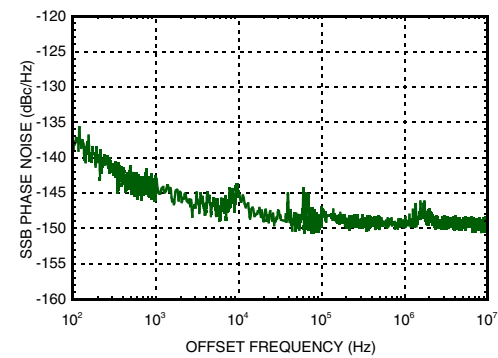

Output Harmonic Content, $P_{in} = 0\text{ dBm}$, $T = 25\text{ }^\circ\text{C}$

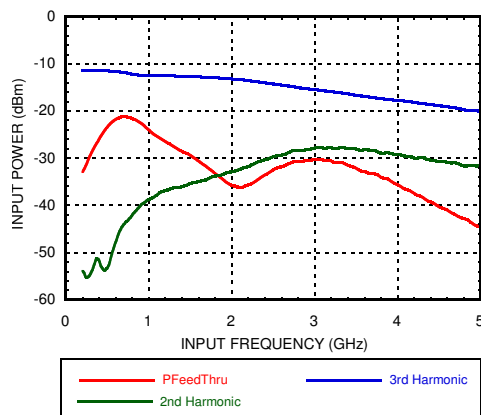

Reverse Leakage, $P_{in} = 0\text{ dBm}$, $T = 25\text{ }^\circ\text{C}$

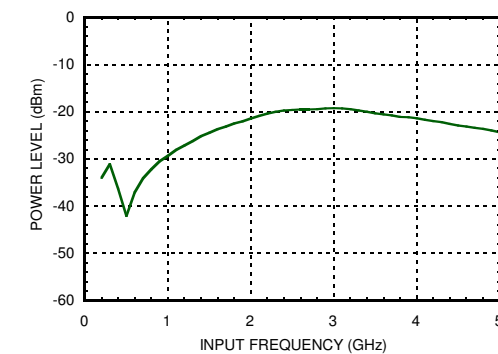



SMT GaAs HBT MMIC
Divide-by-4, 0.05 - 4 GHz

Output Voltage Waveform,
 $P_{in} = 0 \text{ dBm}$, $F_{out} = 882 \text{ MHz}$, $T = 25 \text{ }^\circ\text{C}$

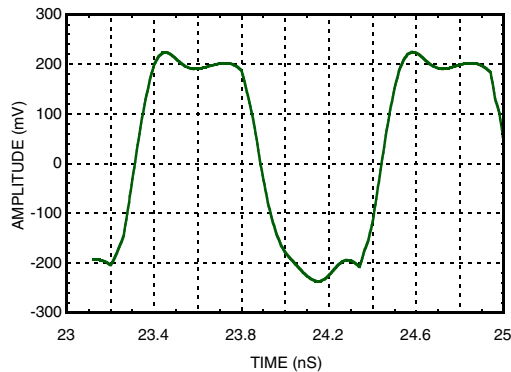

Absolute Maximum Ratings

RF Input Power ($V_{cc} = +3V$)	15 dBm
Nominal +3V Supply to GND	-0.3V to +3.5V
Max Peak Flow Temperature	260 $^\circ\text{C}$
Storage Temperature	-65 to +125 $^\circ\text{C}$
ESD Rating	FICDM - Class IV, HBM - Class 0

Reliability Information

Junction Temperature to Maintain 1 Million Hour MTTF	135 $^\circ\text{C}$
Nominal Junction Temperature ($T = 85 \text{ }^\circ\text{C}$)	99 $^\circ\text{C}$
Thermal Resistance (Junction to GND Paddle, 3V Supply)	83 $^\circ\text{C/W}$
Operating Temperature	-40 to +85 $^\circ\text{C}$

DC blocking capacitors are required at RF input and RF output ports.
Choose value for lowest frequency of operation.



ELECTROSTATIC SENSITIVE DEVICE
OBSERVE HANDLING PRECAUTIONS

Typical Supply Current vs. V_{cc}

V_{cc} (V)	I_{cc} (mA)
2.70	45
3.0	55
3.30	66

Note: Divider will operate over full voltage range shown above

Outline Drawing

8-Lead Mini Small Outline Package with Exposed Pad [MINI_SO_EP]
(RH-8-2)
Dimensions shown in millimeters

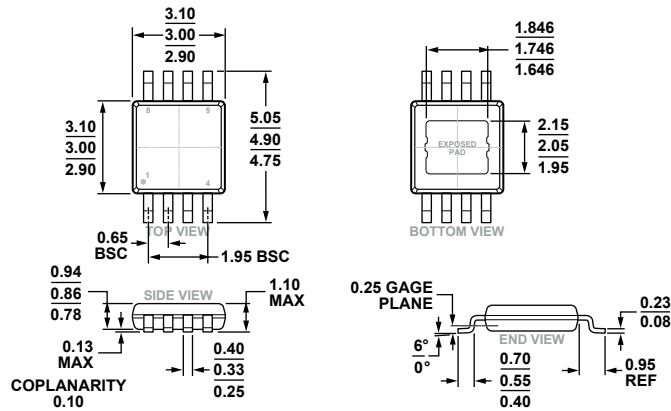

COMPLIANT TO JEDEC STANDARDS MO-187-AA-T

Package Information



Part Number	Package Body Material	Lead Finish	MSL Rating	Package Marking
ADMV2101	RoHS-compliant Low Stress Injection Molded Plastic	100% matte Sn	MSL3 ^[1]	#V 1B

[1] Max peak reflow temperature of 260 °C

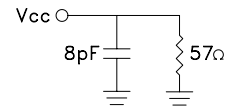
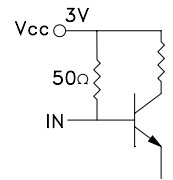

SMT GaAs HBT MMIC
Divide-by-4, 0.05 - 4 GHz

Pin Description

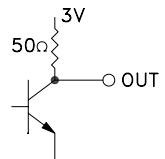
Pin Number	Function	Description	Interface Schematic
1	VCC	Main supply voltage, 3.0Vdc \pm 0.3V	
2	IN	RF input; must use external DC block	
3, 6, 8	NC	No connection or ground. No internal bond.	
4, 5	GND	Ground. Must be connected to RF and DC ground.	
7	OUT	RF output; must use external DC block	
Exposed Paddle	GND	Ground. Must be connected to RF and DC ground.	

Mouser Electronics

Authorized Distributor

Click to View Pricing, Inventory, Delivery & Lifecycle Information:

[Analog Devices Inc.:](#)

[ADMV2101BRHZ](#) [ADMV2101BRHZ-R7](#)