

Single Phase Glass Passivated Silicon Bridge Rectifier

$V_{RRM} = 50\text{ V} - 400\text{ V}$

$I_O = 3\text{ A}$

Features

- Low forward voltage
- High surge overload rating
- Ideal for printed circuit boards
- High temperature soldering: 260°C/ 10 s
- Types from 50 V up to 400 V V_{RRM}
- Not ESD Sensitive

Applications

- Switching power supply
- Home appliances, office devices
- Industrial auto-equipments

BR-3 Package

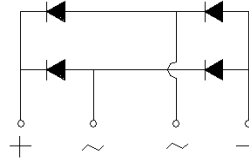

Maximum ratings at $T_A = 25\text{ °C}$, unless otherwise specified

Parameter	Symbol	Conditions	BR305	BR31	BR32	BR34	Unit
Repetitive peak reverse voltage	V_{RRM}		50	100	200	400	V
RMS reverse voltage	V_{RMS}		35	70	140	280	V
DC blocking voltage	V_{DC}		50	100	200	400	V
Operating temperature	T_j		-40 to 125	-40 to 125	-40 to 125	-40 to 125	°C
Storage temperature	T_{stg}		-40 to 150	-40 to 150	-40 to 150	-40 to 150	°C

Electrical characteristics at $T_A = 25\text{ °C}$, unless otherwise specified

Single phase, half sine wave, 50 Hz, resistive load

For capacitive load derate current by 20%

Parameter	Symbol	Conditions	BR305	BR31	BR32	BR34	Unit
Maximum forward rectified current	I_O	$T_A = 40\text{ °C}$	3	3	3	3	A
Peak forward surge current	I_{FSM}	$t_p = 8.3\text{ ms}$	60	60	60	60	A
Maximum forward voltage drop	V_F	$I_F = 1.5\text{ A}$	1.05	1.05	1.05	1.05	V
Maximum reverse current at rated DC blocking voltage	I_R	$T_A = 25\text{ °C}$	10	10	10	10	μA
		$T_A = 125\text{ °C}$	500	500	500	500	
Rating for fusing	I^2t	$1\text{ ms} < t_p < 10\text{ ms},$ $T_j = 25\text{ °C}$	15	15	15	15	A^2s
Thermal resistance	$R_{\theta JA}$		18	18	18	18	°C/W
Mounting Torque	M		2.0 (1.0 N.m is recommended)				N.m

Fig.1: Current Derating Curve

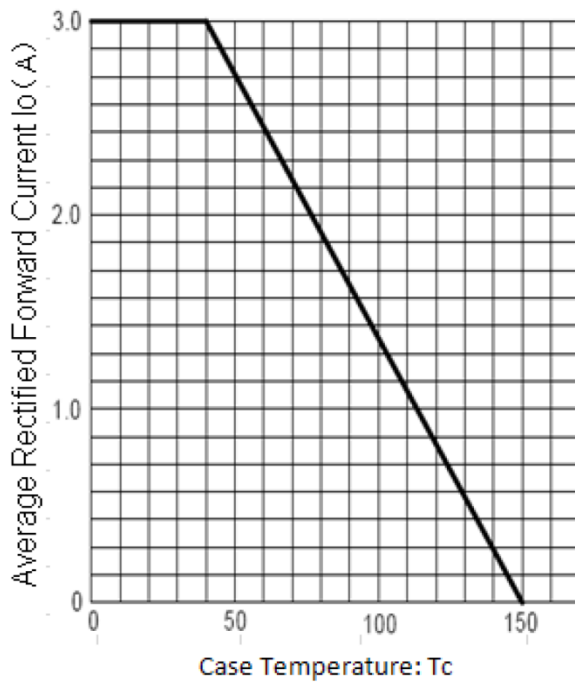

Fig.2: Typical Reverse Characteristics

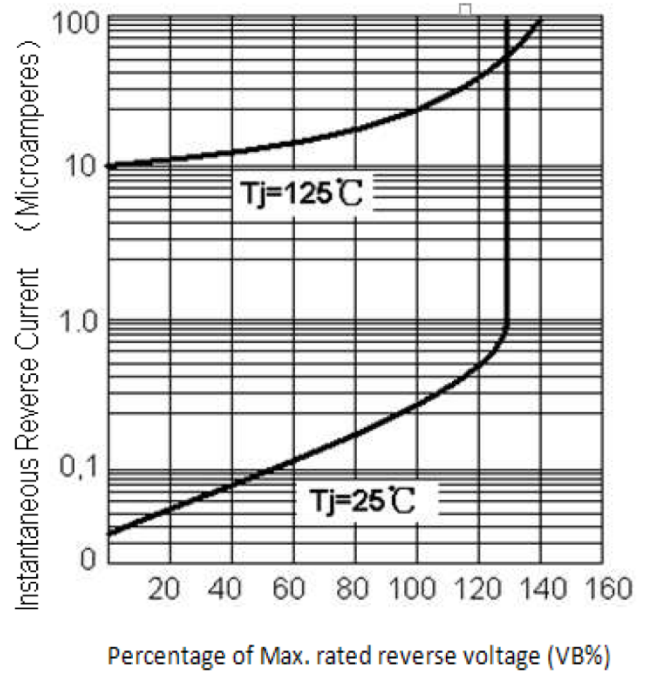

Fig.3: Max. Surge Current

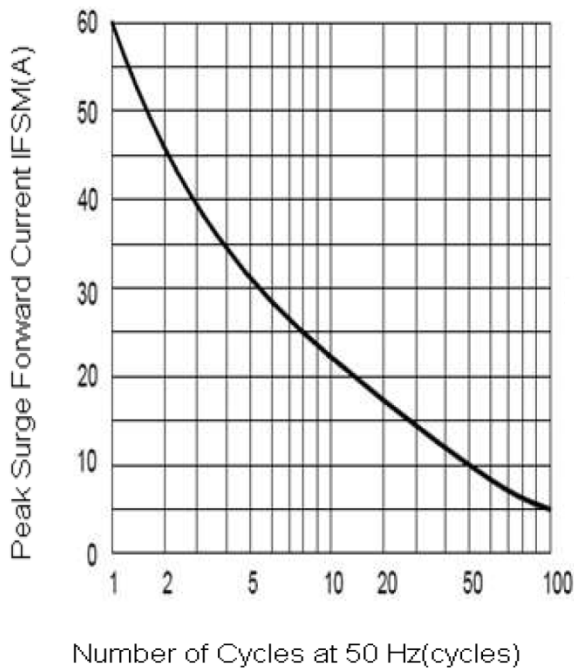
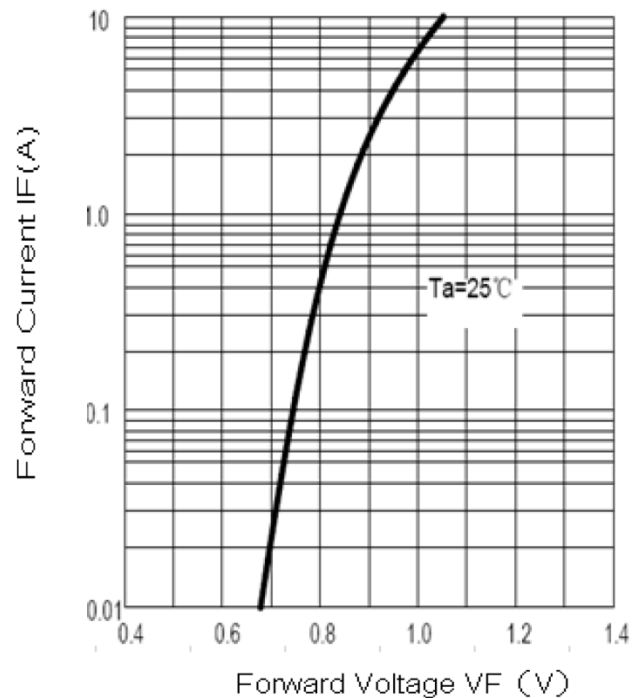

Fig.4: Rated Forward Features



Package dimensions and terminal configuration

Product is marked with part number and terminal configuration.

BR-3

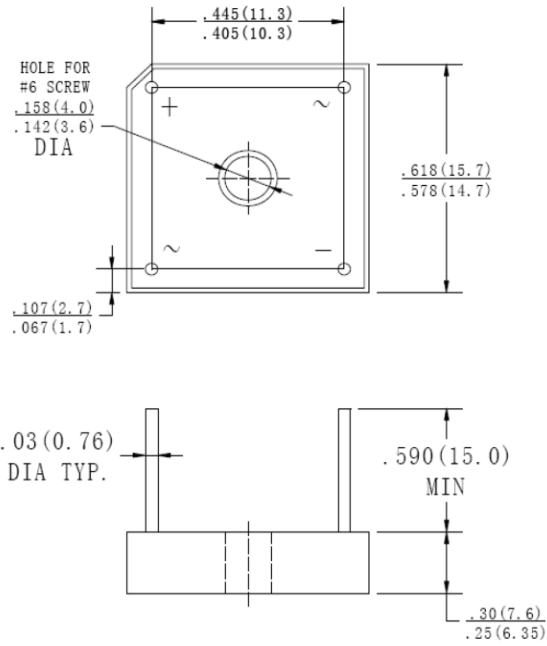

Dimensions in inches and (millimeters)

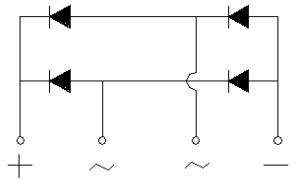

Mouser Electronics

Authorized Distributor

Click to View Pricing, Inventory, Delivery & Lifecycle Information:

[GeneSiC Semiconductor:](#)

[BR305](#)