

**Features**

- $V_{DS} (V) = -40V$
- $I_D = -10.5 A$
- $R_{DS(ON)} < 16m\Omega (V_{GS} = -10V)$
- $R_{DS(ON)} < 27m\Omega (V_{GS} = -4.5V)$
- Ultra Low On-Resistance
- Surface Mount
- Lead-Free

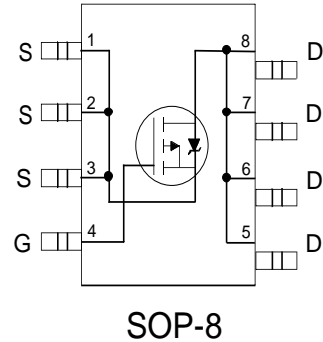

**Description**

The SOP-8 has been modified through a customized leadframe for enhanced thermal characteristics and multiple-die capability making it ideal in a variety of power applications. With these improvements, multiple devices can be used in an application with dramatically reduced board space. The package is designed for vapor phase, infrared, or wave soldering techniques.

**Absolute Maximum Ratings**

	Parameter	Max.	Units
$V_{DS}$	Drain- Source Voltage	-40	V
$I_D @ T_A = 25^\circ C$	Continuous Drain Current, $V_{GS} @ -10V$	-10.5	A
$I_D @ T_A = 70^\circ C$	Continuous Drain Current, $V_{GS} @ -10V$	-8.6	
$I_{DM}$	Pulsed Drain Current ①	-43	
$P_D @ T_A = 25^\circ C$	Power Dissipation ③	2.5	W
$P_D @ T_A = 70^\circ C$	Power Dissipation③	1.6	
	Linear Derating Factor	20	mW/°C
$V_{GS}$	Gate-to-Source Voltage	$\pm 20$	V
$T_J, T_{STG}$	Junction and Storage Temperature Range	-55 to + 150	°C

**Thermal Resistance**

	Parameter	Max.	Units
$R_{\theta JA}$	Maximum Junction-to-Ambient③	50	°C/W

**Electrical Characteristics @ T<sub>J</sub> = 25°C (unless otherwise specified)**

	Parameter	Min.	Typ.	Max.	Units	Conditions
V <sub>(BR)DSS</sub>	Drain-to-Source Breakdown Voltage	-40			V	V <sub>GS</sub> = 0V, I <sub>D</sub> = -250μA
ΔV <sub>(BR)DSS</sub> /ΔT <sub>J</sub>	Breakdown Voltage Temp. Coefficient		-0.025		V/°C	Reference to 25°C, I <sub>D</sub> = -1mA
R <sub>DS(on)</sub>	Static Drain-to-Source On-Resistance			16	mΩ	V <sub>GS</sub> = -10V, I <sub>D</sub> = -10.5A ②
				27		V <sub>GS</sub> = -4.5V, I <sub>D</sub> = -8.4A ②
V <sub>GS(th)</sub>	Gate Threshold Voltage	-1.0		-3.0	V	V <sub>DS</sub> = V <sub>GS</sub> , I <sub>D</sub> = -250μA
g <sub>fs</sub>	Forward Transconductance	17			S	V <sub>DS</sub> = -10V, I <sub>D</sub> = -10.5A
I <sub>DSS</sub>	Drain-to-Source Leakage Current			-15	μA	V <sub>DS</sub> = -32V, V <sub>GS</sub> = 0V
				-25		V <sub>DS</sub> = -32V, V <sub>GS</sub> = 0V, T <sub>J</sub> = 70°C
I <sub>GSS</sub>	Gate-to-Source Forward Leakage			-100	nA	V <sub>GS</sub> = -20V
	Gate-to-Source Reverse Leakage			100		V <sub>GS</sub> = 20V
Q <sub>g</sub>	Total Gate Charge		73	110	nC	I <sub>D</sub> = -10.5A
Q <sub>gs</sub>	Gate-to-Source Charge		31	47		V <sub>DS</sub> = -20V
Q <sub>gd</sub>	Gate-to-Drain ("Miller") Charge		17	26		V <sub>GS</sub> = -10V
t <sub>d(on)</sub>	Turn-On Delay Time		52		ns	V <sub>DD</sub> = -20V ②
t <sub>r</sub>	Rise Time		490			I <sub>D</sub> = -1.0A
t <sub>d(off)</sub>	Turn-Off Delay Time		210			R <sub>G</sub> = 6.0Ω
t <sub>f</sub>	Fall Time		97			V <sub>GS</sub> = -10V
C <sub>iss</sub>	Input Capacitance		9250		pF	V <sub>GS</sub> = 0V
C <sub>oss</sub>	Output Capacitance		580			V <sub>DS</sub> = -25V
C <sub>rss</sub>	Reverse Transfer Capacitance		520			f = 1.0kHz

**Source-Drain Ratings and Characteristics**

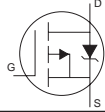
	Parameter	Min.	Typ.	Max.	Units	Conditions
I <sub>S</sub>	Continuous Source Current (Body Diode)			-2.5	A	MOSFET symbol showing the integral reverse p-n junction diode. 
I <sub>SM</sub>	Pulsed Source Current (Body Diode) ①			-43		
V <sub>SD</sub>	Diode Forward Voltage			-1.2	V	T <sub>J</sub> = 25°C, I <sub>S</sub> = -2.5A, V <sub>GS</sub> = 0V ②
t <sub>rr</sub>	Reverse Recovery Time		43	65	ns	T <sub>J</sub> = 25°C, I <sub>F</sub> = -2.5A
Q <sub>rr</sub>	Reverse Recovery Charge		75	110	nC	di/dt = -100A/μs ②

**Notes:**

- ① Repetitive rating; pulse width limited by max. junction temperature.
- ② Pulse width ≤ 400μs; duty cycle ≤ 2%.
- ③ Surface mounted on 1 in square Cu board, t ≤ 5sec.

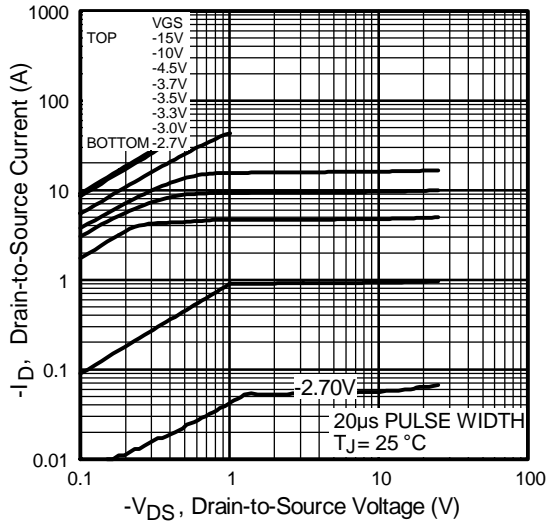

Fig 1. Typical Output Characteristics

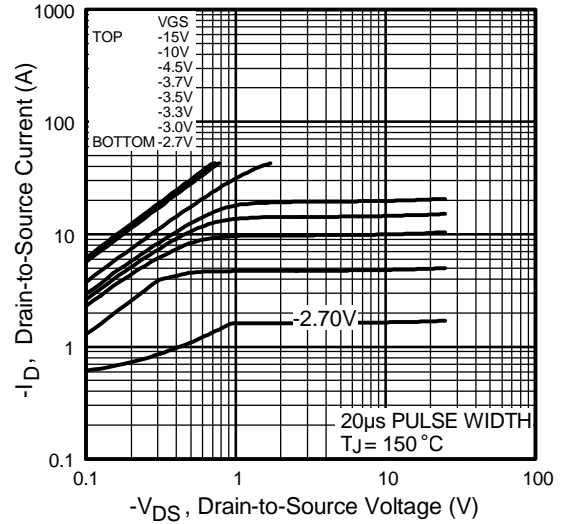

Fig 2. Typical Output Characteristics

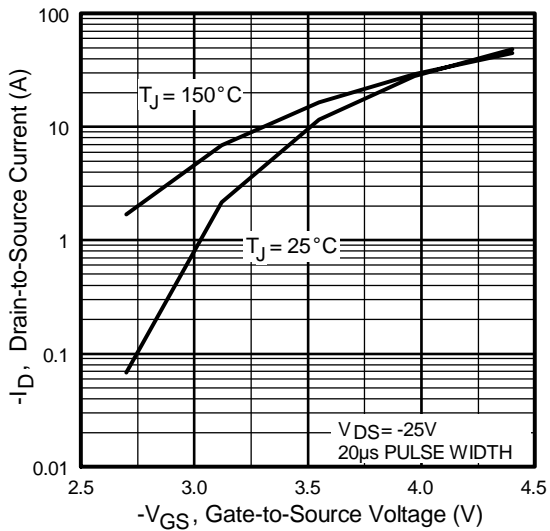

Fig 3. Typical Transfer Characteristics

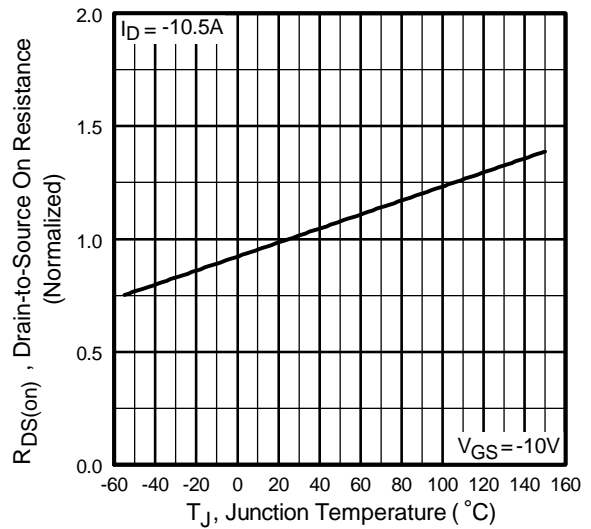

Fig 4. Normalized On-Resistance Vs. Temperature

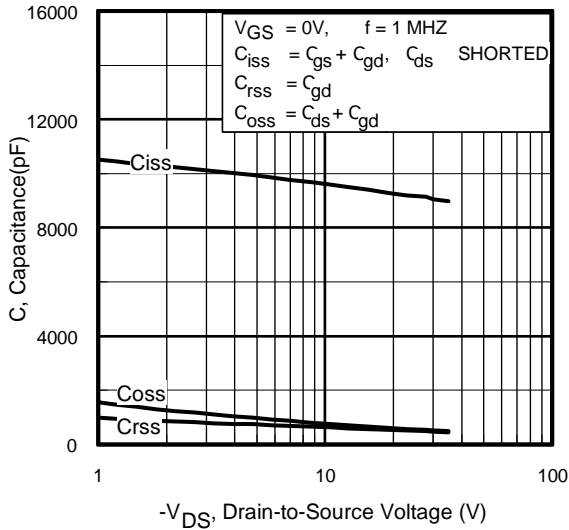

Fig 5. Typical Capacitance Vs. Drain-to-Source Voltage

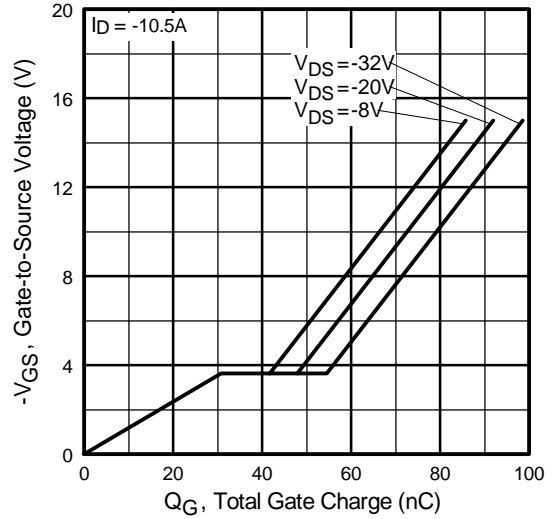

Fig 6. Typical Gate Charge Vs. Gate-to-Source Voltage

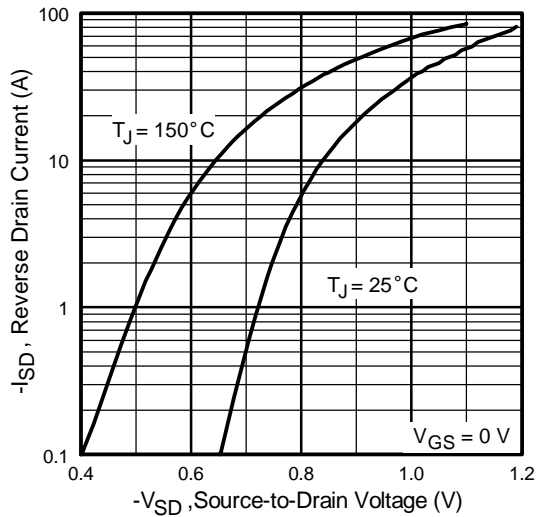

Fig 7. Typical Source-Drain Diode Forward Voltage

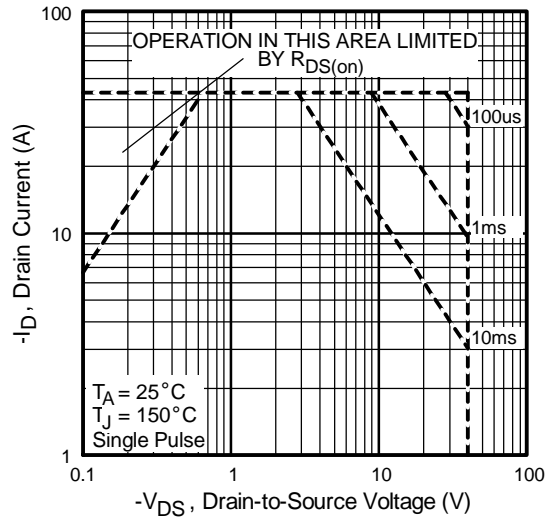

Fig 8. Maximum Safe Operating Area

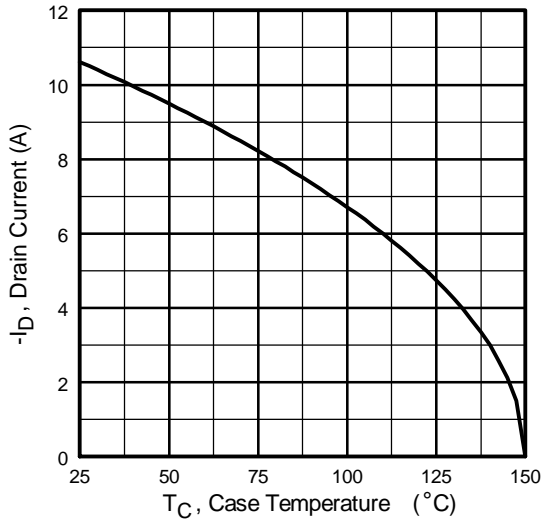

Fig 9. Maximum Drain Current Vs. Case Temperature

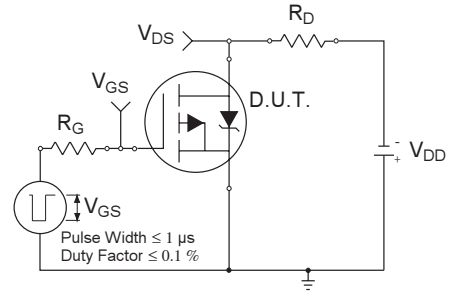

Fig 10a. Switching Time Test Circuit

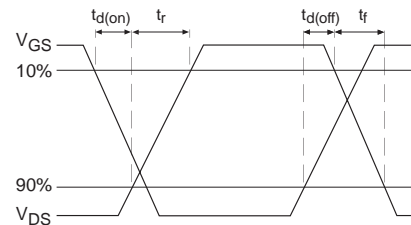

Fig 10b. Switching Time Waveforms

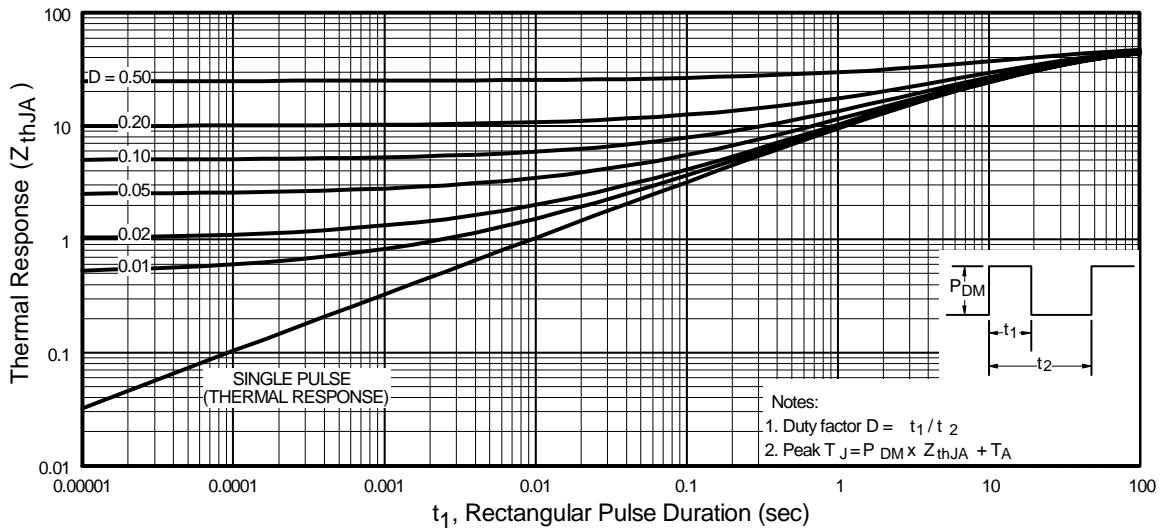

Fig 11. Maximum Effective Transient Thermal Impedance, Junction-to-Ambient

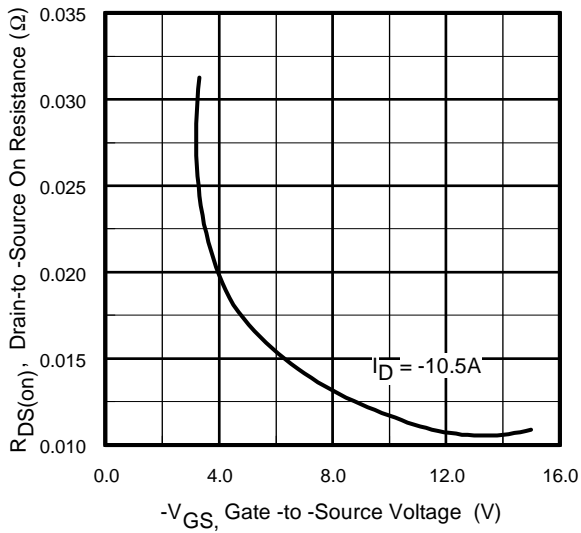

Fig 12. Typical On-Resistance Vs. Gate Voltage

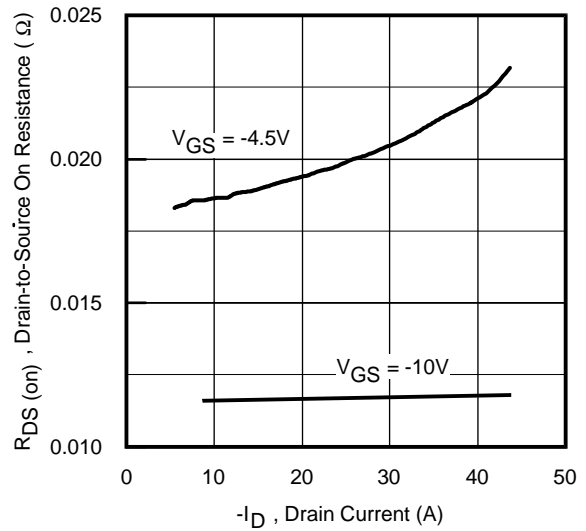

Fig 13. Typical On-Resistance Vs. Drain Current

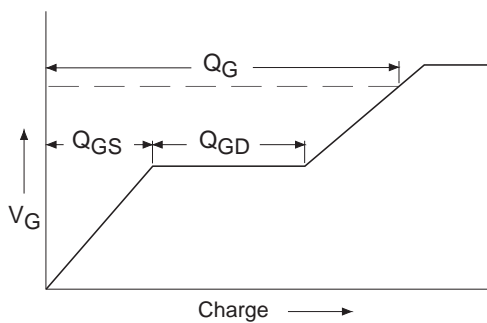

Fig 14a. Basic Gate Charge Waveform

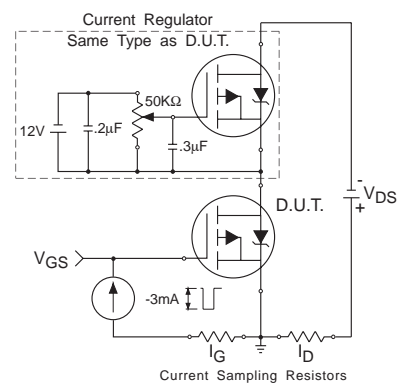
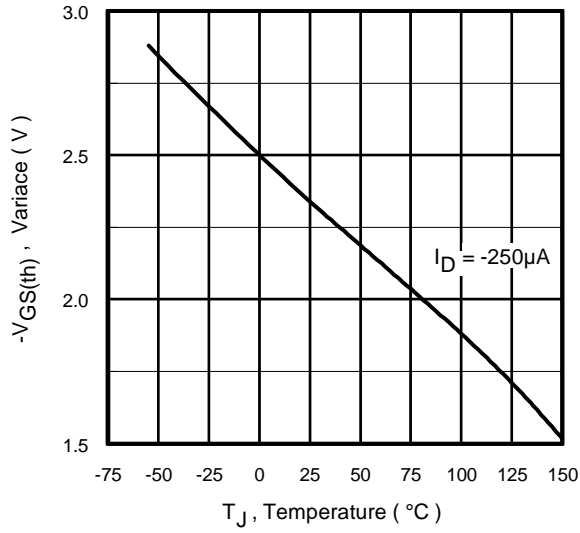
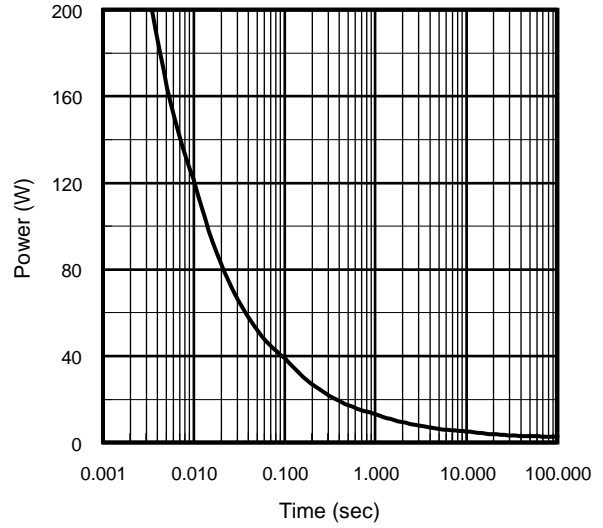

Fig 14b. Gate Charge Test Circuit

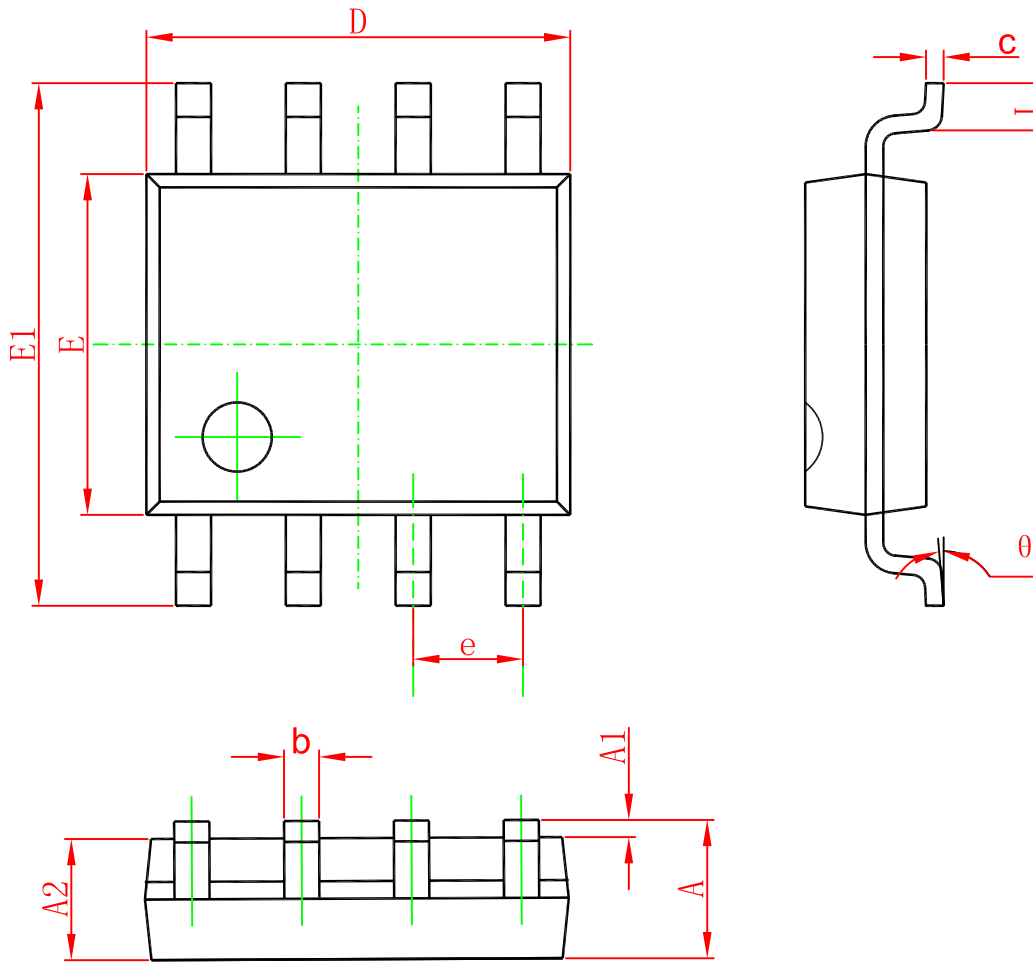

**Fig 15.** Typical Vgs(th) Variance Vs. Junction Temperature



**Fig 16.** Typical Power Vs. Time

SOP-8



Symbol	Dimensions In Millimeters		Dimensions In Inches	
	Min	Max	Min	Max
A	1.350	1.750	0.053	0.069
A1	0.100	0.250	0.004	0.010
A2	1.350	1.550	0.053	0.061
b	0.330	0.510	0.013	0.020
c	0.170	0.250	0.006	0.010
D	4.700	5.100	0.185	0.200
E	3.800	4.000	0.150	0.157
E1	5.800	6.200	0.228	0.244
e	1.270(BSC)		0.050(BSC)	
L	0.400	1.270	0.016	0.050
$\theta$	0°	8°	0°	8°



## Marking

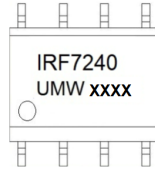

## Ordering information

Order code	Package	Baseqty	Deliverymode
UMW IRF7240TR	SOP-8	3000	Tape and reel