

CZRT5222B-HF Thru. CZRT5256B-HF

Voltage: 2.5 to 30 Volts

Power: 300 mWatts

RoHS Device

Halogen Free

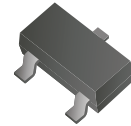

Features

- Planar die construction.
- 300mW power dissipation on FR-4 PCB.
- Ideally suited for automated assembly process.
- General purpose, medium current.

Mechanical data

- Case: SOT-23, Molded plastic.
- Terminals: Solderable per MIL-STD-202G, method 208.
- Polarity: See diagram below.
- Mounting position: Any
- Marking: see table on page2.
- Weight: 0.0078 gram(approx.).

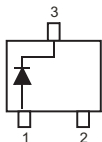
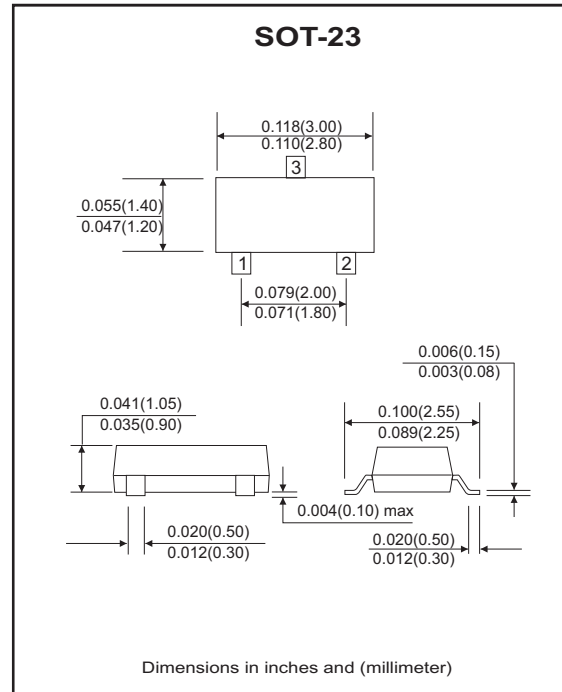

Maximum Ratings (at Ta=25°C unless otherwise noted)

Parameter	Symbol	Value	Unit
Forward voltage @If=10mA	V _F	0.9	V
Power dissipation	P _D	300	mW
Thermal resistance, junction to ambient air	R _{θJA}	417	°C/W
Operating and storage temperature range	T _J , T _{STG}	-65 to +150	°C

Electrical Characteristics (@Ta = 25°C unless otherwise specified)

Part Number	Zener Voltage			Operating Resistance		Rising Operating Resistance		Reverse Current		Marking Code
	VZ(V)@IZT			ZZT(Ohm)		ZZK(Ohm)		IR(uA)		
	Min.	Nom.	Max.	Max.	IZT(mA)	Max.	IZK(mA)	Max.	VR(V)	
CZRT5222B-HF	2.38	2.5	2.63	30	20.0	1250	0.25	100	1.0	KC2
CZRT5223B-HF	2.57	2.7	2.84	30	20.0	1300	0.25	75	1.0	KC3
CZRT5225B-HF	2.85	3.0	3.15	30	20.0	1600	0.25	50	1.0	KC5
CZRT5226B-HF	3.14	3.3	3.47	28	20.0	1600	0.25	25	1.0	KG1
CZRT5227B-HF	3.42	3.6	3.78	24	20.0	1700	0.25	15	1.0	KG2
CZRT5228B-HF	3.71	3.9	4.10	23	20.0	1900	0.25	10	1.0	KG3
CZRT5229B-HF	4.09	4.3	4.52	22	20.0	2000	0.25	5.0	1.0	KG4
CZRT5230B-HF	4.47	4.7	4.94	19	20.0	1900	0.25	5.0	2.0	KG5
CZRT5231B-HF	4.85	5.1	5.36	17	20.0	1600	0.25	5.0	2.0	KE1
CZRT5232B-HF	5.32	5.6	5.88	11	20.0	1600	0.25	5.0	3.0	KE2
CZRT5233B-HF	5.70	6.0	6.30	7	20.0	1600	0.25	5.0	3.5	KE3
CZRT5234B-HF	5.89	6.2	6.51	7	20.0	1000	0.25	5.0	4.0	KE4
CZRT5235B-HF	6.46	6.8	7.14	5	20.0	750	0.25	3.0	5.0	KE5
CZRT5236B-HF	7.13	7.5	7.88	6	20.0	500	0.25	3.0	6.0	KF1
CZRT5237B-HF	7.79	8.2	8.61	8	20.0	500	0.25	3.0	6.5	KF2
CZRT5238B-HF	8.27	8.7	9.14	8	20.0	600	0.25	3.0	6.5	KF3
CZRT5239B-HF	8.65	9.1	9.56	10	20.0	600	0.25	3.0	7.0	KF4
CZRT5240B-HF	9.50	10	10.50	17	20.0	600	0.25	3.0	8.0	KF5
CZRT5241B-HF	10.45	11	11.55	22	20.0	600	0.25	2.0	8.4	KH1
CZRT5242B-HF	11.40	12	12.60	30	20.0	600	0.25	1.0	9.1	KH2
CZRT5243B-HF	12.35	13	13.65	13	9.5	600	0.25	0.5	9.9	KH3
CZRT5244B-HF	13.30	14	14.70	15	9.0	600	0.25	0.1	10	KH4
CZRT5245B-HF	14.25	15	15.75	16	8.5	600	0.25	0.1	11	KH5
CZRT5246B-HF	15.20	16	16.80	17	7.8	600	0.25	0.1	12	KJ1
CZRT5247B-HF	16.15	17	17.85	19	7.4	600	0.25	0.1	13	KJ2
CZRT5248B-HF	17.10	18	18.90	21	7.0	600	0.25	0.1	14	KJ3
CZRT5249B-HF	18.05	19	19.95	23	6.6	600	0.25	0.1	14	KJ2
CZRT5250B-HF	19.00	20	21.00	25	6.2	600	0.25	0.1	15	KJ5
CZRT5251B-HF	20.90	22	23.10	29	5.6	600	0.25	0.1	17	KK1
CZRT5252B-HF	22.80	24	25.20	33	5.2	600	0.25	0.1	18	KK2
CZRT5253B-HF	23.75	25	26.25	35	5.0	600	0.25	0.1	19	KK3
CZRT5254B-HF	25.65	27	28.35	41	5.0	600	0.25	0.1	21	KK4
CZRT5255B-HF	26.60	28	29.40	44	4.5	600	0.25	0.1	21	KK5
CZRT5256B-HF	28.50	30	31.50	49	4.2	600	0.25	0.1	23	KM1

Notes:

1. Short duration test pulse used to minimize self-heating effect.
2. f=1KHz.

RATING AND CHARACTERISTIC CURVES (CZRT5222B-HF Thru CZRT5256B-HF)

Fig.1- Power Derating Curve

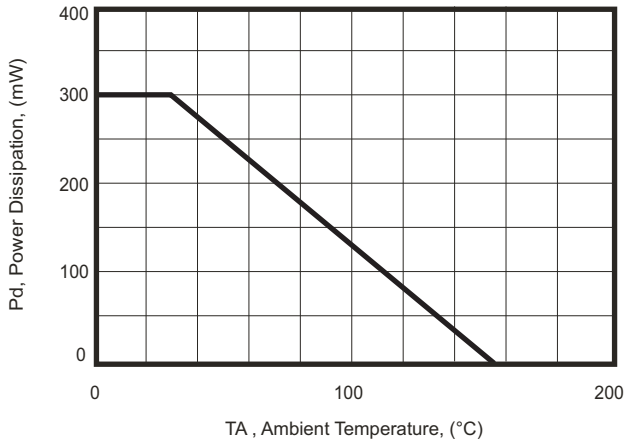

Fig.2- Maximum Non-repetitive Surge Power

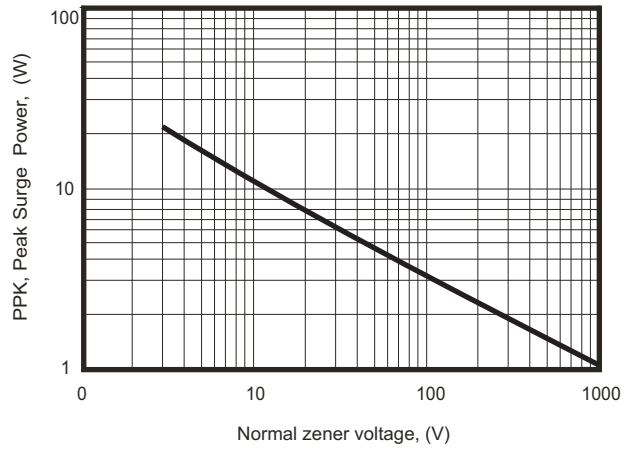

Fig.3- Zener Voltage vs Zener Impedance

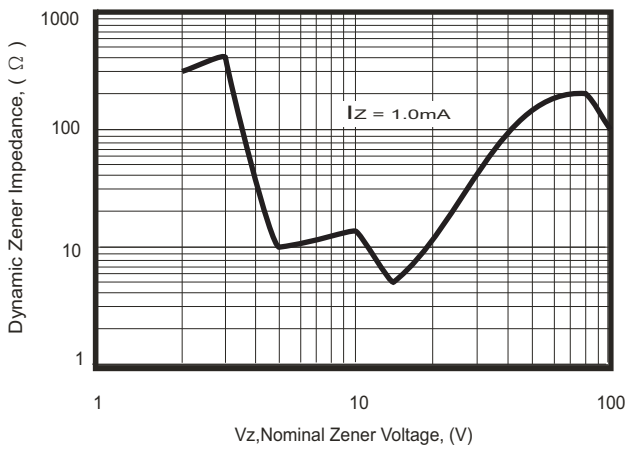

Fig.4- Total Capacitance vs Nominal Zener Voltage

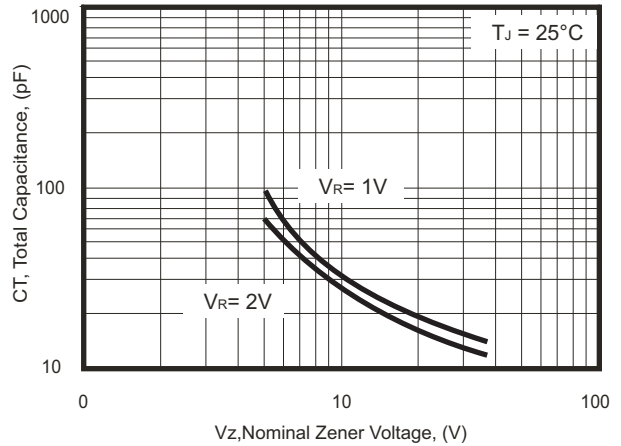

Fig.5- Zener Breakdown Characteristics

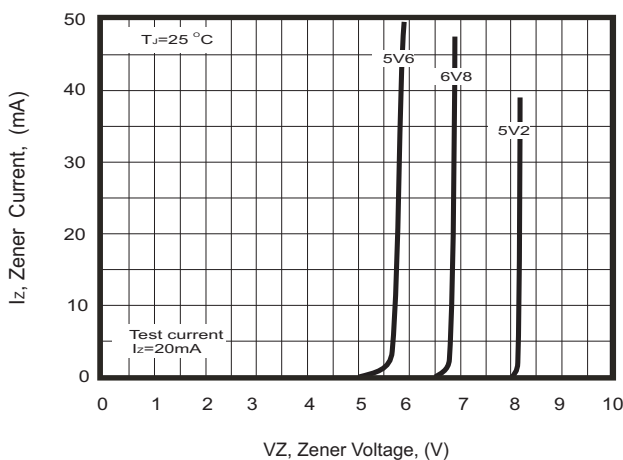
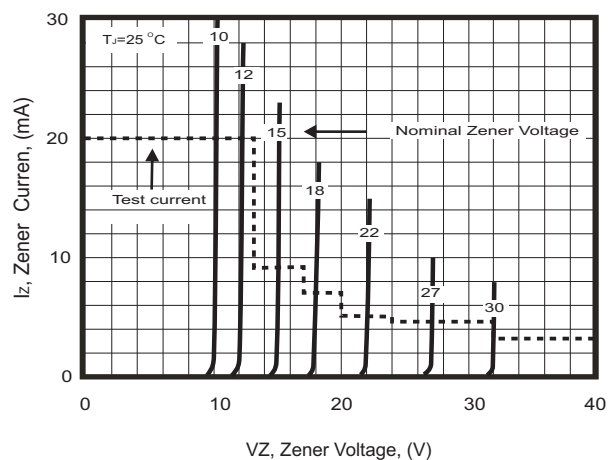
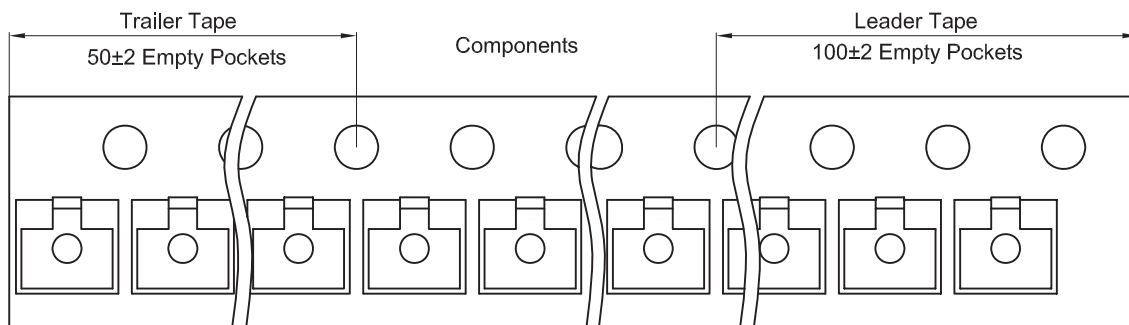
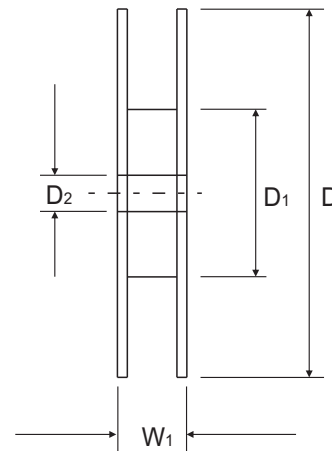
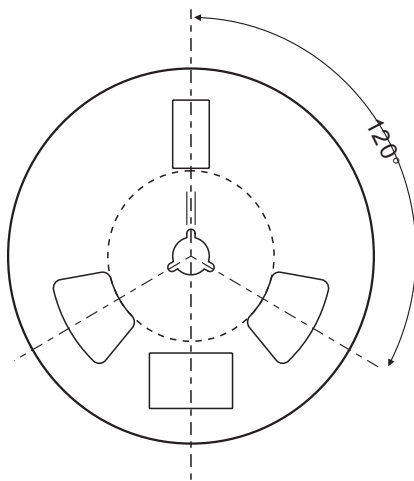
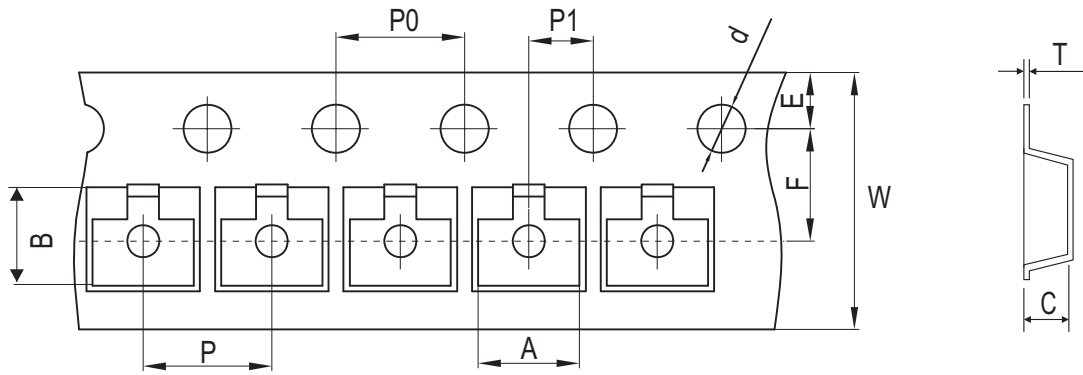

Fig.6- Zener Breakdown Characteristics



Reel Taping Specification



SOT-23	SYMBOL	A	B	C	d	D	D1	D2
	(mm)	3.15 ± 0.10	2.77 ± 0.10	1.22 ± 0.10	Φ1.50 ± 0.10	178 ± 2.00	54.40 ± 1.00	13.00 ± 1.00
	(inch)	0.124 ± 0.004	0.109 ± 0.004	0.048 ± 0.004	Φ0.059 ± 0.004	7.008 ± 0.079	2.142 ± 0.039	0.512 ± 0.039

SOT-23	SYMBOL	E	F	P	P0	P1	W	W1
	(mm)	1.75 ± 0.10	3.50 ± 0.10	4.00 ± 0.10	4.00 ± 0.10	2.00 ± 0.10	8.00 + 0.30 / - 0.10	12.30 ± 1.00
	(inch)	0.069 ± 0.004	0.138 ± 0.004	0.157 ± 0.004	0.157 ± 0.004	0.079 ± 0.004	0.315 + 0.012 / - 0.004	0.484 ± 0.039

Marking Code

Part Number	Marking Code
CZRT5222B-HF ~ CZRT5256B-HF	XXX

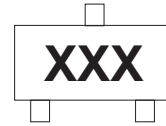

Product type marking code (see page.2)

Suggested PAD Layout

SIZE	SOT-23	
	(mm)	(inch)
A	0.80	0.031
B	1.90	0.075
C	2.02	0.080
D	2.82	0.111

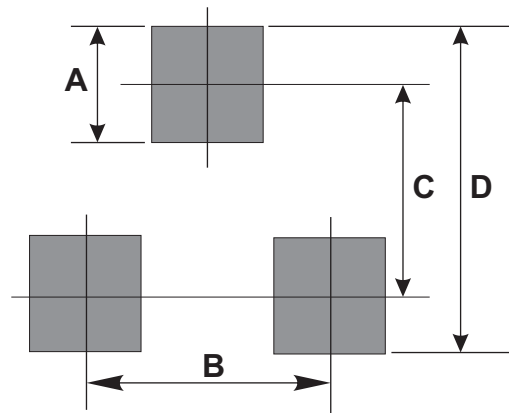

Standard Packaging

Case Type	REEL PACK	
	REEL (pcs)	Reel Size (inch)
SOT-23	3,000	7

Mouser Electronics

Authorized Distributor

Click to View Pricing, Inventory, Delivery & Lifecycle Information:

[Comchip Technology:](#)

[CZRT5228B-HF](#) [CZRT5230B-HF](#) [CZRT5232B-HF](#) [CZRT5231B-HF](#)