



INTEGRATED COMPLEMENTARY BUFFERED-GATE SCRS FOR DUAL POLARITY SLIC OVERVOLTAGE PROTECTION

TISP9110LDM Overvoltage Protector

High Performance Protection for SLICs with +ve and -ve Battery Supplies

- Wide -110 V to +110 V Programming Range
- Low 5 mA max. Gate Triggering Current
- Dynamic Protection Performance Specified for International Surge Waveshapes

Applications include:

- Wireless Local Loop
- Access Equipment
- Regenerated POTS
- VOIP Applications

Rated for International Surge Wave Shapes

Wave Shape	Standard	I _{PPSM} A
2/10	GR-1089-CORE	100
10/700	ITU-T K.20/21/45	45
10/1000	GR-1089-CORE	30

..... UL Recognized Component

Description

The TISP9110LDM is a programmable overvoltage protection device designed to protect modern dual polarity supply rail ringing SLICs (Subscriber Line Interface Circuits) against overvoltages on the telephone line. Overvoltages can be caused by lightning, a.c. power contact and induction. Four separate protection structures are used; two positive and two negative to provide optimum protection during Metallic (Differential) and Longitudinal (Common Mode) protection conditions in both polarities. Dynamic protection performance is specified under typical international surge waveforms from Telcordia GR-1089-CORE, ITU-T K.44 and YD/T 950.

The TISP9110LDM is programmed by connecting the G1 and G2 gate terminals to the negative (-V_{BAT}) and positive (+V_{BAT}) SLIC Battery supplies respectively. This creates a protector operating at typically +1.4 V above +V_{BAT} and -1.4 V below -V_{BAT} under a.c. power induction and power contact conditions. The protector gate circuitry incorporates 4 separate buffer transistors designed to provide independent control for each protection element. The gate buffer transistors minimize supply regulation issues by reducing the gate current drawn to around 5 mA, while the high voltage base emitter structures eliminate the need for expensive reverse bias protection gate diodes.

The TISP9110LDM is rated for common surges contained in regulatory requirements such as ITU-T K.20, K.45, Telcordia GR-1089-CORE, YD/T 950. By the use of appropriate overcurrent protection devices such as the Bourns® Multifuse® and Telefuse™ devices, circuits can be designed to comply with modern telecom standards.

How To Order

Device	Package	Carrier	Order As	Marking Code	Standard Quantity
TISP9110LDM	8-SOIC (210 mil)	Embossed Tape Reeled	TISP9110LDMR-S	9110L	2000

Agency Recognition

Description	
UL	File Number: E215609

8-SOIC (210 mil) Package (Top View)

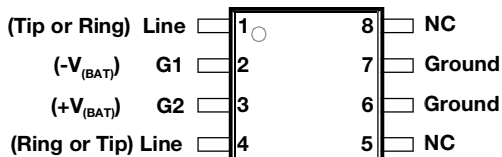

NC - No internal connection
Terminal typical application names shown in parenthesis

MD-8SOIC(210)-003-a

Device Symbol

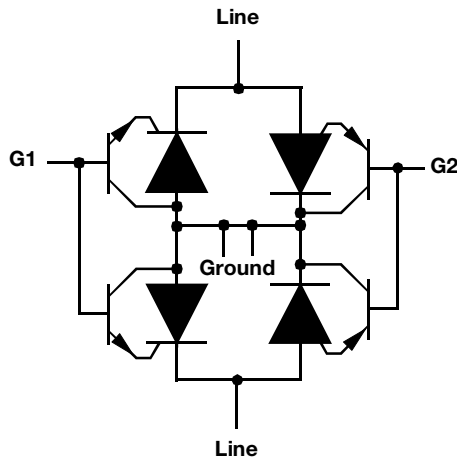

SD-TISP9-001-a



AUGUST 2004 – REVISED JULY 2019
*RoHS Directive 2015/863, Mar 31, 2015 and Annex. Specifications are subject to change without notice. Users should verify actual device performance in their specific applications. The products described herein and this document are subject to specific legal disclaimers as set forth on the last page of this document, and at www.bourns.com/docs/legal/disclaimer.pdf.

TISP9110LDM Overtoltage Protector

BOURNS®

Absolute Maximum Ratings, $T_A = 25\text{ }^\circ\text{C}$ (Unless Otherwise Noted)

Rating	Symbol	Value	Unit
Repetitive peak off-state voltage $V_{G1(\text{Line})} = 0, V_{G2} \geq +5\text{ V}$ $V_{G2(\text{Line})} = 0, V_{G1} \geq -5\text{ V}$	V_{DRM}	-120 +120	V
Non-repetitive peak impulse current (see Notes 1, 2, 3 and 4) 2/10 μs (Telcordia GR-1089-CORE) 5/310 μs (ITU-T K.20, K.21 & K.45, K.44 open-circuit voltage wave shape 10/700 μs) 10/1000 μs (Telcordia GR-1089-CORE)	I_{PPSM}	± 100 ± 45 ± 30	A
Non-repetitive peak on-state current, 50 Hz / 60 Hz (see Notes 1, 2, 3 and 5) 0.2 s 1 s 900 s	I_{TSM}	9.0 5.0 1.7	A
Maximum negative battery supply voltage	V_{G1M}	-110	V
Maximum positive battery supply voltage	V_{G2M}	+110	V
Maximum differential battery supply voltage	$\Delta V_{(\text{BAT})M}$	220	V
Junction temperature	T_J	-40 to +150	$^\circ\text{C}$
Storage temperature range	T_{stg}	-65 to +150	$^\circ\text{C}$

- NOTES: 1. Initially the device must be in thermal equilibrium with $T_J = 25\text{ }^\circ\text{C}$. The surge may be repeated after the device returns to its initial conditions.
2. The rated current values may be applied to either of the Line to Ground terminal pairs. Additionally, both terminal pairs may have their rated current values applied simultaneously (in this case the Ground terminal current will be twice the rated current value of a single terminal pair).
3. Rated currents only apply if pins 6 & 7 (Ground) are connected together.
4. Applies for the following bias conditions: $V_{G1} = -20\text{ V}$ to -110 V , $V_{G2} = 0\text{ V}$ to $+110\text{ V}$.
5. EIA/JESD51-2 environment and EIA/JESD51-7 high effective thermal conductivity test board (multi-layer) connected with 0.6 mm printed wiring track widths.

Electrical Characteristics for any Section, $T_A = 25\text{ }^\circ\text{C}$ (Unless Otherwise Noted)

Parameter	Test Conditions	Min	Typ	Max	Unit
I_D Off-state current	$V_D = V_{\text{DRM}}, V_{G1(\text{Line})} = 0, V_{G2} \geq +5\text{ V}$ $V_D = V_{\text{DRM}}, V_{G2(\text{Line})} = 0, V_{G1} \geq -5\text{ V}$			-5 -50 +5 +50	μA
$I_{G1(\text{Line})}$ Negative-gate leakage current	$V_{G1(\text{Line})} = -220\text{ V}$			-5	μA
$I_{G2(\text{Line})}$ Positive-gate leakage current	$V_{G2(\text{Line})} = +220\text{ V}$			+5	μA
$V_{G1L(\text{BO})}$ Gate - Line impulse breakover voltage	$V_{G1} = -100\text{ V}, I_T = -100\text{ A}$ (see Note 6) $V_{G1} = -100\text{ V}, I_T = -30\text{ A}$			-15 -11	V
$V_{G2L(\text{BO})}$ Gate - Line impulse breakover voltage	$V_{G2} = +100\text{ V}, I_T = +100\text{ A}$ (see Note 6) $V_{G2} = +100\text{ V}, I_T = +30\text{ A}$			+15 +11	V
I_{H^-} Negative holding current	$V_{G1} = -60\text{ V}, I_T = -1\text{ A}, di/dt = 1\text{ A/ms}$	-150			mA
I_{G1T} Negative-gate trigger current	$I_T = -5\text{ A}, t_{p(g)} \geq 20\text{ }\mu\text{s}, V_{G1} = -60\text{ V}$			+5	mA
I_{G2T} Positive-gate trigger current	$I_T = 5\text{ A}, t_{p(g)} \geq 20\text{ }\mu\text{s}, V_{G2} = 60\text{ V}$			-5	mA
C_O Line - Ground off-state capacitance	$f = 1\text{ MHz}, V_D = -3\text{ V}, G1 \text{ \& } G2 \text{ open circuit}$		32		pF

NOTE: 6. Voltage measurements should be made with an oscilloscope with limited bandwidth (20 MHz) to avoid high frequency noise.

AUGUST 2004 – REVISED JULY 2019

Specifications are subject to change without notice.

Users should verify actual device performance in their specific applications.

The products described herein and this document are subject to specific legal disclaimers as set forth on the last page of this document, and at www.bourns.com/docs/legal/disclaimer.pdf.

TISP9110LDM Overvoltage Protector

BOURNS®

Thermal Characteristics, $T_A = 25\text{ }^\circ\text{C}$ (Unless Otherwise Noted)

Parameter	Test Conditions	Min	Typ	Max	Unit
$R_{\theta JA}$ Junction to ambient thermal resistance	EIA/JESD51-7 PCB, EIA/JESD51-2 Environment, $P_{TOT} = 4\text{ W}$ (See Note 7)		55		$^\circ\text{C/W}$

NOTE 7. EIA/JESD51-7 high effective thermal conductivity test board (multi-layer) connected with 0.6 mm printed wiring track widths.

Parameter Measurement Information

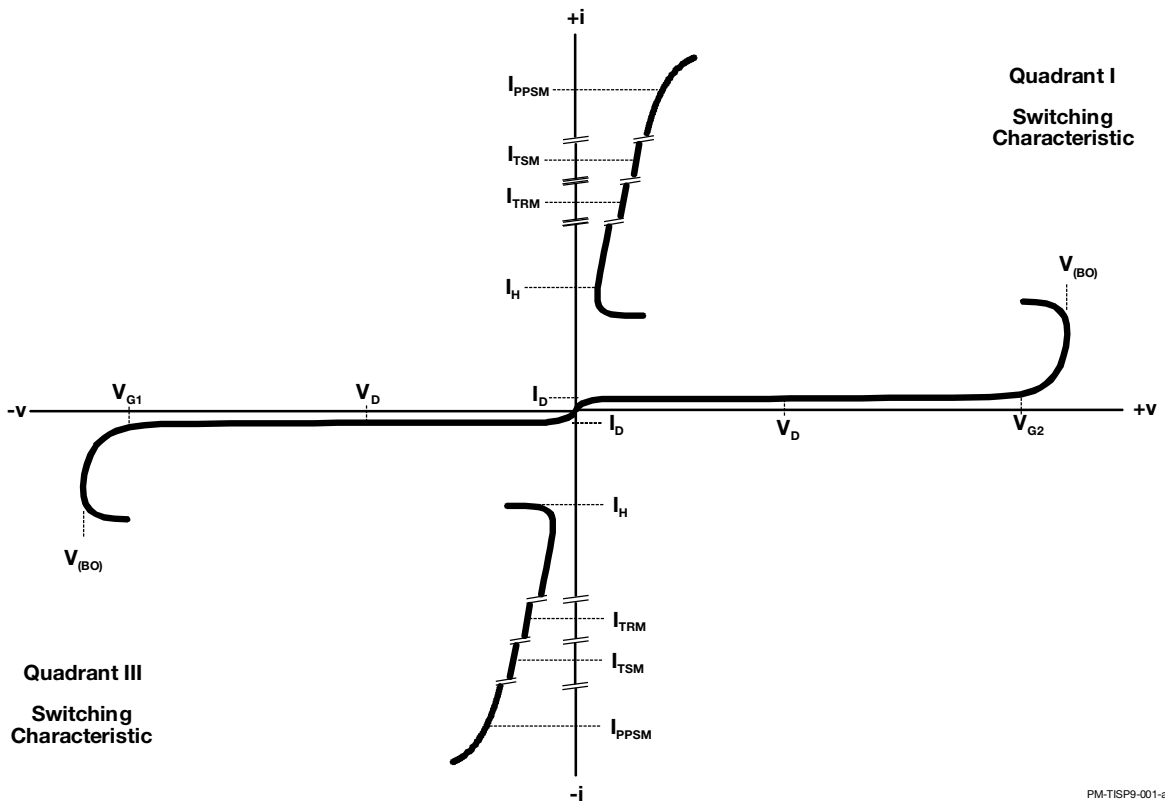

Figure 1. Voltage-Current Characteristic
Unless Otherwise Noted, All Voltages are Referenced to the Ground Terminal

PM-TISP9-001-a

AUGUST 2004 – REVISED JULY 2019

Specifications are subject to change without notice.

Users should verify actual device performance in their specific applications.

The products described herein and this document are subject to specific legal disclaimers as set forth on the last page of this document, and at www.bourns.com/docs/legal/disclaimer.pdf.

Typical Characteristics

OFF-STATE CAPACITANCE vs OFF-STATE VOLTAGE

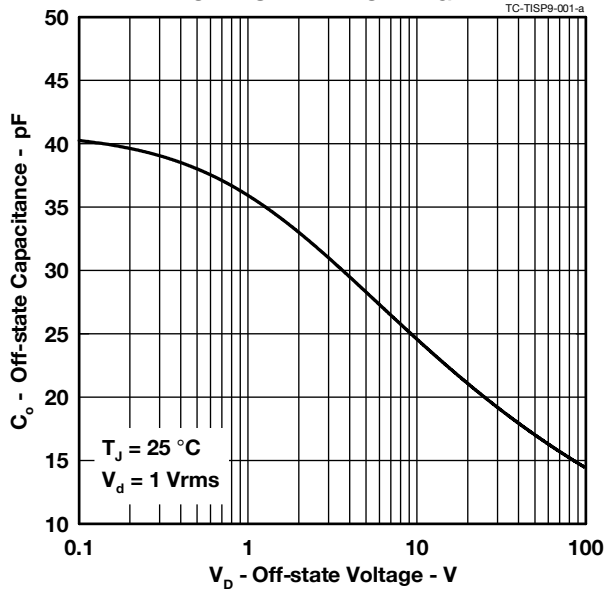

Figure 2.

Thermal Information

NON-REPETITIVE PEAK ON-STATE CURRENT vs CURRENT DURATION

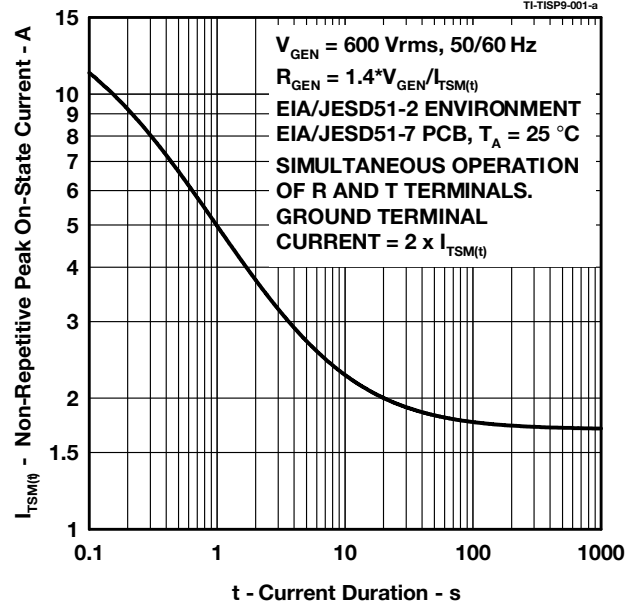

Figure 3.

Asia-Pacific: Tel: +886-2 2562-4117 • Email: asiacus@bourns.com
Europe: Tel: +36 88 885 877 • Email: eurocus@bourns.com
The Americas: Tel: +1-951 781-5500 • Email: americus@bourns.com
www.bourns.com

AUGUST 2004 – REVISED JULY 2019

Specifications are subject to change without notice.

Users should verify actual device performance in their specific applications.

The products described herein and this document are subject to specific legal disclaimers as set forth on the last page of this document, and at www.bourns.com/docs/legal/disclaimer.pdf.

APPLICATIONS INFORMATION

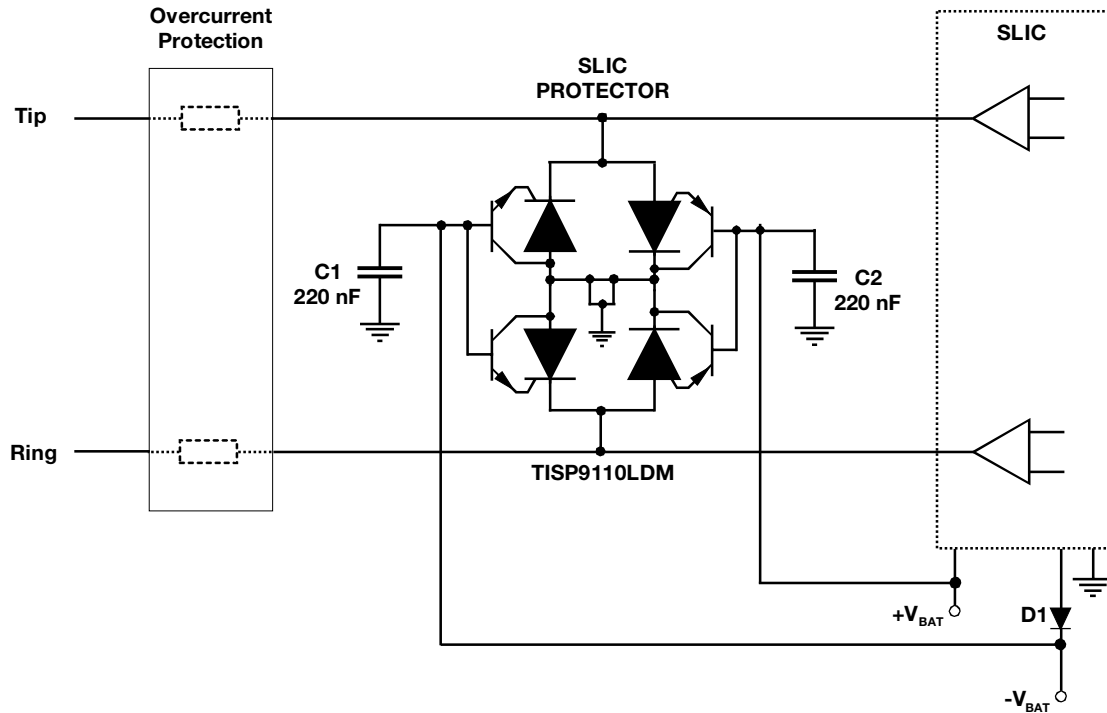

Figure 4. Typical Application Diagram

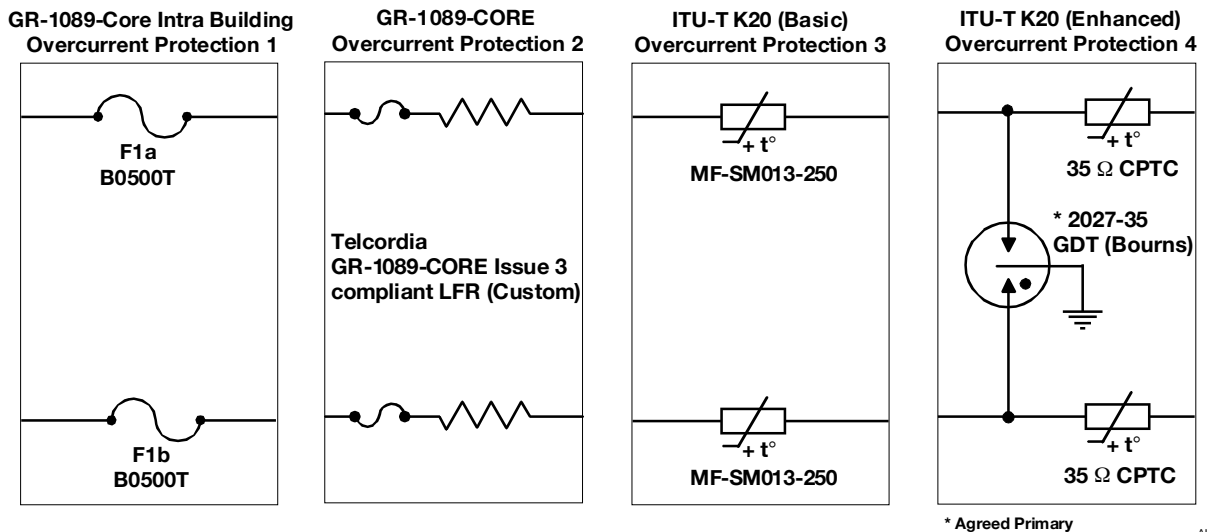

Figure 5. Typical Overcurrent Protection

AUGUST 2004 – REVISED JULY 2019

"TISP" is a trademark of Bourns, Ltd., a Bourns Company, and is registered in the U.S. Patent and Trademark Office. "Bourns" is a registered trademark of Bourns, Inc. in the U.S. and other countries.

Specifications are subject to change without notice.

Users should verify actual device performance in their specific applications.

The products described herein and this document are subject to specific legal disclaimers as set forth on the last page of this document, and at www.bourns.com/docs/legal/disclaimer.pdf.

This legal disclaimer applies to purchasers and users of Bourns® products manufactured by or on behalf of Bourns, Inc. and its affiliates (collectively, “Bourns”).

Unless otherwise expressly indicated in writing, Bourns® products and data sheets relating thereto are subject to change without notice. Users should check for and obtain the latest relevant information and verify that such information is current and complete before placing orders for Bourns® products.

The characteristics and parameters of a Bourns® product set forth in its data sheet are based on laboratory conditions, and statements regarding the suitability of products for certain types of applications are based on Bourns’ knowledge of typical requirements in generic applications. The characteristics and parameters of a Bourns® product in a user application may vary from the data sheet characteristics and parameters due to (i) the combination of the Bourns® product with other components in the user’s application, or (ii) the environment of the user application itself. The characteristics and parameters of a Bourns® product also can and do vary in different applications and actual performance may vary over time. Users should always verify the actual performance of the Bourns® product in their specific devices and applications, and make their own independent judgments regarding the amount of additional test margin to design into their device or application to compensate for differences between laboratory and real world conditions.

Unless Bourns has explicitly designated an individual Bourns® product as meeting the requirements of a particular industry standard (e.g., ISO/TS 16949) or a particular qualification (e.g., UL listed or recognized), Bourns is not responsible for any failure of an individual Bourns® product to meet the requirements of such industry standard or particular qualification. Users of Bourns® products are responsible for ensuring compliance with safety-related requirements and standards applicable to their devices or applications.

Bourns® products are not recommended, authorized or intended for use in nuclear, lifesaving, life-critical or life-sustaining applications, nor in any other applications where failure or malfunction may result in personal injury, death, or severe property or environmental damage. Unless expressly and specifically approved in writing by two authorized Bourns representatives on a case-by-case basis, use of any Bourns® products in such unauthorized applications might not be safe and thus is at the user’s sole risk. Life-critical applications include devices identified by the U.S. Food and Drug Administration as Class III devices and generally equivalent classifications outside of the United States.

Bourns expressly identifies those Bourns® standard products that are suitable for use in automotive applications on such products’ data sheets in the section entitled “Applications.” Unless expressly and specifically approved in writing by two authorized Bourns representatives on a case-by-case basis, use of any other Bourns® standard products in an automotive application might not be safe and thus is not recommended, authorized or intended and is at the user’s sole risk. If Bourns expressly identifies a sub-category of automotive application in the data sheet for its standard products (such as infotainment or lighting), such identification means that Bourns has reviewed its standard product and has determined that if such Bourns® standard product is considered for potential use in automotive applications, it should only be used in such sub-category of automotive applications. Any reference to Bourns® standard product in the data sheet as compliant with the AEC-Q standard or “automotive grade” does not by itself mean that Bourns has approved such product for use in an automotive application.

Bourns® standard products are not tested to comply with United States Federal Aviation Administration standards generally or any other generally equivalent governmental organization standard applicable to products designed or manufactured for use in aircraft or space applications. Bourns expressly identifies Bourns® standard products that are suitable for use in aircraft or space applications on such products’ data sheets in the section entitled “Applications.” Unless expressly and specifically approved in writing by two authorized Bourns representatives on a case-by-case basis, use of any other Bourns® standard product in an aircraft or space application might not be safe and thus is not recommended, authorized or intended and is at the user’s sole risk.

The use and level of testing applicable to Bourns® custom products shall be negotiated on a case-by-case basis by Bourns and the user for which such Bourns® custom products are specially designed. Absent a written agreement between Bourns and the user regarding the use and level of such testing, the above provisions applicable to Bourns® standard products shall also apply to such Bourns® custom products.

Users shall not sell, transfer, export or re-export any Bourns® products or technology for use in activities which involve the design, development, production, use or stockpiling of nuclear, chemical or biological weapons or missiles, nor shall they use Bourns® products or technology in any facility which engages in activities relating to such devices. The foregoing restrictions apply to all uses and applications that violate national or international prohibitions, including embargos or international regulations. Further, Bourns® products and Bourns technology and technical data may not under any circumstance be exported or re-exported to countries subject to international sanctions or embargoes. Bourns® products may not, without prior authorization from Bourns and/or the U.S. Government, be resold, transferred, or re-exported to any party not eligible to receive U.S. commodities, software, and technical data.

To the maximum extent permitted by applicable law, Bourns disclaims (i) any and all liability for special, punitive, consequential, incidental or indirect damages or lost revenues or lost profits, and (ii) any and all implied warranties, including implied warranties of fitness for particular purpose, non-infringement and merchantability.

For your convenience, copies of this Legal Disclaimer Notice with German, Spanish, Japanese, Traditional Chinese and Simplified Chinese bilingual versions are available at:

Web Page: <http://www.bourns.com/legal/disclaimers-terms-and-policies>

PDF: <http://www.bourns.com/docs/Legal/disclaimer.pdf>

Mouser Electronics

Authorized Distributor

Click to View Pricing, Inventory, Delivery & Lifecycle Information:

Bourns:

[TISP9110LDMR-S](#)