

DATE	REV.	ECN	APP'D BY
2-17-15	D1	10260	ADB
2-9-16	D2	10531	TRM

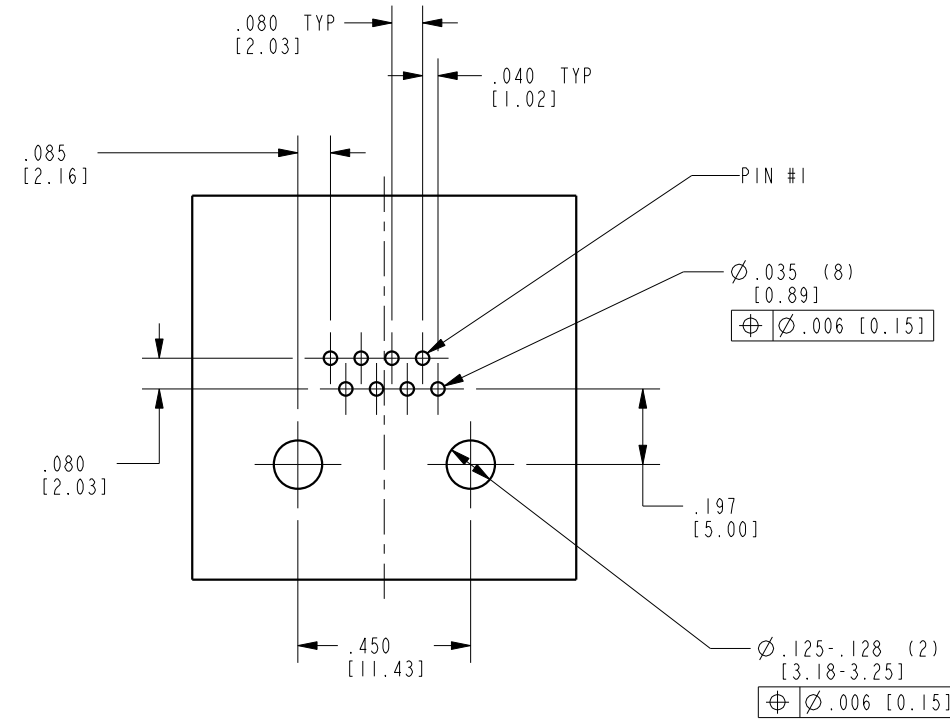
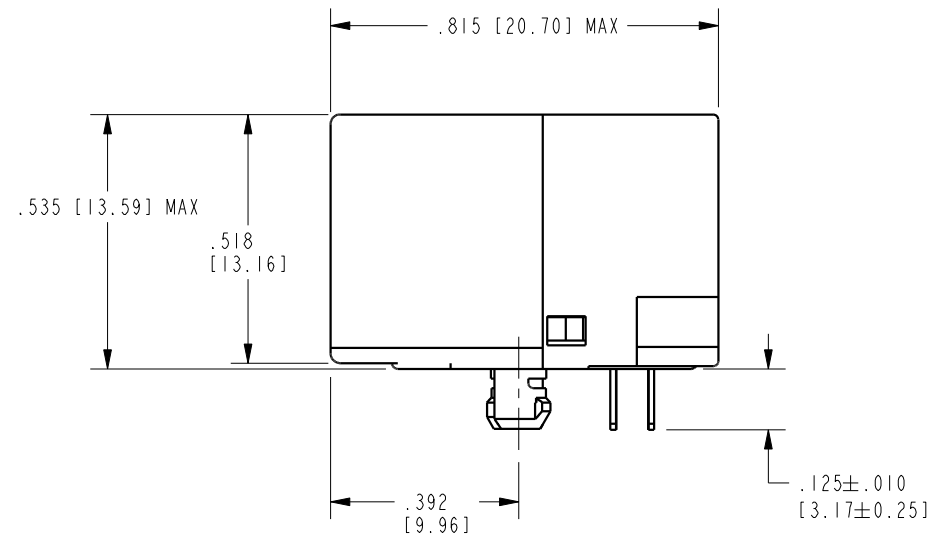
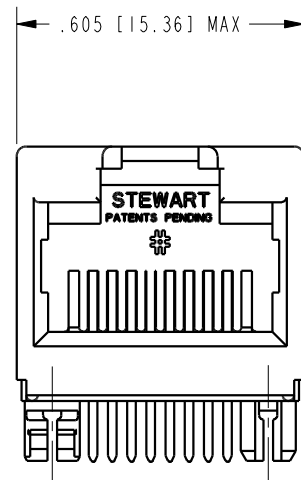

RECOMMENDED PCB HOLE LAYOUT
SEEN FROM COMPONENT SIDE
ALL CENTERLINE DIMENSIONS ARE BASIC

NOTES:

- MATERIALS:
HOUSING -- THERMOPLASTIC UL 94-V0
CONTACTS -- COPPER ALLOY
CONTACT PLATING -- SELECTIVE PLATING IN CONTACT AREA
SEE CHART FOR DETAILS
- PRODUCT DESIGNED FOR CAT6 APPLICATIONS
- DIMENSIONS AND TOLERANCES COMPLY WITH TIA-1096 STANDARD.

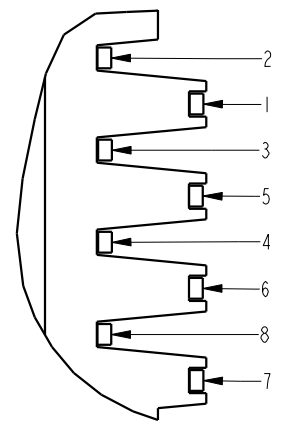

DETAIL M
OUTPUT PIN DESIGNATIONS

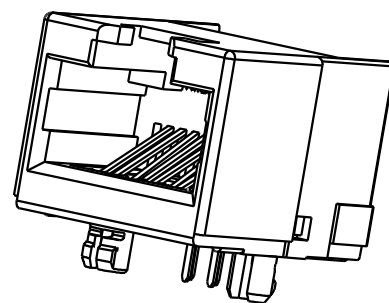
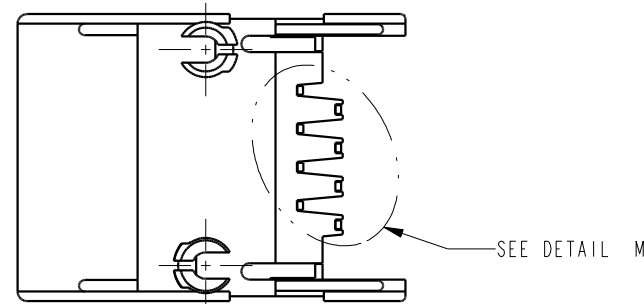

50 MICRO-INCHES [1.27µm] Au OR 5 MICRO-INCHES [0.13µm] Au OVER 30 MICRO-INCHES [0.76µm]PdNi	SS-60000-010
CONTACT PLATING IN MATING AREA	PART NUMBER

THIRD ANGLE PROJECTION

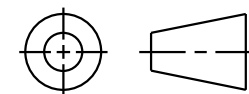

11118 Susquehanna Trail South
Glen Rock, PA 17327-9199
(717) 235-7512
<http://www.stewartconnector.com>

DO NOT SCALE DRAWING

DRAWING IS SUBJECT TO CHANGE WITHOUT NOTICE

DIMENSIONS: INCHES [METRIC]

UNLESS OTHERWISE SPECIFIED
TOLERANCES ARE ±.005 [0.13]
ANGLES ARE ±1°

SHEET NO.
1 OF 1

60 SERIES UNSHIELDED RIGHT ANGLE JACK

THIS DRAWING AND THE SUBJECT MATTER SHOWN THEREON ARE CONFIDENTIAL AND THE PROPRIETARY PROPERTY OF STEWART CONNECTOR AND SHALL NOT BE REPRODUCED, COPIED, OR USED IN ANY MANNER WITHOUT PRIOR WRITTEN CONSENT OF STEWART CONNECTOR. ONE OR MORE U.S. PATENTS MAY APPLY TO THIS PRODUCT. FOR DETAILS, PLEASE VISIT: [HTTP://BELFUSE.COM/STEWART/STEWART_PATENTS/](http://BELFUSE.COM/STEWART/STEWART_PATENTS/)

DRN BY:	JRC	DATE	04-14-04
APPD BY:	RGC	DATE	04-14-04
DWG. NO.	CT600025	REV.	D2