

FEATURES

- Input start-up voltage range: 2.15 V to 6.50 V
- Operates down to 2.00 V voltage
- Ultralow 180 nA quiescent current with no load
- Selectable output voltage of 1.2 V to 3.6 V or 0.8 V to 5.0 V
- ±1.5% output accuracy over full temperature range in PWM mode
- Selectable hysteresis mode or PWM operation mode
- Output current
 - Up to 50 mA in hysteresis mode
 - Up to 500 mA in PWM mode
- VOUTOK flag monitors the output voltage
- 100% duty cycle operation mode
- 2 MHz switching frequency with optional synchronization input from 1.5 MHz to 2.5 MHz
- QOD option
- UVLO, OCP, and TSD protection
- 9-ball, 1.65 mm × 1.87 mm WLCSP
- −40°C to +125°C junction temperature

APPLICATIONS

- Energy (gas and water) metering
- Portable and battery-powered equipment
- Medical applications
- Keep-alive power supplies

GENERAL DESCRIPTION

The **ADP5301** is a high efficiency, ultralow quiescent current step-down regulator that draws only a 180 nA quiescent current to regulate the output at no load.

The **ADP5301** runs from an input startup voltage range of 2.15 V to 6.50 V, allowing the use of multiple alkaline/NiMH, Li-Ion cells, or other power sources. The output voltage is selectable from 0.8 V to 5.0 V by an external VID resistor and factory fuse. The total solution requires only four tiny external components.

The **ADP5301** can operate between hysteresis mode and PWM mode via the SYNC/MODE pin. The regulator in hysteresis mode achieves excellent efficiency at a power of less than 1 mW and provides up to 50 mA of output current. The regulator in PWM mode produces a lower output ripple and supplies up to 500 mA of output current. The flexible configuration capability during operation of the device enables very efficient power management to meet both the longest battery life and low system noise requirements.

TYPICAL APPLICATION CIRCUIT

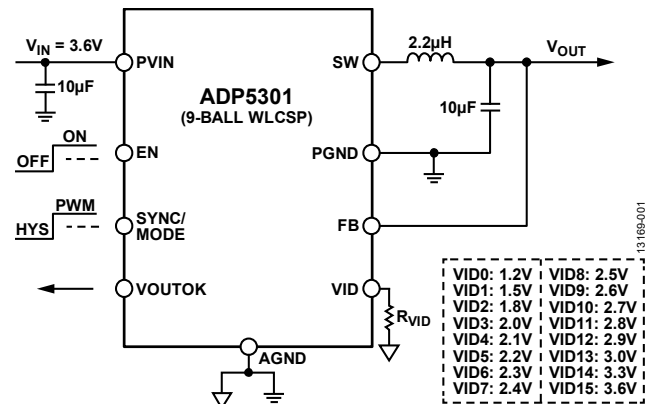

Figure 1.

The **ADP5301** contains a VOUTOK flag, which monitors the output voltage and runs at a 2 MHz switching frequency in PWM mode. SYNC/MODE can synchronize to an external clock from 1.5 MHz to 2.5 MHz.

Other key features in the **ADP5301** include separate enabling, quick output discharge (QOD), and safety features such as overcurrent protection (OCP), thermal shutdown (TSD), and input undervoltage lockout (UVLO).

The **ADP5301** is available in a 9-ball, 1.65 mm × 1.87 mm WLCSP rated for a −40°C to +125°C junction temperature range.

Rev. C

[Document Feedback](#)

Information furnished by Analog Devices is believed to be accurate and reliable. However, no responsibility is assumed by Analog Devices for its use, nor for any infringements of patents or other rights of third parties that may result from its use. Specifications subject to change without notice. No license is granted by implication or otherwise under any patent or patent rights of Analog Devices. Trademarks and registered trademarks are the property of their respective owners.

One Technology Way, P.O. Box 9106, Norwood, MA 02062-9106, U.S.A.
 Tel: 781.329.4700 ©2015–2019 Analog Devices, Inc. All rights reserved.
[Technical Support](#) www.analog.com

TABLE OF CONTENTS

Features	1	Short-Circuit Protection.....	15
Applications.....	1	Soft Start	15
Typical Application Circuit	1	Startup with a Precharged Output	15
General Description	1	100% Duty Cycle Operation	15
Revision History	2	Active Discharge.....	15
Functional Block Diagram	3	VOUOK Function	15
Specifications.....	4	Thermal Shutdown	15
Absolute Maximum Ratings.....	6	Applications Information	16
Thermal Resistance	6	External Component Selection	16
ESD Caution.....	6	Selecting the Inductor.....	16
Pin Configuration and Function Descriptions.....	7	Output Capacitor.....	16
Typical Performance Characteristics	8	Input Capacitor.....	17
Theory of Operation	14	Efficiency	17
Buck Regulator Operation Modes.....	14	Printed Circuit Board (PCB) Layout Recommendations	18
Oscillator and Synchronization	14	Typical Application Circuits	19
Adjustable and Fixed Output Voltages	14	Factory Programmable Options.....	20
Undervoltage Lockout (UVLO)	15	Outline Dimensions	21
Enable/Disable	15	Ordering Guide	21
Current Limit	15		

REVISION HISTORY

7/2019—Rev. B to Rev. C

Changes to Adjustable and Fixed Output Voltages Section.....	15
Changes to Table 8, Table 9, and Table 10	20
Changes to Ordering Guide	21
Updated Outline Dimensions	21

6/2016—Rev. A to Rev. B

Changes to Features Section and General Description.....	1
Change to SYNC Clock Range Parameter, Table 1	4

Change to Table 4	7
Change to Oscillator and Synchronization Section	14
Changes to Table 8.....	20

12/2015—Rev. 0 to Rev. A

Changes to Ordering Guide	21
---------------------------------	----

6/2015—Revision 0: Initial Version

FUNCTIONAL BLOCK DIAGRAM

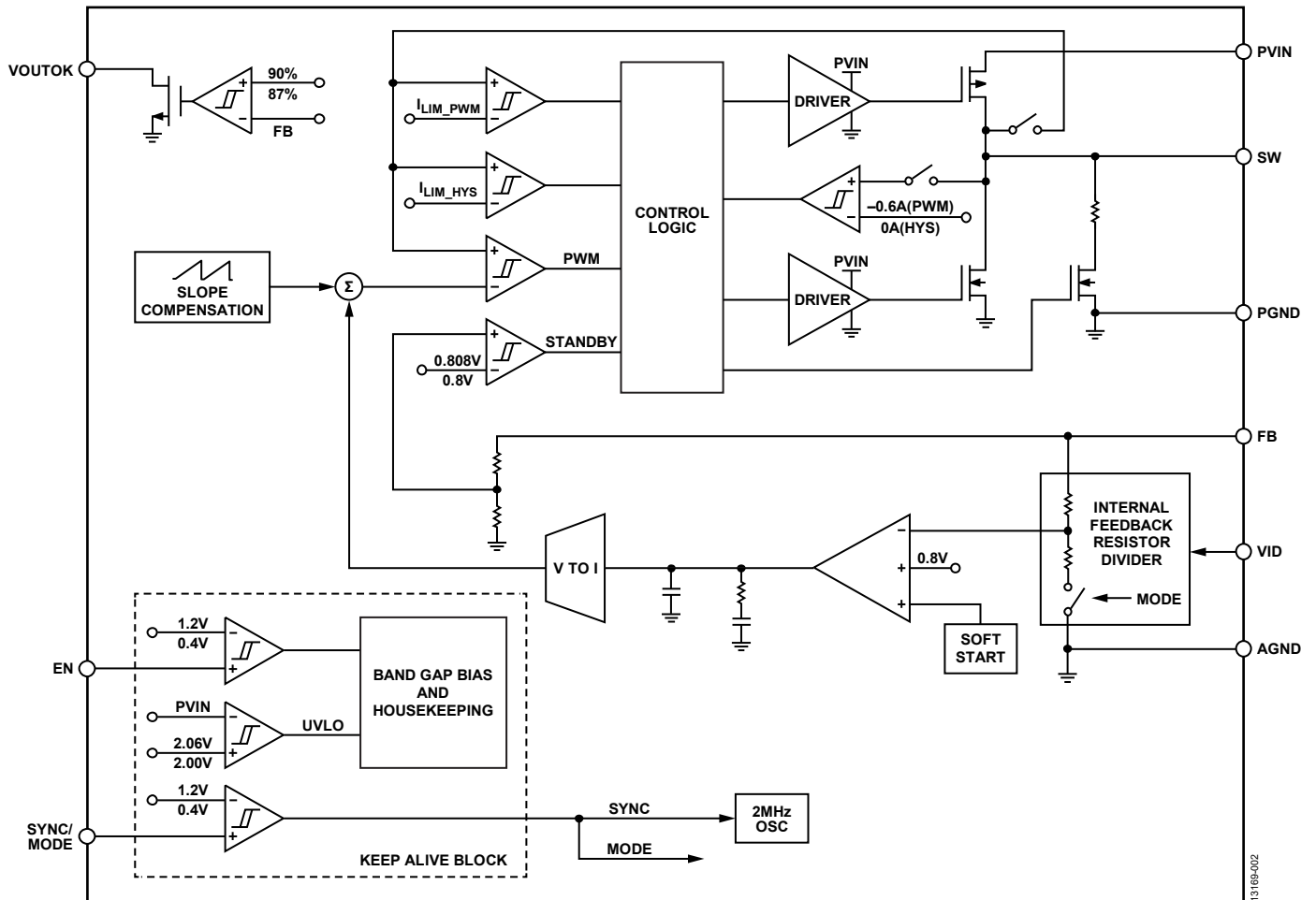

Figure 2.

13169-002

SPECIFICATIONS

$V_{IN} = 3.6\text{ V}$, $V_{OUT} = 2.5\text{ V}$, $T_J = -40^\circ\text{C}$ to $+125^\circ\text{C}$ for minimum and maximum specifications, and $T_A = 25^\circ\text{C}$ for typical specifications, unless otherwise noted.

Table 1.

Parameter	Symbol	Min	Typ	Max	Unit	Test Conditions/Comments
INPUT SUPPLY VOLTAGE RANGE	V_{IN}	2.15		6.50	V	
SHUTDOWN CURRENT	$I_{SHUTDOWN}$		18	40	nA	$V_{EN} = 0\text{ V}$, $-40^\circ\text{C} \leq T_J \leq +85^\circ\text{C}$
			18	130	nA	$V_{EN} = 0\text{ V}$, $-40^\circ\text{C} \leq T_J \leq +125^\circ\text{C}$
QUIESCENT CURRENT						
Operating Quiescent Current in Hysteresis Mode	I_{Q_HYS}		180	260	nA	$-40^\circ\text{C} \leq T_J \leq +85^\circ\text{C}$
			180	350	nA	$-40^\circ\text{C} \leq T_J \leq +125^\circ\text{C}$
			570	1400	nA	100% duty cycle operation, $V_{IN} = 3.0\text{ V}$, V_{OUT} set to 3.3 V
Operating Quiescent Current in PWM Mode	I_{Q_PWM}		425	630	μA	
UNDERVOLTAGE LOCKOUT	UVLO					
UVLO Threshold						
Rising	V_{UVLO_RISING}		2.06	2.14	V	
Falling	$V_{UVLO_FALLING}$	1.90	2.00		V	
OSCILLATOR CIRCUIT						
Switching Frequency in PWM Mode	f_{SW}	1.7	2.0	2.3	MHz	
FB Threshold of Frequency Fold	V_{OSC_FOLD}		0.3		V	
SYNCHRONIZATION THRESHOLD						
SYNC Clock Range	$SYNC_{CLOCK}$	1.5		2.5	MHz	
SYNC High Level Threshold	$SYNC_{HIGH}$	1.2			V	
SYNC Low Level Threshold	$SYNC_{LOW}$			0.4	V	
SYNC Duty Cycle Range	$SYNC_{DUTY}$	100		$1/f_{SW} - 150$	ns	
SYNC/MODE Leakage Current	$I_{SYNC_LEAKAGE}$		50	150	nA	$V_{SYNC/MODE} = 3.6\text{ V}$
MODE TRANSITION						
Transition Delay from Hysteresis Mode to PWM Mode	$t_{HYS_TO_PWM}$		20		Clock cycles	SYNC/MODE goes logic high from logic low
EN PIN						
Input Voltage Threshold						
High	V_{IH}	1.2			V	
Low	V_{IL}			0.4	V	
Input Leakage Current	$I_{EN_LEAKAGE}$			25	nA	
FB PIN						
Output Options by VID Resistor	V_{OUT_OPT}	0.8		5.0	V	0.8 V to 5.0 V in various factory options
PWM Mode						
Fixed VID Code Voltage Accuracy	$V_{FB_PWM_FIX}$	-0.6		+0.6	%	$T_J = 25^\circ\text{C}$, output voltage setting via factory fuse
		-1.2		+1.2	%	$-40^\circ\text{C} \leq T_J \leq +125^\circ\text{C}$
Adjustable VID Code Voltage Accuracy	$V_{FB_PWM_ADJ}$	-1.5		+1.5	%	Output voltage setting via VID resistor
Hysteresis Mode						
Fixed VID Code Threshold Accuracy from Active Mode to Standby Mode	$V_{FB_HYS_FIX}$	-0.75		+0.75	%	$T_J = 25^\circ\text{C}$
		-2.5		+2.5	%	$-40^\circ\text{C} \leq T_J \leq +125^\circ\text{C}$
Adjustable VID Code Threshold Accuracy from Active Mode to Standby Mode	$V_{FB_HYS_ADJ}$	-3		+3	%	$-40^\circ\text{C} \leq T_J \leq +125^\circ\text{C}$
Hysteresis of Threshold Accuracy from Active Mode to Standby Mode	$V_{FB_HYS (HYS)}$		1		%	
Feedback Bias Current	I_{FB}		66	95	nA	Output Option 0, $V_{OUT} = 2.5\text{ V}$
			25	45	nA	Output Option 1, $V_{OUT} = 1.3\text{ V}$

Parameter	Symbol	Min	Typ	Max	Unit	Test Conditions/Comments
SW PIN						
High-Side Power FET On Resistance	$R_{DS(ON)H}$		324	470	m Ω	Pin to pin measurement
Low-Side Power FET On Resistance	$R_{DS(ON)L}$		196	320	m Ω	Pin to pin measurement
Current-Limit in PWM Mode	I_{LIM_PWM}	800	1000	1200	mA	SYNC/MODE = high
Peak Current in Hysteresis Mode	I_{LIM_HYS}		265		mA	SYNC/MODE = low
Minimum On Time	t_{MIN_ON}		40	70	ns	
VOUTOK PIN						
Monitor Threshold	$V_{OUTOK(RISE)}$	87	90	93	%	
Monitor Hysteresis	$V_{OUTOK(HYS)}$		3		%	
Monitor Rising Delay	t_{VOUTOK_RISE}		40		μ s	
Monitor Falling Delay	t_{VOUTOK_FALL}		10		μ s	
Leakage Current	$I_{VOUTOK_LEAKAGE}$		0.1	1	μ A	
Output Low Voltage	V_{OUTOK_LOW}		50	80	mV	$I_{VOUTOK} = 100 \mu$ A
SOFT START						
Default Soft Start Time	t_{SS}		350		μ s	Factory trim, 1 bit (350 μ s and 2800 μ s)
Start-Up Delay	t_{START_DELAY}		2		ms	Delay from the EN pin being pulled high
C_{OUT} DISCHARGE SWITCH ON RESISTANCE	R_{DIS}		290		Ω	
THERMAL SHUTDOWN						
Threshold	T_{SHDN}		142		$^{\circ}$ C	
Hysteresis	T_{HYS}		127		$^{\circ}$ C	

ABSOLUTE MAXIMUM RATINGS

Table 2.

Parameter	Rating
PVIN to PGND	-0.3 V to +7 V
SW to PGND	-0.3 V to PVIN + 0.3 V
FB to AGND	-0.3 V to +7 V
VID to AGND	-0.3 V to +7 V
EN to AGND	-0.3 V to +7 V
VOUOK to AGND	-0.3 V to +7 V
SYNC/MODE to AGND	-0.3 V to +7 V
PGND to AGND	-0.3 V to +0.3 V
Storage Temperature Range	-65°C to +150°C
Operational Junction Temperature Range	-40°C to +125°C

Stresses at or above those listed under Absolute Maximum Ratings may cause permanent damage to the product. This is a stress rating only; functional operation of the product at these or any other conditions above those indicated in the operational section of this specification is not implied. Operation beyond the maximum operating conditions for extended periods may affect product reliability.

THERMAL RESISTANCE

θ_{JA} is specified for the worst case conditions, that is, a device soldered in a circuit board for surface-mount packages.

Table 3. Thermal Resistance

Package Type	θ_{JA}	Unit
9-Ball WLCSP	132	°C/W

ESD CAUTION



ESD (electrostatic discharge) sensitive device.

Charged devices and circuit boards can discharge without detection. Although this product features patented or proprietary protection circuitry, damage may occur on devices subjected to high energy ESD. Therefore, proper ESD precautions should be taken to avoid performance degradation or loss of functionality.

PIN CONFIGURATION AND FUNCTION DESCRIPTIONS

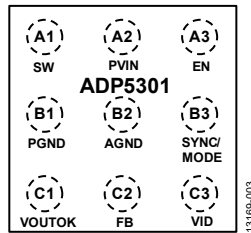

Figure 3. Pin Configuration (Top View)

Table 4. Pin Function Descriptions

Pin No.	Mnemonic	Description
A1	SW	Switching Node Output for the Regulator.
A2	PVIN	Power Input for the Regulator.
A3	EN	Enable Input for the Regulator. Set this pin to logic low to disable the regulator.
B1	PGND	Power Ground.
B2	AGND	Analog Ground.
B3	SYNC/MODE	Synchronization Input Pin (SYNC). To synchronize the switching frequency of the device to an external clock, connect this pin to an external clock with a frequency from 1.5 MHz to 2.5 MHz. PWM or Hysteresis Mode Selection Pin (MODE). When this pin is logic high, the regulator operates in PWM mode. When this pin is logic low, the regulator operates in hysteresis mode.
C1	VOUTOK	Output Power-Good Signal. This open-drain output is the power-good signal for the output voltage.
C2	FB	Feedback Sensing Input for the Regulator.
C3	VID	Voltage Configuration Pin. Connect an external resistor (R_{VID}) from this pin to ground to configure the output voltage of the regulator (see Table 5).

TYPICAL PERFORMANCE CHARACTERISTICS

$V_{IN} = 3.6\text{ V}$, $V_{OUT} = 2.5\text{ V}$, $L = 2.2\ \mu\text{H}$, $C_{IN} = C_{OUT} = 10\ \mu\text{F}$, $f_{SW} = 2\text{ MHz}$, $T_A = 25^\circ\text{C}$, unless otherwise noted.

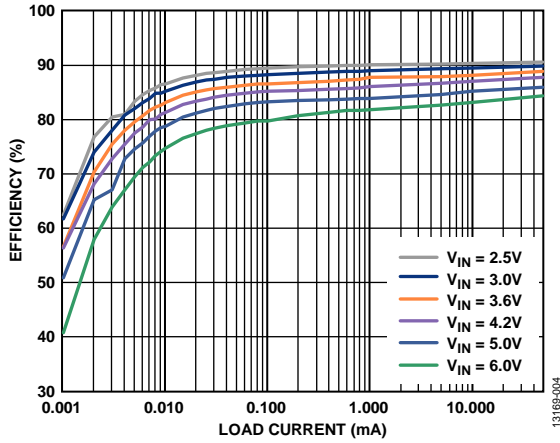

Figure 4. Hysteresis Efficiency vs. Load Current, $V_{OUT} = 1.2\text{ V}$

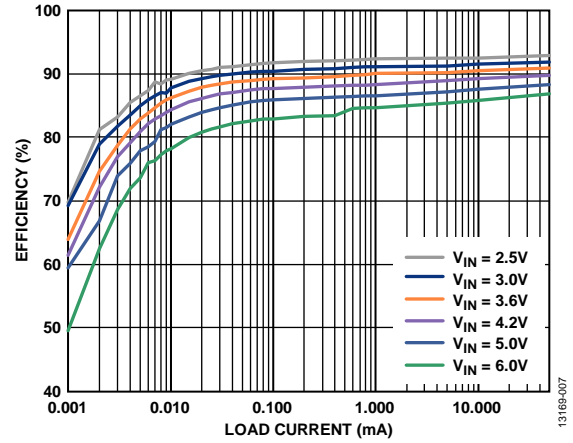

Figure 7. Hysteresis Efficiency vs. Load Current, $V_{OUT} = 1.5\text{ V}$

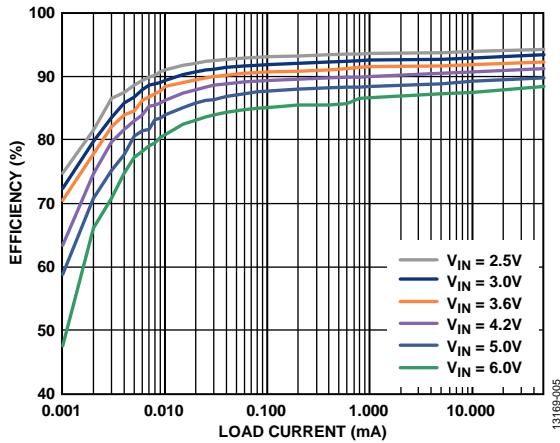

Figure 5. Hysteresis Efficiency vs. Load Current, $V_{OUT} = 1.8\text{ V}$

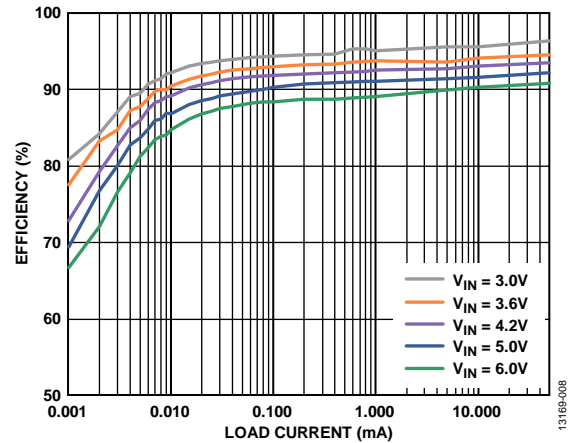

Figure 8. Hysteresis Efficiency vs. Load Current, $V_{OUT} = 2.5\text{ V}$

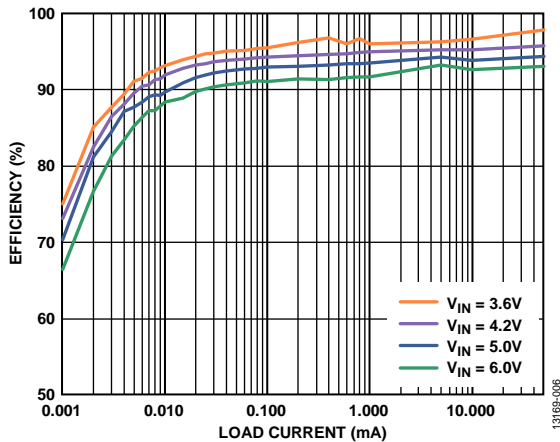

Figure 6. Hysteresis Efficiency vs. Load Current, $V_{OUT} = 3.3\text{ V}$

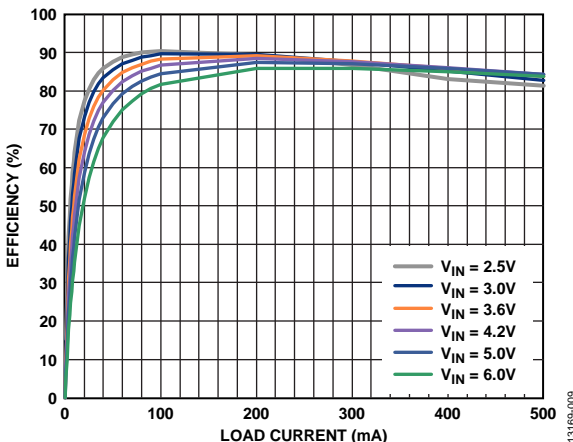

Figure 9. PWM Efficiency vs. Load Current, $V_{OUT} = 1.2\text{ V}$

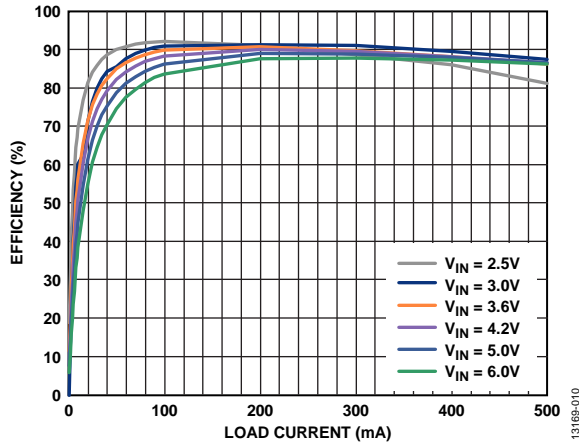

Figure 10. PWM Efficiency vs. Load Current, $V_{OUT} = 1.5 V$

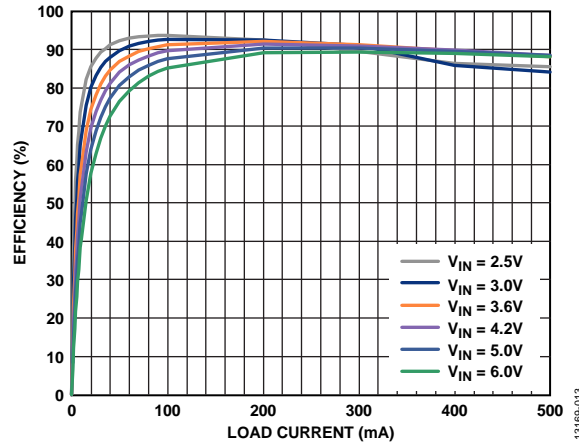

Figure 13. PWM Efficiency vs. Load Current, $V_{OUT} = 1.8 V$

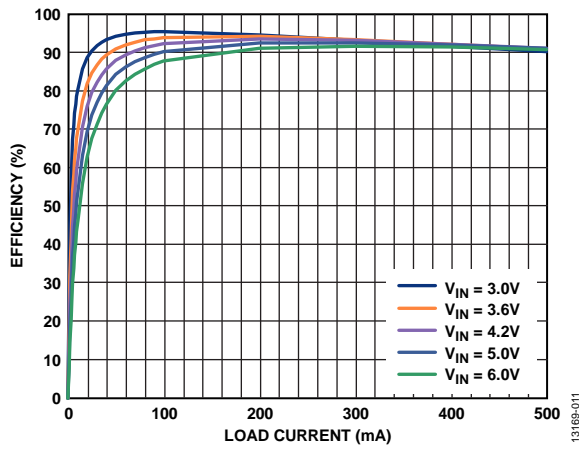

Figure 11. PWM Efficiency vs. Load Current, $V_{OUT} = 2.5 V$

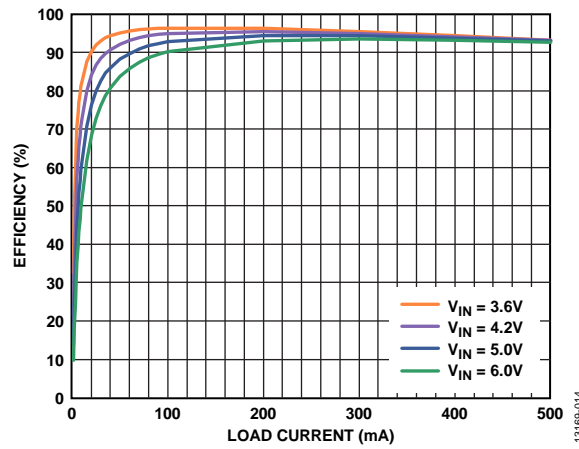

Figure 14. PWM Efficiency vs. Load Current, $V_{OUT} = 3.3 V$

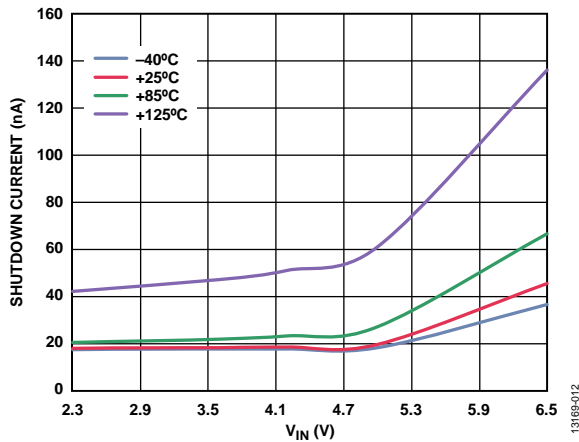

Figure 12. Shutdown Current vs. V_{IN} , $EN = Low$

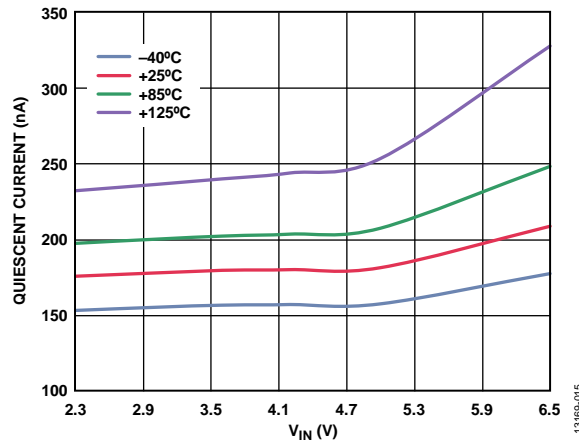

Figure 15. Hysteresis Quiescent Current vs. V_{IN} , $SYNC/MODE = Low$

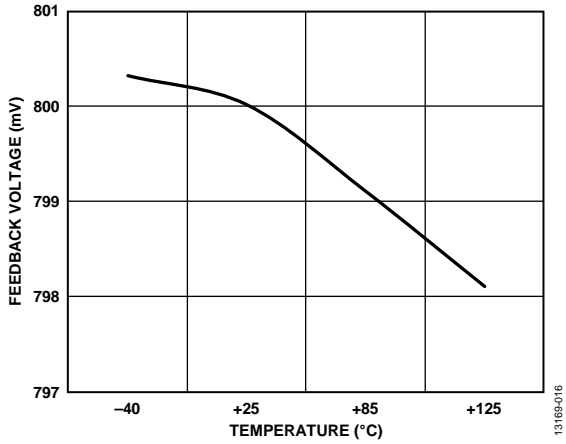

Figure 16. Feedback Voltage vs. Temperature, PWM Mode

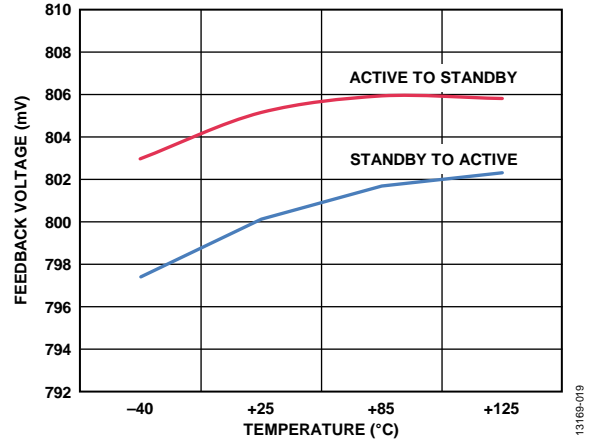

Figure 19. Feedback Voltage vs. Temperature, Hysteresis Mode

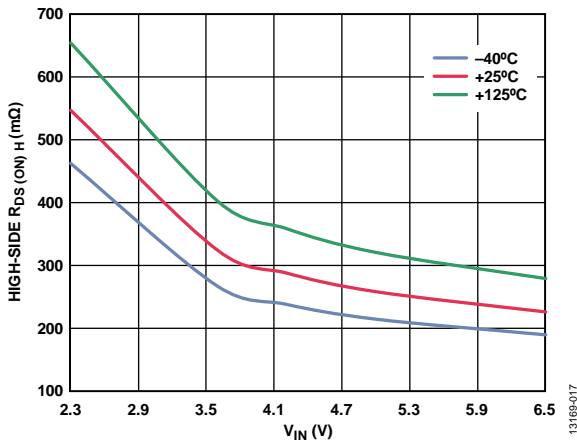

Figure 17. High-Side $R_{DS(ON)H}$ vs. V_{IN}

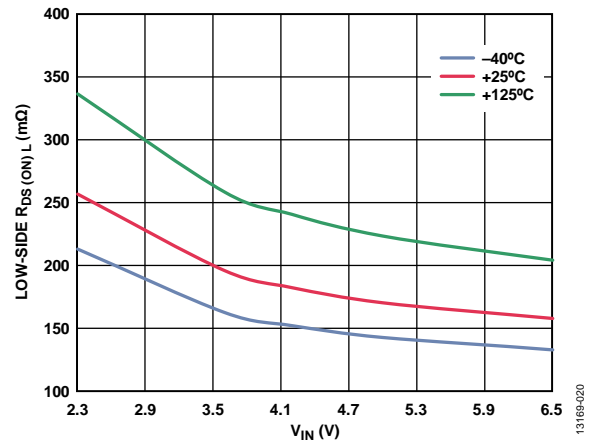

Figure 20. Low-Side $R_{DS(ON)L}$ vs. V_{IN}

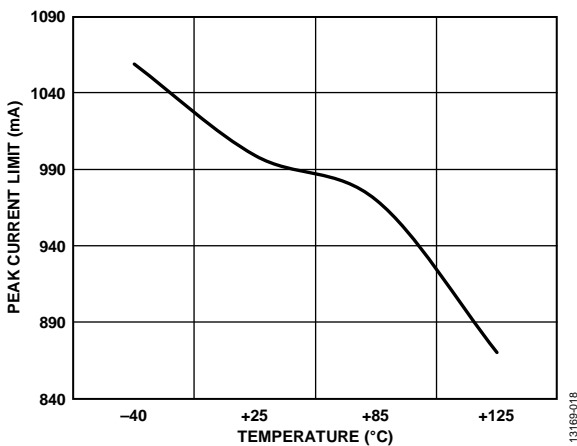

Figure 18. Peak Current Limit vs. Temperature

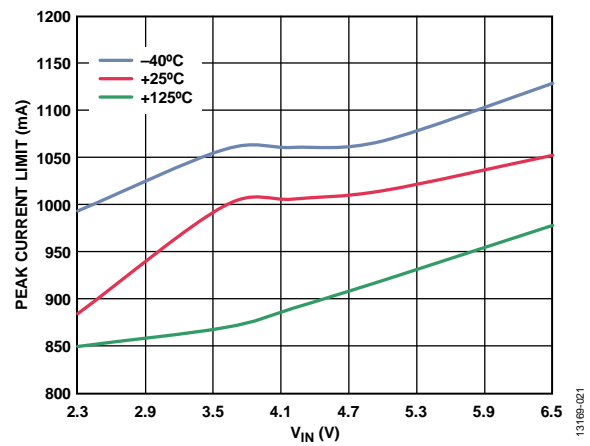

Figure 21. Peak Current Limit vs. V_{IN}

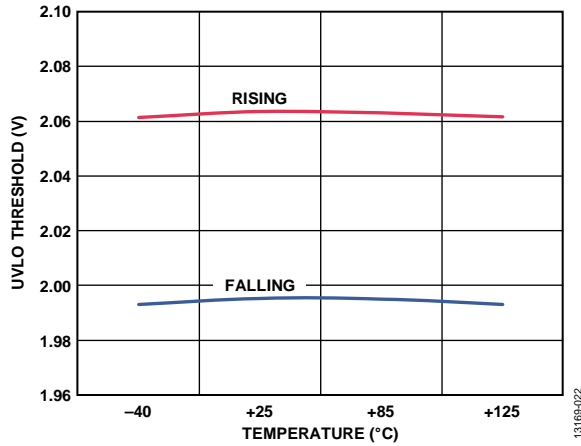

Figure 22. UVLO Threshold, Rising and Falling vs. Temperature

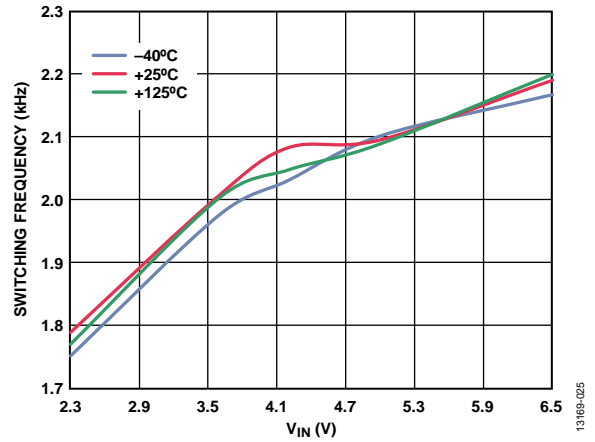

Figure 25. Switching Frequency vs. V_{IN}

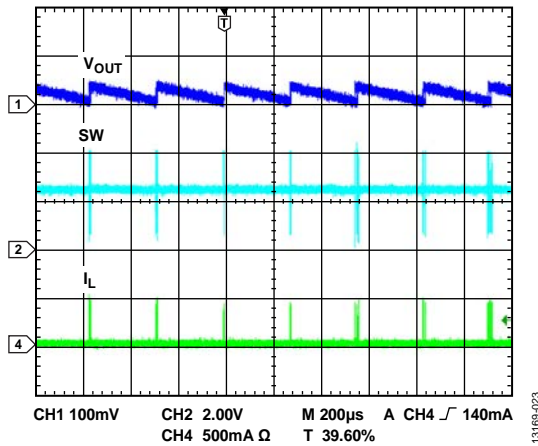

Figure 23. Steady Waveform of Hysteresis Mode, I_{LOAD} = 1 mA (I_L is the Inductor Current)

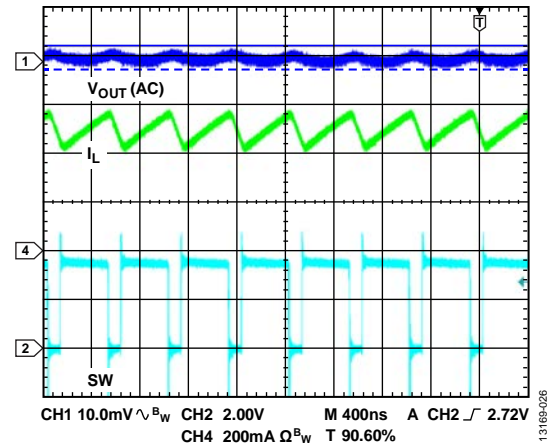

Figure 26. Steady Waveform of PWM Mode, I_{LOAD} = 300 mA

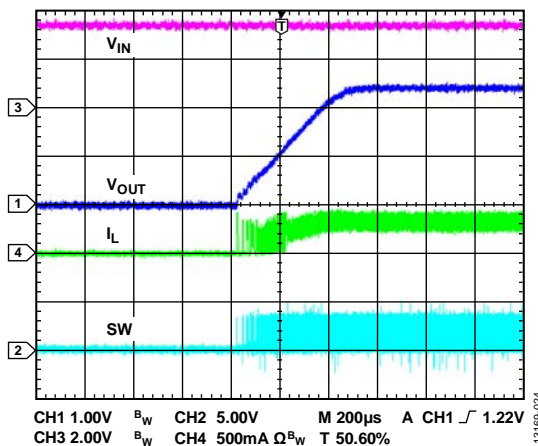

Figure 24. Soft Start, I_{LOAD} = 300 mA

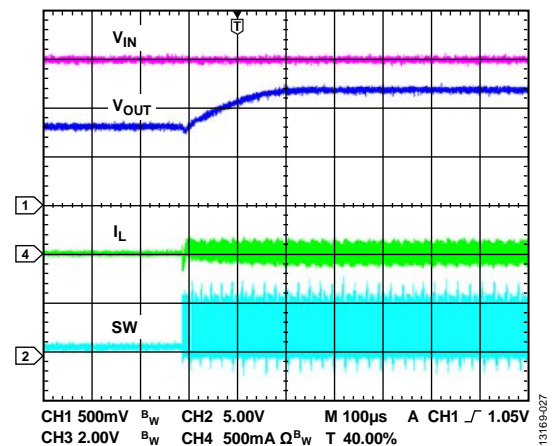

Figure 27. Soft Start with Precharge Function

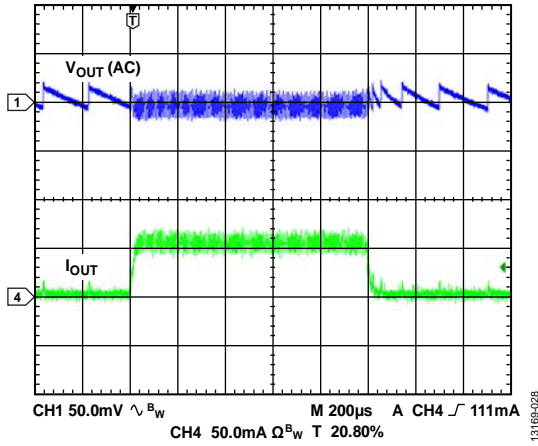

Figure 28. Load Transient of Hysteresis Mode, I_{LOAD} from 0 mA to 50 mA

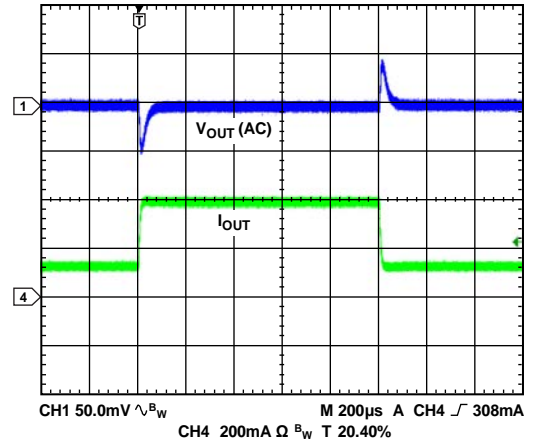

Figure 31. Load Transient of PWM Mode, I_{LOAD} from 125 mA to 375 mA

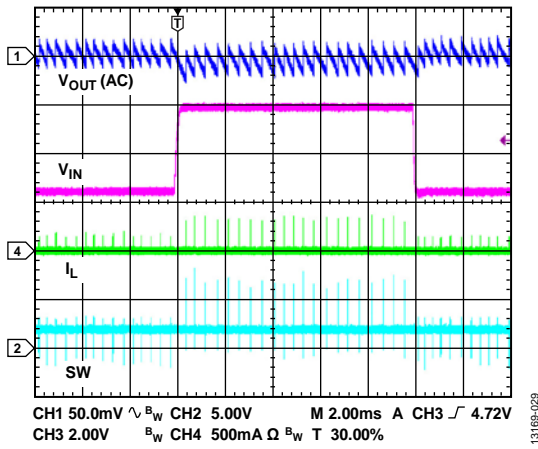

Figure 29. Line Transient of Hysteresis Mode, $I_{LOAD} = 10 \mu A$, V_{IN} from 2.5 V to 6 V

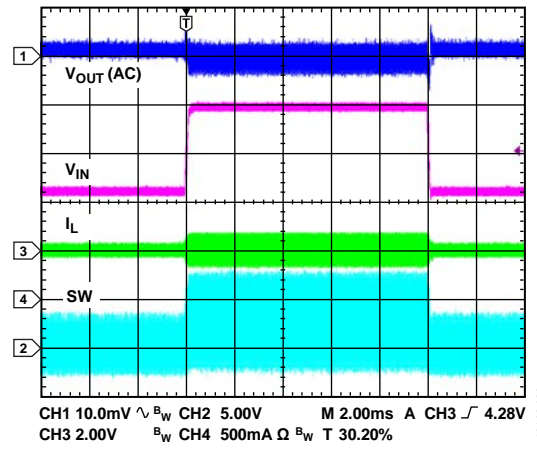

Figure 32. Line Transient of PWM Mode, $I_{LOAD} = 500 \text{ mA}$, V_{IN} from 2.5 V to 6 V

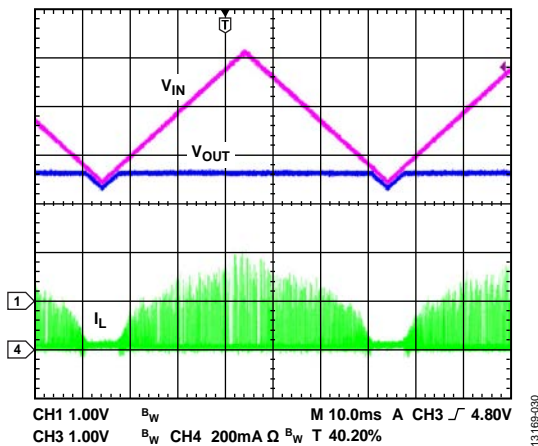

Figure 30. Input Voltage Ramp Up and Ramp Down in Hysteresis Mode

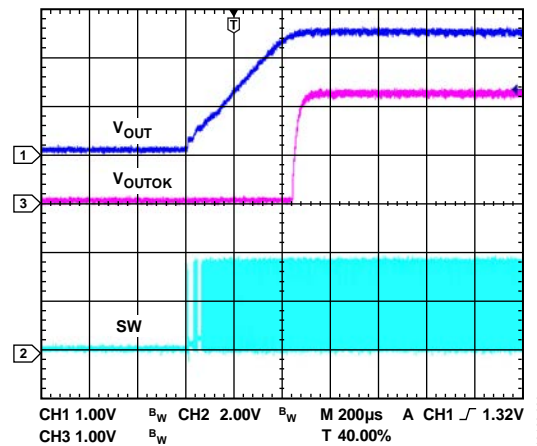

Figure 33. VOUTOK Function

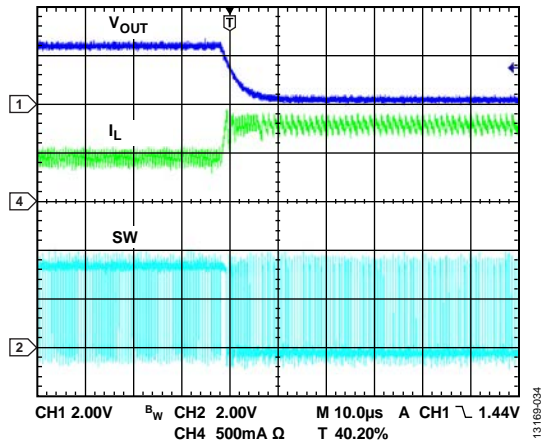

Figure 34. Output Short Protection

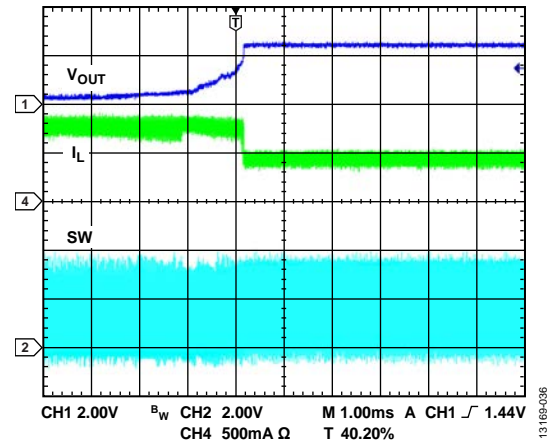

Figure 36. Output Short Recovery

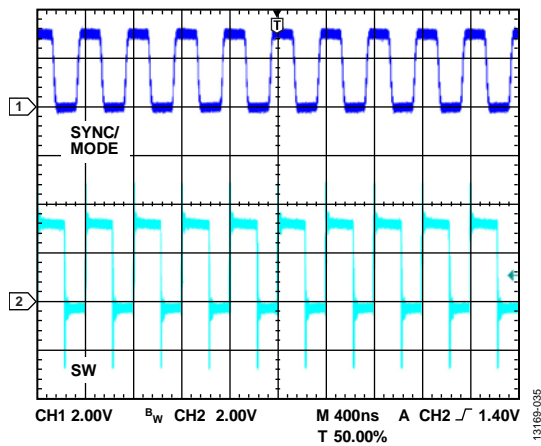

Figure 35. Synchronized to 2.5 MHz

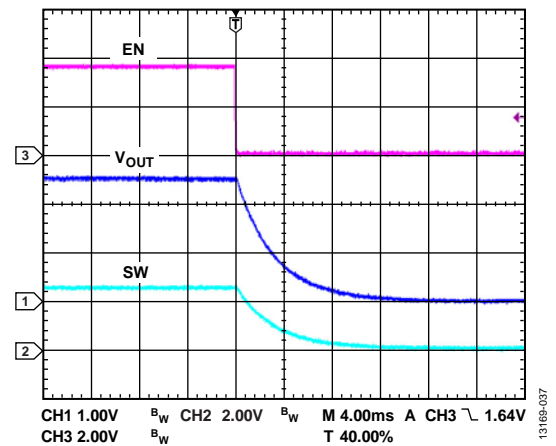

Figure 37. Quick Output Discharge Function

THEORY OF OPERATION

The **ADP5301** is a high efficiency, ultralow quiescent current step-down regulator in a 9-ball WLCSP to meet demanding performance and board space requirements. The device enables direct connection to the wide input voltage range of 2.15 V to 6.50 V, allowing the use of multiple alkaline/NiMH or Li-Ion cells and other power sources.

BUCK REGULATOR OPERATION MODES

PWM Mode

In PWM mode, the buck regulator in the **ADP5301** operates at a fixed frequency that is set by an internal oscillator. At the start of each oscillator cycle, the high-side MOSFET switch turns on and sends a positive voltage across the inductor. The inductor current increases until the current sense signal exceeds the peak inductor current threshold, which turns off the high-side MOSFET switch. This threshold is set by the error amplifier output. During the high-side MOSFET off time, the inductor current decreases through the low-side MOSFET until the next oscillator clock pulse starts a new cycle.

Hysteresis Mode

In hysteresis mode, the buck regulator in the **ADP5301** charges the output voltage slightly higher than its nominal output voltage with PWM pulses by regulating the constant peak inductor current. When the output voltage increases until the output sense signal exceeds the hysteresis upper threshold, the regulator enters standby mode. In standby mode, the high-side and low-side MOSFETs and a majority of the circuitry are disabled to allow a low quiescent current as well as high efficiency performance.

During standby mode, the output capacitor supplies energy into the load and the output voltage decreases until it falls below the hysteresis comparator lower threshold. The buck regulator wakes up and generates the PWM pulses to charge the output again.

Because the output voltage occasionally enters standby mode and then recovers, the output voltage ripple in hysteresis mode is larger than the ripple in PWM mode.

Mode Selection

The **ADP5301** includes the SYNC/MODE pin to allow flexible configuration in hysteresis mode or PWM mode.

When a logic high level is applied to the SYNC/MODE pin, the buck regulator is forced to operate in PWM mode. In PWM mode, the regulator can supply up to 500 mA of output current. The regulator can provide lower output ripple and output noise in PWM mode, which is useful for noise sensitive applications.

When a logic low level is applied to the SYNC/MODE pin, the buck regulator is forced to operate in hysteresis mode. In hysteresis mode, the regulator draws only 180 nA of quiescent current typical to regulate the output under zero load, which allows the regulator to act as a keep-alive power supply in a battery-powered system. In hysteresis mode, the regulator supplies up to 50 mA of output current with a relatively large output ripple compared to PWM mode.

The user can alternate between hysteresis mode and PWM mode during operation. The flexible configuration capability during operation of the device enables efficient power management to meet high efficiency and low output ripple requirements when the system switches between active mode and standby mode.

OSCILLATOR AND SYNCHRONIZATION

The **ADP5301** operates at a 2 MHz switching frequency typical in PWM operation mode.

The switching frequency of the **ADP5301** can be synchronized to an external clock with a frequency range from 1.5 MHz to 2.5 MHz. The **ADP5301** automatically detects the presence of an external clock applied to the SYNC/MODE pin, and the switching frequency transitions to the frequency of the external clock. When the external clock signal stops, the device automatically switches back to the internal clock.

ADJUSTABLE AND FIXED OUTPUT VOLTAGES

The **ADP5301** provides adjustable output voltage settings by connecting one resistor through the VID pin to AGND. The VID detection circuitry works in the start-up period, and the voltage ID code is sampled and held into the internal register and does not change until the next power recycle. Furthermore, the **ADP5301** provides a fixed output voltage programmed via the factory fuse. In this condition, connect the VID pin to the PVIN pin.

For the output voltage settings, the feedback resistor divider is built into the **ADP5301**, and the feedback pin (FB) must be tied directly to the output. An ultralow power voltage reference and an integrated high impedance (50 M Ω typical) feedback divider network contribute to the low quiescent current. Table 5 lists the output voltage options by the VID pin configurations.

Table 5. Output Voltage (V_{OUT}) Options Using the VID Pin

VID Configuration	V_{OUT} (V)	
	Factory Option 0	Factory Option 1
Short to Ground	3.0	3.1
Short to PVIN	2.5	1.3
$R_{VID} = 499 \text{ k}\Omega$	3.6	5.0
$R_{VID} = 316 \text{ k}\Omega$	3.3	4.5
$R_{VID} = 226 \text{ k}\Omega$	2.9	4.2
$R_{VID} = 174 \text{ k}\Omega$	2.8	3.9
$R_{VID} = 127 \text{ k}\Omega$	2.7	3.4
$R_{VID} = 97.6 \text{ k}\Omega$	2.6	3.2
$R_{VID} = 76.8 \text{ k}\Omega$	2.4	1.9
$R_{VID} = 56.2 \text{ k}\Omega$	2.3	1.7
$R_{VID} = 43 \text{ k}\Omega$	2.2	1.6
$R_{VID} = 32.4 \text{ k}\Omega$	2.1	1.4
$R_{VID} = 25.5 \text{ k}\Omega$	2.0	1.1
$R_{VID} = 19.6 \text{ k}\Omega$	1.8	1.0
$R_{VID} = 15 \text{ k}\Omega$	1.5	0.9
$R_{VID} = 11.8 \text{ k}\Omega$	1.2	0.8

Any of the individual VID settings are available as internally fixed options. Contact an Analog Devices, Inc., sales representative for more information on generating new models.

UNDERVOLTAGE LOCKOUT (UVLO)

The undervoltage lockout circuitry monitors the input voltage level on the PVIN pin. If input voltage falls below 2.00 V (typical), the regulator turns off. After the input voltage rises above 2.06 V (typical), the soft start period is initiated, and the regulator is enabled when the EN pin is high.

ENABLE/DISABLE

The ADP5301 includes a separate enable pin (EN). A logic high in the EN pin starts the regulator. Due to the low quiescent current design, it is typical for the regulator to start switching after a delay of a few milliseconds from the EN pin being pulled high.

A logic low on the EN pin immediately disables the regulator and brings the regulator into extremely low current consumption.

CURRENT LIMIT

The buck regulator in the ADP5301 has protection circuitry that limits the direction and the amount of current to a certain level that flows through the high-side MOSFET and the low-side MOSFET in cycle-by-cycle mode. The positive current limit on the high-side MOSFET limits the amount of current that can flow from the input to the output. The negative current limit on the low-side MOSFET prevents the inductor current from reversing direction and flowing out of the load.

SHORT-CIRCUIT PROTECTION

The buck regulator in ADP5301 includes frequency foldback to prevent current runaway on a hard short. When the output voltage at the FB pin falls below 0.3 V typical, indicating the possibility of a hard short at the output, the switching frequency (in PWM mode) is reduced to one-fourth of the internal oscillator frequency. The reduction in the switching frequency allows more time for the inductor to discharge, preventing a runaway of output current.

SOFT START

The ADP5301 has an internal soft start function that ramps up the output voltage in a controlled manner upon startup, thereby limiting the inrush current. This feature prevents possible input voltage drops when a battery or a high impedance power source is connected to the input of the device. The default typical soft start time is 350 μ s for the regulator.

A different soft start time (2800 μ s) can be programmed for ADP5301 by the factory fuse.

STARTUP WITH A PRECHARGED OUTPUT

The buck regulator in the ADP5301 includes a precharged start-up feature to protect the low-side MOSFET from damage during startup. If the output voltage is precharged before the regulator turns on, the regulator prevents reverse inductor current—which discharges the output capacitor—until the internal soft start reference voltage exceeds the precharged voltage on the feedback pin.

100% DUTY CYCLE OPERATION

When the input voltage approaches the output voltage, the ADP5301 stops switching and enters 100% duty cycle operation. It connects the output via the inductor and the internal high-side power switch to the input. When the input voltage is charged again and the required duty cycle falls to 95% typical, the buck immediately restarts switching and regulation without allowing overshoot on the output voltage. In hysteresis mode, the ADP5301 draws an ultralow quiescent current of only 570 nA typical during 100% duty cycle operation.

ACTIVE DISCHARGE

The ADP5301 integrates an optional, factory programmable discharge switch from the switching node to ground. This switch turns on when its associated regulator is disabled, which helps discharge the output capacitor quickly. The typical value of the discharge switch is 290 Ω for the regulator.

By default, the discharge function is not enabled. The active discharge function can be enabled by the factory fuse.

VOUTOK FUNCTION

The ADP5301 includes an open-drain power-good output (VOUTOK pin) that is active high when the buck regulator is operating normally. By default, the VOUTOK pin monitors the output voltage. A logic high on the VOUTOK pin indicates that the regulated output voltage of the buck regulator is above 90% (typical) of its nominal output. When the regulated output voltage of the buck regulator falls below 87% (typical) of its nominal output for a delay time greater than approximately 10 μ s, the VOUTOK pin goes low.

THERMAL SHUTDOWN

If the ADP5301 junction temperature exceeds 142°C, the thermal shutdown circuit turns off the IC except for the internal linear regulator. Extreme junction temperatures can be the result of high current operation, poor circuit board design, or high ambient temperature. A 15°C hysteresis is included so that the ADP5301 does not return to operation after thermal shutdown until the junction temperature falls below 127°C. When the device exits thermal shutdown, a soft start is initiated for the buck regulator.

APPLICATIONS INFORMATION

This section describes the external components selection for the ADP5301. A typical application circuit is shown in Figure 38.

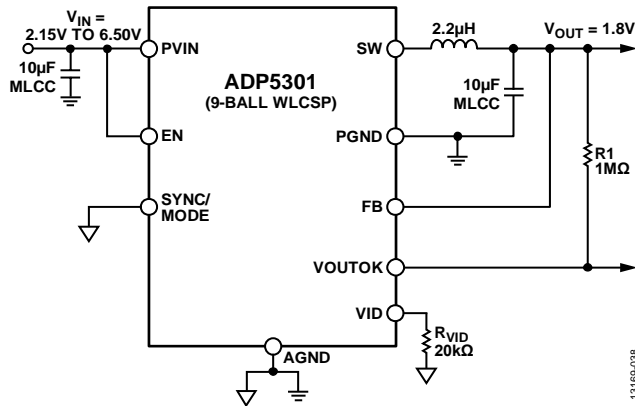

Figure 38. Typical Application Circuit

EXTERNAL COMPONENT SELECTION

The ADP5301 is optimized for operation with a 2.2 µH inductor and 10 µF output capacitors for various output voltages using the closed-loop compensation and adaptive slope compensation circuits. The selection of components depends on the efficiency, the load current transient, and other application requirements. The trade-offs among performance parameters, such as efficiency and transient response, are made by varying the choice of external components.

SELECTING THE INDUCTOR

The high switching frequency of the ADP5301 allows the use of small surface-mount power inductors. The dc resistance (DCR) value of the selected inductor affects efficiency. In addition, it is recommended to select a multilayer inductor rather than a magnetic iron inductor because the high switching frequency increases the core temperature rise and enlarges the core loss.

Table 6. Recommended Inductors

Vendor	Model	Inductance (µH)	Dimensions (mm)	DCR (mΩ)	Isat ¹ (A)
TDK	MLP2016V2R2MT0S1	2.2	2.0 × 1.6 × 0.85	280	1.0
Würth	74479889222	2.2	2.5 × 2.0 × 1.2	250	1.7
Coilcraft	LPS3314-222MR	2.2	3.3 × 3.3 × 1.3	100	1.5

¹ Isat is the dc current at which the inductance drops 30% (typical) from its value without current.

Table 7. Input and Output Capacitors

Vendor	Model	Capacitance (µF)	Size
Murata	GRM188D71A106MA73	10	0603
Murata	GRM21BR71A106KE51	10	0805
Murata	GRM31CR71A106KA01	10	1206

A minimum requirement of the dc current rating of the inductor is for it to be equal to the maximum load current plus half of the inductor current ripple (ΔI_L), as shown by the following equations:

$$\Delta I_L = V_{OUT} \left(1 - \frac{V_{OUT}}{V_{IN}} \right) \left(\frac{1}{L \times f_{SW}} \right)$$

$$I_{PK} = I_{LOAD(MAX)} + \left(\frac{\Delta I_L}{2} \right)$$

Use the inductor series from different vendors shown in Table 6.

OUTPUT CAPACITOR

Output capacitance is required to minimize the voltage overshoot, the voltage undershoot, and the ripple voltage present on the output. Capacitors with low equivalent series resistance (ESR) values produce the lowest output ripple. Furthermore, use capacitors such as X5R and X7R dielectric capacitors. Do not use Y5V and Z5U capacitors, which are unsuitable choices due to their large capacitance variation over temperature and their dc bias voltage changes. Because ESR is important, select the capacitor using the following equation:

$$ESR_{COUT} \leq \frac{V_{RIPPLE}}{\Delta I_L}$$

where:

ESR_{COUT} is the ESR of the chosen capacitor.

V_{RIPPLE} is the peak-to-peak output voltage ripple.

Increasing the output capacitor value has no effect on stability and may reduce output ripple and enhance load transient response. When choosing the output capacitor value, it is important to account for the loss of capacitance due to output voltage dc bias.

Use the capacitor series from different vendors shown in Table 7.

INPUT CAPACITOR

An input capacitor is required to reduce the input voltage ripple, input ripple current, and source impedance. Place the input capacitor as close as possible to the PVIN pin. A low ESR X7R or X5R capacitor is highly recommended to minimize the input voltage ripple. Use the following equation to determine the rms input current:

$$I_{RMS} \geq I_{LOAD(MAX)} \sqrt{\frac{V_{OUT}(V_{IN} - V_{OUT})}{V_{IN}}}$$

For most applications, a 10 μ F capacitor is sufficient. The input capacitor can be increased without any limit for better input voltage filtering.

EFFICIENCY

Efficiency is the ratio of output power to input power. The high efficiency of the ADP5301 has two distinct advantages. First, only a small amount of power is lost in the dc-to-dc converter package, which in turn reduces thermal constraints. Second, the high efficiency delivers the maximum output power for the given input power, thereby extending battery life in portable applications.

Power Switch Conduction Losses

Power switch dc conduction losses are caused by the flow of output current through the high-side P-channel power switch and the low-side N-channel synchronous rectifier, which have internal resistances ($R_{DS(ON)}$) associated with them. The amount of power loss is approximated by

$$P_{SW_COND} = (R_{DS(ON)H} \times D + R_{DS(ON)L} \times (1 - D)) \times I_{OUT}^2$$

where:

$$D = \frac{V_{OUT}}{V_{IN}}$$

The internal resistance of the power switches increases with temperature and with the input voltage decrease.

Inductor Losses

Inductor conduction losses are caused by the flow of current through the inductor, which has an internal DCR associated with it. Larger size inductors have smaller DCR, which can decrease inductor conduction losses. Inductor core losses relate to the magnetic permeability of the core material. Because the ADP5301 is a high switching frequency dc-to-dc regulator, shielded ferrite core material is recommended because of its low core losses and low electromagnetic interference (EMI).

To estimate the total amount of power lost in the inductor, use the following equation:

$$P_L = DCR \times I_{OUT}^2 + Core\ Losses$$

Driver Losses

Driver losses are associated with the current drawn by the driver to turn on and turn off the power devices at the switching frequency. Each time a power device gate is turned on and turned off, the driver transfers a charge from the input supply to the gate, and then from the gate to ground.

Estimate driver losses using the following equation:

$$P_{DRIVER} = (C_{GATE,H} + C_{GATE,L}) \times V_{IN}^2 \times f_{SW}$$

where:

$C_{GATE,H}$ is the gate capacitance of the internal high-side switch.

$C_{GATE,L}$ is the gate capacitance of the internal low-side switch.

f_{SW} is the switching frequency in PWM mode.

The typical values for the gate capacitances are 69 pF for $C_{GATE,H}$ and 31 pF for $C_{GATE,L}$.

Transition Losses

Transition losses occur because the P-channel switch cannot turn on or turn off instantaneously. In the middle of a switch node transition, the power switch provides all of the inductor current. The source to drain voltage of the power switch is half of the input voltage, resulting in power loss. Transition losses increase with both load current and input voltage and occur twice for each switching cycle.

Use the following equation to estimate transition losses:

$$P_{TRAN} = V_{IN}/2 \times I_{OUT} \times (t_R + t_F) \times f_{SW}$$

where:

t_R is the rise time of the SW node.

t_F is the fall time of the SW node.

The typical value for the rise and fall times, t_R and t_F , is 2 ns.

PRINTED CIRCUIT BOARD (PCB) LAYOUT RECOMMENDATIONS

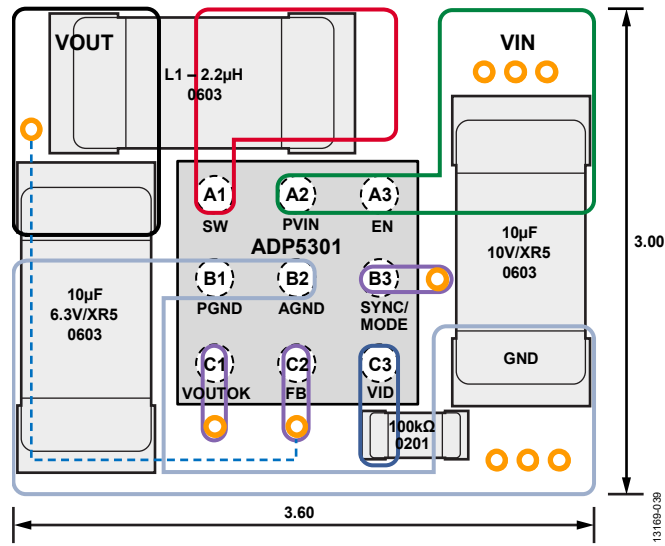

Figure 39. Typical PCB Layout

TYPICAL APPLICATION CIRCUITS

The ADP5301 can be used as a keep-alive, ultralow step-down power regulator to extend the battery life (see Figure 40) and as a battery-powered equipment or wireless sensor network controlled by a microcontroller or a processor (see Figure 41).

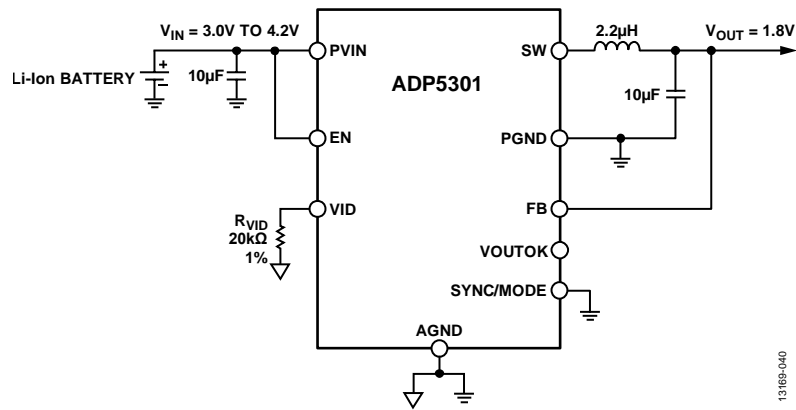

Figure 40. Typical ADP5301 Application with Li-Ion Battery

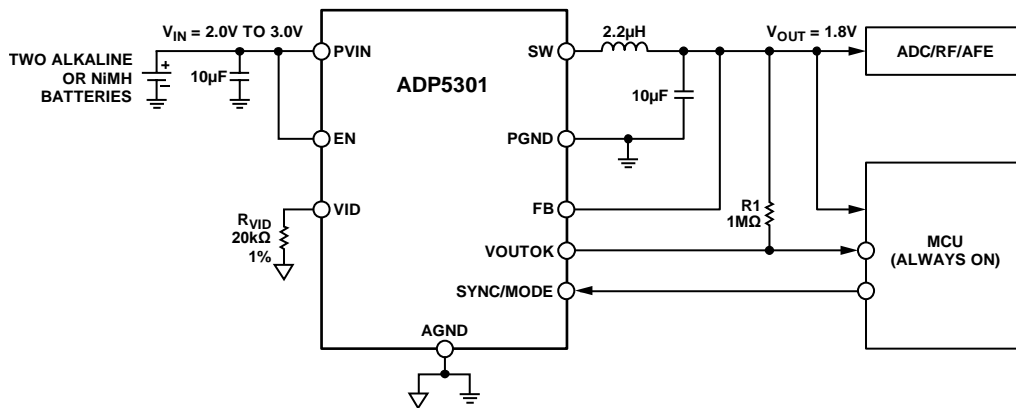

Figure 41. Typical ADP5301 Application with Two Alkaline/NiMH Batteries

FACTORY PROGRAMMABLE OPTIONS

To order a device with options other than the default options, contact your local Analog Devices sales or distribution representative.

Table 8. Output Voltage VID Setting Options

Option	Description
Option 0	VID resistor to set the output voltage as follows: 1.2 V, 1.5 V, 1.8 V, 2.0 V, 2.1 V, 2.2 V, 2.3 V, 2.4 V, 2.5 V, 2.6 V, 2.7 V, 2.8 V, 2.9 V, 3.0 V, 3.3 V, or 3.6 V (ADP5301ACBZ-1-R7 and ADP5301ACBZ-2-R7 default)
Option 1	VID resistor to set the output voltage as follows: 0.8 V, 0.9 V, 1.0 V, 1.1 V, 1.3 V, 1.4 V, 1.6 V, 1.7 V, 1.9 V, 3.1 V, 3.2 V, 3.4 V, 3.9 V, 4.2 V, 4.5 V, or 5.0 V (ADP5301ACBZ-3-R7 default)
Option 2	3.3 V fixed output voltage without VID setting: ADP5301ACBZ-4-R7

Table 9. Output Discharge Functionality Options

Option	Description
Option 0	Output discharge function disabled for buck regulator (ADP5301ACBZ-2-R7 and ADP5301ACBZ-4-R7 default)
Option 1	Output discharge function enabled for buck regulator (ADP5301ACBZ-1-R7 and ADP5301ACBZ-3-R7 default)

Table 10. Soft Start Time Options

Option	Description
Option 0	350 μ s (ADP5301ACBZ-1-R7 , ADP5301ACBZ-2-R7 , and ADP5301ACBZ-3-R7 default)
Option 1	2800 μ s (ADP5301ACBZ-4-R7 default)

OUTLINE DIMENSIONS

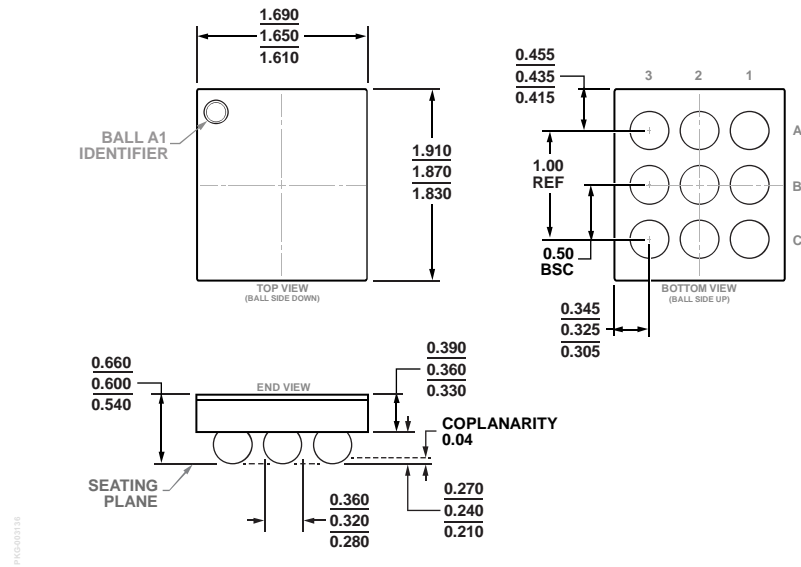

Figure 42. 9-Ball Wafer Level Chip Scale Package [WLCSP]
(CB-9-6)
Dimensions shown in millimeters

ORDERING GUIDE

Model ¹	Temperature Range	Package Description	Package Option
ADP5301ACBZ-1-R7	-40°C to +125°C	9-Ball Wafer Level Chip Scale Package [WLCSP]	CB-9-6
ADP5301ACBZ-2-R7	-40°C to +125°C	9-Ball Wafer Level Chip Scale Package [WLCSP]	CB-9-6
ADP5301ACBZ-3-R7	-40°C to +125°C	9-Ball Wafer Level Chip Scale Package [WLCSP]	CB-9-6
ADP5301ACBZ-4-R7	-40°C to +125°C	9-Ball Wafer Level Chip Scale Package [WLCSP]	CB-9-6
ADP5301-EVALZ		Evaluation Board	

¹ Z = RoHS Compliant Part.