

Power Inductors

Model HA72L-1040 series



Features:

- Operating Temperature Range -55°C to $+155^{\circ}\text{C}$
- Ambient Temperature, Maximum $+115^{\circ}\text{C}$
- Temperature Rise, 40°C
- RoHS Compliant
- AEC-Q200 Certified

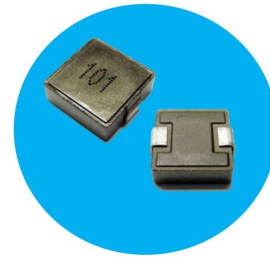

 All parts are Pb-free and comply with EU Directive 2011/65/EU (RoHS2)

Schematic

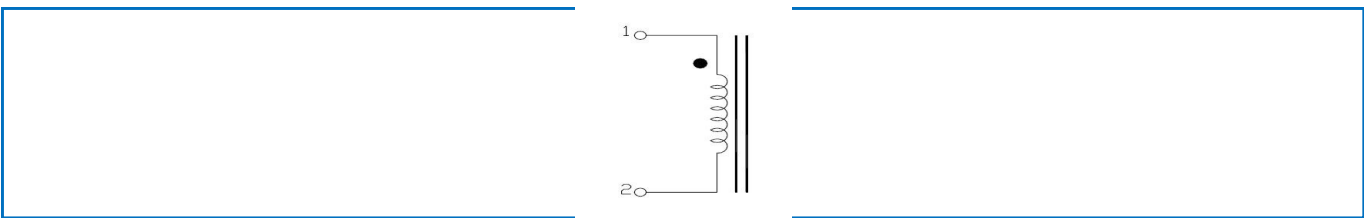

Specifications @ 25°C

Part Number	Inductance ($\mu\text{H} \pm 20\%$ @0A)	DCR (m Ω) Typ	DCR (m Ω) Max	I _{rms} (A)	I _{sat} (A)	Part Number	Inductance ($\mu\text{H} \pm 20\%$ @0A)	DCR (m Ω) Typ.	DCR (m Ω) Max	I _{rms} (A)	I _{sat} (A)
HA72L-1040R19LFTR	0.19	0.70	0.80	40.0	46.0	HA72L-10405R6LFTR	5.60	15.5	16.5	9.2	7.4
HA72L-1040R24LFTR	0.24	0.85	0.95	33.0	44.0	HA72L-10406R8LFTR	6.80	17.5	19.3	9.0	7.5
HA72L-1040R36LFTR	0.36	1.05	1.15	32.0	30.0	HA72L-10408R2LFTR	8.20	22.0	24.0	8.3	7.3
HA72L-1040R47LFTR	0.47	1.53	1.68	30.0	30.0	HA72L-1040100LFTR	10.0	27.80	30.50	7.5	7.1
HA72L-1040R56LFTR	0.56	1.6	1.8	32.0	22.0	HA72L-1040150LFTR	15.0	40.90	45.00	6.25	6.0
HA72L-1040R78LFTR	0.78	1.8	1.9	27.0	22.0	HA72L-1040220LFTR	22.0	60.40	66.00	5.0	4.5
HA72L-10401R0LFTR	1.00	2.3	2.5	25.0	20.0	HA72L-1040330LFTR	33.0	87.50	94.50	4.4	4.0
HA72L-10401R2LFTR	1.20	2.3	2.5	25.0	20.0	HA72L-1040470LFTR	47.0	132.0	145.0	4.0	3.0
HA72L-10401R8LFTR	1.80	4.5	5.0	17.0	16.0	HA72L-1040560LFTR	56.0	150.0	170.0	3.8	2.8
HA72L-10402R0LFTR	2.00	5.2	5.8	16.0	14.0	HA72L-1040680LFTR	68.0	175.0	200.0	3.5	2.6
HA72L-10403R3LFTR	3.30	8.2	9.0	12.0	14.0	HA72L-1040820LFTR	82.0	210.0	240.0	3.2	2.4
HA72L-10404R7LFTR	4.70	12.9	14.2	9.5	7.6	HA72L-1040101LFTR	100.0	249.0	270.0	3.0	2.25

- Notes: (1) I_{sat} is the saturation current at which inductance rolls off approximately 30% from its initial (zero DC)
 (2) I_{rms} is the approximate current at which $\Delta T = 40^{\circ}\text{C}$
 (3) Operating Temperature Range -55°C to $+155^{\circ}\text{C}$

General Note

TT Electronics reserves the right to make changes in product specification without notice or liability. All information is subject to TT Electronics' own data and is considered accurate at time of going to print.

TT Electronics | BI Technologies
 A-1445, Jalan Tanjung Api

25050 Kuantan Pahang Darul Makmur, Malaysia | Ph: +60 9 565 8888
www.ttelectronicsmagnetics.com/customer-service-enquiry

Electrical Characteristics @ 25°C

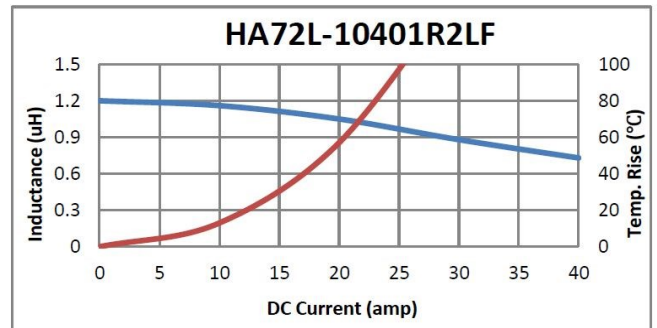
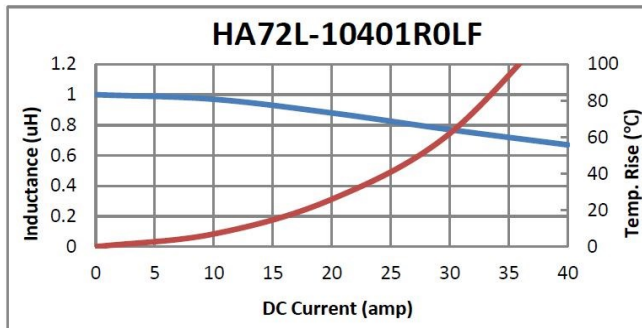
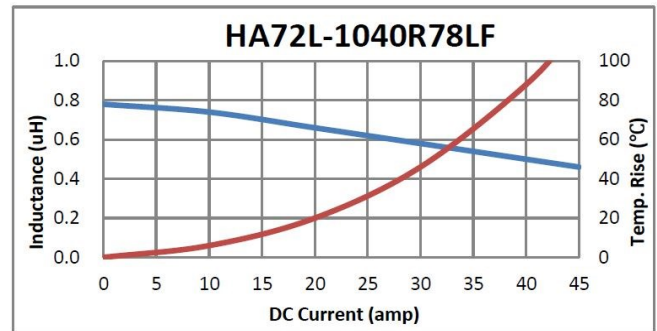
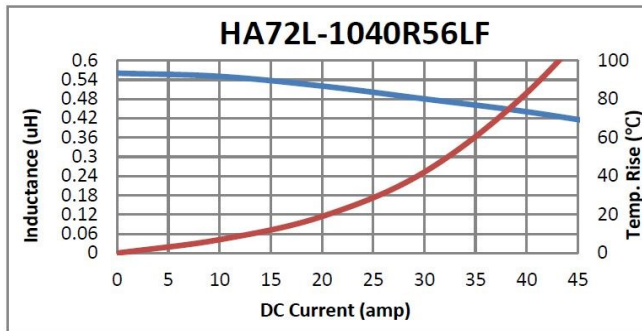
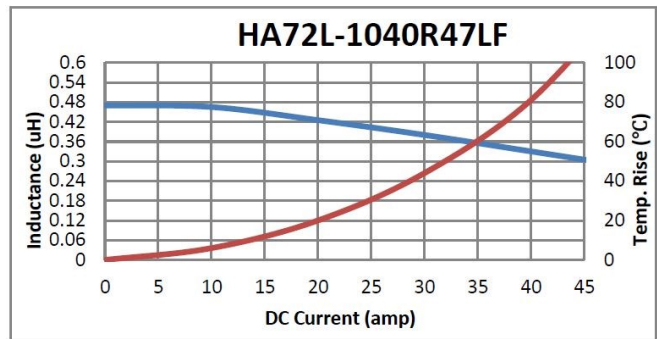
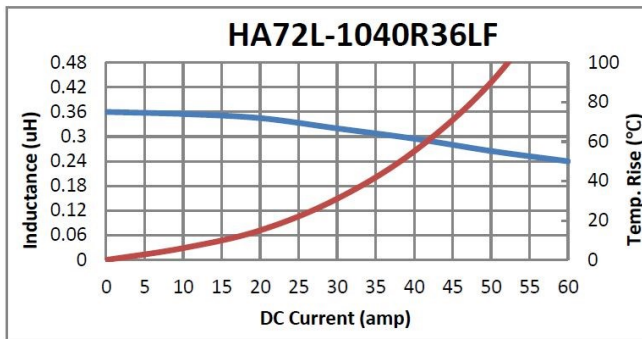
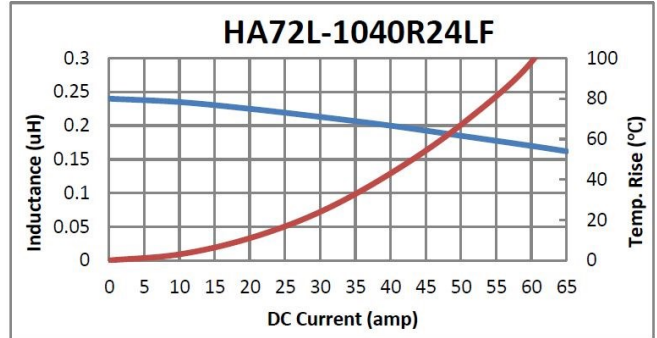
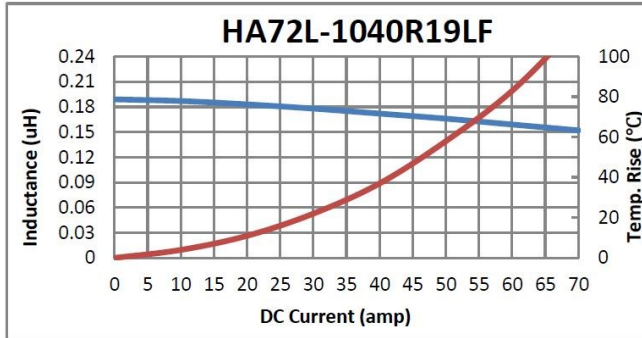

General Note
 TT Electronics reserves the right to make changes in product specification without notice or liability. All information is subject to TT Electronics' own data and is considered accurate at time of going to print.

TT Electronics | BI Technologies
 A-1445, Jalan Tanjung Api
 25050 Kuantan Pahang Darul Makmur, Malaysia | Ph: +60 9 565 8888
www.ttelectronicsmagnetics.com/customer-service-enquiry

Electrical Characteristics @ 25°C

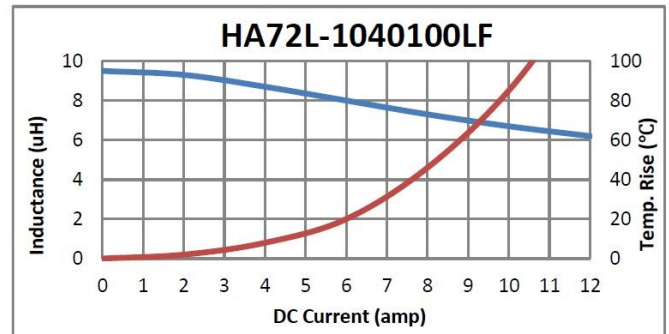
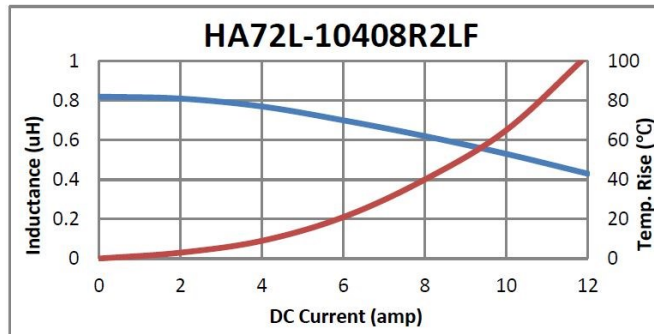
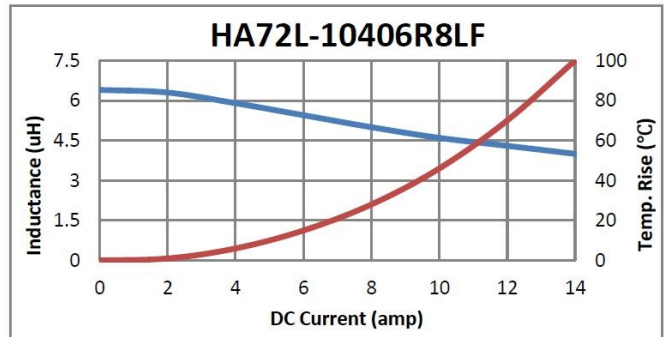
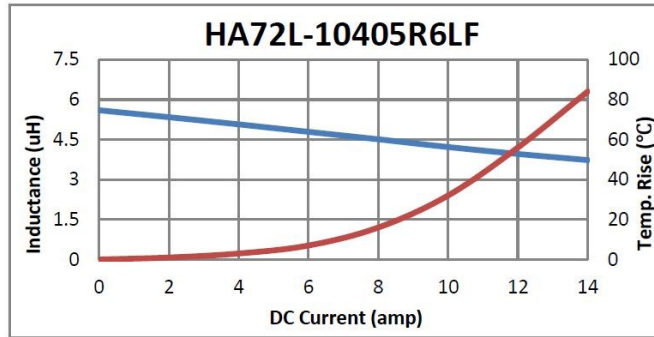
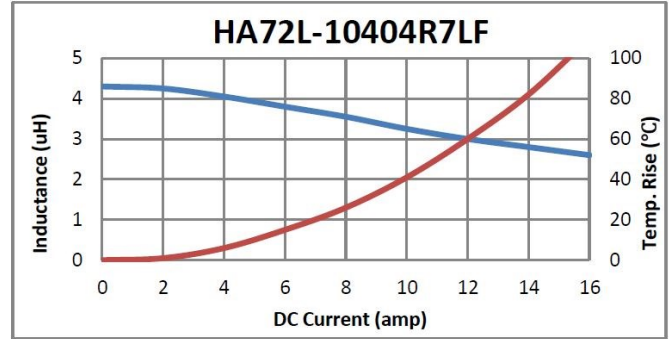
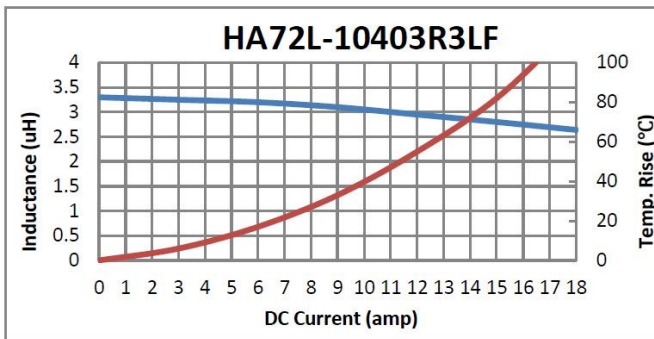
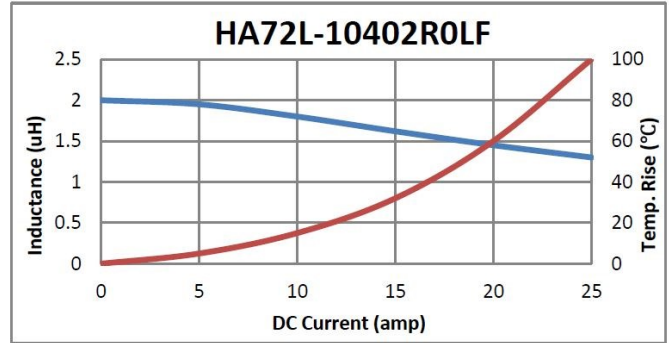
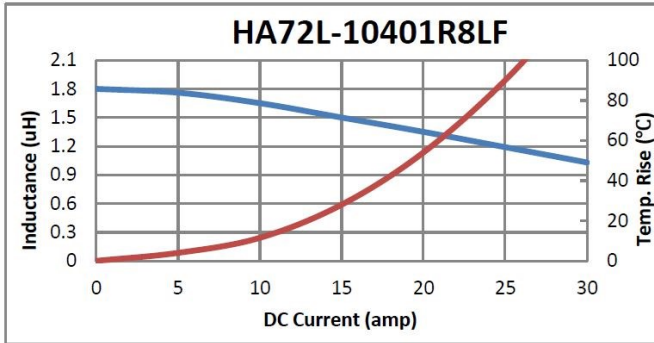

General Note
 TT Electronics reserves the right to make changes in product specification without notice or liability. All information is subject to TT Electronics' own data and is considered accurate at time of going to print.

TT Electronics | BI Technologies
 A-1445, Jalan Tanjung Api
 25050 Kuantan Pahang Darul Makmur, Malaysia | Ph: +60 9 565 8888
www.ttelectronicsmagnetics.com/customer-service-enquiry

Electrical Characteristics @ 25°C

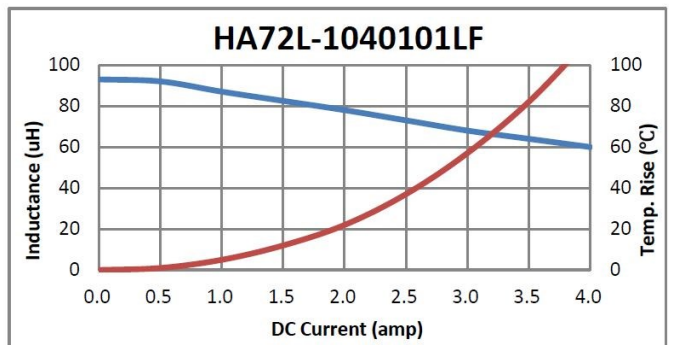
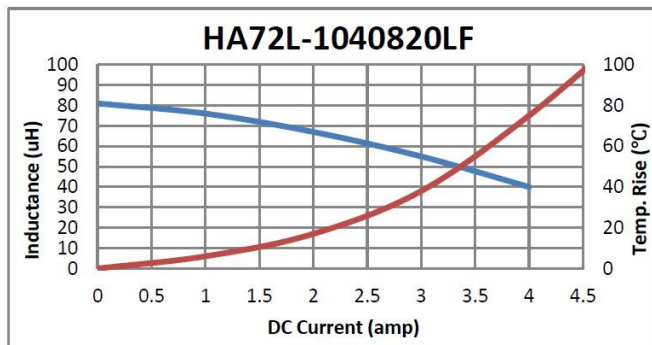
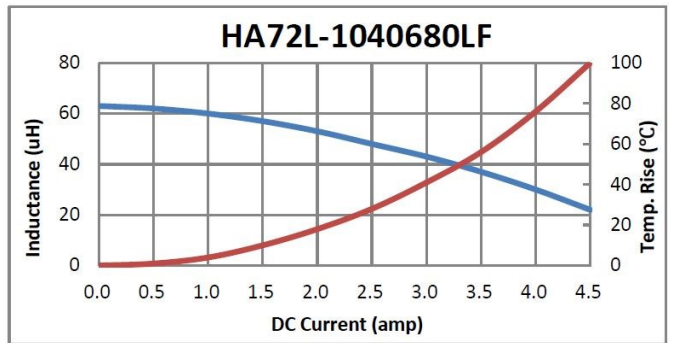
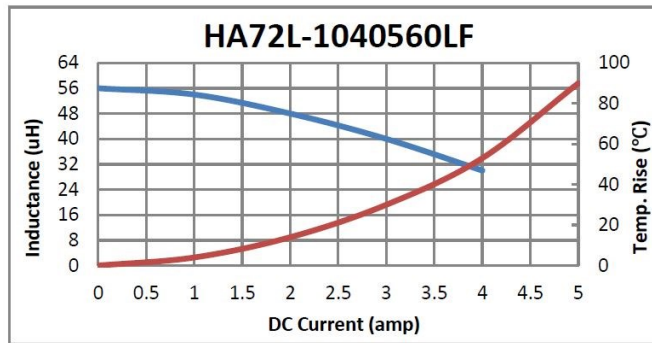
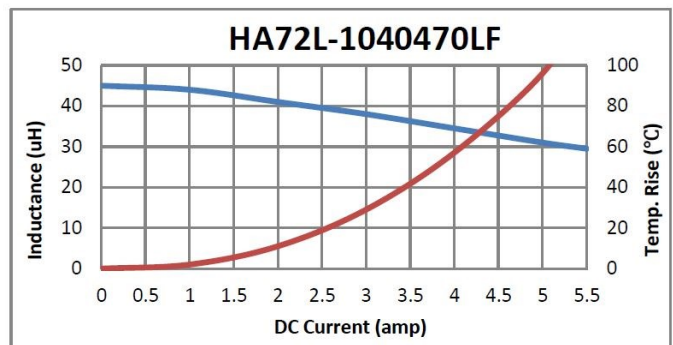
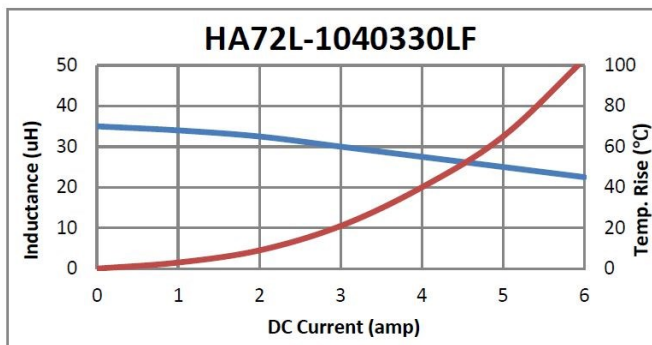
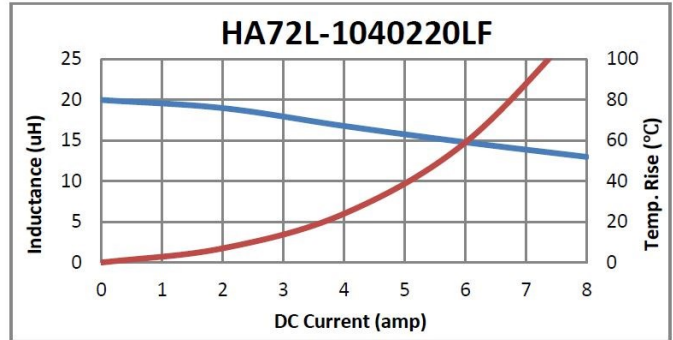
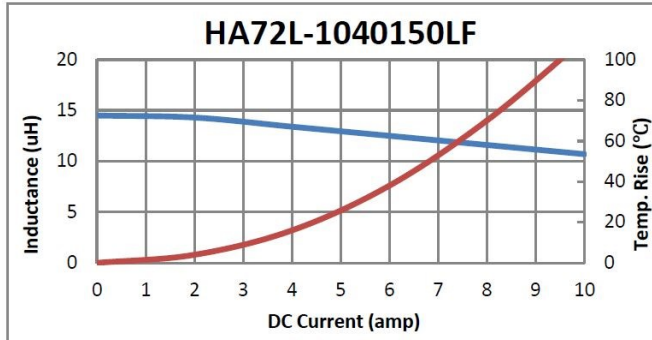

General Note
 TT Electronics reserves the right to make changes in product specification without notice or liability. All information is subject to TT Electronics' own data and is considered accurate at time of going to print.

TT Electronics | BI Technologies
 A-1445, Jalan Tanjung Api
 25050 Kuantan Pahang Darul Makmur, Malaysia | Ph: +60 9 565 8888
www.ttelectronicsmagnetics.com/customer-service-enquiry

Outline Dimensions (mm)

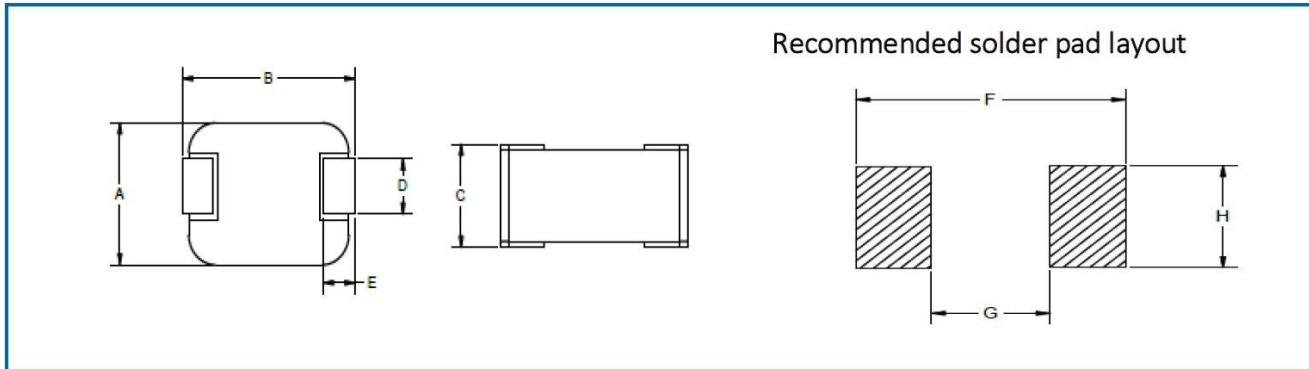

CASE SIZE	A(mm)	B(mm)	C(mm)	D(mm)	E(mm)	F(mm)	G(mm)	H(mm)
1040 series	10.0 ± 0.3	11.5 Max	4	2.8 ± 0.5	2.0 ± 0.5	13	6	4

Packaging

Standard:	Embossed Tape and Reel			
	Reel:	Diameter	All case size	= 13" (330mm)
		Capacity	Case size 1040	= 800 units

Ordering Information

HA72L – XXXX XXX LF TR

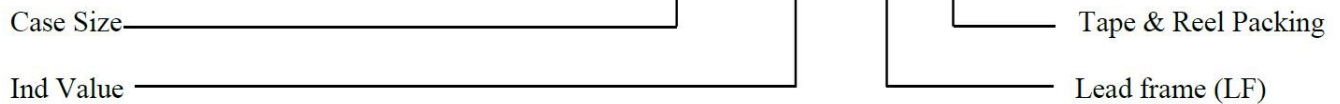

Mouser Electronics

Authorized Distributor

Click to View Pricing, Inventory, Delivery & Lifecycle Information:

TT Electronics:

[HA72L-1040101LFTR](#) [HA72L-1040R19LFTR](#) [HA72L-1040R36LFTR](#) [HA72L-1040100LFTR](#) [HA72L-10402R0LFTR](#)
[HA72L-1040220LFTR](#) [HA72L-1040560LFTR](#) [HA72L-10405R6LFTR](#) [HA72L-10406R8LFTR](#) [HA72L-10403R3LFTR](#)
[HA72L-1040820LFTR](#) [HA72L-1040470LFTR](#) [HA72L-10401R2LFTR](#) [HA72L-10401R8LFTR](#) [HA72L-10404R7LFTR](#)
[HA72L-1040150LFTR](#) [HA72L-1040R24LFTR](#) [HA72L-1040R47LFTR](#) [HA72L-10408R2LFTR](#) [HA72L-1040R56LFTR](#)
[HA72L-1040680LFTR](#) [HA72L-1040R78LFTR](#) [HA72L-1040330LFTR](#) [HA72L-10401R0LFTR](#)