

BC 161,6 UT HBUS BK - Mounting base housing



2278500

<https://www.phoenixcontact.com/us/products/2278500>

Please be informed that the data shown in this PDF document is generated from our online catalog. Please find the complete data in the user documentation. Our general terms of use for downloads are valid.



DIN rail housing for use in distribution boards in accordance with DIN 43880, Lower housing part with base latch, width: 161.6 mm, height: 89.7 mm, depth: 48.9 mm, color: black (similar RAL 9005), cross connection: DIN rail connector (optional), number of positions cross connector: 16

Your advantages

- Coordinated housing and connection system for faster device development
- Individual online configuration for diverse applications in building automation
- Variety of connection technology
- Can be mounted on the DIN rail or the wall
- With DIN-rail-mountable bus connector and power connector system as an option
- Tool-free mounting
- Available in overall widths from one to nine HP (17.8 mm ... 161.6 mm)
- Compliant with DIN EN 43880

Commercial data

Item number	2278500
Packing unit	10 pc
Minimum order quantity	10 pc
Sales key	AC10
Product key	ACHBAA
Catalog page	Page 700 (C-1-2013)
GTIN	4046356299497
Weight per piece (including packing)	90.11 g
Weight per piece (excluding packing)	82.58 g
Customs tariff number	84879090
Country of origin	DE

BC 161,6 UT HBUS BK - Mounting base housing



2278500

<https://www.phoenixcontact.com/us/products/2278500>

Technical data

Notes

General	Refer to the data sheet for the range in the download area.
---------	---

Product properties

Product type	Enclosure bottom part
Housing series	BC
Product family	BC UT HBUS
Max. number of positions	0)
Type	Lower housing part with base latch
Housing type	DIN rail housing for use in distribution boards in accordance with DIN 43880
Ventilation openings present	no

Dimensions

Dimensional drawing	
Width	161.6 mm
Height	89.7 mm
Depth	48.9 mm
Horizontal pitch	9 Div.

PCB design

PCB thickness	1.4 mm ... 1.8 mm
---------------	-------------------

Material specifications

Color (Housing)	black (RAL 9005)
Flammability rating according to UL 94	V0
CTI according to IEC 60112	< 400
Surface characteristics	untreated
Housing material	Polycarbonate

Environmental and real-life conditions

Power dissipation single housing for 20 °C

Ambient temperature	20 °C
Reduction factor	1
Mounting position	vertical

BC 161,6 UT HBUS BK - Mounting base housing



2278500

<https://www.phoenixcontact.com/us/products/2278500>

Power dissipation	16.95 W
-------------------	---------

Power dissipation single housing for 30 °C

Ambient temperature	30 °C
Reduction factor	0.84
Mounting position	vertical
Power dissipation	14.2 W

Power dissipation single housing for 40 °C

Ambient temperature	40 °C
Reduction factor	0.72
Mounting position	vertical
Power dissipation	12.2 W

Power dissipation single housing for 50 °C

Ambient temperature	50 °C
Reduction factor	0.6
Mounting position	vertical
Power dissipation	10.2 W

Power dissipation single housing for 60 °C

Ambient temperature	60 °C
Reduction factor	0.48
Mounting position	vertical
Power dissipation	8.1 W

Power dissipation single housing for 70 °C

Ambient temperature	70 °C
Reduction factor	0.38
Mounting position	vertical
Power dissipation	6.4 W

Vibration test

Specification	IEC 60068-2-6:2007-12
Frequency	10 - 150 - 10 Hz
Sweep speed	1 octave/min
Amplitude	0.15 mm (10 Hz ... 58.1 Hz)
Acceleration	2g (58.1 Hz ... 150 Hz)
Test duration per axis	2.5 h
Test directions	X-, Y- and Z-axis

Glow-wire test

Specification	IEC 60695-2-11:2014-02
Temperature	850 °C
Time of exposure	30 s

Mechanical strength / tumbling barrel

Specification	IEC 60068-2-31:2008-05
---------------	------------------------

BC 161,6 UT HBUS BK - Mounting base housing



2278500

<https://www.phoenixcontact.com/us/products/2278500>

Height of fall	50 cm
Frequency	50

Shocks

Specification	IEC 60068-2-27:2008-02
Pulse shape	Half-sine
Acceleration	15g
Shock duration	11 ms
Number of shocks per direction	3
Test directions	X-, Y- and Z-axis (pos. and neg.)

Degree of protection (IP code)

Specification	IEC 60529:1989-11 + AMD 1:1999-11 + AMD 2:2013-08
---------------	---

Ambient conditions

Max. IP code to attain	IP20
Ambient temperature (operation)	-40 °C ... 105 °C (depending on power dissipation)
Ambient temperature (storage/transport)	-40 °C ... 70 °C
Ambient temperature (assembly)	-5 °C ... 100 °C
Relative humidity (storage/transport)	95 %

PCB data

Number of PCB holders	9
Type of PCB mount	Latching
Thickness of the PCB	1.4 mm ... 1.8 mm

Mounting

Mounting type	DIN rail mounting/wall mounting
Mounting position	Vertical (horizontal DIN rail)

Packaging specifications

Type of packaging	packed in cardboard
Outer packaging type	Carton

BC 161,6 UT HBUS BK - Mounting base housing

2278500

<https://www.phoenixcontact.com/us/products/2278500>



Drawings

Dimensional drawing

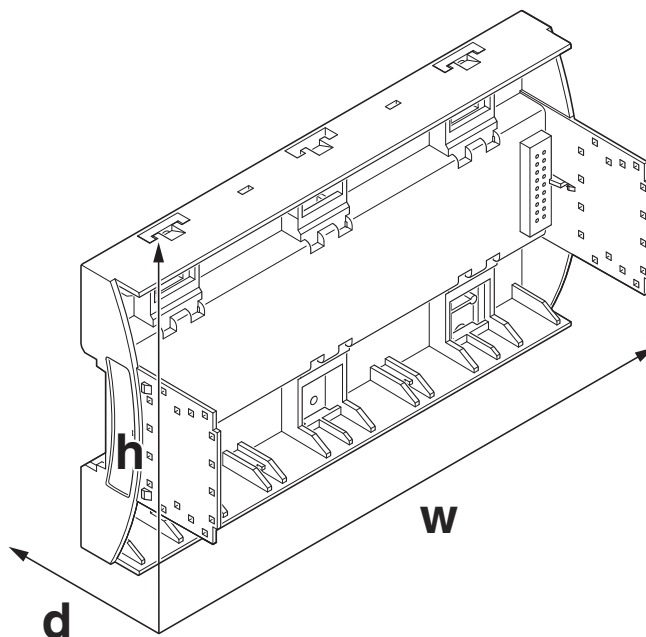

Schematic figure for illustrating the item dimensions. The figure is not of the desired product. For further details, refer to the product drawings in the "Downloads" tab.

BC 161,6 UT HBUS BK - Mounting base housing



2278500

<https://www.phoenixcontact.com/us/products/2278500>

Approvals

To download certificates, visit the product detail page: <https://www.phoenixcontact.com/us/products/2278500>



UL Recognized

Approval ID: FILE E 240868

BC 161,6 UT HBUS BK - Mounting base housing



2278500

<https://www.phoenixcontact.com/us/products/2278500>

Classifications

ECLASS

ECLASS-11.0	27182702
ECLASS-13.0	27190601

ETIM

ETIM 9.0	EC001031
----------	----------

UNSPSC

UNSPSC 21.0	31261500
-------------	----------

BC 161,6 UT HBUS BK - Mounting base housing



2278500

<https://www.phoenixcontact.com/us/products/2278500>

Environmental product compliance

China RoHS	Environmentally friendly use period: unlimited = EFUP-e
	No hazardous substances above threshold values

BC 161,6 UT HBUS BK - Mounting base housing



2278500

<https://www.phoenixcontact.com/us/products/2278500>

Mandatory accessories

BC 161,6 OT U11 KMGY - Upper housing part

2278513

<https://www.phoenixcontact.com/us/products/2278513>

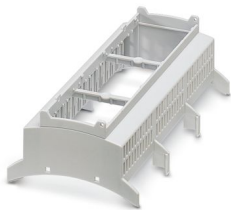

DIN rail housing for use in distribution boards in accordance with DIN 43880, Upper housing part (U11) with vents, Installation depth connection technology: 11.1 mm, width: 161.6 mm, height: 89.7 mm, depth: 54.85 mm, color: light grey (similar RAL 7035)

BC 161,6 OT U22 KMGY - Upper housing part

2278526

<https://www.phoenixcontact.com/us/products/2278526>



DIN rail housing for use in distribution boards in accordance with DIN 43880, Upper housing part (U22) with vents, Installation depth connection technology: 22.35 mm, width: 161.6 mm, height: 89.7 mm, depth: 54.85 mm, color: light grey (similar RAL 7035)

BC 161,6 UT HBUS BK - Mounting base housing



2278500

<https://www.phoenixcontact.com/us/products/2278500>

BC 161,6 OT U11 BK - Upper housing part

2202833

<https://www.phoenixcontact.com/us/products/2202833>



DIN rail housing for use in distribution boards in accordance with DIN 43880, Upper housing part (U11) with vents, Installation depth connection technology: 11.1 mm, width: 161.6 mm, height: 89.7 mm, depth: 54.85 mm, color: black (similar RAL 9005)

BC 161,6 OT U22 BK - Upper housing part

2201665

<https://www.phoenixcontact.com/us/products/2201665>



DIN rail housing for use in distribution boards in accordance with DIN 43880, Upper housing part (U22) with vents, Installation depth connection technology: 22.35 mm, width: 161.6 mm, height: 89.7 mm, depth: 54.85 mm, color: black (similar RAL 9005)

BC 161,6 UT HBUS BK - Mounting base housing

2278500

<https://www.phoenixcontact.com/us/products/2278500>



BC 161,6 OT 111112 BK - Upper housing part

2201977

<https://www.phoenixcontact.com/us/products/2201977>



DIN rail housing for use in distribution boards in accordance with DIN 43880, modular upper housing part, width: 161.6 mm, height: 89.7 mm, depth: 54.85 mm, color: black (similar RAL 9005)

BC 161,6 OT 222121 BK - Upper housing part

1046793

<https://www.phoenixcontact.com/us/products/1046793>



DIN rail housing for use in distribution boards in accordance with DIN 43880, modular upper housing part, width: 161.6 mm, height: 89.7 mm, depth: 54.85 mm, color: black (similar RAL 9005)

BC 161,6 UT HBUS BK - Mounting base housing

2278500

<https://www.phoenixcontact.com/us/products/2278500>



BC 161,6 OT 111122 KMGY - Upper housing part

2201919

<https://www.phoenixcontact.com/us/products/2201919>

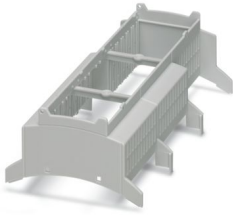

DIN rail housing for use in distribution boards in accordance with DIN 43880, modular upper housing part, width: 161.6 mm, height: 89.7 mm, depth: 54.85 mm, color: light grey (similar RAL 7035)

BC 161,6 OT 012122 KMGY - Upper housing part

2203722

<https://www.phoenixcontact.com/us/products/2203722>

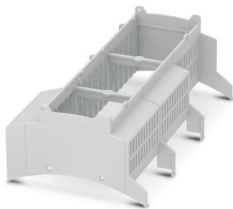

DIN rail housing for use in distribution boards in accordance with DIN 43880, modular upper housing part, width: 161.6 mm, height: 89.7 mm, depth: 54.85 mm, color: light grey (similar RAL 7035)

BC 161,6 UT HBUS BK - Mounting base housing



2278500

<https://www.phoenixcontact.com/us/products/2278500>

BC 161,6 OT 000020 KMGY - Upper housing part

2201450

<https://www.phoenixcontact.com/us/products/2201450>

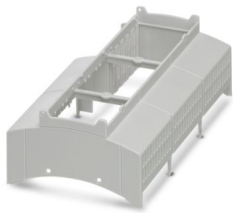

DIN rail housing for use in distribution boards in accordance with DIN 43880, modular upper housing part, width: 161.6 mm, height: 89.7 mm, depth: 54.85 mm, color: light grey (similar RAL 7035)

BC 161,6 OT 110021 KMGY - Upper housing part

1208340

<https://www.phoenixcontact.com/us/products/1208340>

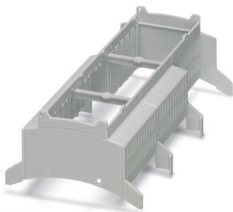

DIN rail housing for use in distribution boards in accordance with DIN 43880, modular upper housing part, width: 161.6 mm, height: 89.7 mm, depth: 54.85 mm, color: light grey (similar RAL 7035)

BC 161,6 UT HBUS BK - Mounting base housing



2278500

<https://www.phoenixcontact.com/us/products/2278500>

BC 161,6 OT 001101 KMGY - Upper housing part

2202284

<https://www.phoenixcontact.com/us/products/2202284>

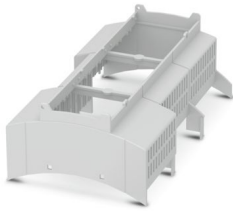

DIN rail housing for use in distribution boards in accordance with DIN 43880, modular upper housing part, width: 161.6 mm, height: 89.7 mm, depth: 54.85 mm, color: light grey (similar RAL 7035)

BC 161,6 OT 111112 KMGY - Upper housing part

2202638

<https://www.phoenixcontact.com/us/products/2202638>

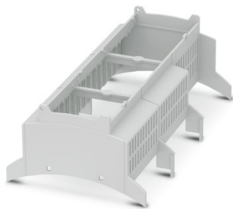

DIN rail housing for use in distribution boards in accordance with DIN 43880, modular upper housing part, width: 161.6 mm, height: 89.7 mm, depth: 54.85 mm, color: light grey (similar RAL 7035)

BC 161,6 UT HBUS BK - Mounting base housing



2278500

<https://www.phoenixcontact.com/us/products/2278500>

BC 161,6 OT 112111 KMGY - Upper housing part

1255434

<https://www.phoenixcontact.com/us/products/1255434>

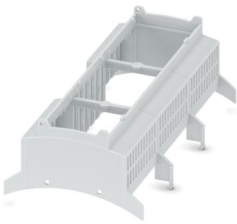

DIN rail housing for use in distribution boards in accordance with DIN 43880, modular upper housing part, width: 161.6 mm, height: 89.7 mm, depth: 54.85 mm, color: light grey (similar RAL 7035)

BC 161,6 OT 000022 KMGY - Upper housing part

2201454

<https://www.phoenixcontact.com/us/products/2201454>

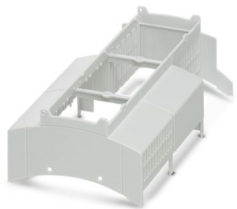

DIN rail housing for use in distribution boards in accordance with DIN 43880, modular upper housing part, width: 161.6 mm, height: 89.7 mm, depth: 54.85 mm, color: light grey (similar RAL 7035)

BC 161,6 UT HBUS BK - Mounting base housing

2278500

<https://www.phoenixcontact.com/us/products/2278500>



BC 161,6 OT 100202 KMGY - Upper housing part

2201976

<https://www.phoenixcontact.com/us/products/2201976>

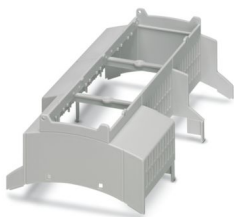

DIN rail housing for use in distribution boards in accordance with DIN 43880, modular upper housing part, width: 161.6 mm, height: 89.7 mm, depth: 54.85 mm, color: light grey (similar RAL 7035)

BC 161,6 OT 111121 KMGY - Upper housing part

2201982

<https://www.phoenixcontact.com/us/products/2201982>

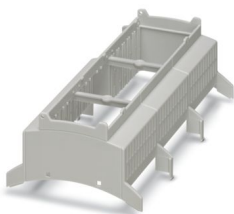

DIN rail housing for use in distribution boards in accordance with DIN 43880, modular upper housing part, width: 161.6 mm, height: 89.7 mm, depth: 54.85 mm, color: light grey (similar RAL 7035)

BC 161,6 UT HBUS BK - Mounting base housing



2278500

<https://www.phoenixcontact.com/us/products/2278500>

BC 161,6 OT 111101 KMGY - Upper housing part

2203095

<https://www.phoenixcontact.com/us/products/2203095>

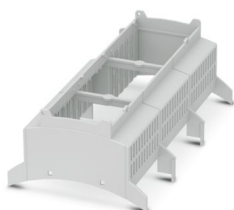

DIN rail housing for use in distribution boards in accordance with DIN 43880, modular upper housing part, width: 161.6 mm, height: 89.7 mm, depth: 54.85 mm, color: light grey (similar RAL 7035)

BC 161,6 OT 212121 KMGY - Upper housing part

2201869

<https://www.phoenixcontact.com/us/products/2201869>

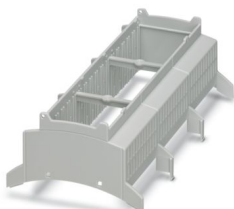

DIN rail housing for use in distribution boards in accordance with DIN 43880, modular upper housing part, width: 161.6 mm, height: 89.7 mm, depth: 54.85 mm, color: light grey (similar RAL 7035)

BC 161,6 UT HBUS BK - Mounting base housing



2278500

<https://www.phoenixcontact.com/us/products/2278500>

BC 161,6 OT 112122 KMGY - Upper housing part

2201881

<https://www.phoenixcontact.com/us/products/2201881>

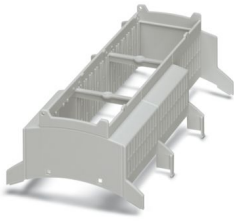

DIN rail housing for use in distribution boards in accordance with DIN 43880, modular upper housing part, width: 161.6 mm, height: 89.7 mm, depth: 54.85 mm, color: light grey (similar RAL 7035)

BC 161,6 OT 210021 KMGY - Upper housing part

2201984

<https://www.phoenixcontact.com/us/products/2201984>

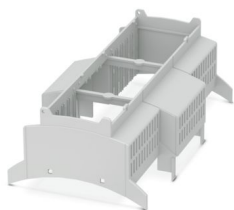

DIN rail housing for use in distribution boards in accordance with DIN 43880, modular upper housing part, width: 161.6 mm, height: 89.7 mm, depth: 54.85 mm, color: light grey (similar RAL 7035)

BC 161,6 UT HBUS BK - Mounting base housing

2278500

<https://www.phoenixcontact.com/us/products/2278500>



BC 161,6 OT U11 BK VPE80 - Upper housing part

1006944

<https://www.phoenixcontact.com/us/products/1006944>



DIN rail housing for use in distribution boards in accordance with DIN 43880, Upper housing part (U11) with vents, Installation depth connection technology: 11.1 mm, width: 161.6 mm, height: 89.7 mm, depth: 54.85 mm, color: black (similar RAL 9005)

BC 161,6 OT 212122 KMGY VPE80 - Upper housing part

1015337

<https://www.phoenixcontact.com/us/products/1015337>

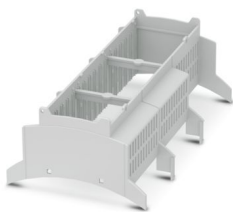

DIN rail housing for use in distribution boards in accordance with DIN 43880, modular upper housing part, width: 161.6 mm, height: 89.7 mm, depth: 54.85 mm, color: light grey (similar RAL 7035)

BC 161,6 UT HBUS BK - Mounting base housing

2278500

<https://www.phoenixcontact.com/us/products/2278500>



BC 161,6 OT 0C20C20C2 KMGY - Upper housing part

1218565

<https://www.phoenixcontact.com/us/products/1218565>



DIN rail housing for use in distribution boards in accordance with DIN 43880, modular upper housing part, width: 161.6 mm, height: 89.7 mm, depth: 54.85 mm, color: light grey (similar RAL 7035)

BC 161,6 OT 002000 KMGY - Upper housing part

2201451

<https://www.phoenixcontact.com/us/products/2201451>

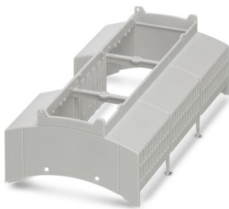

DIN rail housing for use in distribution boards in accordance with DIN 43880, modular upper housing part, width: 161.6 mm, height: 89.7 mm, depth: 54.85 mm, color: light grey (similar RAL 7035)

BC 161,6 UT HBUS BK - Mounting base housing

2278500

<https://www.phoenixcontact.com/us/products/2278500>



BC 161,6 OT 0C20C20C2 WH - Upper housing part

1252986

<https://www.phoenixcontact.com/us/products/1252986>



DIN rail housing for use in distribution boards in accordance with DIN 43880, modular upper housing part, width: 161.6 mm, height: 89.7 mm, depth: 54.85 mm, color: traffic white (similar RAL 9016)

BC 161,6 OT 000C0C22 KMGY - Upper housing part

2201678

<https://www.phoenixcontact.com/us/products/2201678>

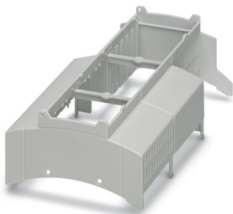

DIN rail housing for use in distribution boards in accordance with DIN 43880, modular upper housing part, width: 161.6 mm, height: 89.7 mm, depth: 54.85 mm, color: light grey (similar RAL 7035)

BC 161,6 UT HBUS BK - Mounting base housing

2278500

<https://www.phoenixcontact.com/us/products/2278500>



BC 161,6 OT 121222 KMGY MOQ100 - Upper housing part

2202355

<https://www.phoenixcontact.com/us/products/2202355>

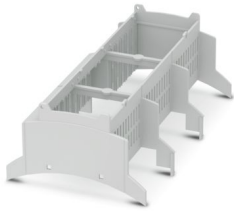

DIN rail housing for use in distribution boards in accordance with DIN 43880, modular upper housing part, width: 161.6 mm, height: 89.7 mm, depth: 54.85 mm, color: light grey (similar RAL 7035)

BC 161,6 OT 110212 KMGY MOQ100 - Upper housing part

1153038

<https://www.phoenixcontact.com/us/products/1153038>

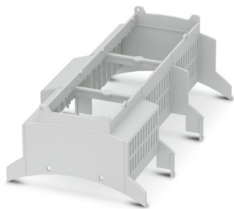

DIN rail housing for use in distribution boards in accordance with DIN 43880, modular upper housing part, width: 161.6 mm, height: 89.7 mm, depth: 54.85 mm, color: light grey (similar RAL 7035)

BC 161,6 UT HBUS BK - Mounting base housing



2278500

<https://www.phoenixcontact.com/us/products/2278500>

BC 161,6 OT 121222 BK VPE80 - Upper housing part

1059320

<https://www.phoenixcontact.com/us/products/1059320>



DIN rail housing for use in distribution boards in accordance with DIN 43880, modular upper housing part, width: 161.6 mm, height: 89.7 mm, depth: 54.85 mm, color: black (similar RAL 9005)

BC 161,6 OT 102222 KMGY MOQ100 - Upper housing part

2202202

<https://www.phoenixcontact.com/us/products/2202202>

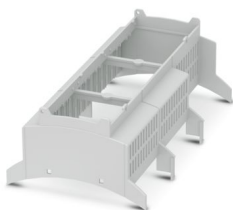

DIN rail housing for use in distribution boards in accordance with DIN 43880, modular upper housing part, width: 161.6 mm, height: 89.7 mm, depth: 54.85 mm, color: light grey (similar RAL 7035)

BC 161,6 UT HBUS BK - Mounting base housing



2278500

<https://www.phoenixcontact.com/us/products/2278500>

BC 161,6 OT 001112 KMGY MOQ100 - Upper housing part

2202287

<https://www.phoenixcontact.com/us/products/2202287>

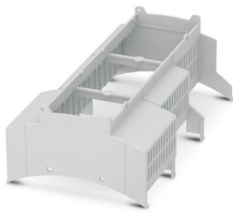

DIN rail housing for use in distribution boards in accordance with DIN 43880, modular upper housing part, width: 161.6 mm, height: 89.7 mm, depth: 54.85 mm, color: light grey (similar RAL 7035)

BC 161,6 OT 221111 KMGY MOQ100 - Upper housing part

2202300

<https://www.phoenixcontact.com/us/products/2202300>

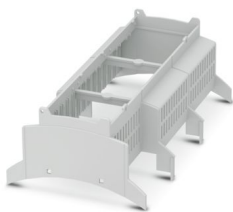

DIN rail housing for use in distribution boards in accordance with DIN 43880, modular upper housing part, width: 161.6 mm, height: 89.7 mm, depth: 54.85 mm, color: light grey (similar RAL 7035)

BC 161,6 UT HBUS BK - Mounting base housing

2278500

<https://www.phoenixcontact.com/us/products/2278500>



BC 161,6 OT 110202 KMGY VPE80 - Upper housing part

1080949

<https://www.phoenixcontact.com/us/products/1080949>

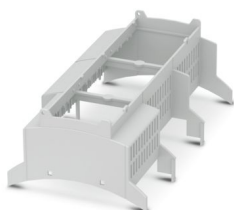

DIN rail housing for use in distribution boards in accordance with DIN 43880, modular upper housing part, width: 161.6 mm, height: 89.7 mm, depth: 54.85 mm, color: light grey (similar RAL 7035)

BC 161,6 OT 101111 KMGY MOQ100 - Upper housing part

2202201

<https://www.phoenixcontact.com/us/products/2202201>

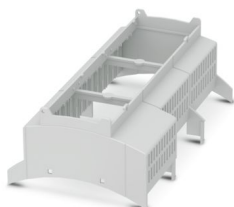

DIN rail housing for use in distribution boards in accordance with DIN 43880, modular upper housing part, width: 161.6 mm, height: 89.7 mm, depth: 54.85 mm, color: light grey (similar RAL 7035)

BC 161,6 UT HBUS BK - Mounting base housing

2278500

<https://www.phoenixcontact.com/us/products/2278500>



BC 161,6 OT 020001 KMGY MOQ100 - Upper housing part

2202224

<https://www.phoenixcontact.com/us/products/2202224>

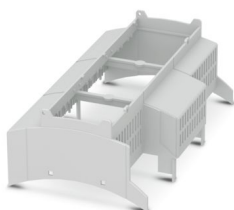

DIN rail housing for use in distribution boards in accordance with DIN 43880, modular upper housing part, width: 161.6 mm, height: 89.7 mm, depth: 54.85 mm, color: light grey (similar RAL 7035)

BC 161,6 OT 000C020 KMGYMOQ100 - Upper housing part

2202372

<https://www.phoenixcontact.com/us/products/2202372>

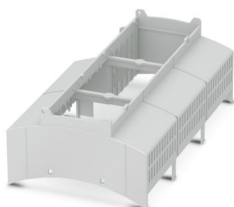

DIN rail housing for use in distribution boards in accordance with DIN 43880, modular upper housing part, width: 161.6 mm, height: 89.7 mm, depth: 54.85 mm, color: light grey (similar RAL 7035)

BC 161,6 UT HBUS BK - Mounting base housing

2278500

<https://www.phoenixcontact.com/us/products/2278500>



BC 161,6 OT 202220 KMGY VPE80 - Upper housing part

1074661

<https://www.phoenixcontact.com/us/products/1074661>

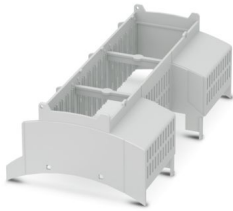

DIN rail housing for use in distribution boards in accordance with DIN 43880, modular upper housing part, width: 161.6 mm, height: 89.7 mm, depth: 54.85 mm, color: light grey (similar RAL 7035)

BC 161,6 OT 101100 KMGY VPE80 - Upper housing part

2202324

<https://www.phoenixcontact.com/us/products/2202324>

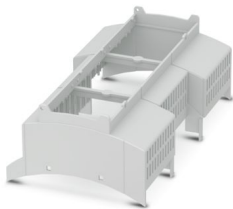

DIN rail housing for use in distribution boards in accordance with DIN 43880, modular upper housing part, width: 161.6 mm, height: 89.7 mm, depth: 54.85 mm, color: light grey (similar RAL 7035)

BC 161,6 UT HBUS BK - Mounting base housing

2278500

<https://www.phoenixcontact.com/us/products/2278500>



BC 161,6 OT 220222 KMGY MOQ100 - Upper housing part

1126202

<https://www.phoenixcontact.com/us/products/1126202>

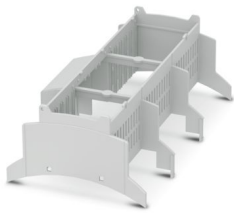

DIN rail housing for use in distribution boards in accordance with DIN 43880, modular upper housing part, width: 161.6 mm, height: 89.7 mm, depth: 54.85 mm, color: light grey (similar RAL 7035)

BC 161,6 OT 0C0C0C0C22 KMGY - Upper housing part

2201455

<https://www.phoenixcontact.com/us/products/2201455>

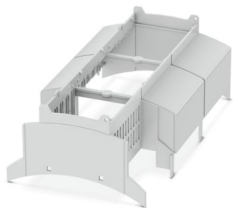

DIN rail housing for use in distribution boards in accordance with DIN 43880, modular upper housing part, width: 161.6 mm, height: 89.7 mm, depth: 54.85 mm, color: light grey (similar RAL 7035)

BC 161,6 UT HBUS BK - Mounting base housing

2278500

<https://www.phoenixcontact.com/us/products/2278500>



BC 161,6 OT 000000 KMGY MOQ100 - Upper housing part

2202926

<https://www.phoenixcontact.com/us/products/2202926>



DIN rail housing for use in distribution boards in accordance with DIN 43880, modular upper housing part, width: 161.6 mm, height: 89.7 mm, depth: 54.85 mm, color: light grey (similar RAL 7035)

BC 161,6 OT 112122 KMGY MOQ100 - Upper housing part

2202326

<https://www.phoenixcontact.com/us/products/2202326>

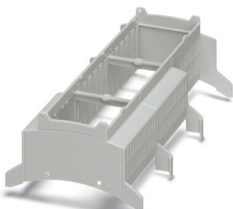

DIN rail housing for use in distribution boards in accordance with DIN 43880, modular upper housing part, width: 161.6 mm, height: 89.7 mm, depth: 54.85 mm, color: light grey (similar RAL 7035)

BC 161,6 UT HBUS BK - Mounting base housing



2278500

<https://www.phoenixcontact.com/us/products/2278500>

BC 161,6 OT 1C1C2C2C1C1C KMGY - Upper housing part

1096568

<https://www.phoenixcontact.com/us/products/1096568>

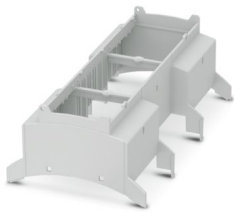

DIN rail housing for use in distribution boards in accordance with DIN 43880, modular upper housing part, width: 161.6 mm, height: 89.7 mm, depth: 54.85 mm, color: light grey (similar RAL 7035)

BC 161,6 OT 120202 KMGY MOQ100 - Upper housing part

1087950

<https://www.phoenixcontact.com/us/products/1087950>

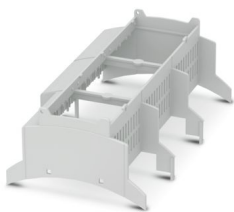

DIN rail housing for use in distribution boards in accordance with DIN 43880, modular upper housing part, width: 161.6 mm, height: 89.7 mm, depth: 54.85 mm, color: light grey (similar RAL 7035)

Accessories

BC 161,6 UT HBUS BK - Mounting base housing



2278500

<https://www.phoenixcontact.com/us/products/2278500>

FUSSRIEGEL 14,4 L30 SPERR OG - Base latch

2896998

<https://www.phoenixcontact.com/us/products/2896998>



DIN rail housing for use in distribution boards in accordance with DIN 43880, Base latch, width: 14.4 mm, height: 29.8 mm, depth: 5.9 mm, color: orange (similar RAL 2003)

HBUS 161,6-16P-1S BK - DIN rail bus connectors

2278555

<https://www.phoenixcontact.com/us/products/2278555>



DIN rail connector, color: black, nominal current: 3 A (Total current of 25 A max.), rated voltage (III/2): 30 V, number of positions: 16, pitch: 2.54 mm, mounting: DIN rail mounting, locking: without

BC 161,6 UT HBUS BK - Mounting base housing



2278500

<https://www.phoenixcontact.com/us/products/2278500>

PSTD 0,65X0,65/9-2,54 - Pin strip

2200700

<https://www.phoenixcontact.com/us/products/2200700>



Pin strip, color: black, contact connection type: Pin, number of potentials: 18, number of rows: 2, number of positions: 18, number of connections: 18, product range: PSTD 0,65X0,65/...-V, pitch: 2.54 mm, mounting: THR soldering, pin layout: Linear pinning, solder pin [P]: 2.5 mm, locking: without, type of packaging: packed in cardboard

HBUS8 161,6-8P-1S BK - DIN rail bus connectors

1249066

<https://www.phoenixcontact.com/us/products/1249066>



DIN rail connector, color: black, nominal current: 3 A (per contact), rated voltage (III/2): 100 V, number of positions: 8, pitch: 2.54 mm, mounting: DIN rail mounting, locking: without

Phoenix Contact 2024 © - all rights reserved
<https://www.phoenixcontact.com>

Phoenix Contact USA
586 Fulling Mill Road
Middletown, PA 17057, United States
(+717) 944-1300
info@phoenixcon.com