

MAX4364/MAX4365

1.4W and 1W, Ultra-Small, Audio Power Amplifiers with Shutdown

General Description

The MAX4364/MAX4365 are bridged audio power amplifiers intended for portable audio devices with internal speakers. The MAX4364 is capable of delivering 1.4W from a single 5V supply and 500mW from a single 3V supply into an 8Ω load. The MAX4365 is capable of delivering 1W from a single 5V supply and 450mW from a single 3V supply into an 8Ω load. The MAX4364/MAX4365 feature 0.04% THD+N at 1kHz, 68dB PSRR at 217Hz, and only 10nA of supply current in shutdown mode.

The MAX4364/MAX4365 bridged outputs eliminate the need for output-coupling capacitors, minimizing external component count. The MAX4364/MAX4365 also include internal DC bias generation, clickless operation, short-circuit and thermal-overload protection. Both devices are unity-gain stable, with the gain set by two external resistors.

The MAX4364 is available in a small 8-pin SO package. The MAX4365 is available in tiny 8-pin TDFN (3mm x 3mm x 0.8mm) and μMAX® packages.

Applications

- Cellular Phones
- PDAs
- Two-Way Radios
- General-Purpose Audio

Features

- 1.4W into 8Ω Load (MAX4364)
- 1W into 8Ω Load (MAX4365)
- 0.04% THD+N at 1kHz
- 68dB PSRR at 217Hz
- 2.7V to 5.5V Single-Supply Operation
- 5mA Supply Current
- Low-Power, 10nA Shutdown Mode
- Pin Compatible with the LM4861/LM4862/LM4864 (MAX4364)
- Clickless Power-Up and Shutdown
- Thermal-Overload and Short-Circuit Protection
- Available in TDFN, μMAX, and SO Packages

Ordering Information

PART	TEMP RANGE	PIN-PACKAGE	TOP MARK
MAX4364ESA/V+T	-40°C to +85°C	8 SO	—
MAX4365EUA+	-40°C to +85°C	8 μMAX	—
MAX4365ETA+	-40°C to +85°C	8 TDFN-EP*	ACD

*EP = Exposed pad.

+Denotes a lead(Pb)-free/RoHS-compliant package.

/V denotes an automotive qualified part.

T = Tape and reel.

Pin Configurations appear at end of data sheet.

Typical Application Circuit/Functional Diagram

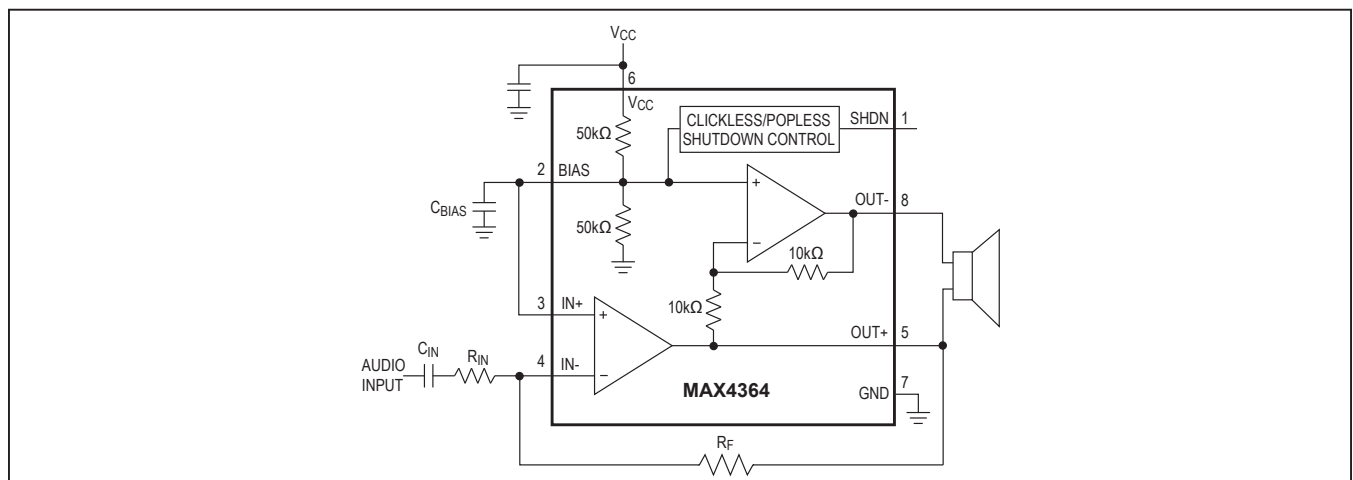

μMAX is a registered trademark of Maxim Integrated Products, Inc.



Absolute Maximum Ratings

V_{CC}, OUT_ to GND.....-0.3V to +6V
 IN+, IN-, BIAS, SHDN to GND -0.3V to (V_{CC} + 0.3V)
 Output Short Circuit (OUT+ to OUT-) (Note 1)..... Continuous
 Continuous Power Dissipation (T_A = +70°C)
 8-Pin μMAX (derate 4.8mW/°C above +70°C).....388mW
 8-Pin TDFN (derate 24.4mW/°C above +70°C)1951mW
 8-Pin SO (derate 7.8mW/°C above +70°C).....623mW

Junction Temperature.....+150°C
 Operating Temperature Range..... -40°C to +85°C
 Storage Temperature Range..... -65°C to +150°C
 Lead Temperature (soldering, 10s)+300°C
 Soldering Temperature (reflow)+260°C

Note 1: Continuous power dissipation must also be observed.

Stresses beyond those listed under "Absolute Maximum Ratings" may cause permanent damage to the device. These are stress ratings only, and functional operation of the device at these or any other conditions beyond those indicated in the operational sections of the specifications is not implied. Exposure to absolute maximum rating conditions for extended periods may affect device reliability.

Package Thermal Characteristics (Note 2)

μMAX

Junction-to-Ambient Thermal Resistance (θ_{JA})206.3°C/W
 Junction-to-Case Thermal Resistance (θ_{JC}).....42°C/W

TDFN

Junction-to-Ambient Thermal Resistance (θ_{JA})41°C/W
 Junction-to-Case Thermal Resistance (θ_{JC}).....8°C/W

SO

Junction-to-Ambient Thermal Resistance (θ_{JA})128.4°C/W
 Junction-to-Case Thermal Resistance (θ_{JC}).....36°C/W

Note 2: Package thermal resistances were obtained using the method described in JEDEC specification JESD51-7, using a four-layer board. For detailed information on package thermal considerations, refer to www.maximintegrated.com/thermal-tutorial.

Electrical Characteristics—5V

(V_{CC} = 5V, R_L = ∞, C_{BIAS} = 1μF to GND, V_{SHDN} = V_{GND}, T_A = +25°C, unless otherwise noted.) (Note 3)

PARAMETER	SYMBOL	CONDITIONS		MIN	TYP	MAX	UNITS
Supply Voltage Range	V _{CC}	Inferred from PSRR test		2.7		5.5	V
Supply Current	I _{CC}	(Note 4)	MAX4364		7	13	mA
			MAX4364, T _A = T _{MIN} to T _{MAX}			17	
			MAX4365		5	8	
			MAX4365, T _A = T _{MIN} to T _{MAX}			11	
Shutdown Supply Current	I _{SHDN}	V _{SHDN} = V _{CC}			0.01	4	μA
SHDN Threshold	V _{IH}	T _A = +25°C		V _{CC} x 0.7		V	
		T _A = -40°C to +85°C (Note 5)		V _{CC} x 0.7			
	V _{IL}	T _A = +25°C		V _{CC} x 0.3			
		T _A = -40°C to +85°C (Note 5)		V _{CC} x 0.3			
Common-Mode Bias Voltage	V _{BIAS}	(Note 6)		V _{CC} /2 - 5%	V _{CC} /2	V _{CC} /2 + 5%	V
Output Offset Voltage	V _{OS}	IN- = OUT+, IN+ = BIAS (Note 7)			±1	±10	mV
Power-Supply Rejection Ratio	PSRR	V _{CC} = 2.7V to 5.5V		DC	55	75	dB
		V _{RIPPLE} = 200mV _{P-P} , R _L = 8Ω		217Hz		68	
				1kHz		58	
Output Power	P _{OUT}	R _L = 8Ω, THD+N = 1%, f _{IN} = 1kHz (Note 8)		MAX4364	1200	1400	mW
				MAX4365	800	1000	

Electrical Characteristics—5V (continued)(V_{CC} = 5V, R_L = ∞, C_{BIAS} = 1μF to GND, V_{SHDN} = V_{GND}, T_A = +25°C, unless otherwise noted.) (Note 3)

PARAMETER	SYMBOL	CONDITIONS	MIN	TYP	MAX	UNITS
Total Harmonic Distortion Plus Noise	THD+N	A _V = -2V/V, R _L = 8Ω, f _{IN} = 1kHz (Notes 5, 9)	MAX4364, P _{OUT} = 1W	0.04		%
			MAX4365, P _{OUT} = 750mW	0.1		
Noise		f _{IN} = 10kHz, BW = 22Hz to 22kHz	12			μV _{RMS}
Short-Circuit Current	I _{SC}	OUT+ to OUT- (Note 10)	600			mA
Thermal Shutdown Threshold			160			°C
Thermal Shutdown Hysteresis			15			°C
Power-Up Time	t _{PU}	T _A = +25°C	50			ms
		C _{BIAS} = 0.22μF, T _A = -40°C to +85°C (Note 5)	14	35		
Shutdown Time	t _{SHDN}		10			μs
Enable Time from Shutdown	t _{ENABLE}	T _A = +25°C	50			ms
		C _{BIAS} = 0.22μF, T _A = -40°C to +85°C (Note 5)	12	35		

Electrical Characteristics—3V(V_{CC} = 3V, R_L = ∞, C_{BIAS} = 1μF to GND, V_{SHDN} = V_{GND}, T_A = +25°C, unless otherwise noted.) (Note 3)

PARAMETER	SYMBOL	CONDITIONS	MIN	TYP	MAX	UNITS
Supply Current	I _{CC}	(Note 4)	MAX4364	6		mA
			MAX4365	4.5		
Shutdown Supply Current	I _{SHDN}	V _{SHDN} = V _{CC}	10			nA
Output Power	P _{OUT}	R _L = 8Ω, THD+N = 1%, f _{IN} = 1kHz (Note 8)	MAX4364	400	500	mW
			MAX4365	350	450	
Total Harmonic Distortion Plus Noise	THD + N	A _V = -2V/V, R _L = 8Ω, f _{IN} = 1kHz (Notes 5, 9)	MAX4364, P _{OUT} = 400mW	0.05		%
			MAX4365, P _{OUT} = 400mW	0.08		

Note 3: All specifications are 100% tested at T_A = +25°C.**Note 4:** Quiescent power-supply current is specified and tested with no load on the outputs. Quiescent power-supply current depends on the offset voltage when a practical load is connected to the amplifier.**Note 5:** Guaranteed by design, not production tested.**Note 6:** Common-mode bias voltage is the voltage on BIAS and is nominally V_{CC}/2.**Note 7:** Maximum differential-output offset voltage is tested in a unity-gain configuration. V_{OS} = V_{OUT+} - V_{OUT-}.**Note 8:** Output power is specified by a combination of a functional output-current test, and characterization analysis.**Note 9:** Measurement bandwidth for THD+N is 22Hz to 22kHz.**Note 10:** Extended short-circuit conditions result in a pulsed output.

Typical Operating Characteristics

($V_{CC} = 5V$, THD+N measurement bandwidth = 22Hz to 22kHz, $T_A = +25^\circ C$, unless otherwise noted.)

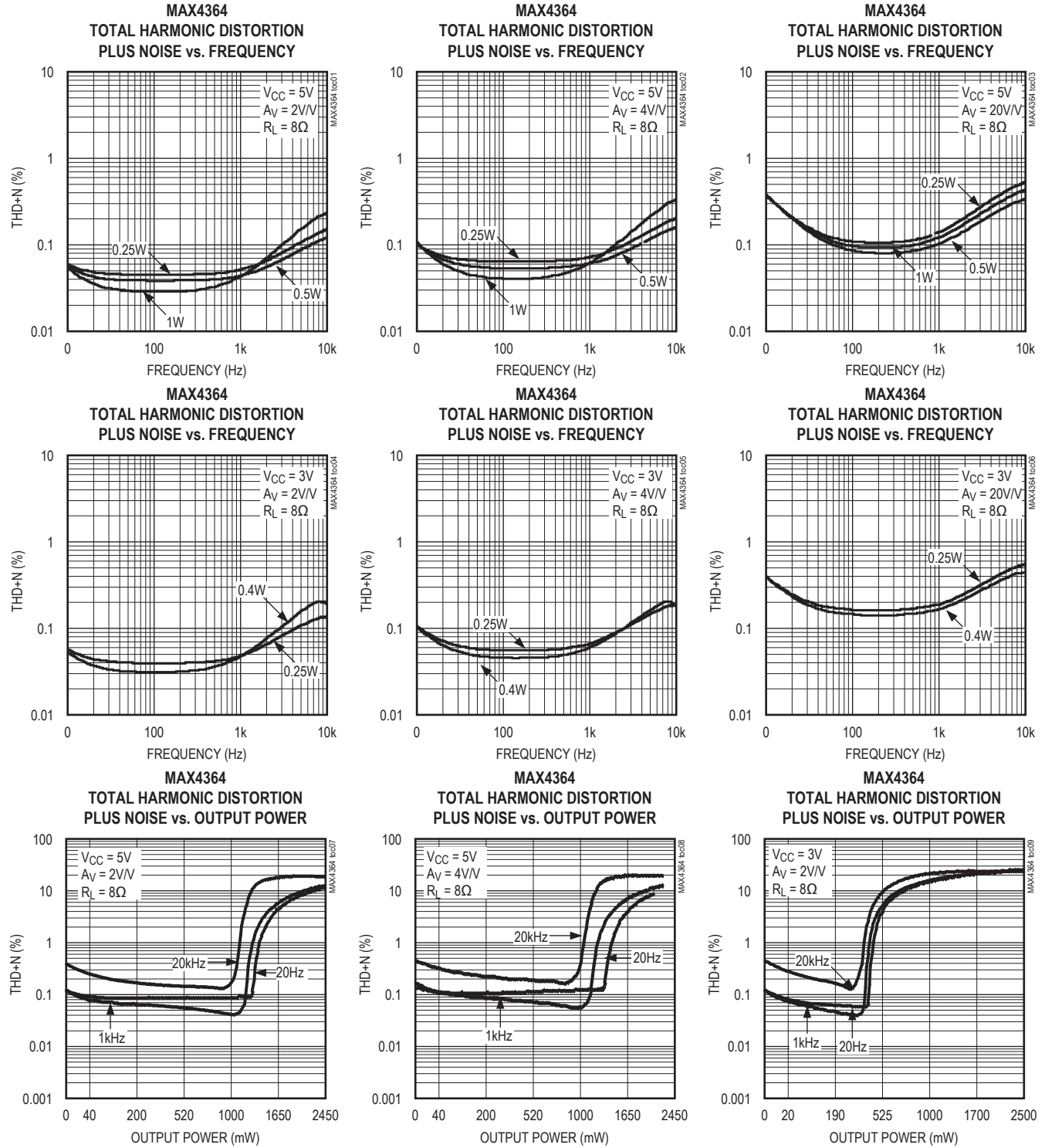

Typical Operating Characteristics (continued)

($V_{CC} = 5V$, THD+N measurement bandwidth = 22Hz to 22kHz, $T_A = +25^\circ C$, unless otherwise noted.)

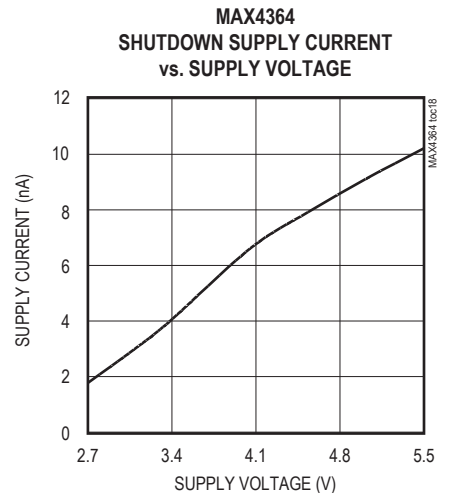
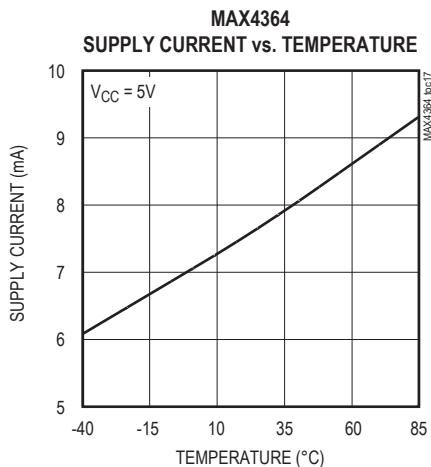
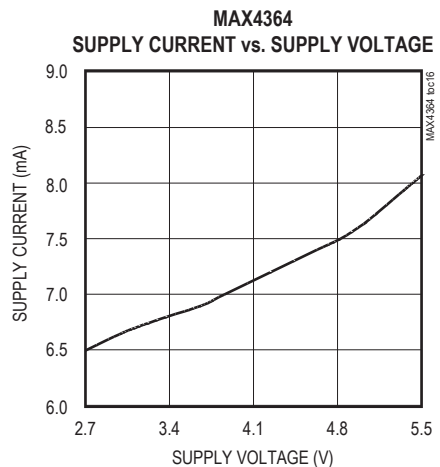
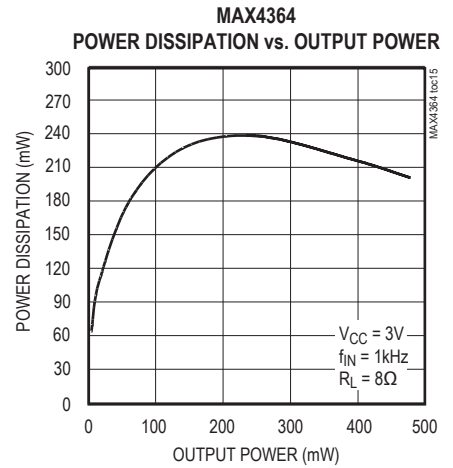
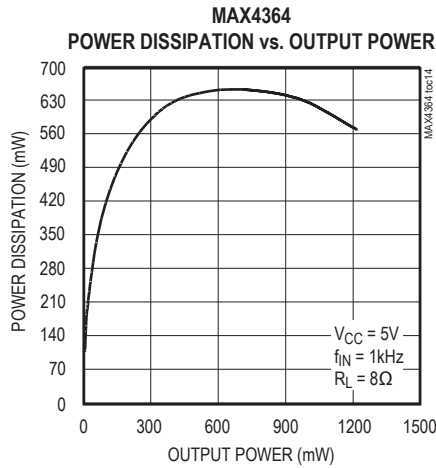
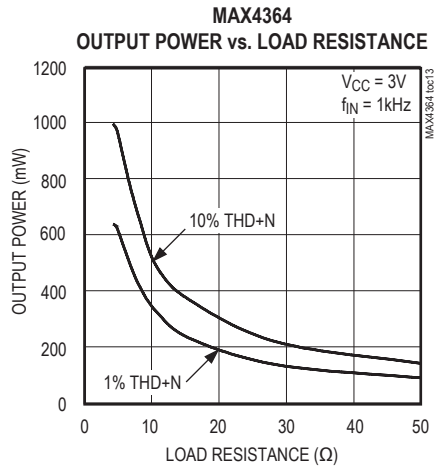
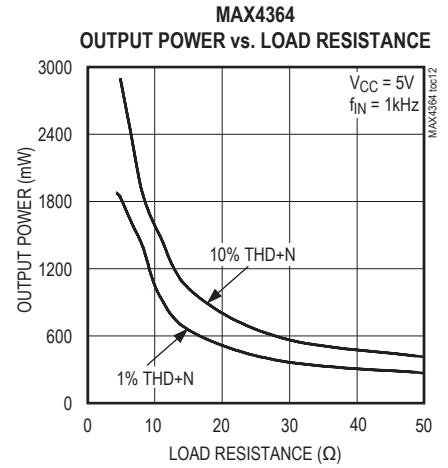
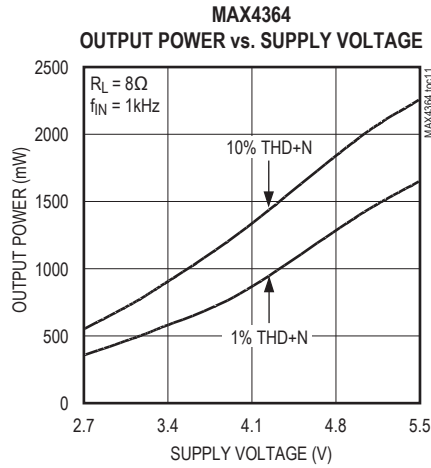
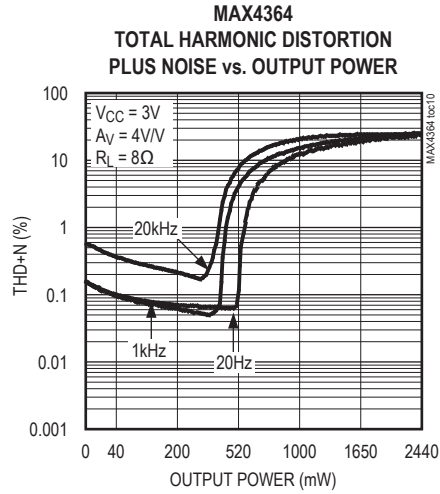

Typical Operating Characteristics (continued)

($V_{CC} = 5V$, THD+N measurement bandwidth = 22Hz to 22kHz, $T_A = +25^\circ C$, unless otherwise noted.)

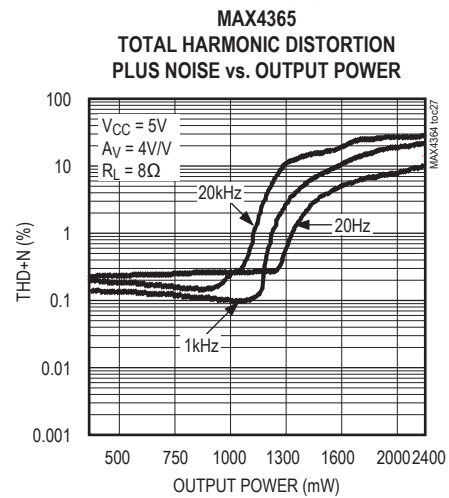
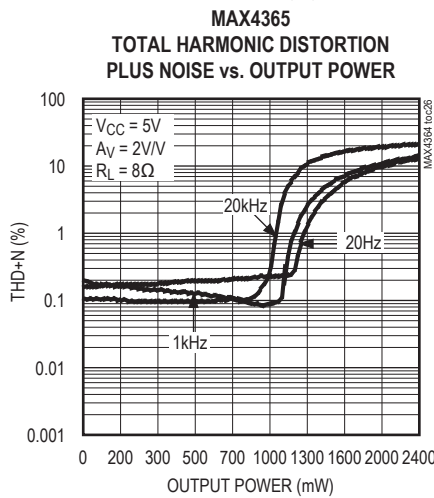
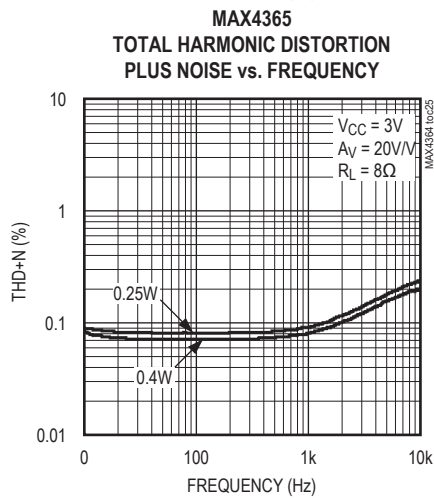
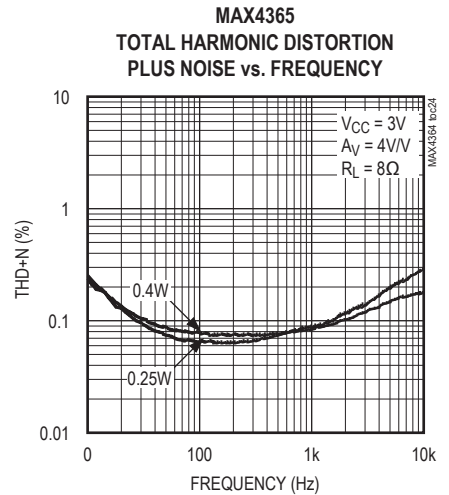
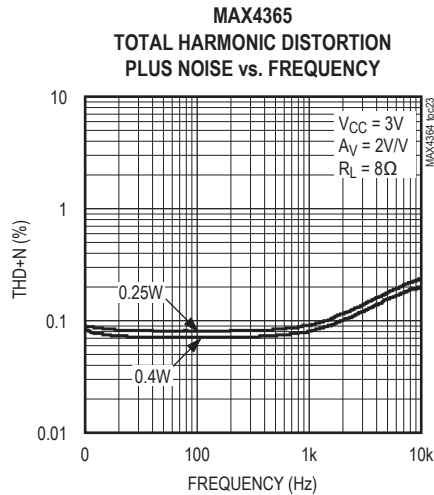
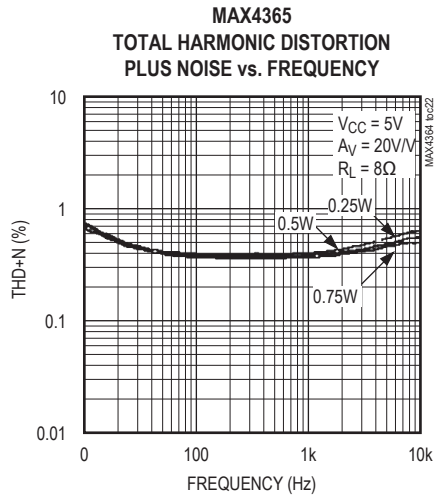
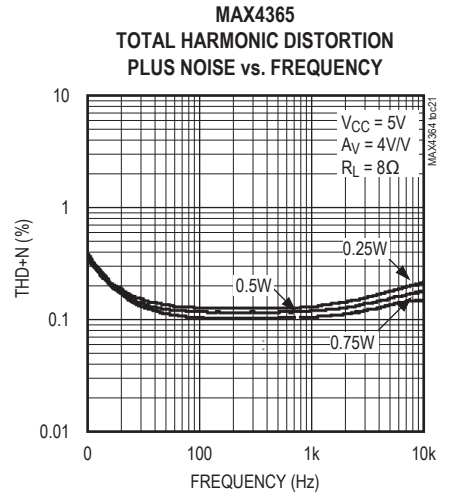
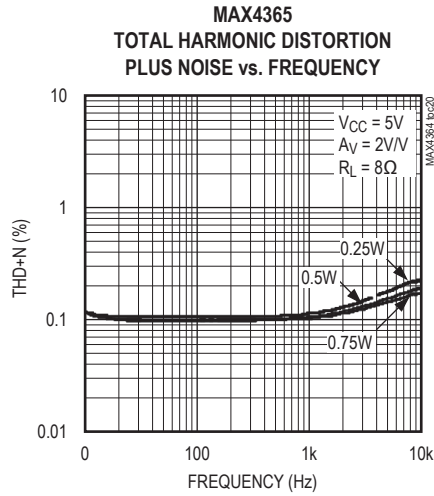
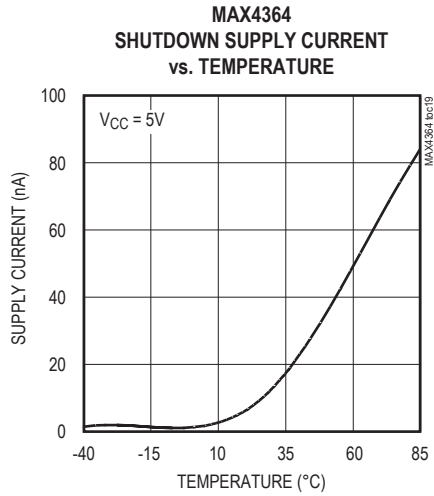

Typical Operating Characteristics (continued)

($V_{CC} = 5V$, THD+N measurement bandwidth = 22Hz to 22kHz, $T_A = +25^\circ C$, unless otherwise noted.)

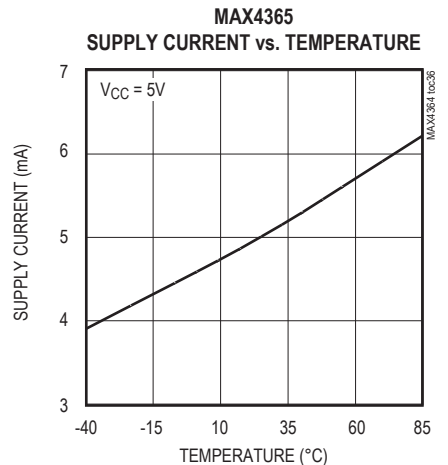
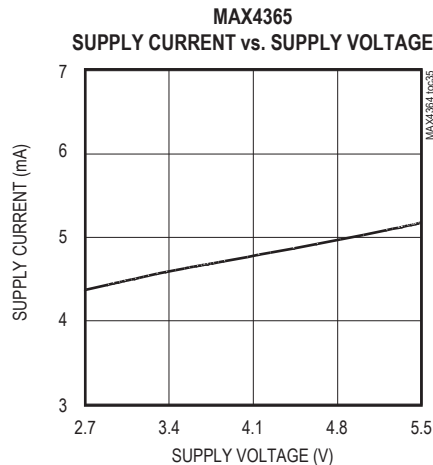
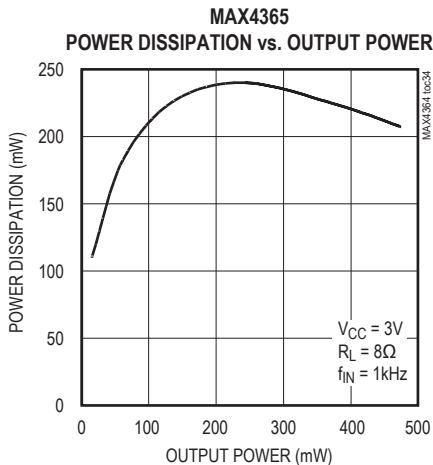
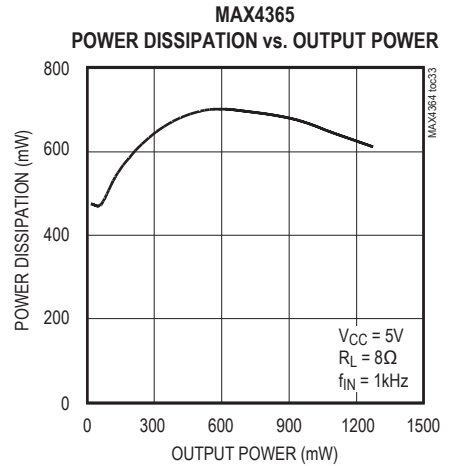
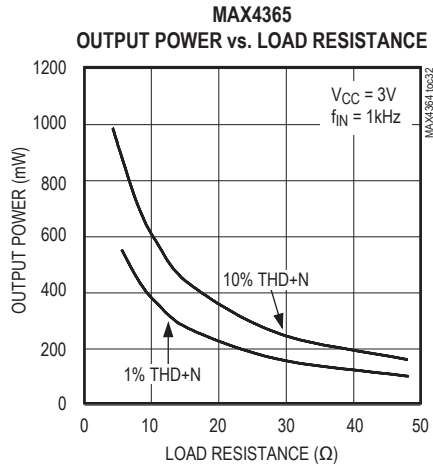
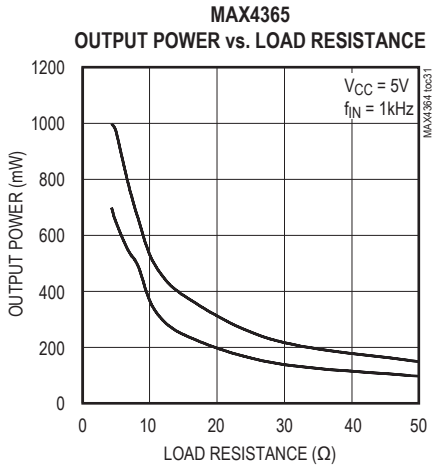
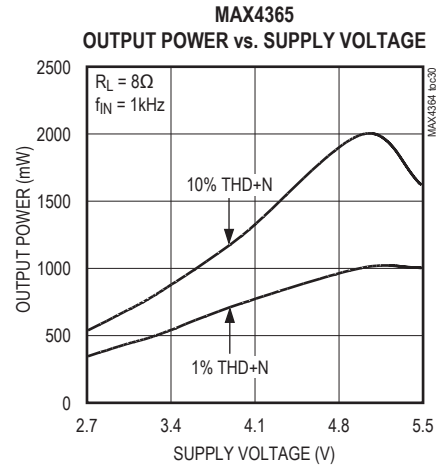
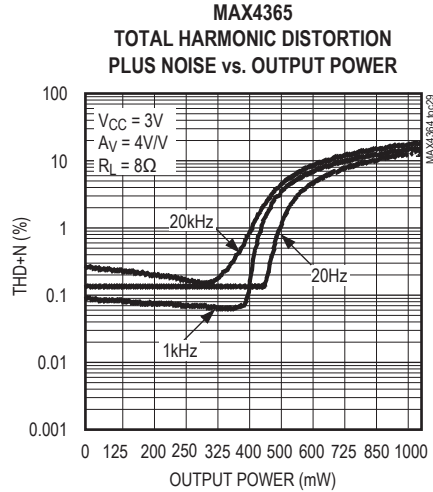
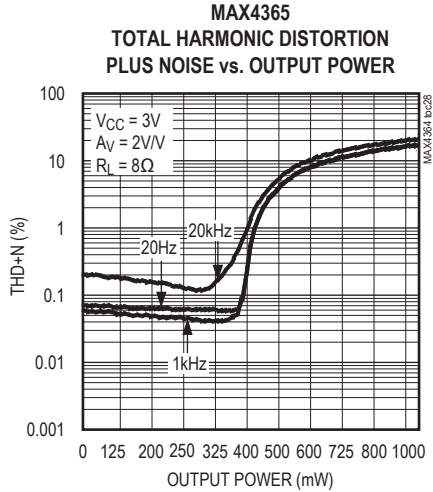

Typical Operating Characteristics (continued)

($V_{CC} = 5V$, THD+N measurement bandwidth = 22Hz to 22kHz, $T_A = +25^\circ C$, unless otherwise noted.)

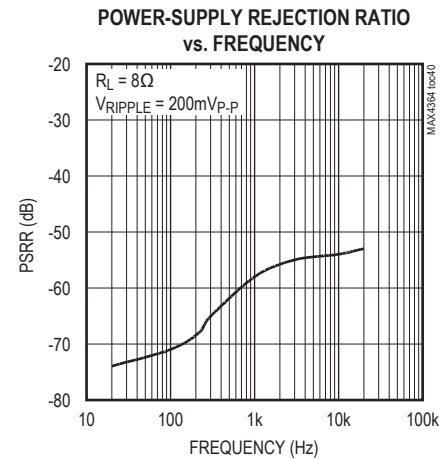
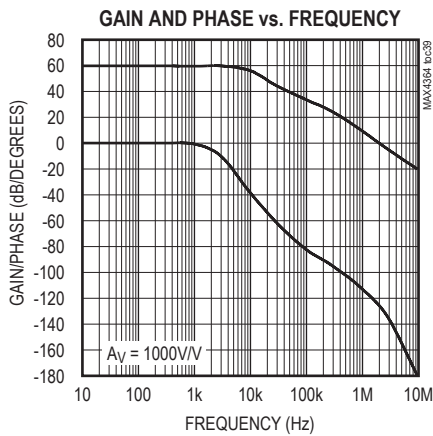
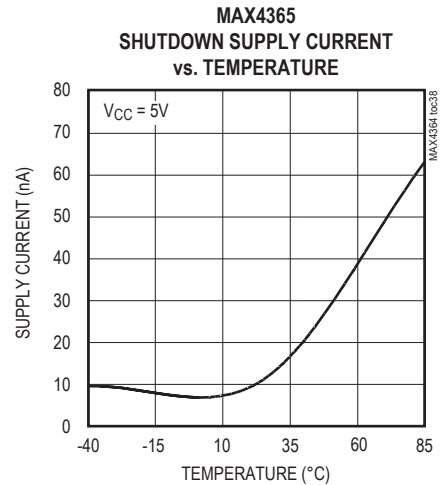
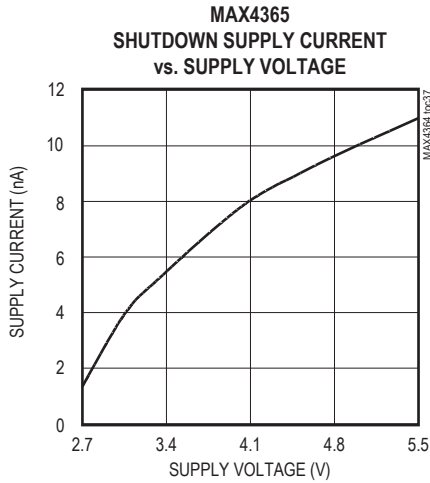

Pin Description

PIN		NAME	FUNCTION
MAX4364	MAX4365		
SO	μ MAX/TDFN		
1	7	SHDN	Active-High Shutdown. Connect SHDN to GND for normal operation.
2	1	BIAS	DC Bias Bypass. See <i>BIAS Capacitor</i> section for capacitor selection. Connect C_{BIAS} capacitor from BIAS to GND.
3	2	IN+	Noninverting Input
4	4	IN-	Inverting Input
5	5	OUT+	Bridged Amplifier Positive Output
6	6	V_{CC}	Power Supply
7	3	GND	Ground
8	8	OUT-	Bridged Amplifier Negative Output
—	—	EP	Exposed Pad (TDFN Only). Internally connected to GND. Connect to a large ground plane to maximize thermal performance. Not intended as an electrical connection point.

Detailed Description

The MAX4364/MAX4365 bridged audio power amplifiers can deliver 1.4W into 8Ω (MAX4364) or 1W into 8Ω (MAX4365) while operating from a single 5V supply. These devices consist of two high-output-current op amps configured as a bridge-tied load (BTL) amplifier (see *Typical Application Circuit/Functional Diagram*). The gain of the device is set by the closed-loop gain of the input op amp. The output of the first amplifier serves as the input to the second amplifier, which is configured as an inverting unity-gain follower in both devices. This results in two outputs, identical in magnitude, but 180° out of phase.

BIAS

The MAX4364/MAX4365 feature an internally generated common-mode bias voltage of $V_{CC}/2$ referenced to GND. BIAS provides both click-and-pop suppression and the DC bias level for the audio signal. BIAS is internally connected to the noninverting input of one amplifier, and should be connected to the noninverting input of the other amplifier for proper signal biasing (see *Typical Application Circuit/Functional Diagram*). Choose the value of the bypass capacitor as described in the *BIAS Capacitor* section.

Shutdown

The MAX4364/MAX4365 feature a 10nA, low-power shutdown mode that reduces quiescent current consumption. Pulling SHDN high disables the device's bias circuitry, the amplifier outputs go high impedance, and BIAS is driven to GND. Connect SHDN to GND for normal operation.

Current Limit

The MAX4364/MAX4365 feature a current limit that protects the device during output short circuit and overload conditions. When both amplifier outputs are shorted to either V_{CC} or GND, the short-circuit protection is enabled and the amplifier enters a pulsing mode, reducing the average output current to a safe level. The amplifier remains in this mode until the overload or short-circuit condition is removed.

Applications Information

Bridge-Tied Load

The MAX4364/MAX4365 are designed to drive a load differentially in a BTL configuration. The BTL configuration (Figure 1) offers advantages over the single-ended configuration, where one side of the load is connected to ground. Driving the load differentially doubles the output voltage compared to a single-ended amplifier under similar conditions. Thus, the differential gain of the device is

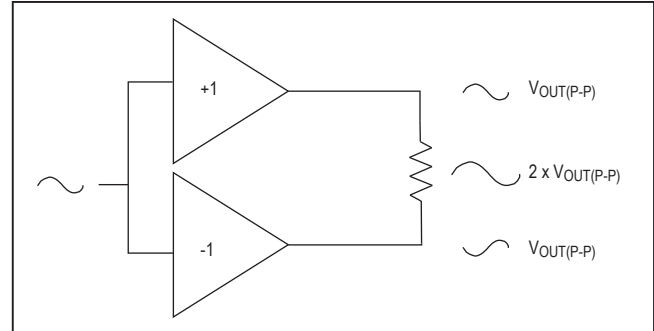

Figure 1. Bridge-Tied Load Configuration

twice the closed-loop gain of the input amplifier. The effective gain is given by:

$$A_{VD} = 2 \times \frac{R_F}{R_{IN}}$$

Substituting $2 V_{OUT(P-P)}$ into the following equations yields four times the output power due to doubling of the output voltage.

$$V_{RMS} = \frac{V_{OUT(P-P)}}{2\sqrt{2}}$$

$$P_{OUT} = \frac{V_{RMS}^2}{R_L}$$

Since the differential outputs are biased at midsupply, there is no net DC voltage across the load. This eliminates the need for DC-blocking capacitors required for single-ended amplifiers. These capacitors can be large, expensive, consume board space, and degrade low-frequency performance.

Power Dissipation

Under normal operating conditions, the MAX4364/MAX4365 can dissipate a significant amount of power. The maximum power dissipation for each package is given in the *Absolute Maximum Ratings* section under Continuous Power Dissipation or can be calculated by the following equation:

$$P_{DISSPKG(MAX)} = \frac{T_{J(MAX)} - T_A}{\theta_{JA}}$$

where $T_{J(MAX)}$ is +150°C, T_A is the ambient temperature and θ_{JA} is the reciprocal of the derating factor in °C/W as specified in the *Package Thermal Characteristics* section. For example, θ_{JA} of the μ MAX package is 206.3°C/W.

The increase in power delivered by the BTL configuration directly results in an increase in internal power dissipation over the single-ended configuration. The maximum power dissipation for a given V_{CC} and load is given by the following equation:

$$P_{DISSP(MAX)} = \frac{2V_{CC}^2}{\pi^2 R_L}$$

If the power dissipation for a given application exceeds the maximum allowed for a given package, reduce V_{CC} , increase load impedance, decrease the ambient temperature or add heat sinking to the device. Large output, supply, and ground PC board traces improve the maximum power dissipation in the package.

Thermal-overload protection limits total power dissipation in the MAX4364/MAX4365. When the junction temperature exceeds $+160^\circ\text{C}$, the thermal protection circuitry disables the amplifier output stage. The amplifiers are enabled once the junction temperature cools by 15°C . This results in a pulsing output under continuous thermal overload conditions as the device heats and cools.

The MAX4365 TDFN package features an exposed thermal pad on its underside. This pad lowers the thermal resistance of the package by providing a direct heat conduction path from the die to the PC board. Connect the exposed thermal pad to circuit ground by using a large pad, ground plane, or multiple vias to the ground plane.

Efficiency

The efficiency of the MAX4364/MAX4365 is calculated by taking the ratio of the power delivered to the load to the power consumed from the power supply. Output power is calculated by the following equations:

$$P_{OUT} = \frac{V_{PEAK}^2}{2R_L}$$

where V_{PEAK} is half the peak-to-peak output voltage. In BTL amplifiers, the supply current waveform is a fullwave rectified sinusoid with the magnitude proportional to the peak output voltage and load. Calculate the supply current and power drawn from the power supply by the following:

$$I_{CC} = \frac{2V_{PEAK}}{\pi R_L}$$

$$P_{IN} = V_{CC} \left(\frac{2V_{PEAK}}{\pi R_L} \right)$$

The efficiency of the MAX4364/MAX4365 is:

$$\eta = \frac{P_{OUT}}{P_{IN}} = \frac{\pi \sqrt{\frac{P_{OUT} R_L}{2}}}{2V_{CC}}$$

The device efficiency values in Table 1 are calculated based on the previous equation and do include the effects of quiescent current. Note that efficiency is low at low output-power levels, but remains relatively constant at normal operating, output-power levels.

Component Selection

Gain-Setting Resistors

External feedback components set the gain of both devices. Resistors R_F and R_{IN} (see *Typical Application Circuit/Functional Diagram*) set the gain of the amplifier as follows:

$$A_{VD} = 2 \times \frac{R_F}{R_{IN}}$$

Optimum output offset is achieved when $R_F = 20\text{k}\Omega$. Vary the gain by changing the value of R_{IN} . When using the MAX4364/MAX4365 in a high-gain configuration (greater than 8V/V), a feedback capacitor may be required to maintain stability (see Figure 2). C_F and R_F limit the bandwidth of the device, preventing high-frequency oscillations. Ensure that the pole created by C_F and R_F is not within the frequency band of interest.

Input Filter

The input capacitor (C_{IN}), in conjunction with R_{IN} forms a highpass filter that removes the DC bias from an incoming signal. The AC-coupling capacitor allows the amplifier to bias the signal to an optimum DC level. Assuming zero source impedance, the -3dB point of the highpass filter is given by:

$$f_{-3\text{dB}} = \frac{1}{2\pi R_{IN} C_{IN}}$$

Choose R_{IN} according to the *Gain-Setting Resistors* section. Choose C_{IN} such that $f_{-3\text{dB}}$ is well below the lowest frequency of interest. Setting $f_{-3\text{dB}}$ too high affects the low-frequency response of the amplifier. Use capacitors whose dielectrics have low-voltage coeffi-

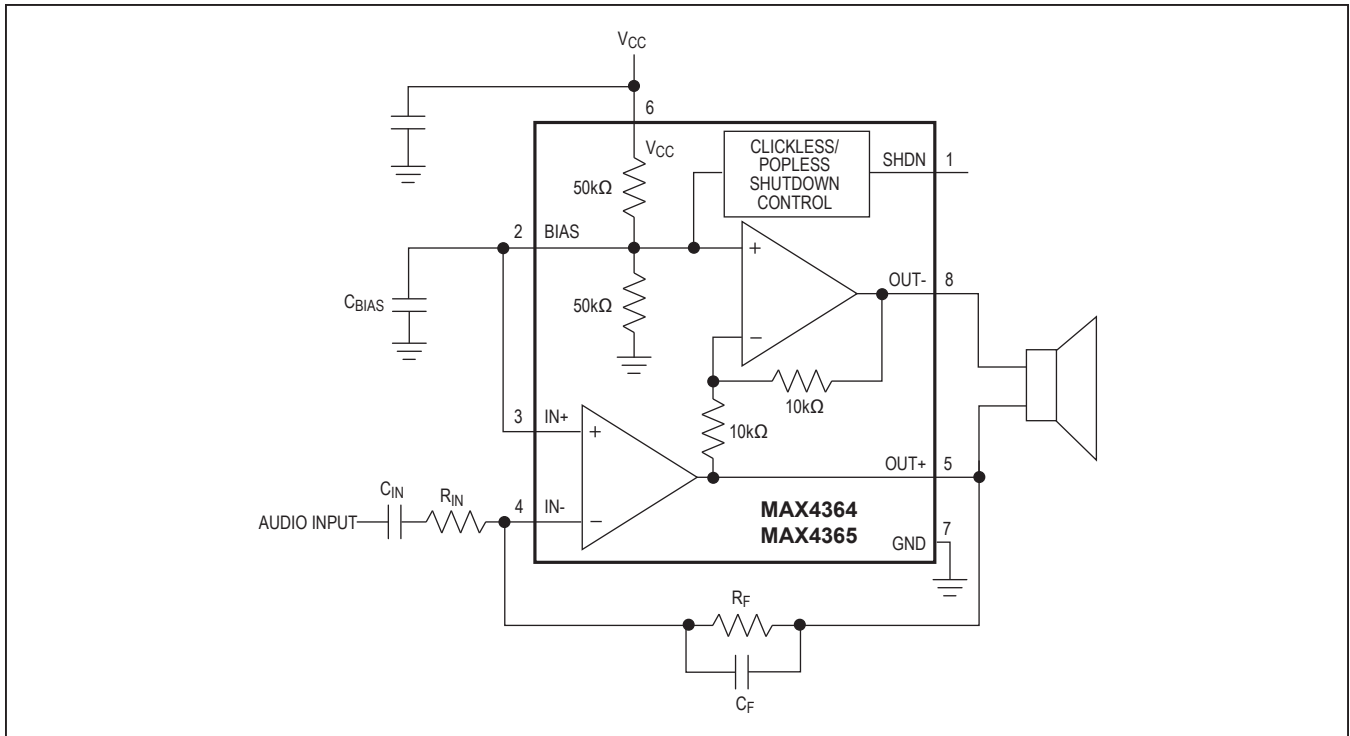

Figure 2. High-Gain Configuration

Table 1. Efficiency in a 5V, 8Ω BTL System

OUTPUT POWER (W)	INTERNAL POWER DISSIPATION (W)	EFFICIENCY (%)
0.25	0.55	31.4
0.50	0.63	44.4
0.75	0.63	54.4
1.00	0.59	62.8
1.25	0.53	70.2
1.40	0.48	74.3

ponents, such as tantalum or aluminum electrolytic. Capacitors with high-voltage coefficients, such as ceramics, may result in an increase distortion at low frequencies.

Other considerations when designing the input filter include the constraints of the overall system, the actual frequency band of interest and click-and-pop suppression. Although high-fidelity audio calls for a flat gain response between 20Hz and 20kHz, portable voicereproduction devices such as cellular phones and twoway radios need only concentrate on the frequency range of the spoken

human voice (typically 300Hz to 3.5kHz). In addition, speakers used in portable devices typically have a poor response below 150Hz. Taking these two factors into consideration, the input filter may not need to be designed for a 20Hz to 20kHz response, saving both board space and cost due to the use of smaller capacitors.

BIAS Capacitor

The BIAS bypass capacitor, CBIAS, improves PSRR and THD+N by reducing power-supply noise at the commonmode bias node, and serves as the primary click-and-pop suppression mechanism. CBIAS is fed from an internal 25kΩ source, and controls the rate at which the common-mode bias voltage rises at startup and falls during shutdown. For optimum click-and-pop suppression, ensure that the input capacitor (CIN) is fully charged (ten time constants) before CBIAS. The value of CBIAS for best click-and-pop suppression is given by:

$$C_{BIAS} \geq 10 \left[\frac{C_{IN} R_{IN}}{25k\Omega} \right]$$

In addition, a larger CBIAS value yields higher PSRR.

Clickless/Popless Operation

Proper selection of AC-coupling capacitors (C_{IN}) and C_{BIAS} achieves clickless/popless shutdown and startup. The value of C_{BIAS} determines the rate at which the mid-rail bias voltage rises on startup and falls when entering shutdown. The size of the input capacitor also affects clickless/popless operation. On startup, C_{IN} is charged to its quiescent DC voltage through the feedback resistor (R_F) from the output. This current creates a voltage transient at the amplifier's output, which can result in an audible pop. Minimizing the size of C_{IN} reduces this effect, optimizing click-and-pop suppression.

Supply Bypassing

Proper supply bypassing ensures low-noise, low-distortion performance. Place a 0.1 μ F ceramic capacitor in parallel with a 10 μ F ceramic capacitor from V_{CC} to GND. Locate the bypass capacitors as close to the device as possible.

Adding Volume Control

The addition of a digital potentiometer provides simple volume control. Figure 3 shows the MAX4364/MAX4365 with the MAX5407 log taper digital potentiometer used as an input attenuator. Connect the high terminal of the MAX5407 to the audio input, the low terminal to ground and the wiper to C_{IN} . Setting the wiper to the top position

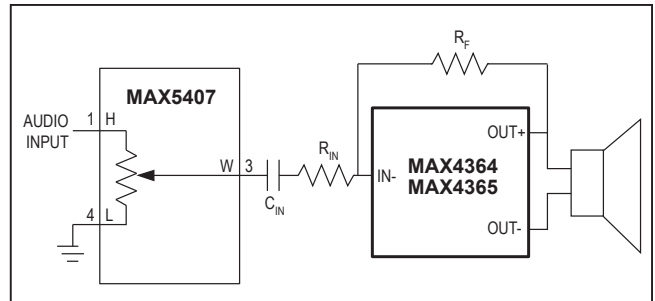

Figure 3. MAX4364/MAX4365 and MAX5160 Volume Control Circuit

passes the audio signal unattenuated. Setting the wiper to the lowest position fully attenuates the input.

Layout Considerations

Good layout improves performance by decreasing the amount of stray capacitance and noise at the amplifier's inputs and outputs. Decrease stray capacitance by minimizing PC board trace lengths, using surface-mount components and placing external components as close to the device as possible. Also refer to the *Power Dissipation* section for heatsinking considerations.

Chip Information

PROCESS: BiCMOS

Pin Configurations

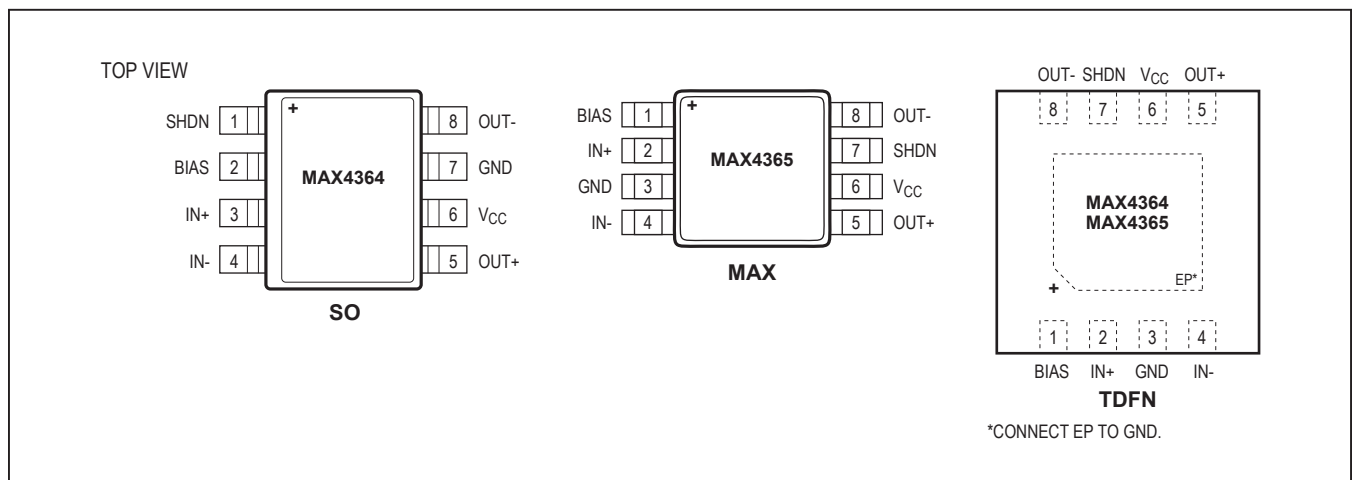

Package Information

For the latest package outline information and land patterns (footprints), go to www.maximintegrated.com/packages. Note that a "+", "#", or "-" in the package code indicates RoHS status only. Package drawings may show a different suffix character, but the drawing pertains to the package regardless of RoHS status.

PACKAGE TYPE	PACKAGE CODE	OUTLINE NO.	LAND PATTERN NO.
8 SO	S8+19F	21-0041	90-0096
8 μ MAX	U8+1	21-0036	90-0092
8 TDFN	T833+2	21-0137	90-0059

Revision History

REVISION NUMBER	REVISION DATE	DESCRIPTION	PAGES CHANGED
4	5/11	Added EP information to <i>Pin Description</i> ; updated <i>Ordering Information</i> and <i>Pin Configurations</i> for lead-free parts; updated specifications in <i>Absolute Maximum Ratings</i> , <i>Package Thermal Characteristics</i> and <i>Electrical Characteristics</i> sections	1, 2, 3, 8, 9, 12, 13
5	6/17	Changed orderable part number from MAX4364ESA+ to MAX4364ESA/V+T in <i>Ordering Information</i> table	1
6	10/17	Updated SO package code	13
7	11/17	Changed SO package code from S8-19F to S8+19F	13

For pricing, delivery, and ordering information, please contact Maxim Direct at 1-888-629-4642, or visit Maxim Integrated's website at www.maximintegrated.com.

Maxim Integrated cannot assume responsibility for use of any circuitry other than circuitry entirely embodied in a Maxim Integrated product. No circuit patent licenses are implied. Maxim Integrated reserves the right to change the circuitry and specifications without notice at any time. The parametric values (min and max limits) shown in the *Electrical Characteristics* table are guaranteed. Other parametric values quoted in this data sheet are provided for guidance.

Mouser Electronics

Authorized Distributor

Click to View Pricing, Inventory, Delivery & Lifecycle Information:

[Analog Devices Inc.:](#)

[MAX4364ESA+](#) [MAX4364ESA+T](#) [MAX4364ESA/V+](#) [MAX4364ESA/V+T](#)