

YASMEEN-50-WW

~60° wide beam. Assembly with holder C (LEDiL HEKLA) and B (BJB and B+W). Black and white versions.

SPECIFICATION:

Dimensions	Ø 49.9 mm
Height	28.1 mm
Fastening	socket
ROHS compliant	yes ⓘ



MATERIALS:

Component	Type	Material	Colour	Finish
YASMEEN-50-WW	Single lens	PMMA	clear	
YASMEEN-50-HLD2-C	Holder C	PC	black	
YASMEEN-50-HLD2-B	Holder B	PC	black	
YASMEEN-50-HLD2-C-WHT	Holder C	PC	white	
YASMEEN-50-HLD2-B-WHT	Holder B	PC	white	

ORDERING INFORMATION:

Component	Qty in box	MOQ	MPQ	Box weight (kg)
C17237_YASMEEN-50-WW	252	112	28	7.9
Assembly				
CP18747_YASMEEN-50-WW-B2-WHT	252	112	28	9.3
CP18740_YASMEEN-50-WW-C2-WHT	252	112	28	9.1
CP18733_YASMEEN-50-WW-B2	252	112	28	9.3
CP18726_YASMEEN-50-WW-C2	252	112	28	9.1

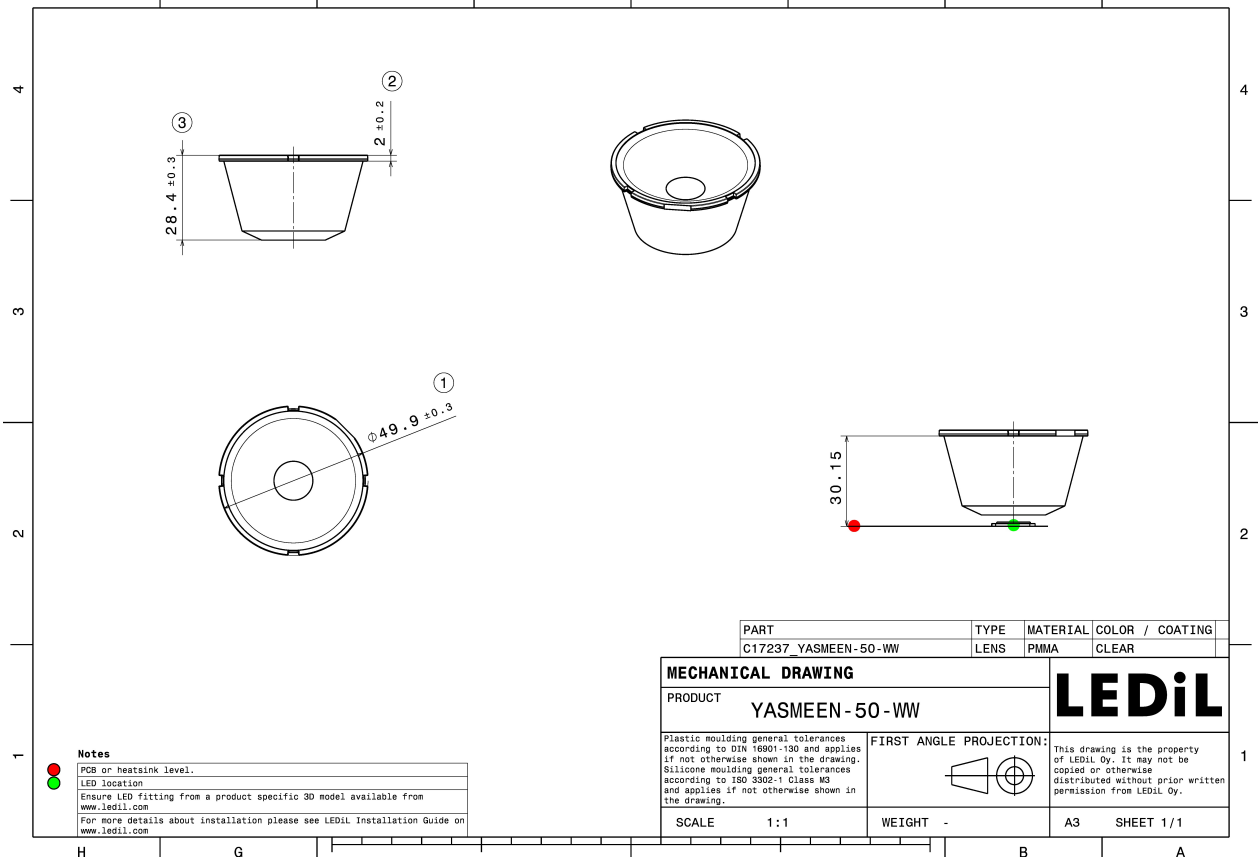
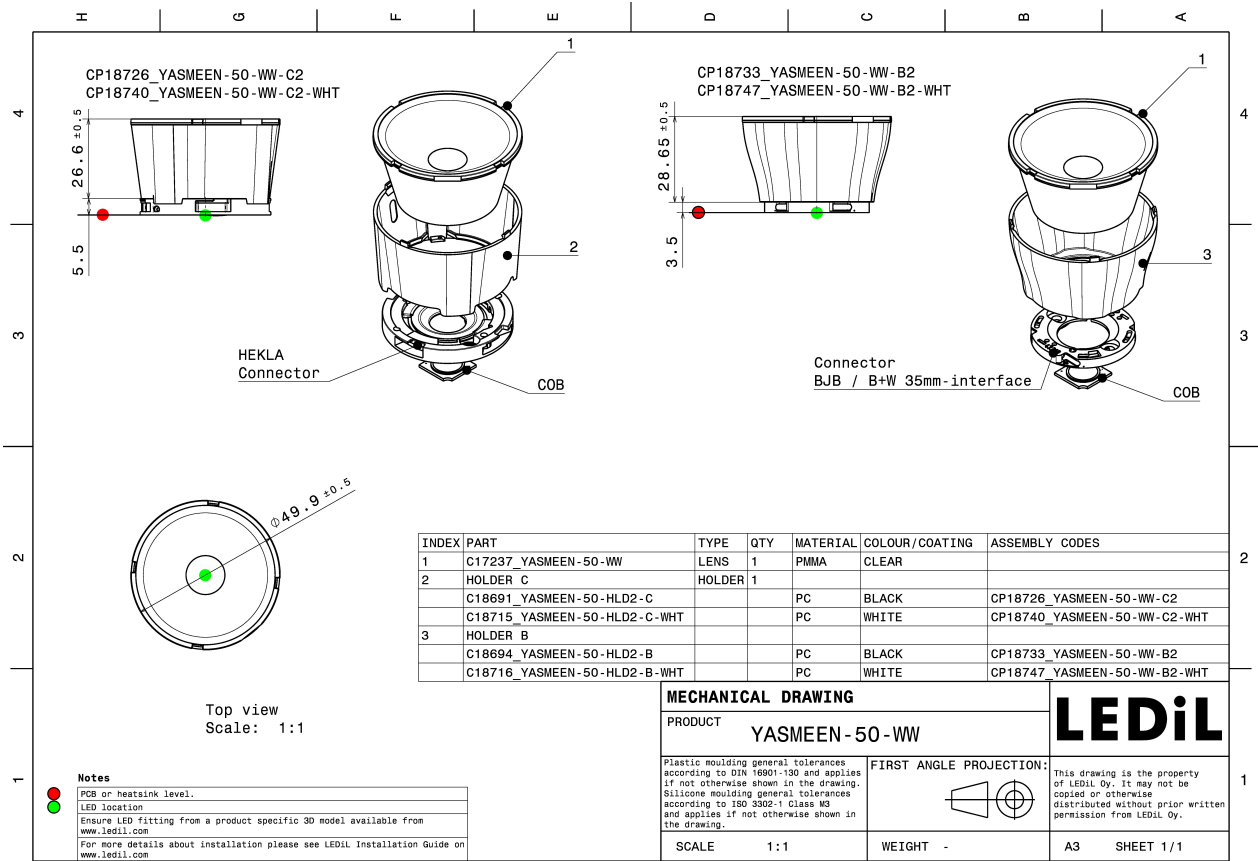

See also our general installation guide: www.ledil.com/installation_guide

OPTICAL RESULTS (MEASURED):

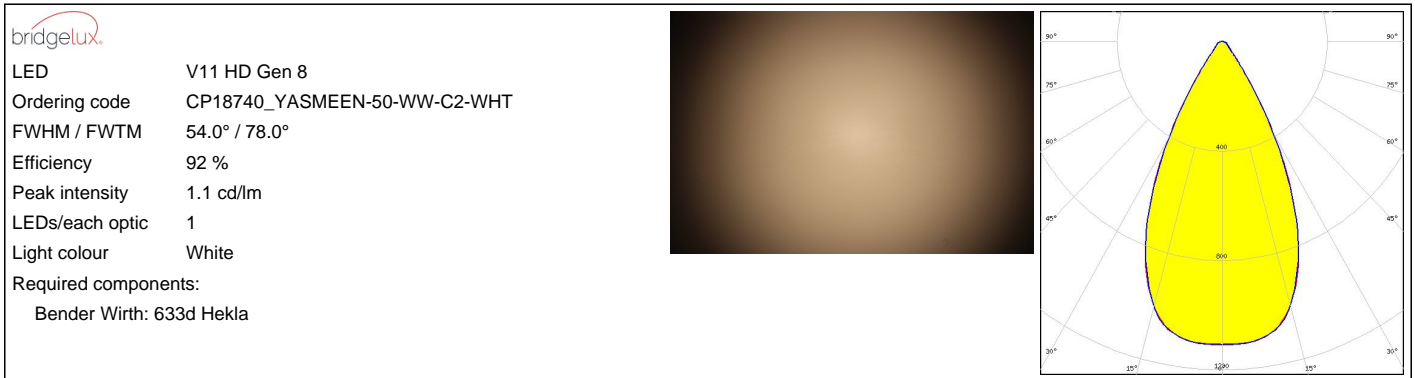

OPTICAL RESULTS (MEASURED):



LED V4 HD Gen 7
Ordering code CP18740_YASMEEN-50-WW-C2-WHT
FWHM / FWTM 54.0° / 76.0°
Efficiency 91 %
Peak intensity 1.1 cd/lm
LEDs/each optic 1
Light colour White
Required components:
 F15253_HEKLA-SOCKET-A

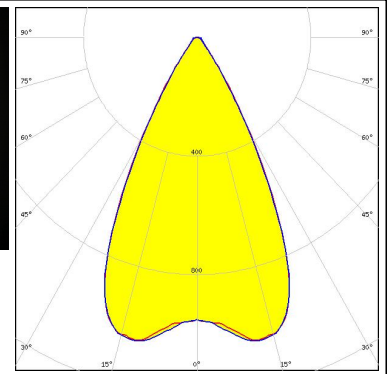
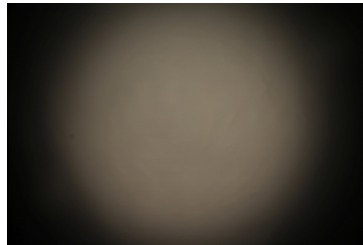

LED V6 HD Gen 7
Ordering code CP18726_YASMEEN-50-WW-C2
FWHM / FWTM 55.0° / 75.0°
Efficiency 83 %
Peak intensity 1 cd/lm
LEDs/each optic 1
Light colour White
Required components:
 F15255_HEKLA-SOCKET-C

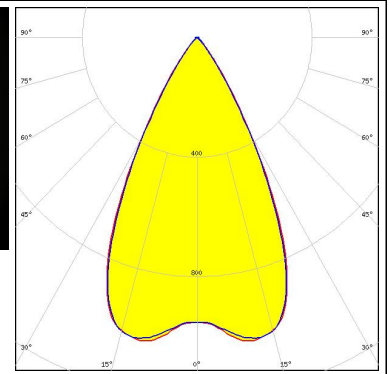

LED V6 HD Gen 7
Ordering code CP18740_YASMEEN-50-WW-C2-WHT
FWHM / FWTM 55.0° / 77.0°
Efficiency 91 %
Peak intensity 1.1 cd/lm
LEDs/each optic 1
Light colour White
Required components:
 F15255_HEKLA-SOCKET-C

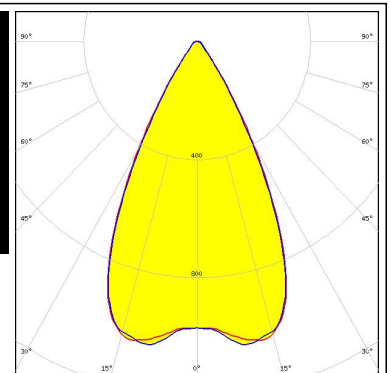
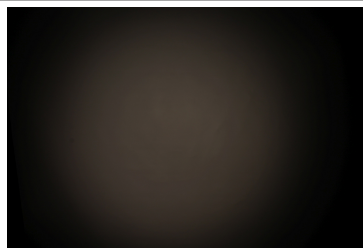

LED V8 Gen 8
Ordering code CP18726_YASMEEN-50-WW-C2
FWHM / FWTM 55.0° / 76.0°
Efficiency 83 %
Peak intensity 1 cd/lm
LEDs/each optic 1
Light colour White
Required components:
 F15253_HEKLA-SOCKET-A

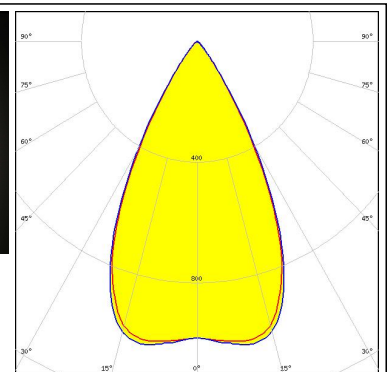
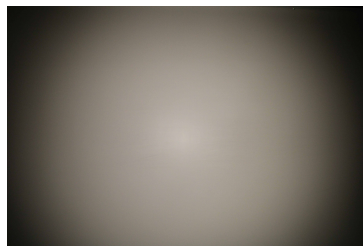

OPTICAL RESULTS (MEASURED):



OPTICAL RESULTS (MEASURED):

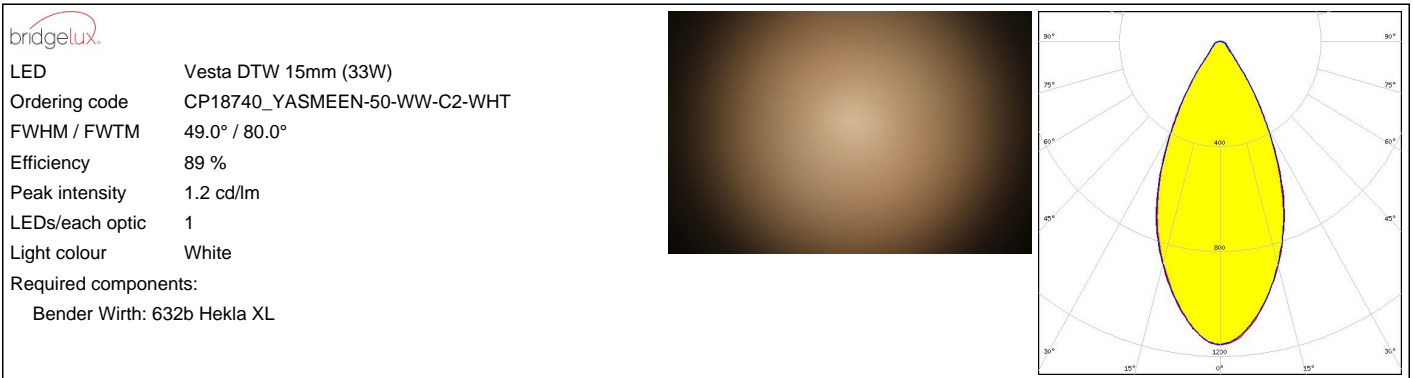

OPTICAL RESULTS (MEASURED):

CITIZEN

LED CLL02x/CLU02x (LES10)
Ordering code CP18740_YASMEEN-50-WW-C2-WHT
FWHM / FWTM 54.0° / 78.0°
Efficiency 91 %
Peak intensity 1.1 cd/lm
LEDs/each optic 1
Light colour White
Required components:
F17435_HEKLA-G2-C

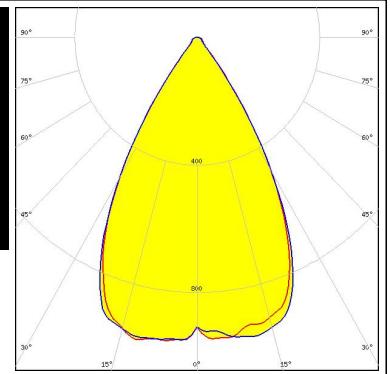
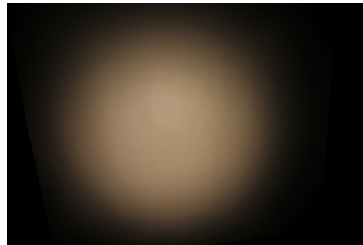

CITIZEN

LED CLL02x/CLU02x (LES10)
Ordering code CP18726_YASMEEN-50-WW-C2
FWHM / FWTM 54.0° / 76.0°
Efficiency 83 %
Peak intensity 1.1 cd/lm
LEDs/each optic 1
Light colour White
Required components:
F17435_HEKLA-G2-C

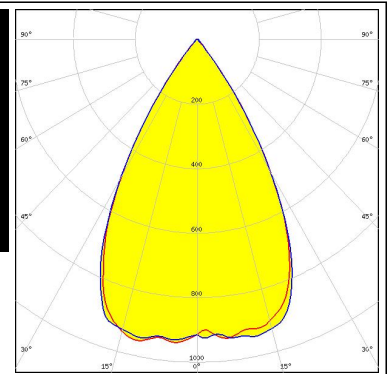

CITIZEN

LED CLU700/701/702/703
Ordering code CP18726_YASMEEN-50-WW-C2
FWHM / FWTM 55.0° / 75.0°
Efficiency 84 %
Peak intensity 1 cd/lm
LEDs/each optic 1
Light colour White
Required components:
F17435_HEKLA-G2-C

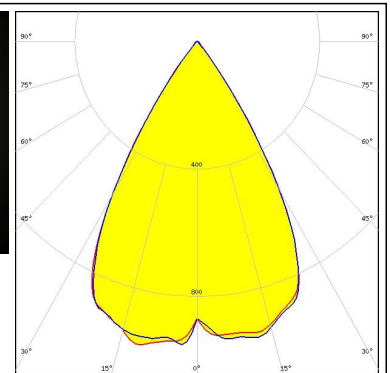
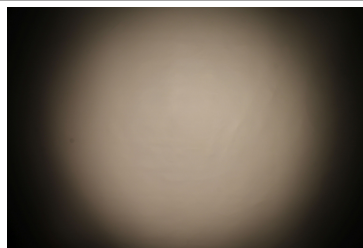

CITIZEN

LED CLU700/701/702/703
Ordering code CP18740_YASMEEN-50-WW-C2-WHT
FWHM / FWTM 55.0° / 77.0°
Efficiency 92 %
Peak intensity 1.1 cd/lm
LEDs/each optic 1
Light colour White
Required components:
F17435_HEKLA-G2-C

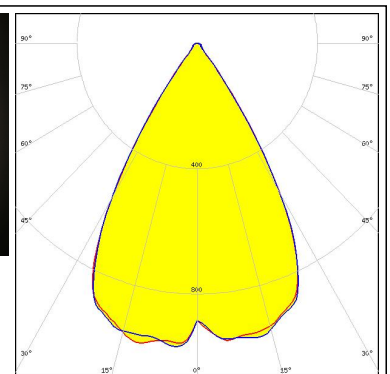
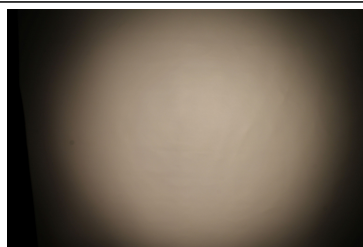

OPTICAL RESULTS (MEASURED):

CITIZEN

LED CLU7A2/7A3
Ordering code CP18726_YASMEEN-50-WW-C2
FWHM / FWTM 55.0° / 75.0°
Efficiency 84 %
Peak intensity 1.1 cd/lm
LEDs/each optic 1
Light colour White
Required components:
F17435_HEKLA-G2-C

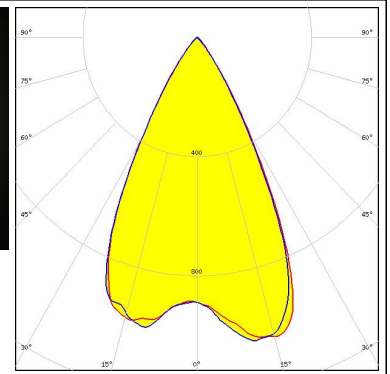
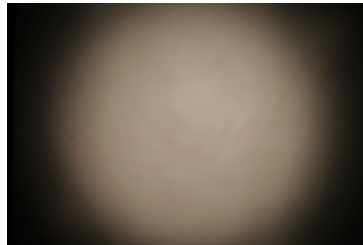

CITIZEN

LED CLU7A2/7A3
Ordering code CP18740_YASMEEN-50-WW-C2-WHT
FWHM / FWTM 55.0° / 76.0°
Efficiency 92 %
Peak intensity 1.1 cd/lm
LEDs/each optic 1
Light colour White
Required components:
F17435_HEKLA-G2-C

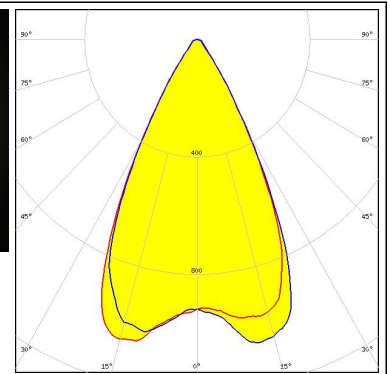
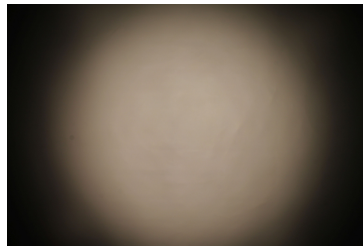

CITIZEN

LED CLU7B2
Ordering code CP18726_YASMEEN-50-WW-C2
FWHM / FWTM 54.0° / 74.0°
Efficiency 84 %
Peak intensity 1.1 cd/lm
LEDs/each optic 1
Light colour White
Required components:
F17435_HEKLA-G2-C

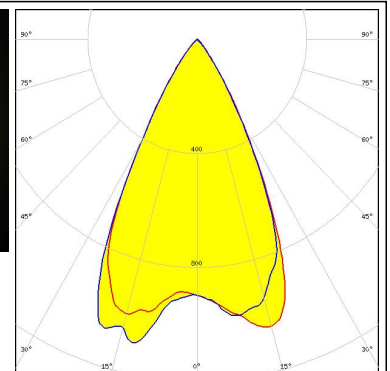
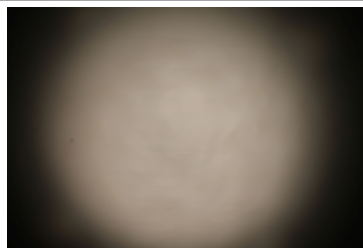

CITIZEN

LED CLU7B2
Ordering code CP18740_YASMEEN-50-WW-C2-WHT
FWHM / FWTM 55.0° / 76.0°
Efficiency 92 %
Peak intensity 1.1 cd/lm
LEDs/each optic 1
Light colour White
Required components:
F17435_HEKLA-G2-C

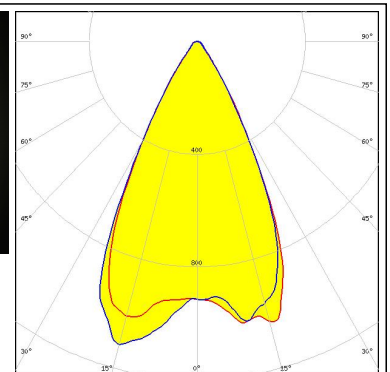
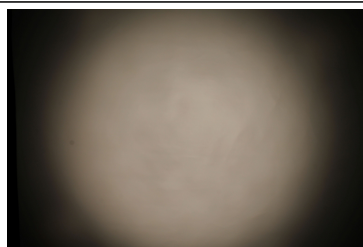

OPTICAL RESULTS (MEASURED):



LED CMA1516
Ordering code CP18726_YASMEEN-50-WW-C2
FWHM / FWTM 54.0° / 76.0°
Efficiency 83 %
Peak intensity 1 cd/lm
LEDs/each optic 1
Light colour White
Required components:
F17436_HEKLA-G2-D

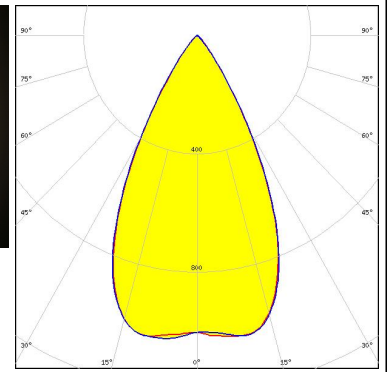
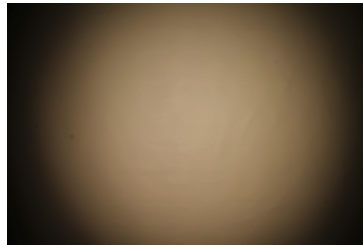

LED CMA1516
Ordering code CP18740_YASMEEN-50-WW-C2-WHT
FWHM / FWTM 54.0° / 78.0°
Efficiency 91 %
Peak intensity 1.1 cd/lm
LEDs/each optic 1
Light colour White
Required components:
F17436_HEKLA-G2-D

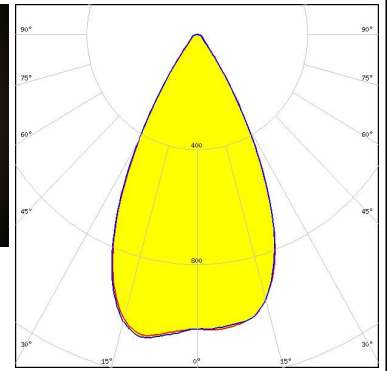

LED CMT14xx
Ordering code CP18726_YASMEEN-50-WW-C2
FWHM / FWTM 54.0° / 76.0°
Efficiency 83 %
Peak intensity 1.1 cd/lm
LEDs/each optic 1
Light colour White
Required components:
F17435_HEKLA-G2-C

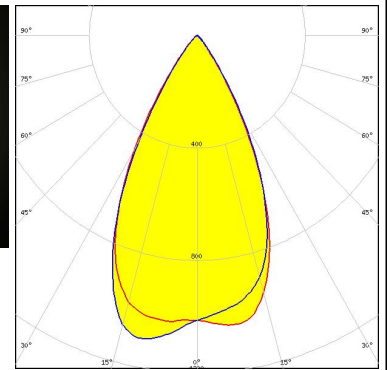

LED CMT14xx
Ordering code CP18740_YASMEEN-50-WW-C2-WHT
FWHM / FWTM 54.0° / 78.0°
Efficiency 91 %
Peak intensity 1.1 cd/lm
LEDs/each optic 1
Light colour White
Required components:
F17435_HEKLA-G2-C

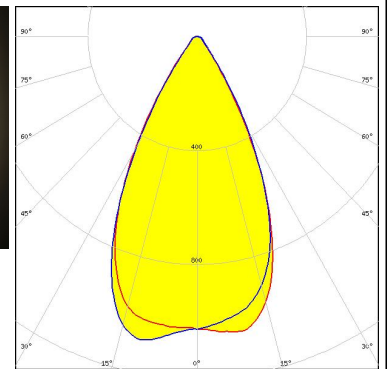

OPTICAL RESULTS (MEASURED):



LED CMU10xx
Ordering code CP18726_YASMEEN-50-WW-C2
FWHM / FWTM 48.0° / 72.0°
Efficiency 81 %
Peak intensity 1.3 cd/lm
LEDs/each optic 1
Light colour White
Required components:
 F17435_HEKLA-G2-C

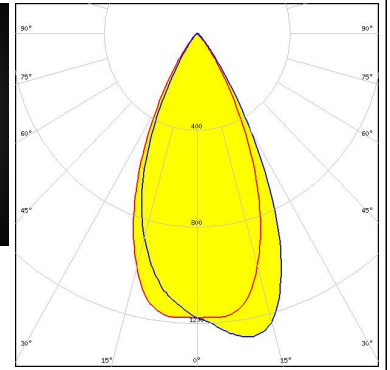
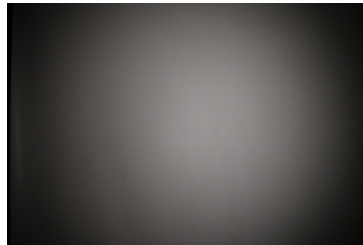

LED CXA/B 13xx
Ordering code CP18726_YASMEEN-50-WW-C2
FWHM / FWTM 55.0° / 74.0°
Efficiency 84 %
Peak intensity 1.1 cd/lm
LEDs/each optic 1
Light colour White
Required components:
 F17439_HEKLA-G2-J

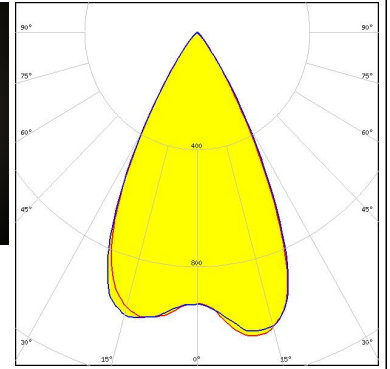

LED CXA/B 13xx
Ordering code CP18740_YASMEEN-50-WW-C2-WHT
FWHM / FWTM 55.0° / 77.0°
Efficiency 92 %
Peak intensity 1.1 cd/lm
LEDs/each optic 1
Light colour White
Required components:
 F17439_HEKLA-G2-J

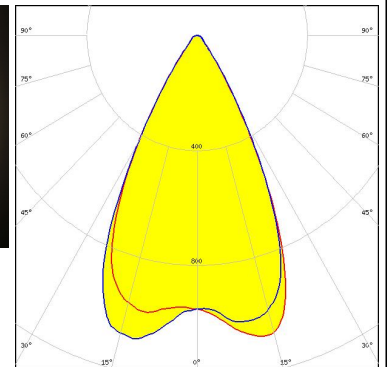
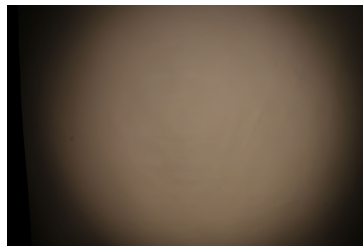

LED CXA/B 15xx
Ordering code CP18726_YASMEEN-50-WW-C2
FWHM / FWTM 54.0° / 75.0°
Efficiency 84 %
Peak intensity 1.1 cd/lm
LEDs/each optic 1
Light colour White
Required components:
 F17436_HEKLA-G2-D

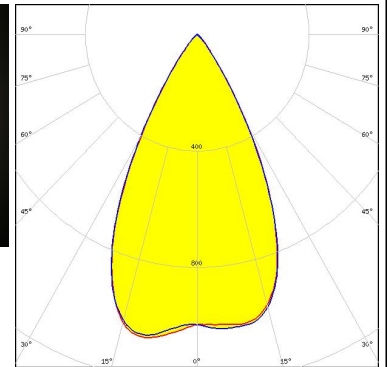
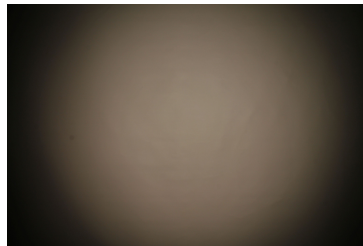

OPTICAL RESULTS (MEASURED):



LED CXA/B 15xx
Ordering code CP18740_YASMEEN-50-WW-C2-WHT
FWHM / FWTM 55.0° / 78.0°
Efficiency 92 %
Peak intensity 1.1 cd/lm
LEDs/each optic 1
Light colour White
Required components:
 F17436_HEKLA-G2-D

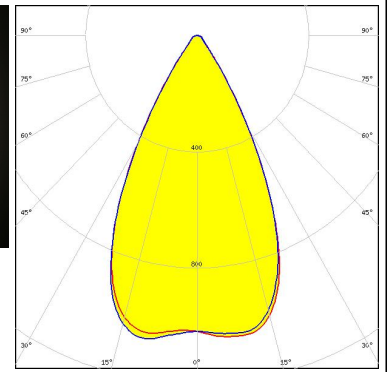
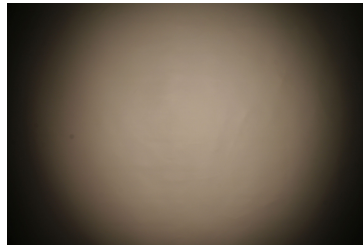

LED LEDIM/C6
Ordering code CP18726_YASMEEN-50-WW-C2
FWHM / FWTM 57.0° / 78.0°
Efficiency 83 %
Peak intensity 1 cd/lm
LEDs/each optic 1
Light colour White
Required components:
 F17438_HEKLA-G2-I

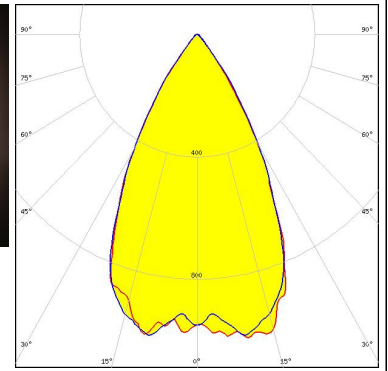

LED LUXEON CoB 1202/1203
Ordering code CP18726_YASMEEN-50-WW-C2
FWHM / FWTM 54.0° / 75.0°
Efficiency 83 %
Peak intensity 1.1 cd/lm
LEDs/each optic 1
Light colour White
Required components:
 F17437_HEKLA-G2-H

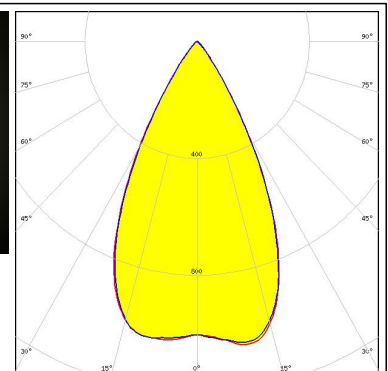
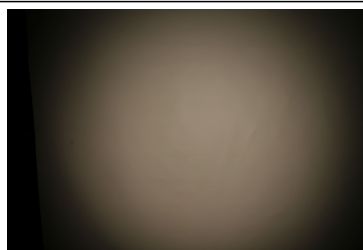

LED LUXEON CoB 1202/1203
Ordering code CP18740_YASMEEN-50-WW-C2-WHT
FWHM / FWTM 54.0° / 77.0°
Efficiency 91 %
Peak intensity 1.1 cd/lm
LEDs/each optic 1
Light colour White
Required components:
 F17437_HEKLA-G2-H

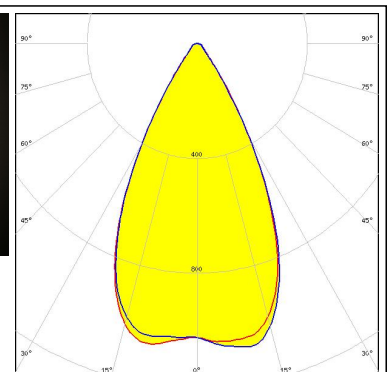
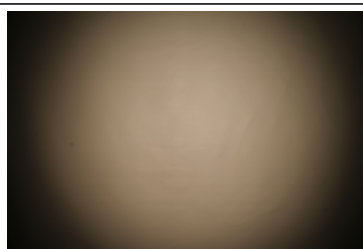

OPTICAL RESULTS (MEASURED):

LUMILEDS

LED LUXEON CoB 1204HD
 Ordering code CP18726_YASMEEN-50-WW-C2
 FWHM / FWTM 53.0° / 75.0°
 Efficiency 83 %
 Peak intensity 1.1 cd/lm
 LEDs/each optic 1
 Light colour White
 Required components:
 F17437_HEKLA-G2-H

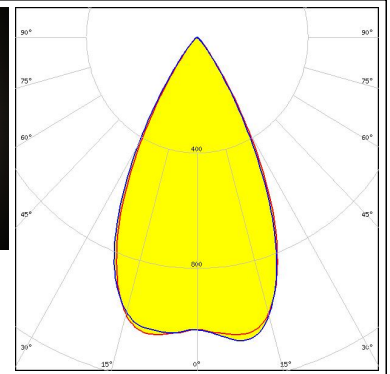
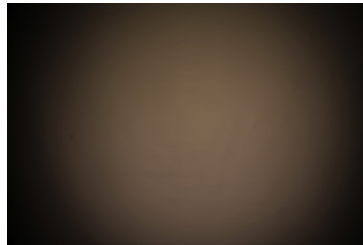

LUMILEDS

LED LUXEON CoB 1204HD
 Ordering code CP18740_YASMEEN-50-WW-C2-WHT
 FWHM / FWTM 54.0° / 77.0°
 Efficiency 92 %
 Peak intensity 1.1 cd/lm
 LEDs/each optic 1
 Light colour White
 Required components:
 F17437_HEKLA-G2-H

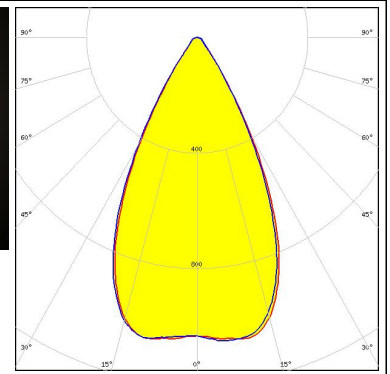
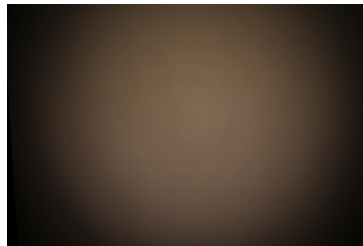

LUMILEDS

LED LUXEON CoB M02/M03
 Ordering code CP18726_YASMEEN-50-WW-C2
 FWHM / FWTM 54.0° / 75.0°
 Efficiency 84 %
 Peak intensity 1.1 cd/lm
 LEDs/each optic 1
 Light colour White
 Required components:
 F17436_HEKLA-G2-D

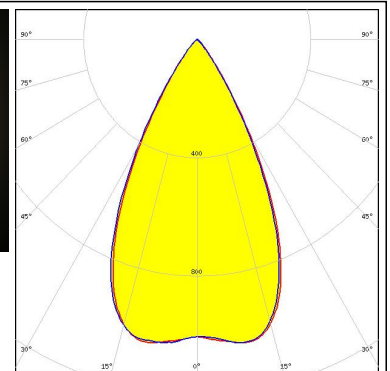
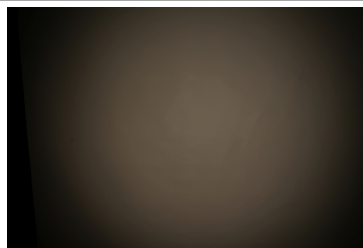

LUMILEDS

LED LUXEON CoB M02/M03
 Ordering code CP18740_YASMEEN-50-WW-C2-WHT
 FWHM / FWTM 54.0° / 77.0°
 Efficiency 92 %
 Peak intensity 1.1 cd/lm
 LEDs/each optic 1
 Light colour White
 Required components:
 F17436_HEKLA-G2-D

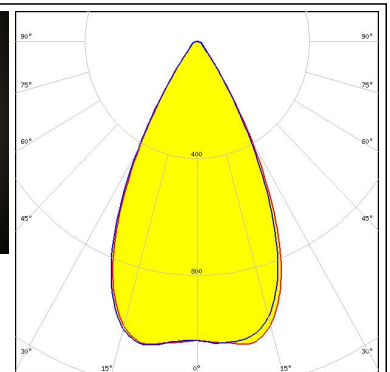
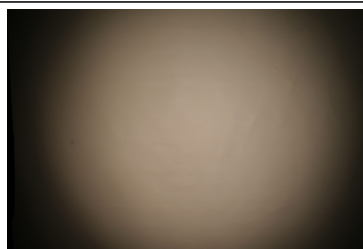

OPTICAL RESULTS (MEASURED):

LUMILEDS

LED LUXEON CoB S01
 Ordering code CP18726_YASMEEN-50-WW-C2
 FWHM / FWTM 55.0° / 75.0°
 Efficiency 84 %
 Peak intensity 1.1 cd/lm
 LEDs/each optic 1
 Light colour White
 Required components:
 F17439_HEKLA-G2-J

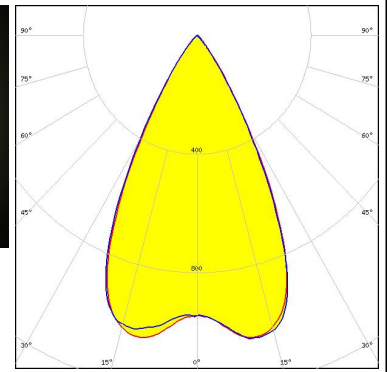
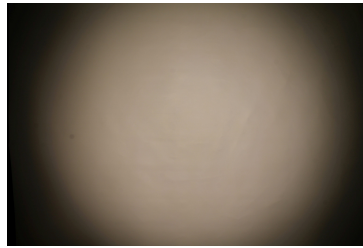

LUMILEDS

LED LUXEON CoB S01
 Ordering code CP18740_YASMEEN-50-WW-C2-WHT
 FWHM / FWTM 55.0° / 77.0°
 Efficiency 92 %
 Peak intensity 1.1 cd/lm
 LEDs/each optic 1
 Light colour White
 Required components:
 F17439_HEKLA-G2-J

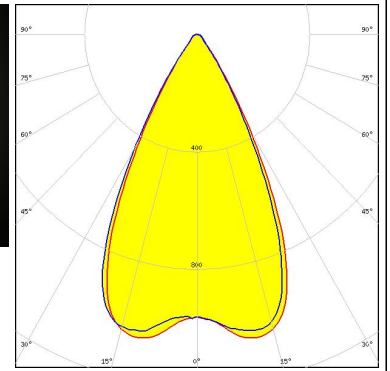

LUMINUS

LED CXM-3
 Ordering code CP18726_YASMEEN-50-WW-C2
 FWHM / FWTM 55.0° / 75.0°
 Efficiency 84 %
 Peak intensity 1.1 cd/lm
 LEDs/each optic 1
 Light colour White
 Required components:
 F17435_HEKLA-G2-C

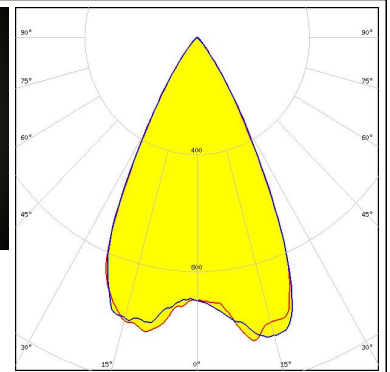

LUMINUS

LED CXM-3
 Ordering code CP18740_YASMEEN-50-WW-C2-WHT
 FWHM / FWTM 55.0° / 76.0°
 Efficiency 92 %
 Peak intensity 1.1 cd/lm
 LEDs/each optic 1
 Light colour White
 Required components:
 F17435_HEKLA-G2-C

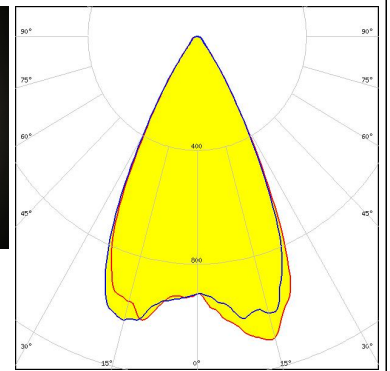

OPTICAL RESULTS (MEASURED):



LED CXM-4
Ordering code CP18740_YASMEEN-50-WW-C2-WHT
FWHM / FWTM 55.0° / 77.0°
Efficiency 92 %
Peak intensity 1.1 cd/lm
LEDs/each optic 1
Light colour White
Required components:
 F17435_HEKLA-G2-C

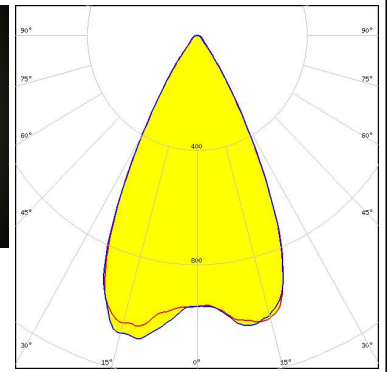
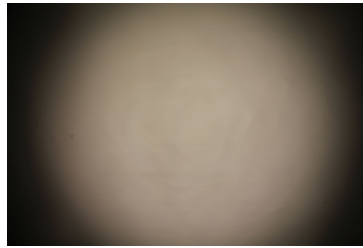

LED CXM-4
Ordering code CP18726_YASMEEN-50-WW-C2
FWHM / FWTM 55.0° / 75.0°
Efficiency 84 %
Peak intensity 1.1 cd/lm
LEDs/each optic 1
Light colour White
Required components:
 F17435_HEKLA-G2-C

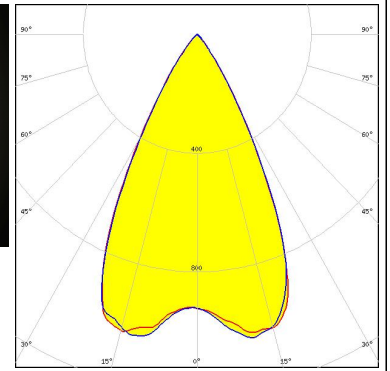

LED COB L-Type (LES 9)
Ordering code CP18740_YASMEEN-50-WW-C2-WHT
FWHM / FWTM 55.0° / 78.0°
Efficiency 91 %
Peak intensity 1.1 cd/lm
LEDs/each optic 1
Light colour White
Required components:
 F17437_HEKLA-G2-H

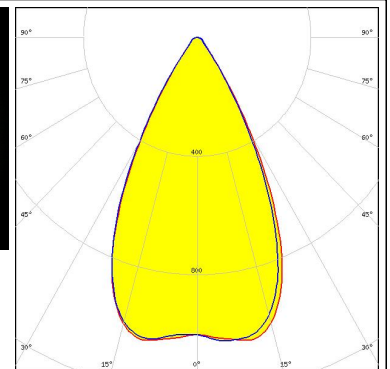
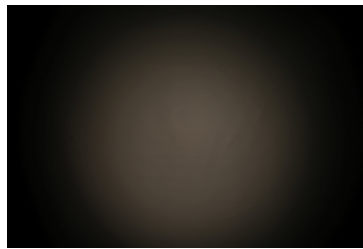

LED COB S-Type (LES 7)
Ordering code CP18740_YASMEEN-50-WW-C2-WHT
FWHM / FWTM 55.0° / 77.0°
Efficiency 90 %
Peak intensity 1 cd/lm
LEDs/each optic 1
Light colour White
Required components:
 F15848_HEKLA-SOCKET-G

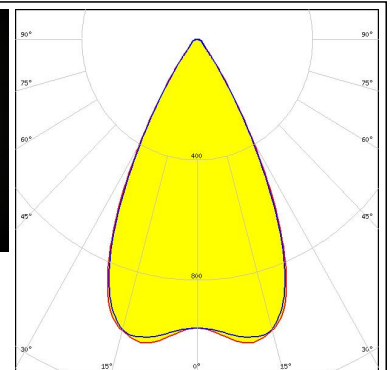
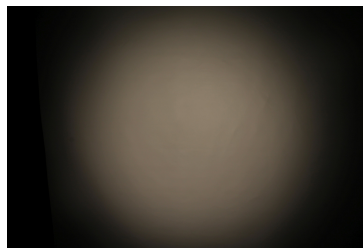

OPTICAL RESULTS (MEASURED):

PHILIPS

LED Fortimo SLM L09 CoB
Ordering code CP18726_YASMEEN-50-WW-C2
FWHM / FWTM 54.0° / 75.0°
Efficiency 83 %
Peak intensity 1.1 cd/lm
LEDs/each optic 1
Light colour White
Required components:
F17437_HEKLA-G2-H

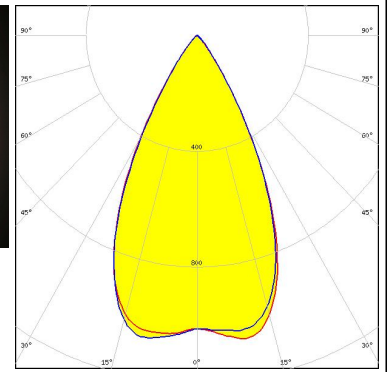

PHILIPS

LED Fortimo SLM L09 CoB
Ordering code CP18740_YASMEEN-50-WW-C2-WHT
FWHM / FWTM 54.0° / 77.0°
Efficiency 92 %
Peak intensity 1.1 cd/lm
LEDs/each optic 1
Light colour White
Required components:
F17437_HEKLA-G2-H

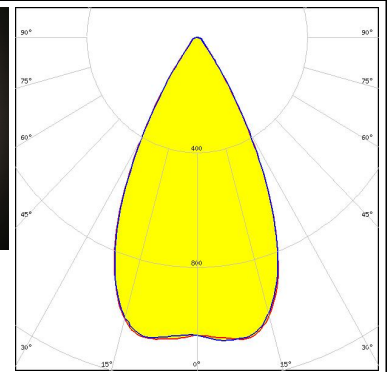

SAMSUNG

LED LC003D / LC006D / LC009D / LC013D
Ordering code CP18726_YASMEEN-50-WW-C2
FWHM / FWTM 54.0° / 76.0°
Efficiency 83 %
Peak intensity 1.1 cd/lm
LEDs/each optic 1
Light colour White
Required components:
F17435_HEKLA-G2-C

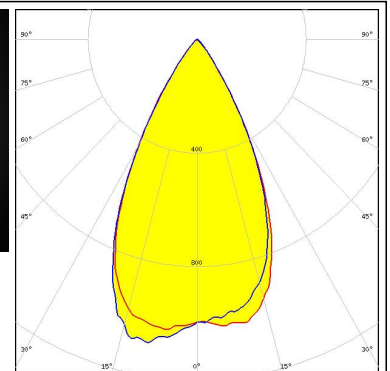
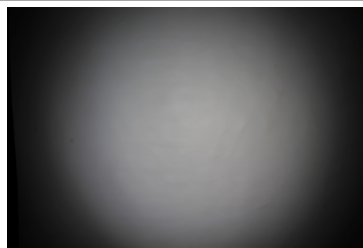

SAMSUNG

LED LC003D / LC006D / LC009D / LC013D
Ordering code CP18740_YASMEEN-50-WW-C2-WHT
FWHM / FWTM 54.0° / 78.0°
Efficiency 91 %
Peak intensity 1.1 cd/lm
LEDs/each optic 1
Light colour White
Required components:
F17435_HEKLA-G2-C

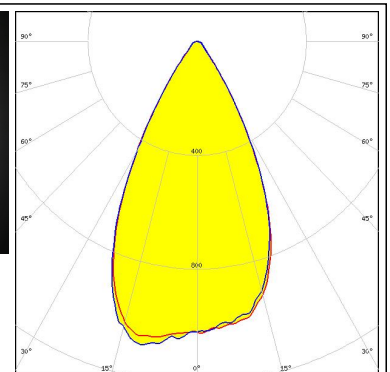
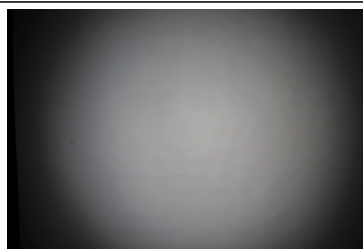

OPTICAL RESULTS (MEASURED):



OPTICAL RESULTS (SIMULATED):

bridgelux

LED Vero SE 13
Ordering code CP18726_YASMEEN-50-WW-C2
FWHM / FWTM 44.0° / 69.0°
Efficiency 77 %
Peak intensity 1.4 cd/lm
LEDs/each optic 1
Light colour White
Required components:
C16142_HEKLA-SOCKET-K

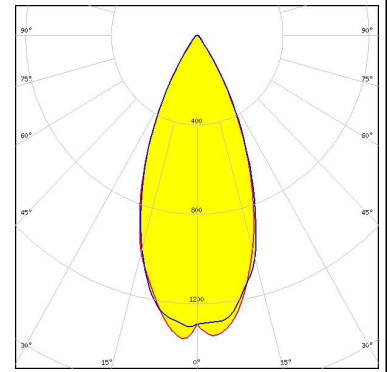

CITIZEN

LED CLL02x/CLU02x (LES10)
Ordering code CP18733_YASMEEN-50-WW-B2
FWHM / FWTM 60.0° / 78.0°
Efficiency 85 %
Peak intensity 1 cd/lm
LEDs/each optic 1
Light colour White
Required components:
BJB: 47.360.1020

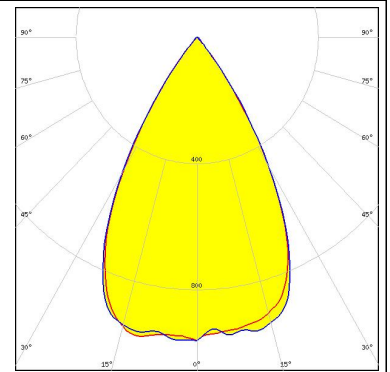

CITIZEN

LED CLL02x/CLU02x (LES10)
Ordering code CP18747_YASMEEN-50-WW-B2-WHT
FWHM / FWTM 60.0° / 80.0°
Efficiency 92 %
Peak intensity 1 cd/lm
LEDs/each optic 1
Light colour White
Required components:
BJB: 47.360.1020

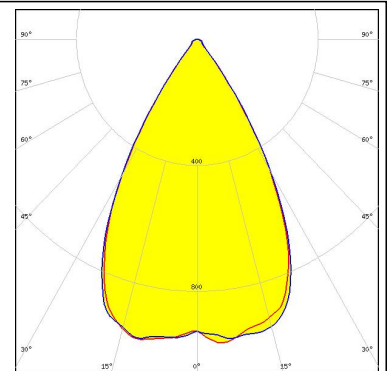

CITIZEN

LED CLU712/713
Ordering code CP18726_YASMEEN-50-WW-C2
FWHM / FWTM 60.0° / 78.0°
Efficiency 86 %
Peak intensity 1 cd/lm
LEDs/each optic 1
Light colour White
Required components:
F17438_HEKLA-G2-I

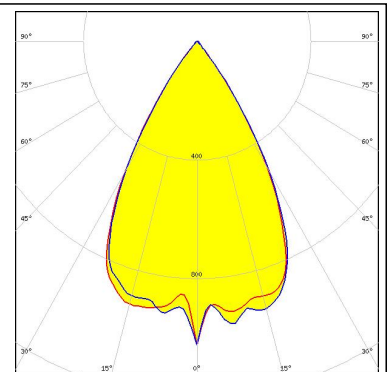

OPTICAL RESULTS (SIMULATED):



LED NVCWJ024Z-V1MT: COB J-Type Tunable White
Ordering code CP18726_YASMEEN-50-WW-C2
FWHM / FWTM 63.0° / 84.0°
Efficiency 81 %
Peak intensity 0.8 cd/lm
LEDs/each optic 1
Light colour White
Required components:
C16142_HEKLA-SOCKET-K
Bender Wirth: 498 Typ L8 HV

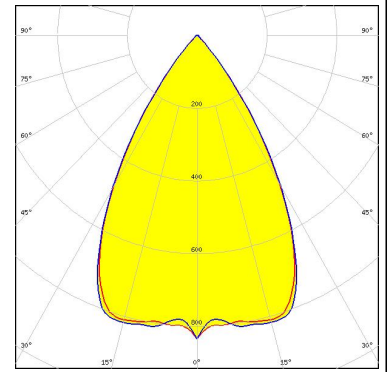

LED Soleriq S15
Ordering code CP18740_YASMEEN-50-WW-C2-WHT
FWHM / FWTM 56.0° / 84.0°
Efficiency 89 %
Peak intensity 1 cd/lm
LEDs/each optic 1
Light colour White
Required components:
F17438_HEKLA-G2-I

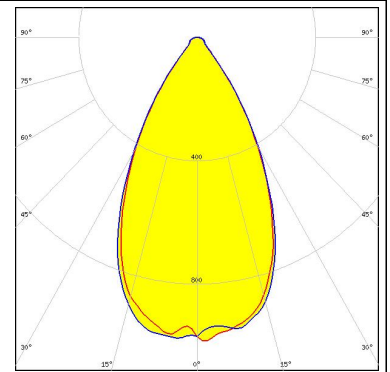

LED SLE G7 LES13
Ordering code CP18726_YASMEEN-50-WW-C2
FWHM / FWTM 56.0° / 80.0°
Efficiency 81 %
Peak intensity 1 cd/lm
LEDs/each optic 1
Light colour White
Required components:
F17438_HEKLA-G2-I

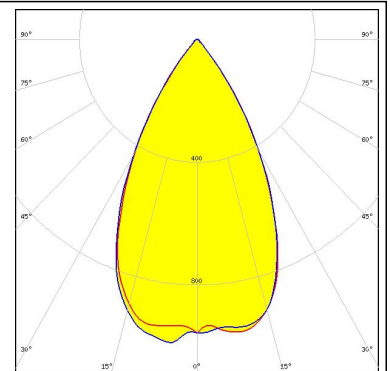

GENERAL INFORMATION:

NOTE: The typical beam angle will be changed by different color, chip size and chip position tolerance. The typical total beam angle is the full angle measured where the luminous intensity is half of the peak value.

Due to use of high power COB's with this product, special attention to proper thermal design is highly recommended. LEDiL has no liability for direct, indirect or consecutive damages arising from the LEDiL products being used outside of the recommended temperature range.

MATERIALS:

As part of our continuous research and improvement processes, and to ensure the best possible quality and availability of our products, LEDiL reserves the right to change material grades without notice.

PRODUCT DATA USER AGREEMENT AND DISCLAIMER:

The measured data in the provided downloadable LEDiL Product Datasheets and Mechanical 2D-Drawings is rounded and provided as reference for planning. LEDiL Oy's optical specifications have been verified by conducting performance testing of the products in accordance with the company's quality system. The reported data are averaged results of multiple measurements with typical variation. LEDiL Oy reserves the right to without prior notification make changes and improvements to its products.

LEDiL Oy assumes neither warranty, nor guarantee nor any other liability of any kind for the contents and correctness of the provided data. The provided data has been generated with highest diligence but the provided data may in reality not represent the complete possible variation range of all intrinsic parameters. Therefore, in certain cases a deviation from the provided data could occur.

LEDiL Oy reserves the right to undertake technical changes of its products without further notification which could lead to changes in the provided data. LEDiL Oy assumes no liability of any kind for the possible deviation from any provided data or any other damage resulting from the usage of the provided data.

The user agrees to this disclaimer and user agreement with the download or usage of the provided files.

LEDiL Oy

Joensuunkatu 13
FI-24240 SALO
Finland

LEDiL Inc.

228 West Page Street
Suite D
Sycamore IL 60178
USA

Ledil Optics Technology (Shenzhen) Co., Ltd.

405 , Block B
Casic Motor Building
Shenzhen 518057
P.R.CHINA

Local sales and technical support

[www.ledil.com/
where_to_buy](http://www.ledil.com/where_to_buy)

Shipping locations

Salo, Finland
Hong Kong, China

Distribution Partners

[www.ledil.com/
where_to_buy](http://www.ledil.com/where_to_buy)

Mouser Electronics

Authorized Distributor

Click to View Pricing, Inventory, Delivery & Lifecycle Information:

[Ledi:](#)

[CP18726_YASMEEN-50-WW-C2](#) [CP18733_YASMEEN-50-WW-B2](#) [CP18740_YASMEEN-50-WW-C2-WHT](#)
[CP18747_YASMEEN-50-WW-B2-WHT](#)