

Description

The P9221-R is a high-efficiency, Qi-compliant wireless power receiver targeted for applications up to 15W. Using magnetic inductive charging technology, the receiver converts an AC power signal from a resonant tank to a programmable regulated 9V or 12V DC output voltage. The integrated, low RDS_{ON} synchronous rectifier and ultra-low dropout linear (LDO) regulator offer high efficiency, making the product ideally suited for battery-operated applications.

The P9221-R includes an industry-leading 32 bit ARM® Cortex®-M0 microprocessor offering a high level of programmability. In addition, the P9221-R features a programmable current limit and a patented over-voltage protection scheme eliminating the need for additional capacitors generally used by receivers and minimizing the external component count and cost. Together with IDT's P9242-R transmitter (Tx), the P9221-R is a complete wireless power system solution for power applications up to 15W.

The P9221-R is available in a 52-WLCSP package, and it is rated for a 0 to 85°C ambient operating temperature range.

Typical Applications

- Mobile phones
- Tablets
- Accessories
- Medical

Features

- Single-chip solution supporting up to 15W applications
- WPC-1.2.3 compliant
- Patented over-voltage protection clamp eliminating external capacitors
- 87% peak DC-to-DC efficiency with P9242-R Tx
- Full synchronous rectifier with low RDS_{ON} switches
- Programmable output voltage: 9V or 12V
- User-programmable foreign-object detection (FOD)
- Embedded 32-bit ARM® Cortex®-M0 processor
- Dedicated remote temperature sensing
- Power transfer LED indicator
- Programmable current limit
- Active-low enable pin for electrical on/off
- Open-drain interrupt flag
- Supports I²C interface
- 0 to +85°C ambient operating temperature range
- 52-WLCSP (2.64 × 3.94 mm; 0.4mm pitch)

Typical Application Circuit

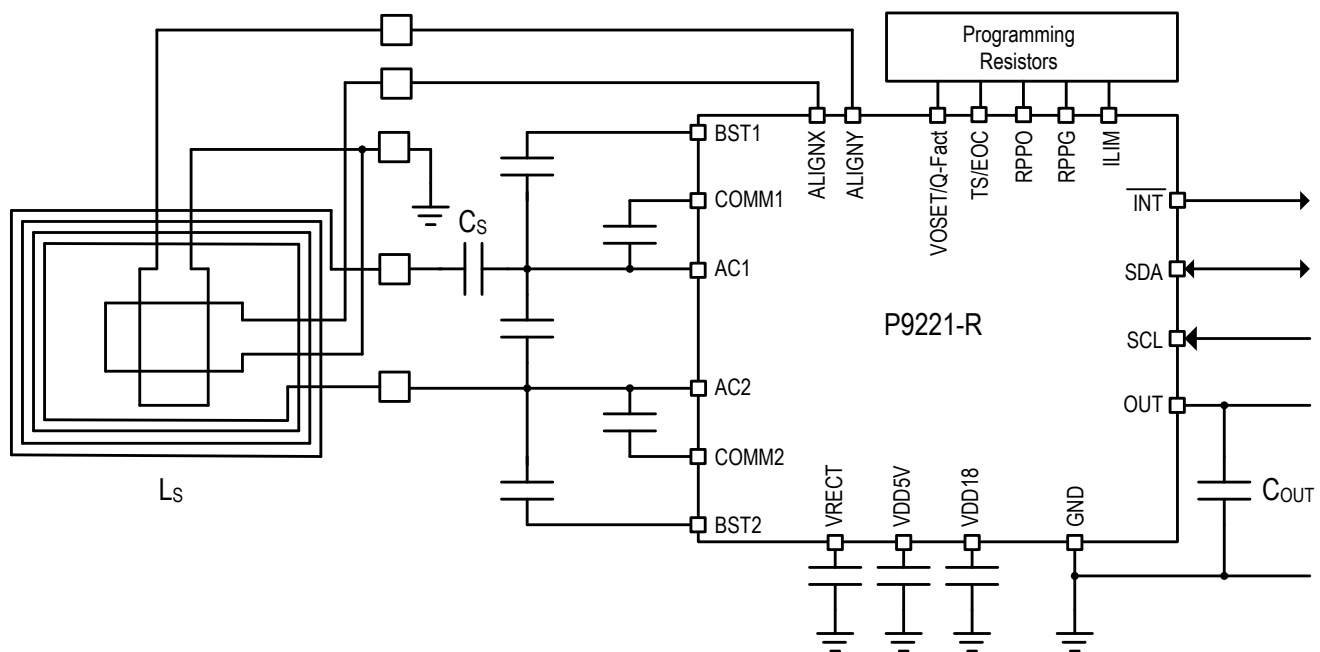

Contents

1.	Pin Assignments	5
2.	Pin Descriptions	6
3.	Absolute Maximum Ratings	8
4.	Thermal Characteristics	9
5.	Electrical Characteristics	9
6.	Typical Performance Characteristics	12
7.	Functional Block Diagram	15
8.	Theory of Operation	16
8.1	LDO – Low Dropout Regulators	16
8.2	Setting the Output Voltage and Reference Q-factor Value – VOSET/Q-Fact Pin	16
8.3	SINK Pin	17
8.4	Rectifier Voltage – VRECT	17
8.5	Over-Current Limit – ILIM	17
8.6	Interrupt Function – INT	18
8.7	Enable Pin – EN	18
8.8	Thermal Protection	18
8.9	External Temperature Sensing and End of Charge – TS/EOC	18
8.10	Alignment Guide – ALIGNX and ALIGNY	18
8.11	Advanced Foreign Object Detection (FOD)	19
8.12	Received Power Packet Offset and Gain Calibration – RPPO and RPPG	20
9.	Communication Interface	21
9.1	Modulation/Communication	21
9.2	Bit Encoding Scheme for ASK	22
9.3	Byte Encoding for ASK	22
9.4	Packet Structure	22
10.	WPC Mode Characteristics	23
10.1	Selection Phase or Startup	23
10.2	Ping Phase (Digital Ping)	23
10.3	Identification and Configuration Phase	24
10.4	Negotiation Phase	24
10.5	Calibration Phase	24
10.6	Power Transfer Phase	24
11.	Functional Registers	25
12.	Application Information	29
12.1	Power Dissipation and Thermal Requirements	29
12.2	Recommended Coils	30
12.3	Typical Application Schematic	31
12.4	Bill of Materials (BOM)	32

13. Package Drawings.....	34
14. Recommended Land Pattern.....	35
15. Special Notes: WLCSP-52 (AHG52) Package Assembly.....	36
16. Marking Diagram	36
17. Ordering Information.....	36
18. Revision History.....	37

List of Figures

Figure 1. Pin Assignments.....	5
Figure 2. Efficiency vs. Output Load: $V_{OUT} = 12V$	12
Figure 3. Load Reg. vs. Output Load: $V_{OUT} = 12V$	12
Figure 4. Efficiency vs. Output Load: $V_{OUT} = 9V$	12
Figure 5. Load Reg. vs. Output Load: $V_{OUT} = 9V$	12
Figure 6. Efficiency vs. Output Load: $V_{OUT} = 5V$	12
Figure 7. Load Reg. vs. Output Load: $V_{OUT} = 5V$	12
Figure 8. Rectifier Voltage vs. Load: $V_{OUT} = 12V$	13
Figure 9. Rectifier Voltage vs. Load: $V_{OUT} = 9V$	13
Figure 10. Rectifier Voltage vs. Load: $V_{OUT} = 5V$	13
Figure 11. Current Limit vs. V_{LIM}	13
Figure 12. X and Y Misalignment.....	13
Figure 13. Max. Power vs. Misalignment: $V_{OUT}=12V$	13
Figure 14. Enable Startup: $V_{OUT} = 12V$; $I_{OUT} = 1.2A$	14
Figure 15. Transient Resp: $V_{OUT} = 12V$; $I_{OUT} = 0$ to $1.2A$	14
Figure 16. Transient Resp: $V_{OUT} = 12V$; $I_{OUT} = 1.3A$ to 0	14
Figure 17. Functional Block Diagram.....	15
Figure 18. Example of Differential Bi-phase Decoding for FSK.....	21
Figure 19. Example of Asynchronous Serial Byte Format for FSK.....	21
Figure 20. Bit Encoding Scheme	22
Figure 21. Byte Encoding Scheme	22
Figure 22. Communication Packet Structure	22
Figure 23. WPC Power Transfer Phases Flowchart	23
Figure 24. Typical Application Schematic – P9221-R Evaluation Board Revision 2.2.....	31
Figure 25. Package Outline Drawing (AHG52).....	34
Figure 26. 52-WLCSP (AHG52) Land Pattern.....	35

List of Tables

Table 1.	Pin Descriptions.....	6
Table 2.	Absolute Maximum Ratings.....	8
Table 3.	ESD Information.....	8
Table 4.	Package Thermal Information.....	9
Table 5.	Electrical Characteristics.....	9
Table 6.	Setting the Output Voltage and Reference Q-factor Value.....	17
Table 7.	Setting the Over Current Limit.....	17
Table 8.	Maximum Estimated Power Loss.....	19
Table 9.	Device Identification Register.....	25
Table 10.	Firmware Major Revision.....	25
Table 11.	Firmware Minor Revision.....	25
Table 12.	Status Registers.....	25
Table 13.	Interrupt Status Registers.....	26
Table 14.	Interrupt Enable Registers.....	26
Table 15.	Battery Charge Status.....	27
Table 16.	End Power Transfer.....	27
Table 17.	Read Register – Output Voltage.....	27
Table 18.	Read Register – VRECT Voltage.....	27
Table 19.	Read Register – IOOUT Current.....	27
Table 20.	Read Register – Die Temperature.....	28
Table 21.	Read Register – Operating Frequency.....	28
Table 22.	Alignment X Value Register.....	28
Table 23.	Alignment Y Value Register.....	28
Table 24.	Command Register.....	29
Table 25.	Recommended Coil Manufacturers.....	30
Table 26.	P9221-R MM Evaluation Kit V2.2 Bill of Materials.....	32

1. Pin Assignments

Figure 1. Pin Assignments

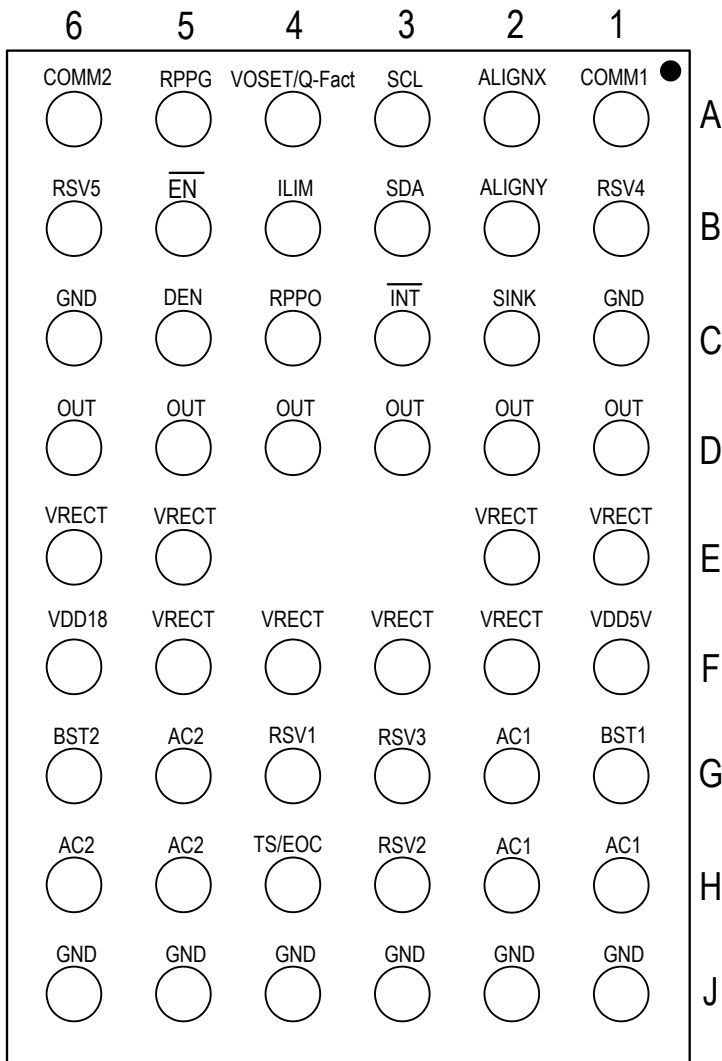

Bottom View

2. Pin Descriptions

Table 1. Pin Descriptions

Pins	Name	Type	Function
A1	COMM1	Output	Open-drain output used to communicate with the transmitter. Connect a 47nF capacitor from AC1 to COMM1.
A2	ALIGNX	Input	AC input for coil alignment guide. If not used, connect this pin to GND through a 10kΩ resistor.
A3	SCL	Input	Serial clock line. Open-drain pin. Connect this pin to a 5.1kΩ resistor to the VDD18 pin.
A4	VOSET/ Q-Fact	Input	Programming pin for setting the output voltage and Q-factor. For VOSET, connect this pin to the center tap of a resistor divider to set the output voltage. For more information, refer to section 8.2 for different output voltage settings and section 8.2 for adjusting the Q-factor value.
A5	RPPG	Input	Received power packet gain (RPPG) calibration pin for foreign object detection (FOD) tuning. Connect this pin to the center tap of a resistor divider to set the gain of the FOD. The FOD is disabled by connecting the RPPG and RPPO pins to GND. Do not leave this pin floating.
A6	COMM2	Output	Open-drain output used to communicate with the transmitter. Connect a 47nF capacitor from AC2 to COMM2.
B1	RSV4	–	Reserved for internal use. Do not connect.
B2	ALIGNY	Input	AC input for coil alignment guide. If not used, connect to GND through a 10kΩ resistor.
B3	SDA	Input/Output	Serial data line. Open-drain pin. Connect a 5.1kΩ resistor to VDD18 pin.
B4	ILIM	Input	Programmable over-current limit pin. Connect this pin to the center tap of a resistor divider to set the current limit. For more information about the current limit function, see section 8.5.
B5	$\overline{\text{EN}}$	Input	Active-LOW enable pin. Pulling this pin to logic HIGH forces the device into Shut Down Mode. When connected to logic LOW, the device is enabled. Do not leave this pin floating.
B6	RSV5	–	Reserved for internal use. Do not connect.
C1, C6, J1, J2, J3, J4, J5, J6	GND	GND	Ground.
C2	SINK	Output	Open-drain output for controlling the rectifier clamp. Connect a 36Ω resistor from this pin to the VRECT pin.
C3	$\overline{\text{INT}}$	Output	Interrupt flag pin. This is an open-drain output that signals fault interrupts. It is pulled LOW if any of these faults exist: an over-voltage is detected, an over-current condition is detected, the die temperature exceeds 140°C, or an external over-temperature condition is detected on the TS pin. It is also asserted LOW when $\overline{\text{EN}}$ is HIGH. Connect $\overline{\text{INT}}$ to VDD18 through a 10kΩ resistor. See section 8.6 for additional conditions affecting the interrupt flag.
C4	RPPO	Input	Received power packet offset (RPPO) calibration pin for FOD tuning. Connect this pin to the center tap of the resistor divider to set the offset of the FOD. The FOD is disabled by connecting the RPPG and RPPO pins to GND. Do not leave this pin floating.

Pins	Name	Type	Function
C5	DEN	Input	Reserved. This pin must be connected to a 10kΩ resistor to the VDD18 pin.
D1, D2, D3, D4, D5, D6	OUT	Output	Regulated output voltage pin. Connect two 10μF capacitors from this pin to GND. The default voltage is set to 12V when the VOSET pin is pulled up to the VDD18 pin through a 10kΩ resistor. For more information about VOSET, see section 8.2.
E1, E2, E5, E6, F2, F3, F4, F5	VRECT	Output	Output voltage of the synchronous rectifier bridge. Connect three 10μF capacitors and a 0.1μF capacitor in parallel to GND. The rectifier voltage dynamically changes as the load changes. For more information, see the typical waveforms in section 6.
F1	VDD5V	Output	Internal 5V regulator output voltage for internal use. Connect a 1μF capacitor from this pin to ground. Do not load the pin.
F6	VDD18	Output	Internal 1.8V regulator output voltage. Connect a 1μF capacitor from this pin to ground. Do not load the pin.
G1	BST1	Output	Boost capacitor for driving the high-side switch of the internal rectifier. Connect a 15nF capacitor from the AC1 pin to BST1.
G2, H1, H2,	AC1	Input	AC input power. Connect these pins to the resonant capacitance C _S (C1, C2, C3, and C5 in Figure 24).
G3	RSV3	Input	Reserved pins. This pin must be connected to the OUT pin. Do not leave this pin floating.
G4	RSV1	–	Reserved for internal use. Do not connect.
G5, H5, H6	AC2	Input	AC input power. Connect to the Rx coil (L1 in Figure 24).
G6	BST2	Output	Boost capacitor for driving the high-side switch of the internal rectifier. Connect a 15nF capacitor from the AC2 pin to BST2.
H3	RSV2	–	Reserved pins. This pin must be connected to the OUT pin. Do not leave this pin floating.
H4	TS/EOC	Input	End of Charge (EOC) and remote temperature (TS) sensing for over-temperature shutdown. For remote temperature sensing, connect to the NTC thermistor network. If not used, connect this pin to the VDD18 pin through the 10kΩ resistor. For EOC, connecting this pin to ground will send the End Power Transfer (EPT) packet to the transmitter to terminate the power. For more information, refer to section 8.9.

3. Absolute Maximum Ratings

Stresses greater than those listed as absolute maximum ratings in Table 2 could cause permanent damage to the device. These are stress ratings only, and functional operation of the device at these or any other conditions above those indicated in the operational sections of this specification is not implied. Exposure to absolute maximum rating conditions for extended periods might affect reliability.

Table 2. Absolute Maximum Ratings

Pins [a],[b]	Parameter	Conditions	Minimum [c]	Maximum [c]	Units
AC1 [d], AC2 [d], COMM1, COMM2	Absolute Maximum Pin Voltage		-0.3	20	V
$\overline{\text{EN}}$	Absolute Maximum Pin Voltage		-0.3	28	V
SINK, VRECT	Absolute Maximum Pin Voltage		-0.3	24	V
DEN, ILIM, RPPG, RPPO, VDD18, VOSET	Absolute Maximum Pin Voltage		-0.3	2	V
ALIGNX, ALIGNY, $\overline{\text{INT}}$, SCL, SDA, TS, VDD5V	Absolute Maximum Pin Voltage		-0.3	6	V
BST1	Absolute Maximum Pin Voltage		-0.3	AC1 + 6	V
BST2	Absolute Maximum Pin Voltage		-0.3	AC2 + 6	V
OUT	Absolute Maximum Pin Voltage		-0.3	14.4	V
SINK	Maximum Current on Pin		–	1	A
COMM1, COMM2	Maximum RMS Current on Pin		–	500	mA
AC1, AC2	Maximum RMS Current from Pin		–	2	A

[a] Absolute maximum ratings are not provided for reserved pins (RSV1, RSV2, RSV3, RSV4, RSV5, and DEN). These pins are not used in the application.

[b] For the test conditions for the absolute maximum ratings specifications, the P9221-R characterization for the operating ambient temperature (T_{AMB}) specification (see Table 4) has been performed down to -10°C only. Design simulation indicates normal operation down to -45°C . Limited bench functionality tests indicate normal operation down to -40°C .

[c] All voltages are referred to ground unless otherwise noted.

[d] During synchronous rectifier dead time, the voltage on the AC1 and AC2 pins is developed by current across the internal power FET's body diodes, and it might be lower than -0.3 V . This is a normal behavior and does not negatively impact the functionality or reliability of the product.

Table 3. ESD Information

Test Model	Pins	Ratings	Units
HBM	All pins except RSV1, RSV2, RSV3, RSV4, and RSV5 pins	2	kV
	RSV1, RSV2, RSV3, RSV4, and RSV5 pins	1	kV
CDM	All pins	500	V

4. Thermal Characteristics

Table 4. Package Thermal Information

Note: This thermal rating was calculated on a JEDEC 51 standard 4-layer board with dimensions 76.2 x 114.3 mm in still air conditions.

Symbol	Description	WLCSP Rating 8 Thermal Balls	Units
θ_{JA}	Thermal Resistance Junction to Ambient ^[a]	47	°C/W
θ_{JC}	Thermal Resistance Junction to Case	0.202	°C/W
θ_{JB}	Thermal Resistance Junction to Board	4.36	°C/W
T_J	Operating Junction Temperature ^[a]	-5 to +125	°C
T_{AMB}	Ambient Operating Temperature ^[a]	0 to +85	°C
T_{STOR}	Storage Temperature	-55 to +150	°C
T_{BUMP}	Maximum Soldering Temperature (Reflow, Pb-Free)	260	°C

[a] The maximum power dissipation is $P_{D(MAX)} = (T_{J(MAX)} - T_{AMB}) / \theta_{JA}$ where $T_{J(MAX)}$ is 125°C. Exceeding the maximum allowable power dissipation will result in excessive die temperature, and the device will enter thermal shutdown.

5. Electrical Characteristics

Table 5. Electrical Characteristics

Note: $V_{RECT} = 5.5V$; $C_{OUT} = 4.7\mu F$, $\overline{EN} = LOW$, unless otherwise noted. $T_J = 0^\circ C$ to $125^\circ C$; typical values are at $25^\circ C$.

Note: See important notes at the end of this table.

Symbol	Description	Conditions	Min	Typical	Max	Units
Under-Voltage Lock-Out (UVLO)						
V_{UVLO_Rising}	UVLO Rising	Rising voltage on VRECT		2.9	2.98	V
V_{UVLO_HYS}	UVLO Hysteresis	VRECT falling		200		mV
Over-Voltage Protection						
V_{OVP_DC}	DC Over-Voltage Protection	Rising voltage on VRECT		17		V
V_{OVP_HYS}	Over-Voltage Hysteresis			1		V
Quiescent Current						
I_{ACTIVE_SUPPLY}	Supply Current	$\overline{EN} = Low$, No load; $V_{RECT} = 12.3V$		3.0		mA
I_{SHD}	Shut Down Mode Current	$\overline{EN} = High$; $V_{RECT} = 12.3V$		500		μA
VDD18 Voltage						
V_{VDD18}	VDD18 Pin Output Voltage ^[a]	$I_{VDD18} = 10mA$, $C_{VDD18} = 1\mu F$	1.62	1.8	1.98	V

Symbol	Description	Conditions	Min	Typical	Max	Units
VDD5V Voltage						
V _{VDD5V}	VDD5V Pin Output Voltage ^[a]	I _{VDD5V} = 10mA, C _{VDD5V} = 1μF	4.5	5	5.5	V
Low Drop-Out (LDO) Regulator						
I _{OUT_MAX}	Maximum Output Current			1.25		A
V _{OUT_12V}	12V Output Voltage	VOSET > 1.5V, VRECT=12.3V		12		V
V _{OUT_9V}	9V Output Voltage	0.7V < VOSET < 1.2V, VRECT=9.3V		9		V
Analog to Digital Converter						
N	Resolution			12		Bit
f _{SAMPLE}	Sampling Rate			67.5		kSa/s
Channel	Number of Channels			8		
V _{IN,FS}	Full-Scale Input Voltage			2.1		V
EN pin						
V _{IH_EN}	Input Threshold HIGH		1.4			V
V _{IL_EN}	Input Threshold LOW				0.25	V
I _{IL_EN}	Input Current LOW	V _{EN} = 0V	-1		1	μA
I _{IH_EN}	Input Current HIGH	V _{EN} = 5V		2.5		μA
VOSET, ILIM, TS, RPPO, RPPG						
I _{IL}	Input Current LOW	V _{VOSET} , V _{ILIM} , V _{TS} , V _{RPPO} , V _{RPPG} = 0V	-1		1	μA
I _{IH}	Input Current HIGH	V _{VOSET} , V _{ILIM} , V _{TS} , V _{RPPO} , V _{RPPG} = 1.8V	-1		1	μA
ALIGNX, ALIGNY and INT pins						
I _{LKG}	Input Leakage Current	V _{ALIGNX} , V _{ALIGNY} , V _{INT} = 0V and 5V	-1		1	μA
V _{OL}	Output Logic LOW	I _{OL} = 8mA			0.36	V
I²C Interface – SCL, SDA						
V _{IL}	Input Threshold LOW				0.7	V
V _{IH}	Input Threshold HIGH		1.4			V
I _{LKG}	Input Leakage Current	V _{SCL} , V _{SDA} = 0V and 5V	-1		1	μA
V _{OL}	Output Logic LOW	I _{OL} = 8mA			0.36	V
f _{SCL}	Clock Frequency				400	kHz
t _{HD,STA}	Hold Time (Repeated) for START Condition		0.6			μs
t _{HD:DAT}	Data Hold Time		0			ns
t _{LOW}	Clock Low Period		1.3			μs
t _{HIGH}	Clock High Period		0.6			μs

Symbol	Description	Conditions	Min	Typical	Max	Units
$t_{SU:STA}$	Set-up Time for Repeated START Condition		0.6			μs
t_{BUF}	Bus Free Time Between STOP and START Condition		1.3			μs
C_B	Capacitive Load for SCL and SDA			150		pF
C_I	SCL, SDA Input Capacitance			5		pF
Thermal Shutdown						
T_{SD}	Thermal Shutdown	Rising ^[b]		140		$^{\circ}C$
		Falling		120		$^{\circ}C$

[a] Do not externally load. For internal biasing only.

[b] If the die temperature exceeds 130 $^{\circ}C$, the *Thermal_SHTDN_Status* flag is set and an End Power Transfer (EPT) packet is sent (see Table 12).

6. Typical Performance Characteristics

The following performance characteristics were taken using a P9242-R, 15W wireless power transmitter at $T_{AMB} = 25^{\circ}\text{C}$ unless otherwise noted.

Figure 2. Efficiency vs. Output Load: $V_{OUT} = 12\text{V}$

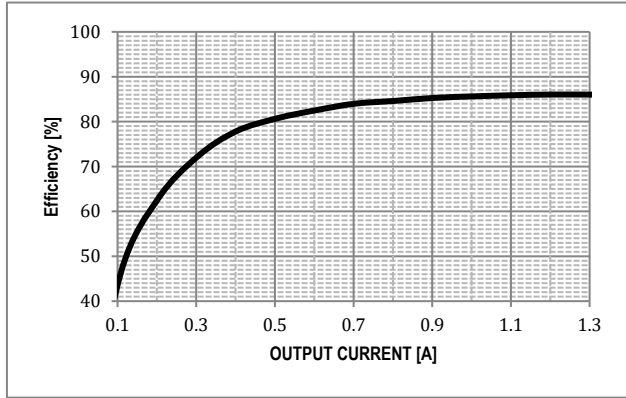

Figure 3. Load Reg. vs. Output Load: $V_{OUT} = 12\text{V}$

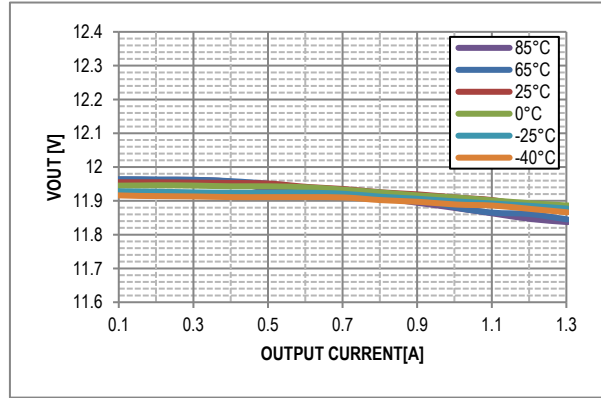

Figure 4. Efficiency vs. Output Load: $V_{OUT} = 9\text{V}$

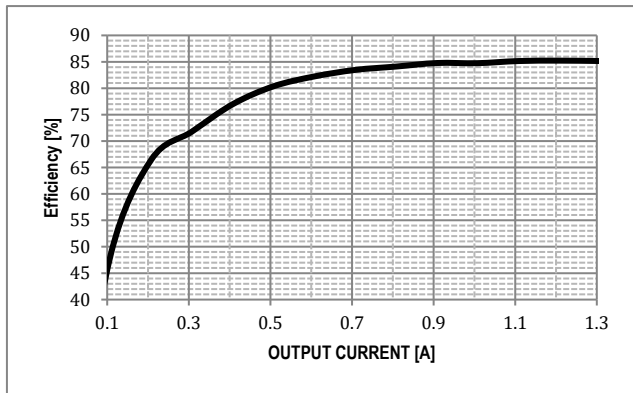

Figure 5. Load Reg. vs. Output Load: $V_{OUT} = 9\text{V}$

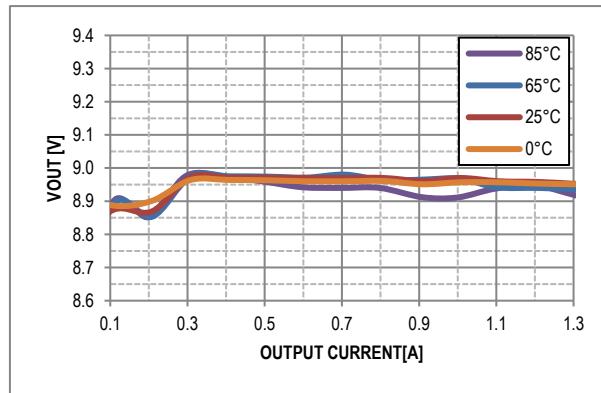

Figure 6. Efficiency vs. Output Load: $V_{OUT} = 5\text{V}$

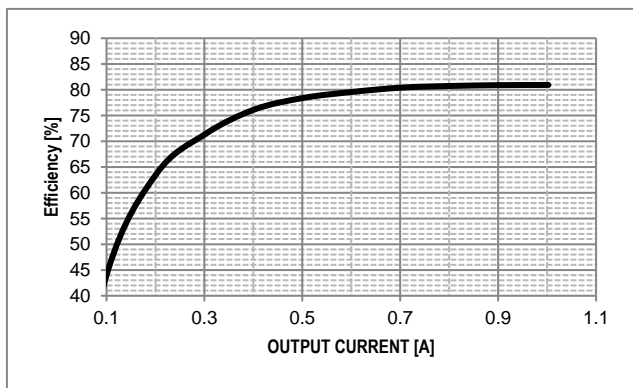

Figure 7. Load Reg. vs. Output Load: $V_{OUT} = 5\text{V}$

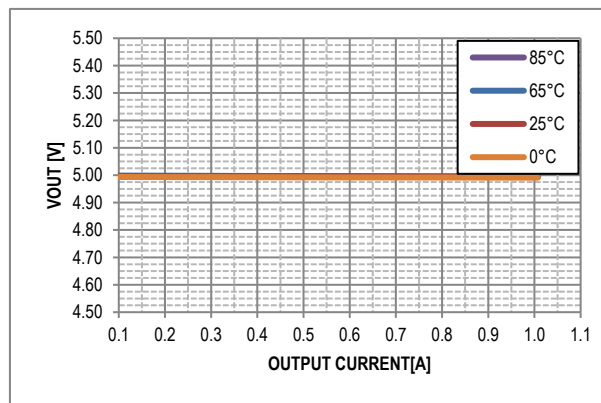

Figure 8. Rectifier Voltage vs. Load: $V_{OUT} = 12V$

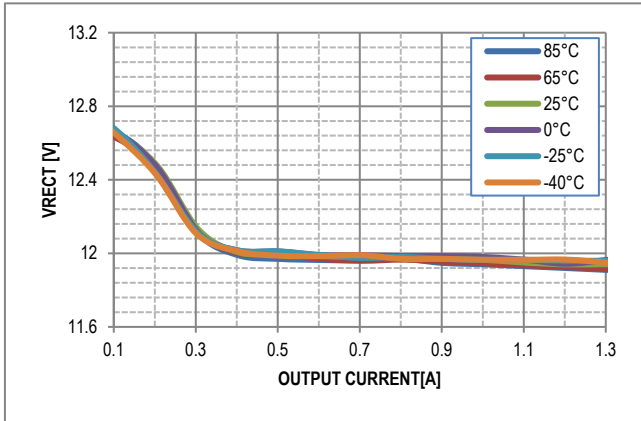

Figure 9. Rectifier Voltage vs. Load: $V_{OUT} = 9V$

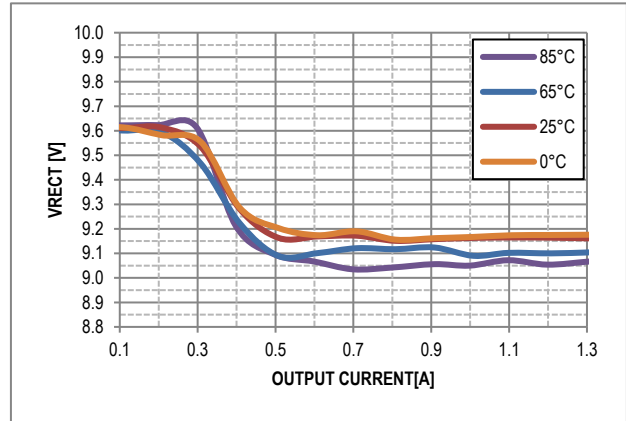

Figure 10. Rectifier Voltage vs. Load: $V_{OUT} = 5V$

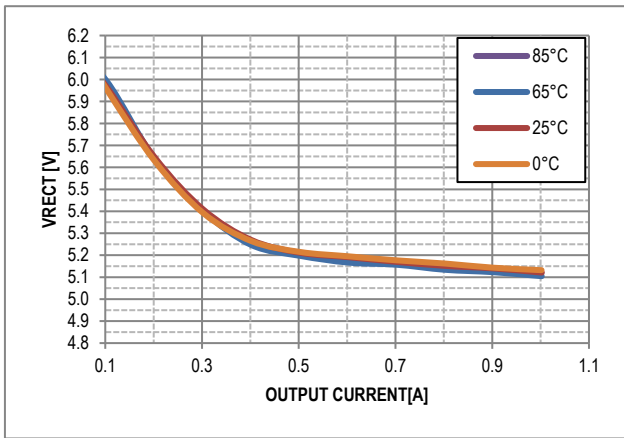

Figure 11. Current Limit vs. V_{ILIM}

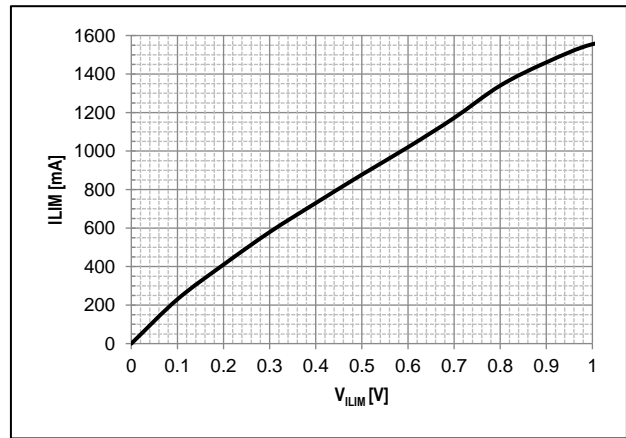

Figure 12. X and Y Misalignment

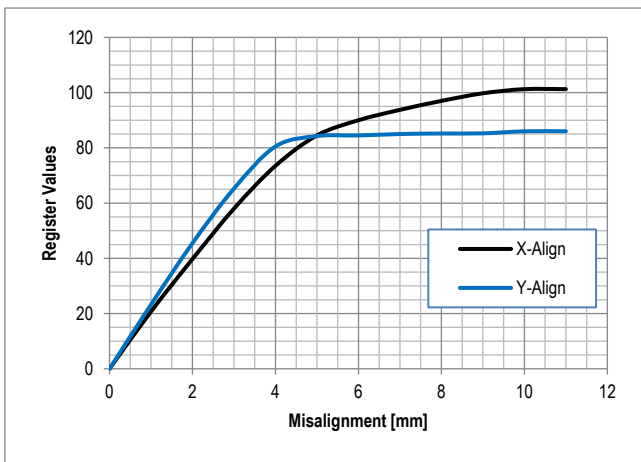

Figure 13. Max. Power vs. Misalignment: $V_{OUT}=12V$

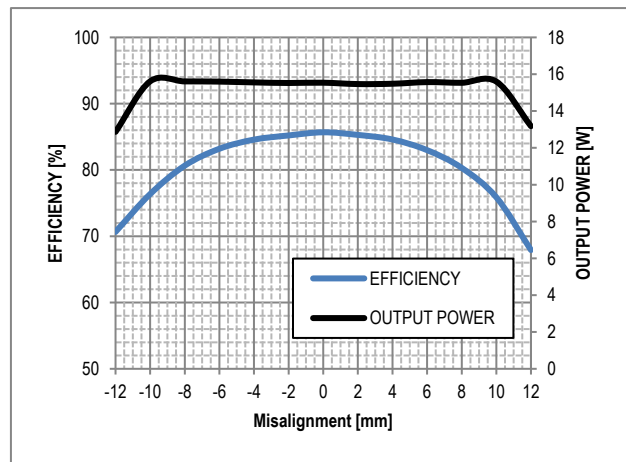

Figure 14. Enable Startup: $V_{OUT} = 12V$; $I_{OUT} = 1.2A$

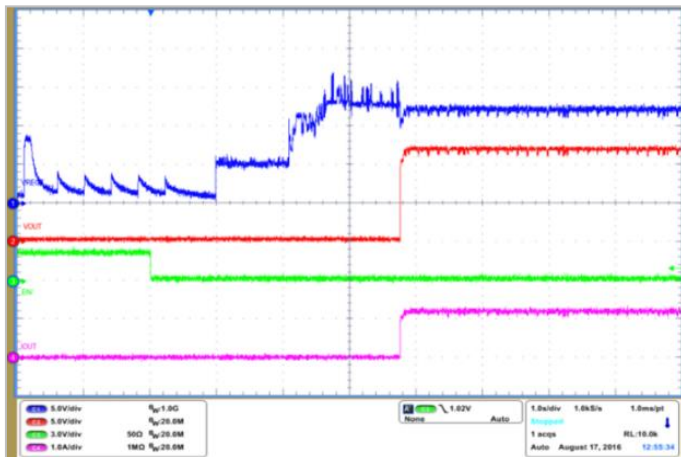

Figure 15. Transient Resp: $V_{OUT} = 12V$; $I_{OUT} = 0$ to 1.2A

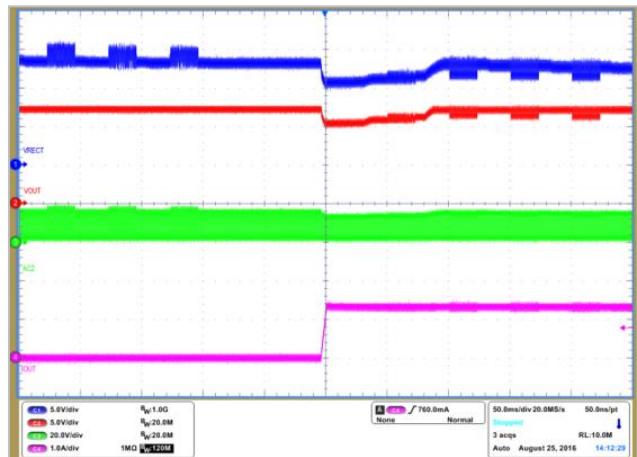
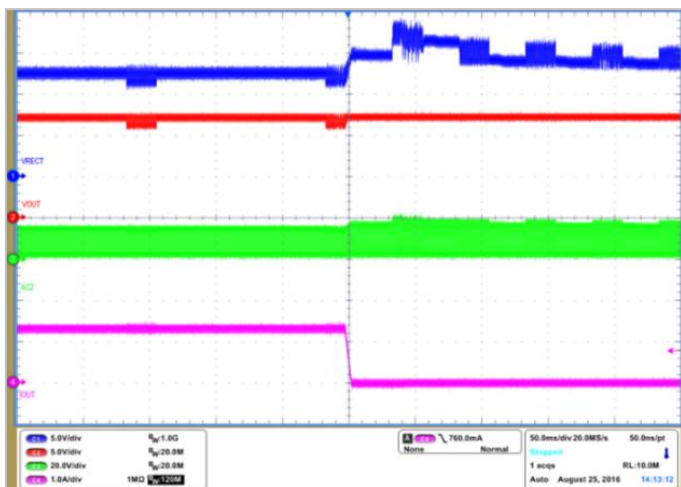
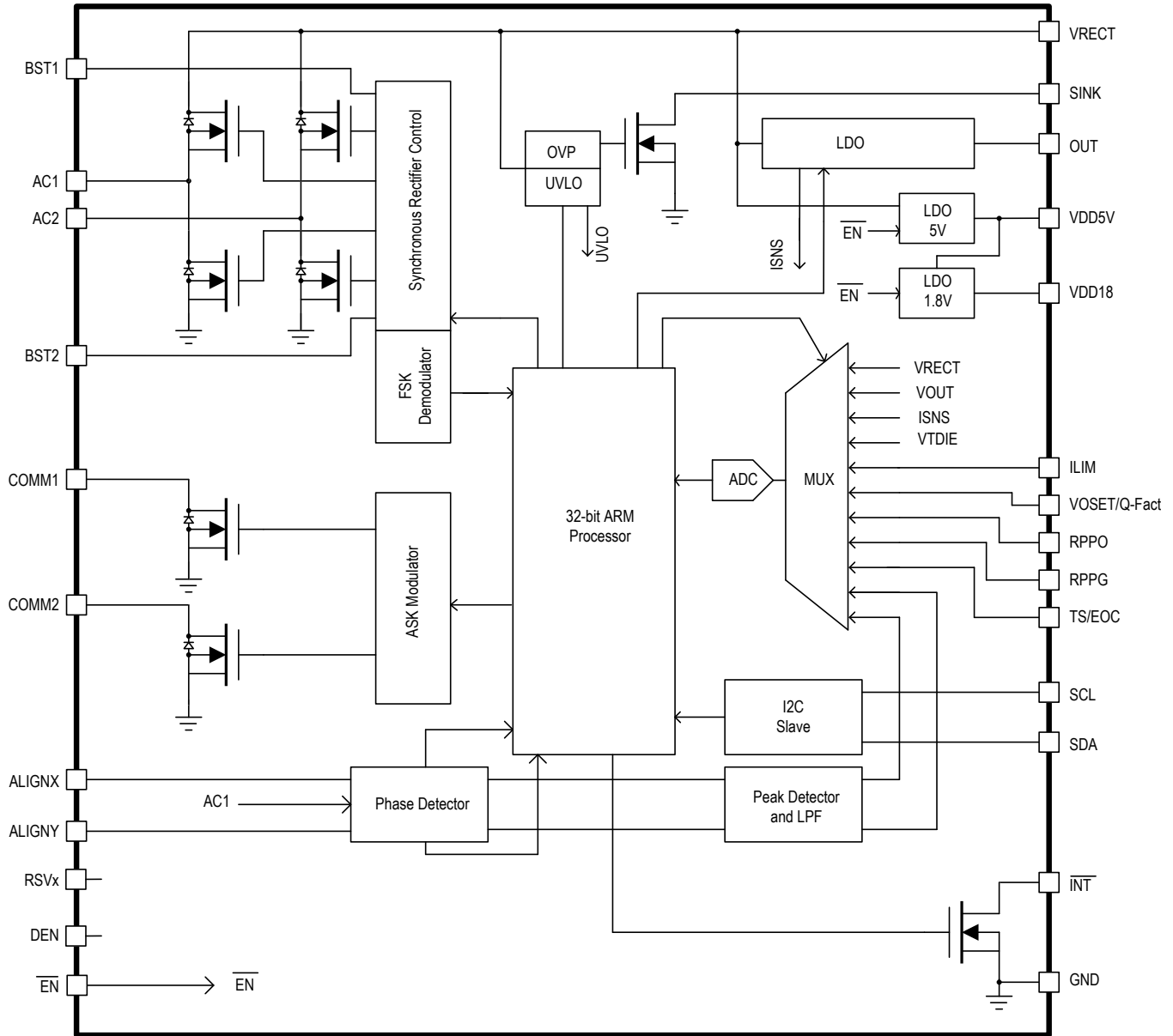

Figure 16. Transient Resp: $V_{OUT} = 12V$; $I_{OUT} = 1.3A$ to 0



7. Functional Block Diagram

Figure 17. Functional Block Diagram



8. Theory of Operation

The P9221-R is a highly-integrated, wireless power receiver targeted for 15W applications. The device integrates a full-wave synchronous rectifier, low-dropout (LDO) linear regulator, and a 32-bit ARM®-based M0 microprocessor to manage all the digital control required to comply with the WPC-1.2.3 communication protocol.

Using the near-field inductive power transfer, the receiver converts the AC signal to a DC voltage using the integrated synchronous rectifier. The capacitor connected to the output of the rectifier smooths the full-wave rectified voltage into a DC voltage. After the internal biasing circuit is enabled, the "Synchronous Rectifier Control" block operates the switches of the rectifier in various modes to maintain reliable connections and optimal efficiency.

The rectifier voltage and the output current are sampled periodically and digitized by the analog-to-digital converter (ADC). The digital equivalents of the voltage and current are supplied to the internal control logic, which determines whether the loading conditions on the VRECT pin indicate that a change in the operating point is required. If the load is heavy enough and brings the voltage at VRECT below its target, the transmitter is set to a lower frequency that is closer to resonance and to a higher output power. If the voltage at VRECT is higher than its target, the transmitter is instructed to increase its frequency. To maximize efficiency, the voltage at VRECT is programmed to decrease as the LDO's load current increases. The internal temperature is continuously monitored to ensure proper operation.

In the event that the VRECT voltage increases above 13.5V, the control loop disables the LDO and sends error packets to the transmitter in an attempt to bring the rectifier voltage back to a safe operating voltage level while simultaneously clamping the incoming energy using the open-drain SINK pin for VRECT linear clamping. The clamp is released when the VRECT voltage falls below the V_{OVP-DC} minus $V_{OVP-HYS}$. Refer to Figure 17. The receiver utilizes IDT's proprietary voltage clamping scheme, which limits the maximum voltage at the rectifier pin to 13.5V, reducing the voltage rating on the output capacitors while eliminating the need for over-voltage protection (OVP) capacitors. As a result, it provides a small application area, making it an industry-leading wireless power receiver for high power density applications. Combined with the P9242-R transmitter, the P9221-R is a complete wireless power system solution.

8.1 LDO – Low Dropout Regulators

The P9221-R has three low-dropout linear regulators. The main regulator is used to provide the power required by the battery charger where the output voltage can be set to either 9V or 12V. For more information about setting the output voltage, see section 8.2. It is important to connect a minimum of 30µF ceramic capacitance to the OUT pin.

The other two regulators, VDD5V and VDD18, are to bias the internal circuitry of the receiver. The LDOs must have local 1µF ceramic capacitors placed as close as possible to the pins.

8.2 Setting the Output Voltage and Reference Q-factor Value – VOSET/Q-Fact Pin

The output voltage on the P9221-R is programmed by connecting the center tap of the external resistors R34 and R33 to the VOSET/Q-Fact pin as shown in the application schematic in Figure 24. The output voltage can be set to 9V or 12V. The recommended settings for R33 and R34 are summarized in Table 6.

The default output voltage is set to 12V in the P9221-R Evaluation Board (R34 = 10kΩ; R33 = open). For applications where the transmitter is capable of delivering only 5W, the P9221-R will automatically switch to 5V output to ensure 5W power delivery. The 5W option can be disabled by changing the value of R33 as defined in Table 6. In this case, if the receiver is placed on a 5W transmitter, the receiver output pin will be high impedance.

This pin also allows for setting the Q-factor value by adjusting R34 and R33 as shown in Table 6. The default value is set to 103 on the P9221-R Evaluation Board. For development purposes, the Q-factor should be set to 20 to avoid prematurely triggering Q-factor.

Table 6. Setting the Output Voltage and Reference Q-factor Value

Q Factor Value Setting	VOUT Setting(R34/R33 Values)							
	9V without 5V		9V with 5V		12V without 5V		12V with 5V	
	R34	R33	R34	R33	R34	R33	R34	R33
103	10kΩ	4.87kΩ	Open	10kΩ	10kΩ	21kΩ	10kΩ	Open
80	10kΩ	4.32kΩ	10kΩ	0.31kΩ	10kΩ	22.6kΩ	10kΩ	324kΩ
60	10kΩ	3.65kΩ	10kΩ	0.681kΩ	10kΩ	27.4kΩ	10kΩ	147kΩ
40	10kΩ	3.09kΩ	10kΩ	1.1kΩ	10kΩ	32.4kΩ	10kΩ	90.9kΩ
20	10kΩ	2.55kΩ	10kΩ	1.54kΩ	10kΩ	39.2kΩ	10kΩ	64.9kΩ

8.3 SINK Pin

The P9221-R has an internal automatic DC clamping to protect the device in the event of high voltage transients. The VRECT node must be connected to the SINK pin at all times using a 36Ω resistor with a greater than ¼ W rating.

8.4 Rectifier Voltage – VRECT

The P9221-R uses a high-efficiency synchronous rectifier to convert the AC signal from the coil to a DC signal on the VRECT pin. During startup, the rectifier operates as a passive diode bridge. Once the voltage on VRECT exceeds the under-voltage lock-out level (UVLO; see Table 5), the rectifier will switch into full synchronous bridge rectifier mode. A total capacitance of 30μF is recommended to minimize the output voltage ripple. A 0.1μF capacitor is added for decoupling.

8.5 Over-Current Limit – ILIM

The P9221-R has a programmable current limit function for protecting the device in the event of an over-current or short-circuit fault condition. When the output current exceeds the programmed threshold (see Figure 11), the P9221-R will limit the load current by reducing the output voltage. The current limit should be set to 120% of the target maximum output current. See the ILIM pin description in Table 1 for further information. The ILIM pin allows changing the over-current limit value without modification of the firmware by selecting the values of R38 and R22 as shown in Table 7.

Table 7. Setting the Over Current Limit

Voltage on ILIM Pin [V]	R38 [kΩ]	R22 [kΩ]	Output Current [A]	Over-Current Limit [A]
Pull-up	10	Open	1.25	1.6
0.60	10	5.1	0.80	1
0.45	10	3.3	0.64	0.8
0.25	10	1.6	0.40	0.5

8.6 Interrupt Function – $\overline{\text{INT}}$

The P9221-R provides an open-drain, active-LOW interrupt output pin. It is asserted LOW when $\overline{\text{EN}}$ is HIGH or any of the following fault conditions have been triggered: the die temperature exceeds 140°C, the external thermistor measurement exceeds the threshold (see section 8.9), or an over-current (OC) or over-voltage (OV) condition is detected.

During normal operation, the $\overline{\text{INT}}$ pin is pulled HIGH. This pin can be connected to the interrupt pin of a microcontroller. The source of the trigger for the interrupt is available in the I²C *Interrupt Status* register (see Table 13).

8.7 Enable Pin – $\overline{\text{EN}}$

The P9221-R can be disabled by applying a logic HIGH to the $\overline{\text{EN}}$ pin. When the $\overline{\text{EN}}$ pin is pulled HIGH, the device is in Shut-Down Mode. Connecting the $\overline{\text{EN}}$ pin to logic LOW activates the device.

8.8 Thermal Protection

The P9221-R integrates thermal shutdown circuitry to prevent damage resulting from excessive thermal stress that may be encountered under fault conditions. This circuitry will shut down or reset the P9221-R if the die temperature exceeds 140°C.

8.9 External Temperature Sensing and End of Charge – TS/EOC

The P9221-R has a temperature sensor input which can be used to monitor an external temperature by using a thermistor. The built-in comparator's reference voltage is 0.6V and 0.1V in the P9221-R, and it is used for monitoring the voltage level on the TS/EOC pin as described by Equation 1.

$$V_{TS} = V_{VDD18} \times \frac{NTC}{R + NTC} \quad \text{Equation 1}$$

Where NTC is the thermistor's resistance and R is the pull-up resistor connected to VDD18 pin. The over-temperature shutdown is triggered when the TS pin voltage is between 0.6V and 0.1V; for more information, see Figure 24.

When the TS/EOC pin is less than 0.1V, the End of Charge (EOC) function is activated, and the P9221-R will send the End Power Transfer (EPT) packet to the transmitter terminating the power delivery.

8.10 Alignment Guide – ALIGNX and ALIGNY

This feature is used to provide directional information regarding the transmit coil and receive coil alignment while the wireless charger is in normal operation mode. Sensing coils (see the basic application circuit on the first page) are placed on the wireless power receiver side between the power Rx coil and power Tx coil. Special design enables the sensing coils to output zero voltage when the alignment is optimum while misalignment between the transmitter and receiver coils will result in a voltage on the sensing coils. These signals are internally rectified, filtered, and passed through the ADC providing quantitative information on the amount of misalignment. The higher the signal is, the more the coils are misaligned.

Furthermore, the signal magnitude on ALIGNX and ALIGNY provides directional information by measuring the phase between the input power AC signal and horizontal and vertical alignment signals. Once the signal passes through the ADC, the alignment information is represented by two 8-bit signed numbers, which can be read from the Alignment X Value and Alignment Y Value I²C registers defined in Table 22 and Table 23 respectively, which indicate the misalignment direction and magnitude.

The application processor can provide 2D visual graphics that suggest how much the power coils are misaligned in each direction and can suggest that the user move the device on the Tx pad for the best alignment to improve the power transferred and reduce the charging time.

8.11 Advanced Foreign Object Detection (FOD)

When metallic objects are exposed to an alternating magnetic field, eddy currents cause such objects to heat up. Examples of such parasitic metal objects are coins, keys, paper clips, etc. The amount of heating depends on the strength of the coupled magnetic field, as well as on the characteristics of the object, such as its resistivity, size, and shape. In a wireless power transfer system, the heating manifests itself as a power loss, and therefore a reduction in power-transfer efficiency. Moreover, if no appropriate measures are taken, the heating could be sufficient that the foreign object could become heated to an unsafe temperature.

During the power transfer phase (see section 10.6), the receiver periodically communicates to the transmitter the amount of power received by means of a Received Power Packet (RPP). The transmitter will compare this power with the amount of power transmitted during the same time period. If there is a significant unexplained loss of power, then the transmitter will shut off power delivery because a possible foreign object might be absorbing too much energy.

For a WPC system to perform this function with sufficient accuracy, both the transmitter and receiver must account for and compensate for all of their known losses. Such losses could be due to resistive losses or nearby metals that are part of the transmitter or receiver, etc. Because the system accurately measures its power and accounts for all known losses, it can thereby detect foreign objects because they cause an unknown loss. The WPC specification requires that a power receiver must report to the power transmitter its received power (P_{PR}) in an RPP. The maximum value of the received power accuracy P_{Δ} depends on the maximum power of the power receiver as defined in Table 8.

The power receiver must determine its P_{PR} with an accuracy of $\pm P_{\Delta}$, and report its received power as $P_{RECEIVED} = P_{PR} + P_{\Delta}$. This means that the reported received power is always greater than or equal to the transmitted power (P_{PT}) if there is no foreign object (FO) present on the interface surface.

Table 8. Maximum Estimated Power Loss

Maximum Power [W]	Maximum P_{Δ} [mW]
15	750

The compensation algorithm includes values that are programmable via either the I²C interface or OTP (one-time programmable) bits. Programmability is necessary so that the calibration settings can be optimized to match the power transfer characteristics of each particular WPC system to include the power losses of the transmit and receive coils, battery, shielding, and case materials under no-load to full-load conditions. The values are based on the comparison of the received power against a reference power curve so that any foreign object can be sensed when the received power is different than the expected system power.

8.12 Received Power Packet Offset and Gain Calibration – RPPO and RPPG

The received power packet offset (RPPO) and received power packet gain (RPPG) calibrations utilize dedicated pins for tuning foreign object detection (FOD). These calibrations tune the received power packet via the voltage levels on the RPPO and RPPG pins, which are determined by the external resistors in divider networks on the 1.8V bias voltage. The voltage level on the RPPO pin is used to add offset in order to shift the Received Power Packet (RPP) globally, and the voltage level on the RPPG pin adjusts the slope gain of the Received Power Packet (RPP).

- The received power packet offset calibration can be tuned by varying the voltage on the RPPO pin from 0.1V to 2.1V corresponding to a power offset range from -1.56W to 2.34W.
- The received power packet gain can be tuned by varying the voltage on the RPPG pin from 0.1V to 2.1V corresponding to a gain setting in the range from 0.111 to 2.33.
- To disable the FOD, the RPP0 and RPPG must be connected to GND.

The RPP is adjusted according to Equation 2:

$$RPP [mW] = P_{measured} [mW] \times \frac{RPPG [\%]}{1755 [\%]} + RPPO [mW] - 1755 [mW] \quad \text{Equation 2}$$

Where

RPP = Received Power Packet

$P_{measured}$ = measured power from output voltage and current

$$RPPO [mW] = \frac{V_{RPPO} [V]}{2.1 [V]} \times 4095 [mW] \quad \text{Equation 3}$$

$$RPPG [\%] = \frac{V_{RPPG} [V]}{2.1 [V]} \times 4095 [\%] \quad \text{Equation 4}$$

For example, if the voltage on the RPPO and RPPG pins is 0.9V then the RPP will have no offset or gain. The RPP will be exactly the same as the measured power in the receiver.

9. Communication Interface

9.1 Modulation/Communication

The wireless medium power charging system uses two-way communication: receiver-to-transmitter and transmitter-to receiver.

Receiver-to-transmitter communication is accomplished by modulating the load seen by the receiver's inductor; the communication is purely digital and symbols 1's and 0's ride on top of the power signal that exists between the two coils. Modulation is done with amplitude-shift keying (ASK) modulation using internal switches to connect external capacitors from AC1 and AC2 to ground (see Figure 17) with a bit rate of 2Kbps. To the transmitter, this appears as an impedance change, which results in measurable variations of the transmitter's output waveform. The power transmitter detects this as a modulation of coil current/voltage to receive the packets. See sections 9.2 and 9.3 for details for ASK modulation.

Transmitter-to-receiver communication is accomplished by frequency-shift keying (FSK) modulation over the power signal frequency. The power receiver P9221-R has the means to demodulate FSK data from the power signal frequency and use it in order to establish the handshaking protocol with the power transmitter.

The P9221-R implements FSK communication when used in conjunction with WPC-compliant transmitters, such as the P9242-R. The FSK communication protocol allows the transmitter to send data to the receiver using the power transfer link in the form of modulating the power transfer signal. This modulation appears in the form of a change in the base operating frequency (f_{OP}) to the modulated operating frequency (f_{MOD}) in periods of 256 consecutive cycles. Equation 5 should be used to compute the modulated frequency based on any given operating frequency. The P9221-R will only implement positive FSK polarity adjustments; in other words, the modulated frequency will always be higher than the operating frequency during FSK communication.

Communication packets are transmitted from transmitter to receiver with less than 1% positive frequency deviation following any receiver-to-transmitter communication packet. The frequency deviation is calculated using Equation 5.

$$f_{MOD} = \frac{60000}{\frac{60000}{f_{OP}} - 3} \text{ [KHz]} \tag{Equation 5}$$

Where f_{MOD} is the changed frequency in the power signal frequency; f_{OP} is the base operating frequency of the power transfer; and 60000kHz is the internal oscillator responsible for counting the period of the power transfer signal.

The FSK byte-encoding scheme and packet structure comply with the WPC specification revision 1.2.3. The FSK communication uses a bi-phase encoding scheme to modulate data bits into the power transfer signal. The start bit will consist of 512 consecutive f_{MOD} cycles (or logic '0'). A logic '1' value will be sent by sending 256 consecutive f_{OP} cycles followed by 256 f_{MOD} cycles or vice versa, and a logic '0' is sent by sending 512 consecutive f_{MOD} or f_{OP} cycles.

Figure 18. Example of Differential Bi-phase Decoding for FSK

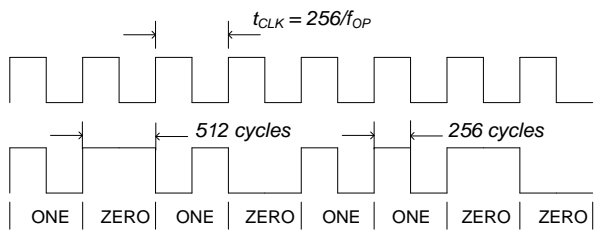

Each byte will comply with the start, data, parity, and stop asynchronous serial format structure shown in Figure 19:

Figure 19. Example of Asynchronous Serial Byte Format for FSK

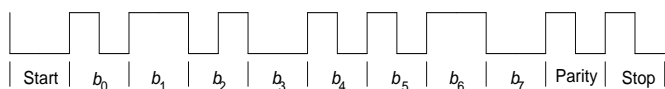

9.2 Bit Encoding Scheme for ASK

As required by the WPC, the P9221-R uses a differential bi-phase encoding scheme to modulate data bits onto the power signal. A clock frequency of 2kHz is used for this purpose. A logic ONE bit is encoded using two narrow transitions, whereas a logic ZERO bit is encoded using one wider transition as shown below:

Figure 20. Bit Encoding Scheme

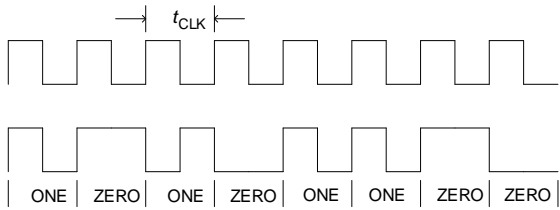

9.3 Byte Encoding for ASK

Each byte in the communication packet comprises 11 bits in an asynchronous serial format, as shown in Figure 21.

Figure 21. Byte Encoding Scheme

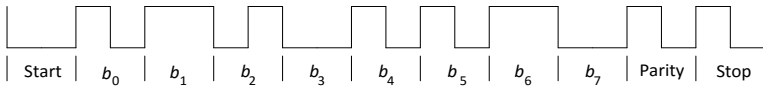

Each byte has a start bit, 8 data bits, a parity bit, and a single stop bit.

9.4 Packet Structure

The P9221-R communicates with the base station via communication packets. Each communication packet has the following structure:

Figure 22. Communication Packet Structure

Preamble	Header	Message	Checksum
----------	--------	---------	----------

10. WPC Mode Characteristics

The Extended Power Profile adds a negotiation phase, a calibration phase, and renegotiation phase to the basic system control functionality of the Base line Power Profile, as shown in Figure 23.

Figure 23. WPC Power Transfer Phases Flowchart

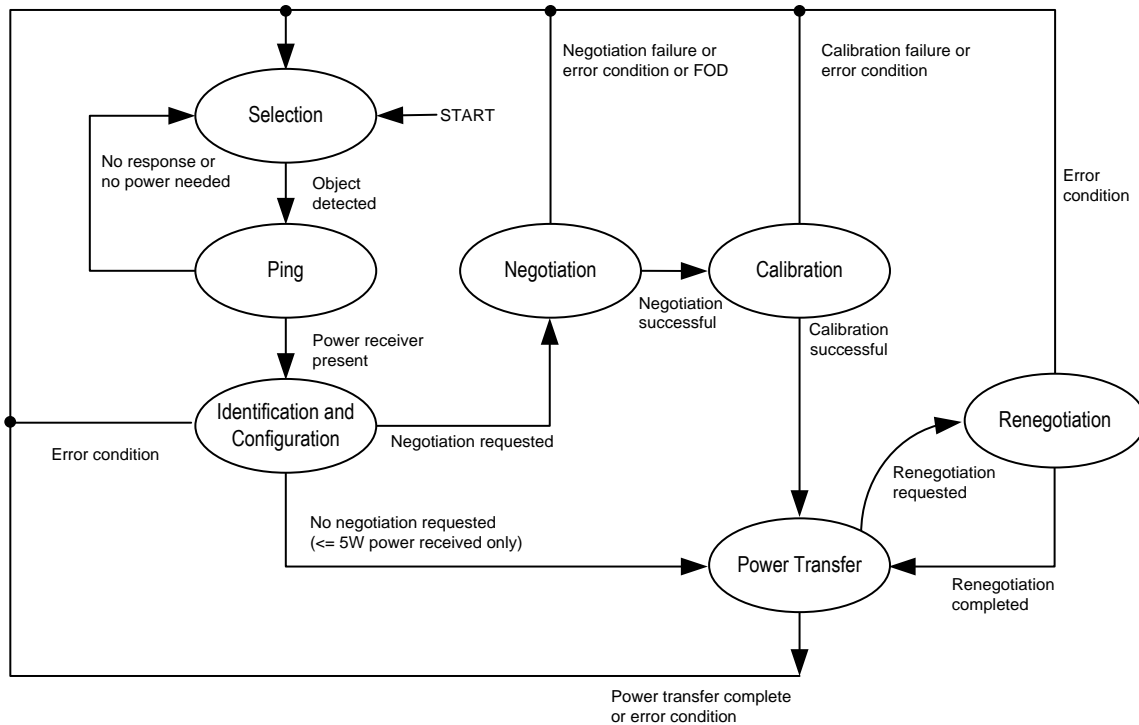

10.1 Selection Phase or Startup

In the selection phase, the power transmitter determines if it will proceed to the ping phase after detecting the placement of an object. In this phase, the power transmitter typically monitors the interface surface for the placement and removal of objects using a small measurement signal. This measurement signal should not wake up a power receiver that is positioned on the interface surface.

10.2 Ping Phase (Digital Ping)

In the ping phase, the power transmitter will transmit power and will detect the response from a possible power receiver. This response ensures the power transmitter that it is dealing with a power receiver rather than some unknown object. When a mobile device containing the P9221-R is placed on a WPC “Qi” charging pad, it responds to the application of a power signal by rectifying this power signal. When the voltage on VRECT is greater than the UVLO threshold, then the internal bandgaps, reference voltage, and the internal voltage regulators (5V and 1.8V) are turned on, and the microcontroller’s startup is initiated enabling the WPC communication protocol.

If the power transmitter correctly receives a signal strength packet, the power transmitter proceeds to the identification and configuration phase of the power transfer, maintaining the power signal output.

10.3 Identification and Configuration Phase

The identification and configuration phase is the part of the protocol that the power transmitter executes in order to identify the power receiver and establish a default power transfer contract. This protocol extends the digital ping in order to enable the power receiver to communicate the relevant information.

In this phase, the power receiver identifies itself and provides information for a default power transfer contract:

- It sends the configuration packet.
- If the power transmitter does not acknowledge the request (does not transmit FSK modulation), the power receiver will assume 5W output power.

10.4 Negotiation Phase

In the negotiation phase, the power receiver negotiates changes to the default power transfer contract. In addition, the power receiver verifies that the power transmitter has not detected a foreign object.

10.5 Calibration Phase

In the calibration phase, the power receiver provides information that the power transmitter can use to improve its ability to detect foreign objects during power transfer.

10.6 Power Transfer Phase

In this phase, the P9221-R controls the power transfer by means of the following control data packets:

- Control Error Packets
- Received Power Packet (RPP, FOD-related)
- End Power Transfer (EPT) Packet

Once the “identification and configuration” phase is completed, the transmitter initiates the power transfer mode. The P9221-R control circuit measures the rectifier voltage and sends error packets to the transmitter to adjust the rectifier voltage to the level required to maximize the efficiency of the linear regulator and to send to the transmitter the actual received power packet for foreign object detection (FOD) to guarantee safe, efficient power transfer.

In the event of an EPT issued by the application, the P9221-R turns off the LDO and continuously sends EPT packets until the transmitter removes the power and the rectified voltage on the receiver side drops below the UVLO threshold.

11. Functional Registers

The following tables provide the address locations, field names, available operations (R or RW), default values, and functional descriptions of all the internally accessible registers contained within the P9221-R. The default I²C slave address is 61_{HEX}. The address of each register has a two-byte structure. For example, the low byte of major firmware revision must be read with two bytes address with 00_{HEX} and 04_{HEX}.

Table 9. Device Identification Register

Address and Bit	Register or Bit Field Name	R/W	Default	Function and Description
0000 _{HEX} [7:0]	Part_number_L	R	20 _{HEX}	P9221-R chip identification low byte
0001 _{HEX} [7:0]	Part_number_H	R	92 _{HEX}	P9221-R chip identification high byte

Table 10. Firmware Major Revision

Address and Bit	Register or Bit Field Name	R/W	Default	Function and Description
0004 _{HEX} [7:0]	FW_Major_Rev_L	R	01 _{HEX}	Major firmware revision low byte
0005 _{HEX} [7:0]	FW_Major_Rev_H	R	00 _{HEX}	Major firmware revision high byte

Table 11. Firmware Minor Revision

Address and Bit	Register or Bit Field Name	R/W	Default	Function and Description
0006 _{HEX} [7:0]	FW_Minor_Rev_L	R	29 _{HEX}	Minor firmware revision low byte
0007 _{HEX} [7:0]	FW_Minor_Rev_H	R	04 _{HEX}	Minor firmware revision high byte

Table 12. Status Registers

Address and Bit	Register or Bit Field Name	R/W	Default	Function and Description
0034 _{HEX} [7]	Vout_Status	R	0 _{BIN}	“0” output voltage is off. “1” output voltage is on.
0034 _{HEX} [6]	Reserved	R	0 _{BIN}	
0034 _{HEX} [5]	Reserved	R	0 _{BIN}	
0034 _{HEX} [4]	Reserved	R	0 _{BIN}	
0034 _{HEX} [3]	Reserved	R	0 _{BIN}	
0034 _{HEX} [2]	Thermal_SHTDN_Status	R	0 _{BIN}	“0” indicates no over-temperature condition exists. “1” indicates that the die temperature exceeds 130°C or the NTC reading is less than 0.6V. The P9221-R sends an End Power Transfer (EPT) packet to the transmitter.
0034 _{HEX} [1]	VRECT_OV_Status	R	0 _{BIN}	“1” indicates the rectifier voltage exceeds 20V for V _{OUT} =12V. In this case, the P9221-R sends an End Power Transfer (EPT) packet to the transmitter.

Address and Bit	Register or Bit Field Name	R/W	Default	Function and Description
0034 _{HEX} [0]	Current_Limit_Status	R	0 _{BIN}	"1" indicates the current limit has been exceeded. In this case, the P9221-R sends an End Power Transfer (EPT) packet to the transmitter.
0035 _{HEX} [7:0]	Reserved	R	00 _{HEX}	

Table 13. Interrupt Status Registers

Address and Bit	Register or Bit Field Name	R/W	Default	Function and Description
0036 _{HEX} [7]	INT_Vout_Status	R	0 _{BIN}	"0" indicates the output voltage has not changed. "1" indicates the output voltage changed.
0036 _{HEX} [6]	Reserved	R	0 _{BIN}	
0036 _{HEX} [5]	Reserved	R	0 _{BIN}	
0036 _{HEX} [4]	Reserved	R	0 _{BIN}	
0036 _{HEX} [3]	Reserved	R	0 _{BIN}	
0036 _{HEX} [2]	INT_OVER_TEMP_Status	R	0 _{BIN}	"1" indicates an over-temperature condition exists.
0036 _{HEX} [1]	INT_VRECT_OV_Status	R	0 _{BIN}	"1" indicates a rectifier over-voltage condition exists.
0036 _{HEX} [0]	INT_OC_Limit_Status	R	0	"1" indicates the current limit has been exceeded.
0037 _{HEX} [7:0]	Reserved	R	00 _{HEX}	

Note: If any bit in the *Interrupt Status* register 36_{HEX} is "1" and the corresponding bit in the *Interrupt Enable* register 38_{HEX} is set to "1," the INT pin will be pulled down indicating an interrupt event has occurred.

Table 14. Interrupt Enable Registers

Address and Bit	Register or Bit Field Name	R/W	Default	Function and Description
0038 _{HEX} [7]	Vout_Status_INT_EN	RW	0 _{BIN}	"0" disables the <i>INT_Vout_Status</i> interrupt. "1" enables the interrupt.
0038 _{HEX} [6]	Reserved	R	0 _{BIN}	
0038 _{HEX} [5]	Reserved	R	0 _{BIN}	
0038 _{HEX} [4]	Reserved	R	1 _{BIN}	
0038 _{HEX} [3]	Reserved	R	1 _{BIN}	
0038 _{HEX} [2]	OVER_TEMP_INT_EN	R	1 _{BIN}	"0" disables the <i>INT_OVER_TEMP</i> interrupt. "1" enables the interrupt.
0038 _{HEX} [1]	VRECT_OV_INT_EN	RW	1 _{BIN}	"0" disables the <i>INT_VRECT_OV</i> interrupt. "1" enables the interrupt.
0038 _{HEX} [0]	OC_Limit_Status_INT_EN	RW	1 _{BIN}	"0" disables the <i>INT_OC_Limit_Status</i> interrupt. "1" enables the interrupt.
0039 _{HEX} [7:0]	Reserved	RW	00 _{HEX}	

Table 15. Battery Charge Status

Address and Bit	Register or Bit Field Name	R/W	Default	Function and Description
003A _{HEX} [7:0]	Batt_Charg_status	R/W	00 _{HEX}	Battery charge status value sent to transmitter. ^[a]

[a] Firmware only forwards the data from the application processor to transmitter.

Table 16. End Power Transfer

The application processor initiates the End Power Transfer (EPT).

Address and Bit	Register or Bit Field Name	R/W	Default	Function and Description
003B _{HEX} [7:0]	EPT_Code	R/W	00 _{HEX}	EPT_Code sent to transmitter.

Table 17. Read Register – Output Voltage

$$V_{OUT} = \frac{ADC_VOUT * 6 * 2.1}{4095}$$

Address and Bit	Register or Bit Field Name	R/W	Default	Function and Description
003C _{HEX} [7:0]	ADC_VOUT [7:0]	R	00 _{HEX}	8 LSB of VOUT ADC value.
003D _{HEX} [7:4]	Reserved	R	0 _{HEX}	Reserved.
003D _{HEX} [3:0]	ADC_VOUT [11:8]	R	0 _{HEX}	4 MSB of VOUT ADC value.

Table 18. Read Register – VRECT Voltage

$$V_{RECT} = \frac{ADC_VRECT * 10 * 2.1}{4095}$$

Address and Bit	Register or Bit Field Name	R/W	Default	Function and Description
0040 _{HEX} [7:0]	ADC_VRECT [7:0]	R	–	8 LSB of VRECT ADC value.
0041 _{HEX} [7:4]	Reserved	R	0 _{HEX}	Reserved
0041 _{HEX} [3:0]	ADC_VRECT [11:8]	R	–	4 MSB of VRECT ADC value.

Table 19. Read Register – IOUT Current

$$I_{OUT} = \frac{RX_IOUT * 2 * 2.1}{4095}$$

Address and Bit	Register or Bit Field Name	R/W	Default	Function and Description
0044 _{HEX} [7:0]	RX_IOUT [7:0]	R _{HEX}	–	8 LSB of IOUT. Output current in mA.
0045 _{HEX} [7:0]	RX_IOUT [15:8]	R _{HEX}	–	8 MSB of IOUT. Output current in mA

Table 20. Read Register – Die Temperature

$$T_{DIE} = (ADC_Die_Temp - 1350) \frac{83}{444} - 273 \text{ where } ADC_Die_Temp = 12 \text{ bits from } ADC_Die_Temp_H \text{ and } ADC_Die_Temp_L$$

Address and Bit	Register or Bit Field Name	R/W	Default	Function and Description
0046 _{HEX} [7:0]	ADC_Die_Temp_L	R	-	8 LSB of current die temperature in °C.
0047 _{HEX} [7:4]	Reserved	R	0 _{HEX}	Reserved
0047 _{HEX} [3:0]	ADC_Die_Temp_H	R	-	4 MSB of current die temperature in °C.

Table 21. Read Register – Operating Frequency

$$f_{OP} = \frac{64 * 6000}{OP_FREQ [15:0]}$$

Address and Bit	Register or Bit Field Name	R/W	Default	Function and Description
0048 _{HEX} [7:0]	OP_FREQ[15:8]	R	-	8 MSB of the AC signal frequency [kHz].
0049 _{HEX} [7:0]	OP_FREQ[7:0]	R	-	8 LSB of the AC signal frequency [kHz].

Table 22. Alignment X Value Register

Note: Valid only in presence of the alignment PCB coil. (See section 8.10 or the *P9221-R Evaluation Kit User Manual* for more information.)

Address and Bit	Register or Bit Field Name	R/W	Default	Function and Description
004B _{HEX} [7:0]	Align_X	R	-	8-bit signed integer representing alignment between Tx and Rx coil in the X-direction. The value is application-specific.

Table 23. Alignment Y Value Register

Note: Valid only in the presence of the alignment PCB coil. (See section 8.10 or the *P9221-R Evaluation Kit User Manual* for more information.)

Address and Bit	Register or Bit Field Name	R/W	Default	Function and Description
004C _{HEX} [7:0]	Align_Y	R	-	8-bit signed integer representing alignment between Tx and Rx coil in the Y-direction. The value is application-specific.

Table 24. Command Register

Address and Bit	Register Field Name	R/W	Default	Function and Description
004E _{HEX} [7:6]	Reserved	R	0 _{HEX}	Reserved.
004E _{HEX} [5]	Clear_Interrupt	RW	0 _{HEX}	If application processor sets this bit to "1," the P9221-R clears the interrupt pin.
004E _{HEX} [4]	Send_Battery_Charge_Status packet	R	0 _{HEX}	If the application processor sets this bit to "1," the P9221-R sends the charge status packet once (from the <i>Batt_Charge_status</i> register; see Table 15) and then sets this bit to "0."
004E _{HEX} [3]	Send_End_Power_Transfer	RW	0 _{HEX}	If application processor sets this bit to "1," the P9221-R sends the end power transfer packet (defined in the <i>EPT_Code</i> register in Table 16) to the transmitter and then sets this bit to "0."
004E _{HEX} [2]	Reserved	R	0 _{HEX}	Reserved
004E _{HEX} [1]	Toggle_LDO_On-OFF	RW	0 _{HEX}	If application processor sets this bit to "1," the P9221-R toggles the LDO output once (from on to off or from off to on), and then sets this bit to "0."
004E _{HEX} [0]	Reserved	R	0 _{HEX}	Reserved

12. Application Information

12.1 Power Dissipation and Thermal Requirements

The use of integrated circuits in low-profile and fine-pitch surface-mount packages requires special attention to power dissipation. Many system-dependent issues such as thermal coupling, airflow, added heat sinks, convection surfaces, and the presence of other heat-generating components must be taken into consideration.

The P9221-R package has a maximum power dissipation of approximately 1.72W, which is governed by the number of thermal vias between the package and the printed circuit board. The die's maximum power dissipation is specified by the junction temperature and the package thermal resistance. The WLCSP package has a typical θ_{JA} of 47°C/W with 8 thermal vias and 77°C/W with no thermal vias. Maximizing the thermal vias is highly recommended.

The ambient temperature surrounding the P9221-R will also have an effect on the thermal limits of the printed circuit board (PCB). The main factors influencing thermal resistance (θ_{JA}) are the PCB characteristics and thermal vias. For example, in a typical still-air environment, a significant amount of the heat generated is absorbed by the PCB. Changing the design or configuration of the PCB changes the overall thermal resistivity and therefore the board's heat-sinking efficiency.

Three basic approaches for enhancing thermal performance are listed below:

- Improving the power dissipation capability of the PCB design
- Improving the thermal coupling of the component to the PCB.
- Introducing airflow into the system.

First, the maximum power dissipation for a given situation should be calculated using Equation 6:

$$P_{D(MAX)} = \frac{(T_{J(MAX)} - T_{AMB})}{\theta_{JA}} \quad \text{Equation 6}$$

Where $P_{D(MAX)}$ = Maximum power dissipation

θ_{JA} = Package thermal resistance (°C/W)

$T_{J(MAX)}$ = Maximum device junction temperature (°C)

T_{AMB} = Ambient temperature (°C)

The maximum recommended junction temperature ($T_{J(MAX)}$) for the P9221-R device is 125°C. The thermal resistance of the 52-WLCSP package (AHG52) is nominally $\theta_{JA}=47^{\circ}\text{C/W}$ with 8 thermal vias. Operation is specified to a maximum steady-state ambient temperature (T_{AMB}) of 85°C. Therefore, the maximum recommended power dissipation is given by Equation 7.

$$P_{D(MAX)} = \frac{(124^{\circ}\text{C} - 85^{\circ}\text{C})}{47^{\circ}\text{C/W}} \cong 0.85 \text{ Watt} \quad \text{Equation 7}$$

All the above-mentioned thermal resistances were determined with the P9221-R mounted on a standard board of the dimensions and characteristics specified by the JEDEC 51 standard.

12.2 Recommended Coils

The following coils are recommended with the P9221-R receiver for 15W applications for optimum performance. The recommended vendor coils have been tested and verified as shown in Table 25.

Table 25. Recommended Coil Manufacturers

Output Power	Vendor	Part number	Inductance at 100kHz	ACR at 20°C	Series Resonant Capacitance
15W	AMOTECH	ASC-504060E00-S00	8.2μH	220mΩ	400nF
15W	TDK	WR424245-13K2-G	11.2μH	170mΩ	300nF
15W	SUNLORD	SWA50R40H06C02B	8.4μH	150mΩ	400nF
15W	WURTH	760308102207	8.0μH	80mΩ	400nF

12.3 Typical Application Schematic

Figure 24. Typical Application Schematic – P9221-R Evaluation Board Revision 2.2

P9221-R MM EV Board V2.2

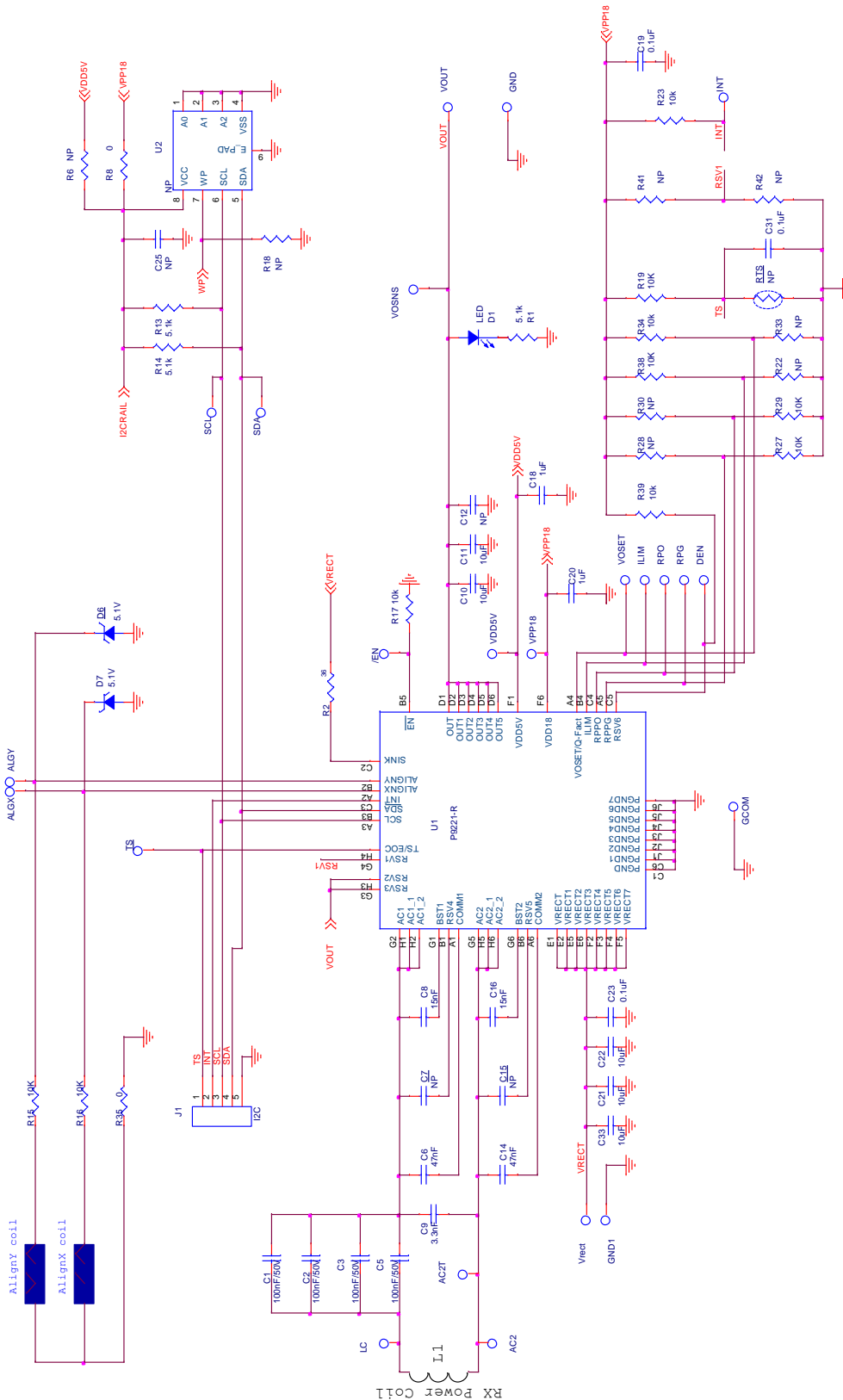

12.4 Bill of Materials (BOM)

Table 26. P9221-R MM Evaluation Kit V2.2 Bill of Materials

Item	Reference	Quantity	Value	Description	Part number	PCB Footprint
1	AC2T, VDD5V, VPP18, VOSET, TS, SDA, SCL, RPO, RPG, INT, ILIM, GCOM, DEN, ALGY, ALGX, /EN	16	PTH_TP	Test Pad		10MIL_35PAD
2	AC2, LC	2	NP	TEST POINT		test_pt_sm_135x70
3	C1, C2, C3, C5	4	100nF	CAP CER 0.1μF 50V X5R 0402	GRM155R61H104KE19D	0402
4	C6, C14	2	47nF	CAP CER 0.047μF 50V X7R 0402	C1005X7R1H473K050BB	0402
5	C7, C15	2	NP	CAP CER 0.047μF 50V X7R 0402	C1005X7R1H473K050BB	0402
6	C8, C16	2	15nF	CAP CER 0.015μF 50V X7R 0402	GRM155R71H153KA12J	0402
7	C9	1	3.3nF	CAP CER 3300PF 50V X7R 0402	CL05B332KB5NNNC	0402
8	C10, C11, C21, C22, C33	5	10μF	CAP CER 10μF 25V X5R 0603	CL10A106MA8NRNC	0603
9	C12	1	NP	CAP CER 10μF 25V X5R 0603	CL10A106MA8NRNC	0603
10	C18,C20	2	1μF	CAP CER 1μF 10V X5R 0402	GRM155R61A105KE15D	0402
11	C19,C31	2	0.1μF	CAP CER 0.1μF 10V X5R 0201	C0603X5R1A104K030BC	0201
12	C23	1	0.1μF	CAP CER 0.1μF 25V X5R 0201	CL03A104KA3NNNC	0201
13	C25	1	NP	CAP CER 0.1μF 10V X5R 0201	C0603X5R1A104K030BC	0201
14	D1	1	LED	LED GREEN CLEAR 0603 SMD	150 060 GS7 500 0	0603_diode
15	D6,D7	2	5.1V	DIODE ZENER 5.1V 100MW 0201	CZRZ5V1B-HF	0201
16	GND1, VRECT, VOUT, VOSNS, GND	5	Test Point	TEST POINT PC MINIATURE SMT	5015	test_pt_sm_135x70
17	J1	1	I ² C	HEADER_1X5_0P1PITCH60P42D	68002-205HLF	header_1x5_0p1Pit ch60p42d
18	RTS	1	NP			NTC2
19	R1, R13, R14	3	5.1kΩ	RES SMD 5.1K OHM 5% 1/16W 0402	MCR01MRTJ512	0402
20	R2	1	36Ω	RES SMD 36 OHM 5% 1/2W 0805	ERJ-P06J360V	0805
21	R6	1	NP	RES SMD 0.0OHM JUMPER	ERJ-2GE0R00X	0402
22	R8	1	0Ω	RES SMD 0.0OHM JUMPER 1/10W 0402	ERJ-2GE0R00X	0402
23	R15, R16	2	10KΩ	RES SMD 10K OHM 1% 1/10W 0603	RC0603FR-0710KL	0603

Item	Reference	Quantity	Value	Description	Part number	PCB Footprint
24	R17, R19, R23, R27, R29, R34, R38, R39	8	10k Ω	RES SMD 10K OHM 5% 1/16W 0402	CRCW040210K0JNEDIF	0402
25	R18, R22, R28, R30, R33, R41, R42	7	NP	RES SMD 10K OHM 5% 1/16W 0402	CRCW040210K0JNEDIF	0402
26	R35	1	0 Ω	RES SMD 0.0OHM 1/10W 0603	MCR03EZPJ000	0603
27	U1	1	P9221-R	MP Wireless power receiver	P9221-R	csp52_2p64x3p94_0p4mm
28	U2	1	NP	IC EEPROM 128KBIT 400KHZ 8TDFN	24AA128T-I/MNY	TDFN08

13. Package Drawings

Figure 25. Package Outline Drawing (AHG52)

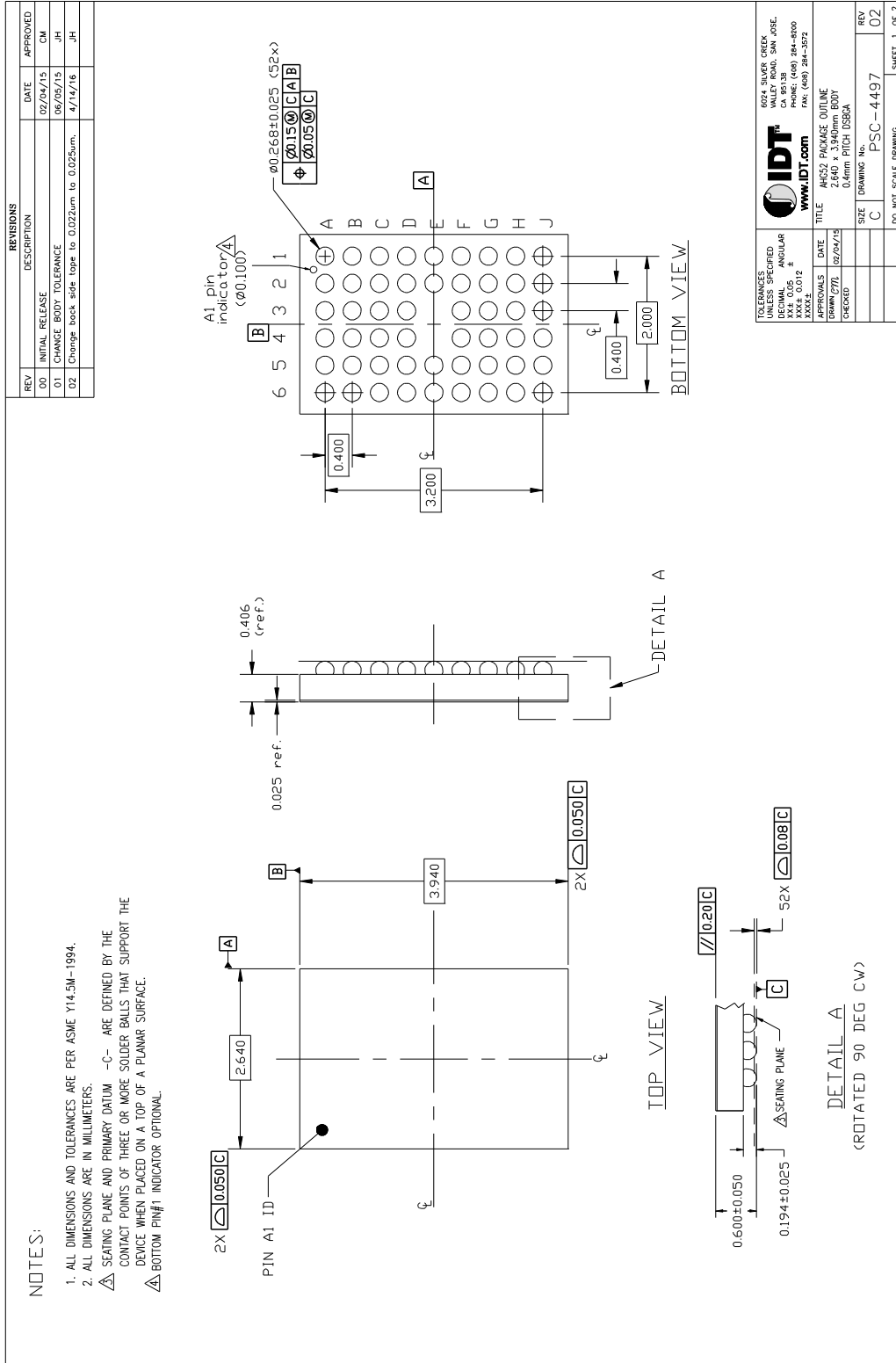

14. Recommended Land Pattern

Figure 26. 52-WLCSP (AHG52) Land Pattern

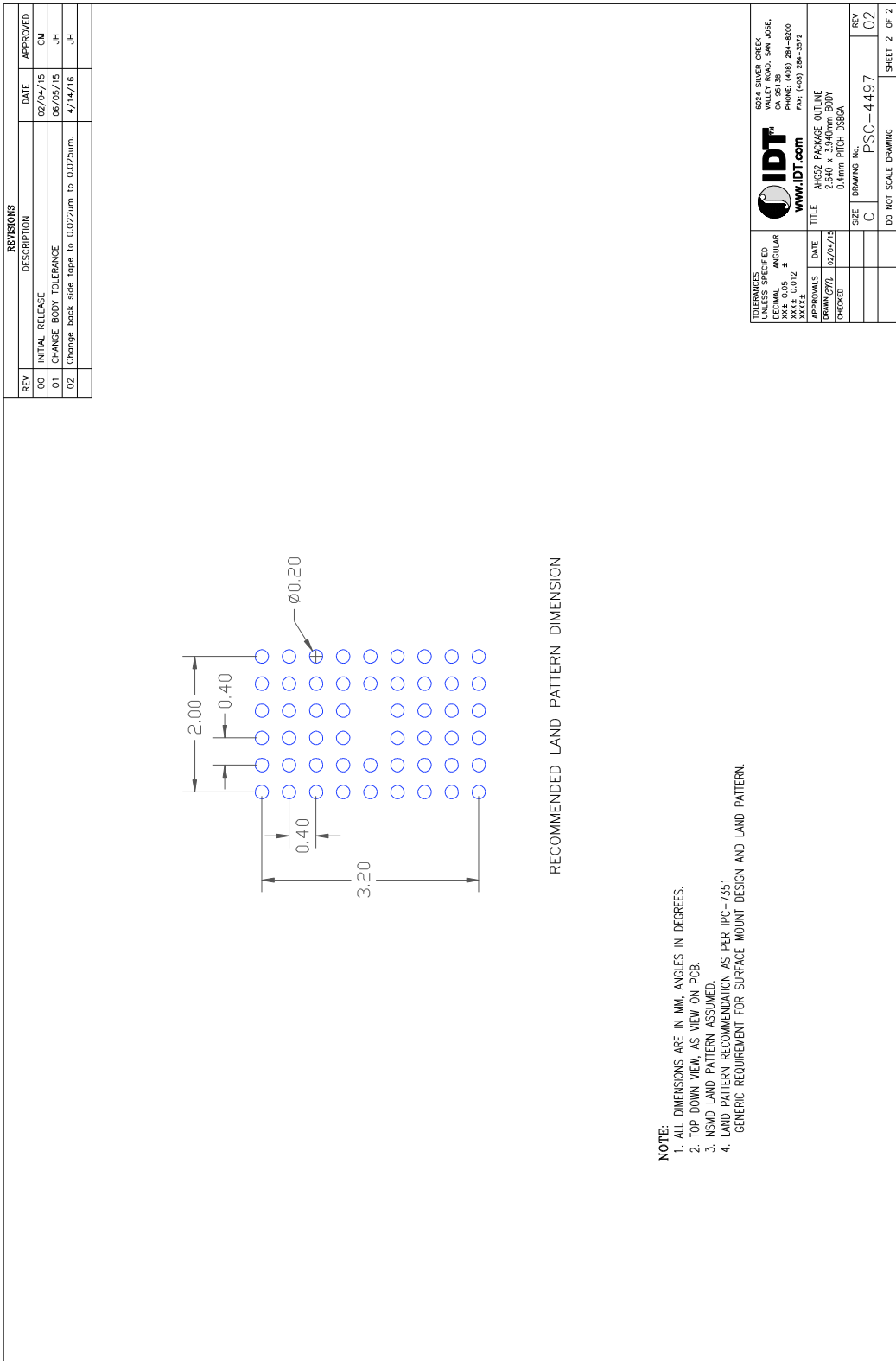

15. Special Notes: WLCSP-52 (AHG52) Package Assembly

Unopened dry packaged parts have a one-year shelf life.

The HIC indicator card for newly-opened dry packaged parts should be checked. If there is any moisture content, the parts must be baked for a minimum of 8 hours at 125°C within 24 hours of the assembly reflow process.

16. Marking Diagram

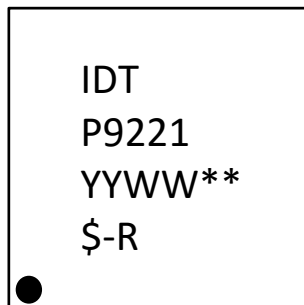

1. Line 1 company name.
2. Truncated part number.
3. "YYWW" is the last digit of the year and week that the part was assembled.
** is the lot sequential code.
4. "\$" denotes mark code, -R is part of the device part number

17. Ordering Information

Orderable Part Number	Description and Package	MSL Rating	Shipping Packaging	Ambient Temperature
P9221-RAHG18	P9221-R Wireless Power Receiver for 15W Applications, 2.64 × 3.94 mm 52-WLCSP (AHG52)	MSL1	Tape and reel	0°C to +85°C
P9221-R-EVK	P9221-R-EVK Evaluation Board			

18. Revision History

Revision Date	Description of Change
October 10, 2017	Initial release

IMPORTANT NOTICE AND DISCLAIMER

RENESAS ELECTRONICS CORPORATION AND ITS SUBSIDIARIES (“RENESAS”) PROVIDES TECHNICAL SPECIFICATIONS AND RELIABILITY DATA (INCLUDING DATASHEETS), DESIGN RESOURCES (INCLUDING REFERENCE DESIGNS), APPLICATION OR OTHER DESIGN ADVICE, WEB TOOLS, SAFETY INFORMATION, AND OTHER RESOURCES “AS IS” AND WITH ALL FAULTS, AND DISCLAIMS ALL WARRANTIES, EXPRESS OR IMPLIED, INCLUDING, WITHOUT LIMITATION, ANY IMPLIED WARRANTIES OF MERCHANTABILITY, FITNESS FOR A PARTICULAR PURPOSE, OR NON-INFRINGEMENT OF THIRD PARTY INTELLECTUAL PROPERTY RIGHTS.

These resources are intended for developers skilled in the art designing with Renesas products. You are solely responsible for (1) selecting the appropriate products for your application, (2) designing, validating, and testing your application, and (3) ensuring your application meets applicable standards, and any other safety, security, or other requirements. These resources are subject to change without notice. Renesas grants you permission to use these resources only for development of an application that uses Renesas products. Other reproduction or use of these resources is strictly prohibited. No license is granted to any other Renesas intellectual property or to any third party intellectual property. Renesas disclaims responsibility for, and you will fully indemnify Renesas and its representatives against, any claims, damages, costs, losses, or liabilities arising out of your use of these resources. Renesas' products are provided only subject to Renesas' Terms and Conditions of Sale or other applicable terms agreed to in writing. No use of any Renesas resources expands or otherwise alters any applicable warranties or warranty disclaimers for these products.

(Rev.1.0 Mar 2020)

Corporate Headquarters

TOYOSU FORESIA, 3-2-24 Toyosu,
Koto-ku, Tokyo 135-0061, Japan
www.renesas.com

Contact Information

For further information on a product, technology, the most up-to-date version of a document, or your nearest sales office, please visit:
www.renesas.com/contact/

Trademarks

Renesas and the Renesas logo are trademarks of Renesas Electronics Corporation. All trademarks and registered trademarks are the property of their respective owners.