

DESCRIPTION

The JCA0510D1 is a bi-directional TVS diode, utilizing leading monolithic silicon technology to provide fast response time and low ESD clamping voltage, making this device an ideal solution for protecting voltage sensitive high-speed data lines. The JCA0510D1 has an ultra-low capacitance with a typical value at 0.4pF, and complies with the IEC 61000-4-2 (ESD) standard with $\pm 20\text{kV}$ air and $\pm 15\text{kV}$ contact discharge. It is assembled into an ultra-small 0.6x0.3x0.3mm lead-free DFN package. The small size, ultra-low capacitance and high ESD surge protection make JCA0510D1 an ideal choice to protect cell phone, digital video interfaces and other high speed ports.

APPLICATIONS

- ◇ Smart phones.
- ◇ Display Ports.
- ◇ MDDI Ports.
- ◇ USB Ports.
- ◇ Digital Video Interface (DVI).
- ◇ PCI Express and Serial SATA Ports.

FEATURES

- ◇ Ultra small package: 0.6x0.3x0.3mm.
- ◇ Ultra low capacitance: 0.35pF typical.
- ◇ Ultra low leakage: nA level.
- ◇ Low operating voltage: 5V.
- ◇ Low clamping voltage.
- ◇ 2-pin leadless package.
- ◇ Complies with following standards:
 - IEC 61000-4-2 (ESD) immunity test Air discharge: $\pm 20\text{kV}$
Contact discharge: $\pm 15\text{kV}$
 - IEC61000-4-5 (Lightning) 4A (8/20 μs).
- ◇ RoHS Compliant.
- ◇ Lead Finish: NiPdAu.

MECHANICAL CHARACTERISTICS

- ◇ DFN0603-2(0201) Package.
- ◇ Tape & Reel : 10,000pcs.
- ◇ Reel Size : 7 inch.

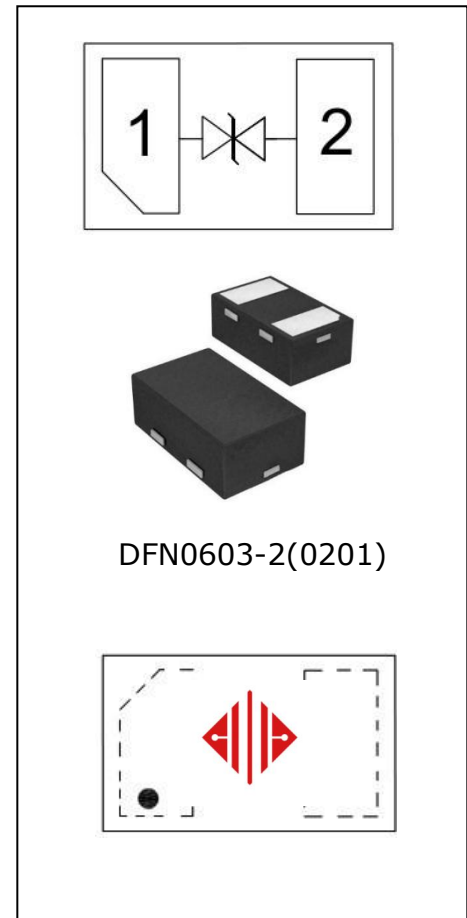

DEVICE CHARACTERISTICS

Absolute Maximum Ratings (T_A=25°C unless otherwise specified)			
Parameter	Symbol	Value	Unit
Peak Pulse Power (8/20μs)	P _{PP}	80	W
Peak Pulse Current (8/20μs)	I _{PP}	4	A
ESD per IEC 61000-4-2 (Air) ESD per IEC 61000-4-2 (Contact)	VESD	±20 ±15	kV
Operating Temperature Range	T _J	-55 to +125	°C
Storage Temperature Range	T _{stg}	-55 to +150	°C

ELECTRICAL CHARACTERISTICS(T_A=25°C unless otherwise specified)

Parameter	Symbol	Test Condition	Min	Typ	Max	Unit
Reverse Working Voltage	V _{RWM}				5.0	V
Breakdown Voltage	V _{BR}	I _T = 1mA	6.0	7.5	8.5	V
Reverse Leakage Current	I _R	V _{RWM} = 5.0V			0.5	μA
Clamping Voltage	V _C	I _{PP} = 1A (8 x 20μs pulse)			12	V
Clamping Voltage	V _C	I _{PP} = 4A (8 x 20μs pulse)			20	V
Junction Capacitance	C _J	V _R = 0V, f = 1MHz		0.35	0.4	pF

ELECTRICAL PARAMETER

Symbol	Parameter
V_{RWM}	Peak Reverse Working Voltage
I_R	Reverse Leakage Current @ V_{RWM}
V_{BR}	Breakdown Voltage @ I_T
I_T	Test Current
I_{PP}	Maximum Reverse Peak Pulse Current
V_C	Clamping Voltage @ I_{PP}

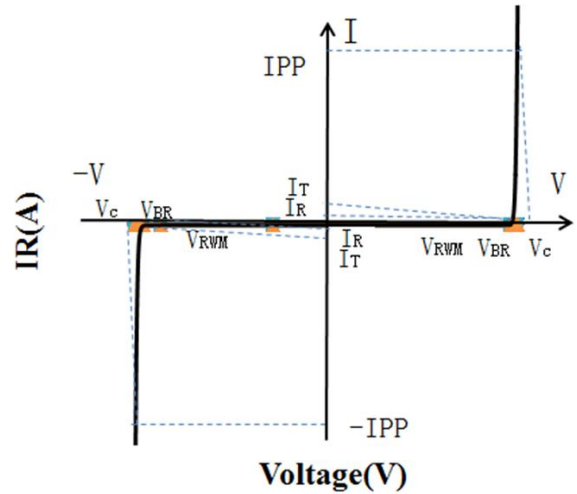

TYPICAL CHARACTERISTICS ($T_A=25^\circ C$ unless otherwise Specified)

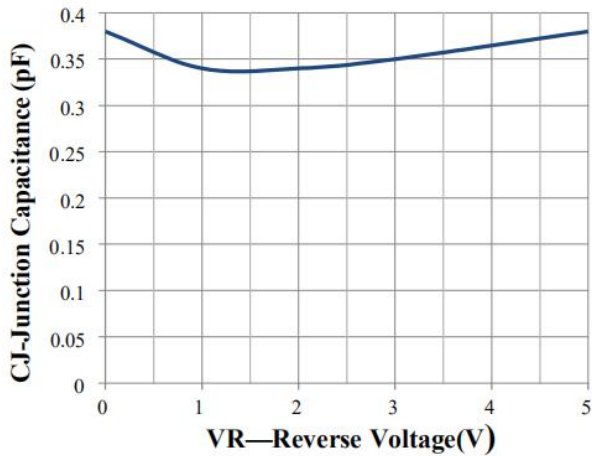

Junction Capacitance vs. Reverse Voltage

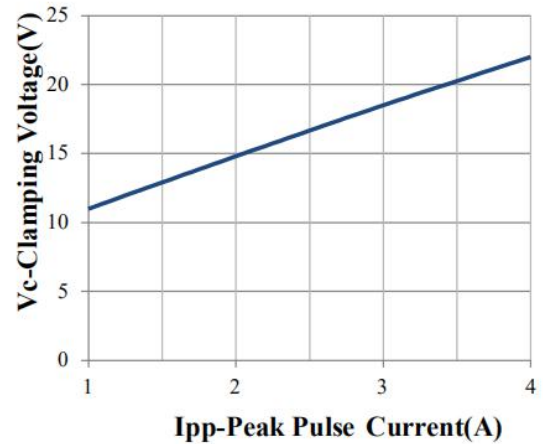

Clamping Voltage vs. Peak Pulse Current

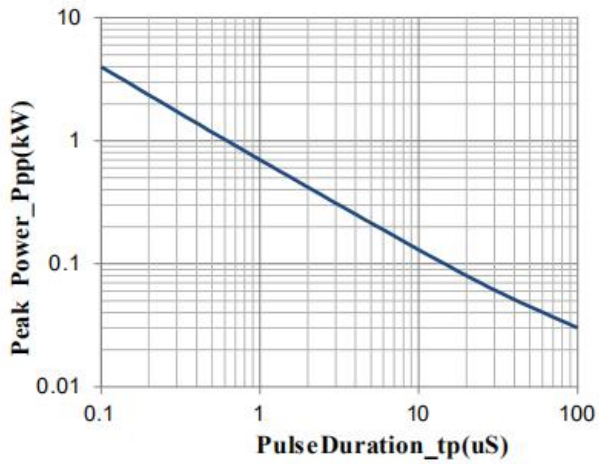

Peak Pulse Power vs. Pulse Time

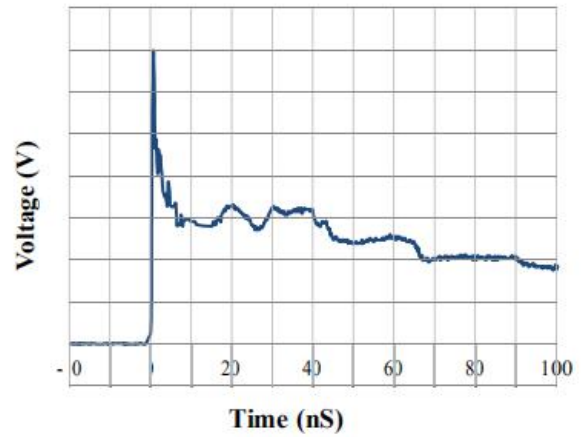

IEC61000-4-2 Pulse Waveform

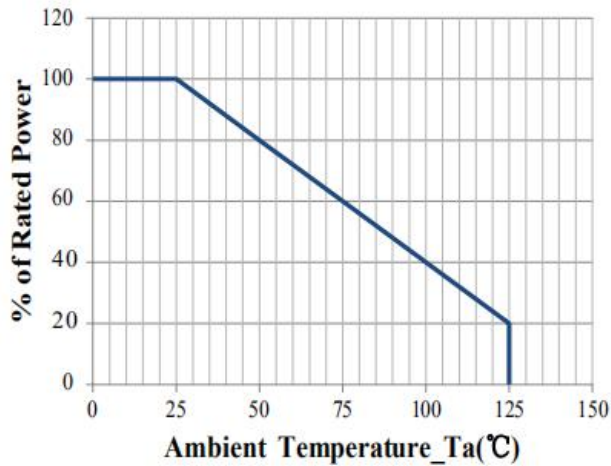

Power Derating Curve

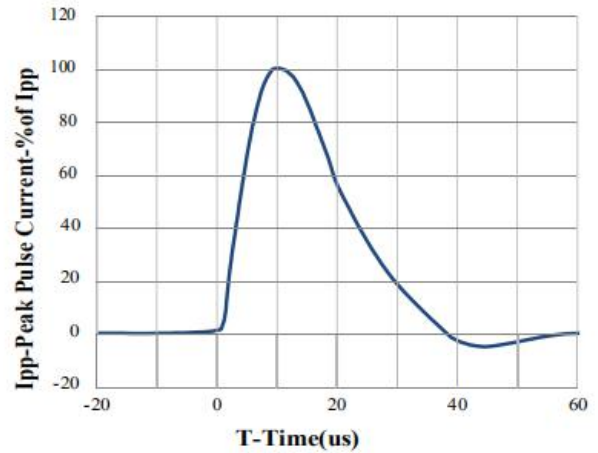

8 X 20us Pulse Waveform

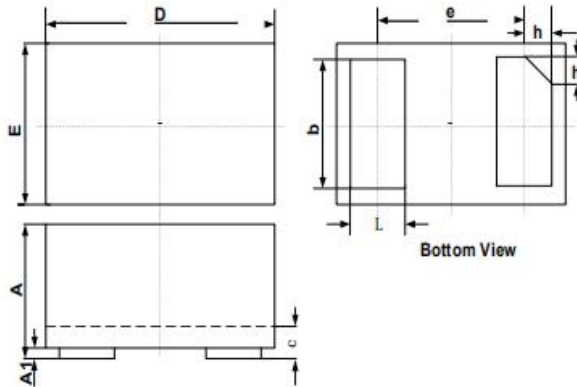
DFN0603-2(0201) PACKAGE OUTLINE & DIMENSIONS

SYM	DIMENSIONS		
	MILLIMETERS		
	MIN	NOM	MAX
A	0.230		0.330
A1	0.000	0.020	0.050
b	0.215	0.245	0.275
c	0.120	0.150	0.180
D	0.550	0.600	0.650
e	0.355 BSC		
E	0.250	0.300	0.350
L	0.160	0.190	0.220
h	0.079 BSC		

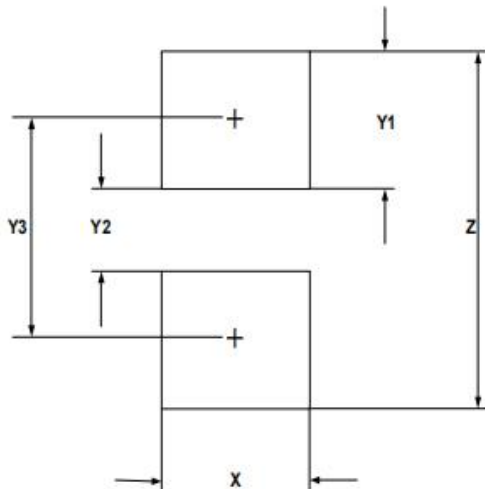
SUGGESTED LAND PATTERN

SYM	DIMENSIONS	
	MILLIMETERS	INCHES
X	0.30	0.012
Y1	0.25	0.010
Y2	0.15	0.006
Y3	0.40	0.016
Z	0.65	0.026

Website: <http://www.jksemi.com>

For additional information, please contact your local Sales Representative.

©Copyright 2016, jksemi