

## Product Summary

Symbol	Value	Unit
$I_{T(RMS)}$	1.0	A
$V_{DRM} V_{RRM}$	600/800	V
$V_{TM}$	1.55	V

## Feature

With high ability to withstand the shock loading of large current, With high commutation performances, 4 quadrants products especially recommended for use on inductive load.

## Application

Washing machine, vacuums, massager, solid state relay, AC Motor speed regulation and so on.

## Package

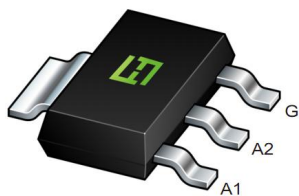

SOT-223-3L

## Circuit diagram

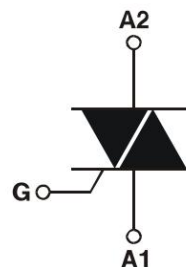

## Marking

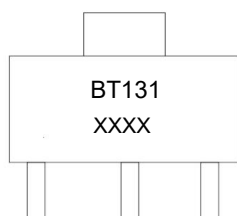

### Absolute maximum ratings (Ta=25°C unless otherwise noted)

Parameter	Symbol	Value	Unit	
Repetitive peak off-state voltage	$V_{DRM}$	600/800	V	
Repetitive peak reverse voltage	$V_{RRM}$	600/800	V	
RMS on-state current	$I_{T(RMS)}$	1	A	
Non repetitive surge peak on-state current (full cycle, F=50Hz)	$I_{TSM}$	16	A	
$I^2t$ value for fusing (tp=10ms)	$I^2t$	1.28	A <sup>2</sup> s	
Critical rate of rise of on-state current ( $I_G = 2 \times I_{GT}$ )	di/dt	I - II - III	50	A/ $\mu$ s
		IV	10	
Peak gate current	$I_{GM}$	2	A	
Average gate power dissipation	$P_{G(AV)}$	0.5	W	
Junction Temperature	$T_J$	-40 ~ +125	°C	
Storage Temperature	$T_{STG}$	-40 ~ +150	°C	

### Electrical characteristics (TA=25°C, unless otherwise noted)

Parameter	Symbol	Test Condition	Value	Unit		
Gate trigger current	$I_{GT}$	$V_D = 12V$ $I_T = 0.1A$ $T_J = 25^\circ C$	I - II - III	5	mA	
			IV	10		
Gate trigger voltage	$V_{GT}$	I - II - III - IV	MAX.	1.3	V	
Gate non-trigger voltage	$V_{GD}$	$V_D = V_{DRM}$ $T_J = 125^\circ C$	MIN.	0.2	V	
latching current	$I_L$	$V_D = 12V$ $I_{GT} = 0.1A$ $T_J = 25^\circ C$	I - III - IV	10	mA	
			II	15		
Holding current	$I_H$	I - II - III - IV	MAX.	5	mA	
Critical-rate of rise of commutation voltage	dV/dt	$V_D = 2/3V_{DRM}$ Gate Open $T_J = 125^\circ C$	MIN.	50	V/ $\mu$ s	
<b>STATIC CHARACTERISTICS</b>						
Forward "on" voltage	$V_{TM}$	$I_{TM} = 1.5A$ tp=380 $\mu$ s	MAX.	1.55	V	
Repetitive Peak Off-State Current	$I_{DRM}$	$V_D = V_{DRM}$ $V_R = V_{RRM}$	MAX.	$T_J = 25^\circ C$	5	$\mu$ A
Repetitive Peak Reverse Current	$I_{RRM}$			$T_J = 125^\circ C$	100	$\mu$ A
<b>THERMAL RESISTANCES</b>						
Thermal resistance	Rth(j-c)	Junction to case(AC)	TYP.	23	°C/W	
	Rth(j-a)	Junction to ambient	TYP.	60	°C/W	

**Typical Characteristics**

FIG.1: Maximum power dissipation versus RMS on-state current (full cycle)

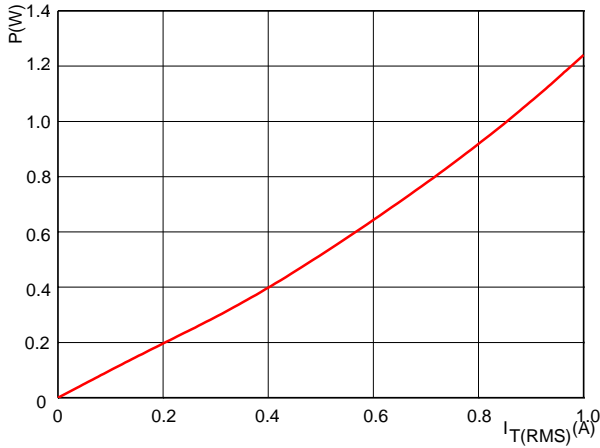

FIG.2: RMS on-state current versus case temperature (full cycle)

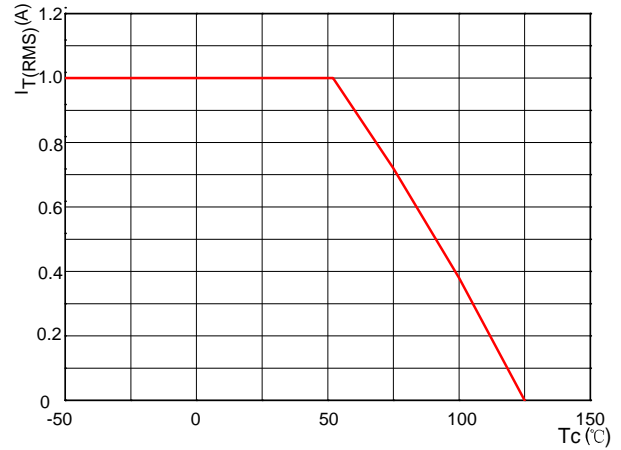

FIG.3: Surge peak on-state current versus number of cycles

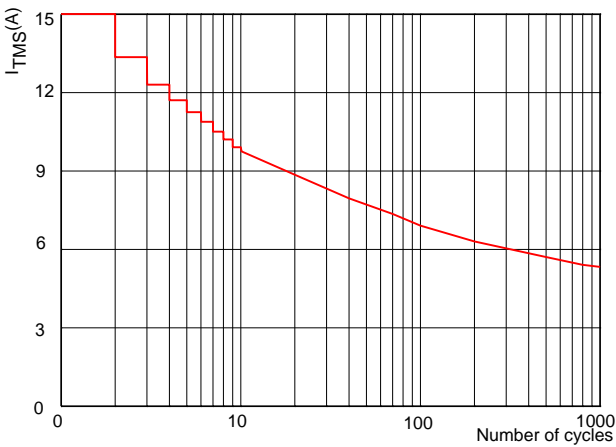

FIG.4: On-state characteristics (maximum values)

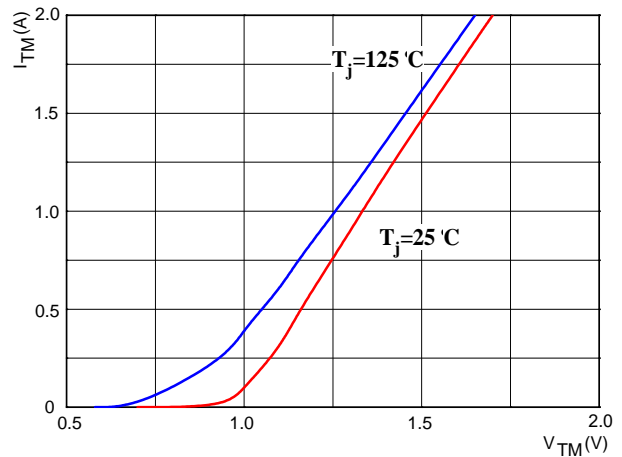

FIG.5: Non-repetitive surge peak on-state current for a sinusoidal pulse with width tp < 10ms

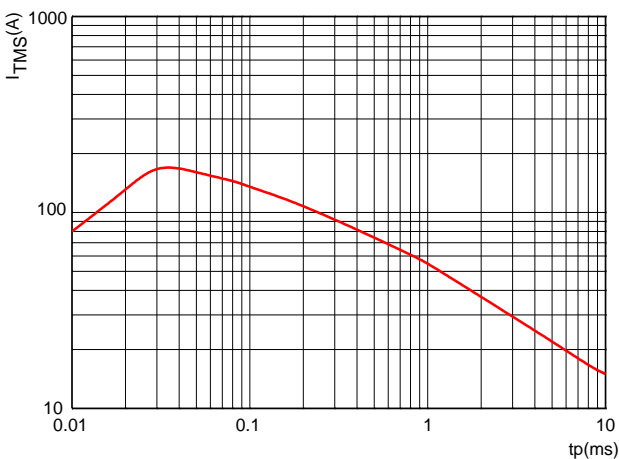
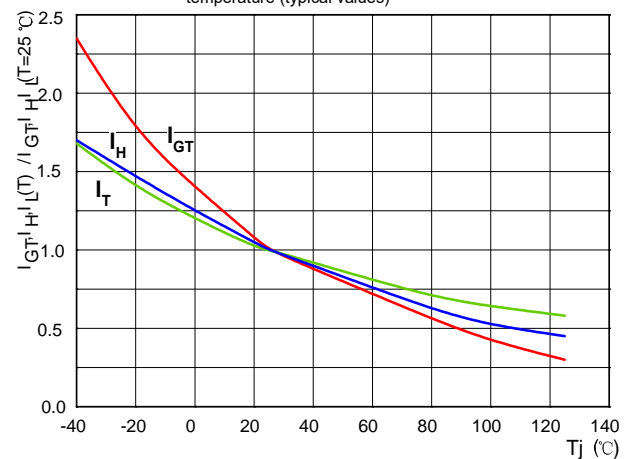
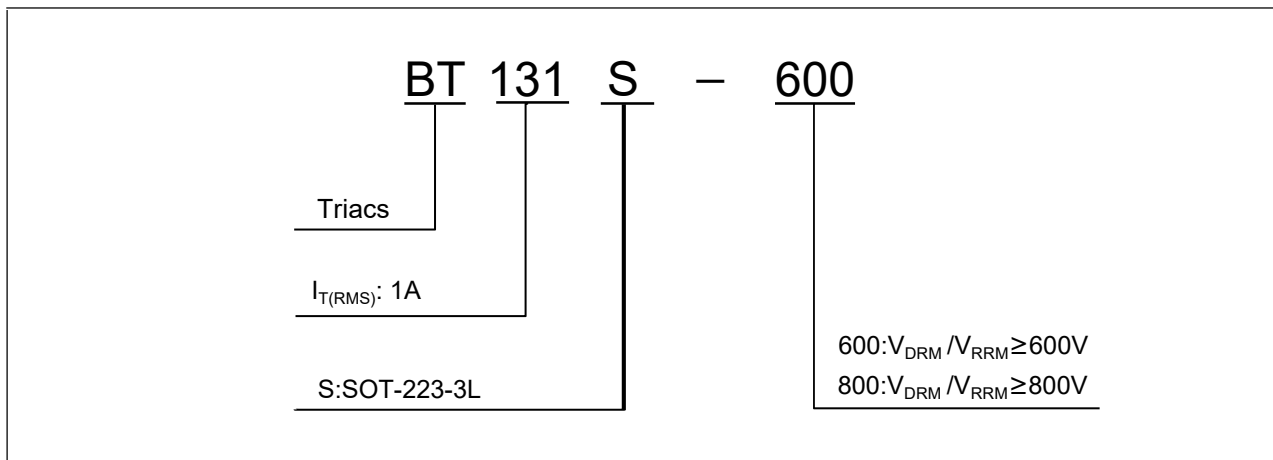

FIG.6: Relative variations of gate trigger current, holding current and latching current versus junction temperature (typical values)



## Ordering Information



## SOT-223-3L Package Information

