

SEMF05AC SERIES
5-Line Transient Voltage Suppressor Array

Revision:B

General Description

The Standard TVS are designed to low voltage, integrated circuits from transients caused by electrostatic discharge (ESD), electrical fast transients (EFT) and other induced voltages.

Applications

- Computer Notebooks
- Communication Systems & Cellular Phones
- Printers
- Personal Digital Assistant(PDA)
- Video Equipment

Features

- 100 W Peak Pulse Power per Line ($t_p=8/20\mu s$)
- Monolithic Structure
- Low Clamping Voltage
- ESD Protection > 40 kilovolts
- Low Leakage Current
- Protects up to Four (4) Bidirectional Lines and Five(5) Unidirectional Lines
- RoHS Compliant on Lead-Free Versions

Complies with the following standards

IEC61000-4-2

Level 4 15 kV (air discharge)

8 kV(contact discharge)

MIL STD 883E - Method 3015-7 Class 3

25 kV HBM (Human Body Model)

Functional Diagram

SOT-363

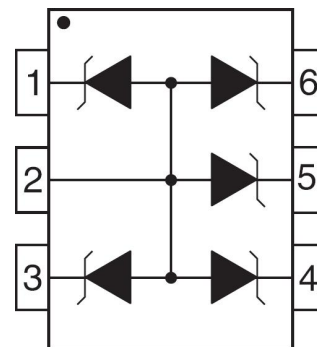

Absolute Ratings @ 25°C Unless Otherwise Specified			
Symbol	Parameter	Value	Units
P _{PP}	Peak Pulse Power ($t_p=8/20\mu s$)See Figure 1	100	Watts
T _J	Operating Temperature	-55°C to 150 °C	°C
T _{STG}	Storage Temperature	-55°C to 150°C	°C

SEMF05AC SERIES

Electrical Parameter

Symbol	Parameter
I_{PP}	Maximum Reverse Peak Pulse Current
V_C	Clamping Voltage @ I_{PP}
V_{RWM}	Working Peak Reverse Voltage
I_R	Maximum Reverse Leakage Current @ V_{RWM}
I_T	Test Current
V_{BR}	Breakdown Voltage @ I_T
I_F	Forward Current
V_F	Forward Voltage @ I_F

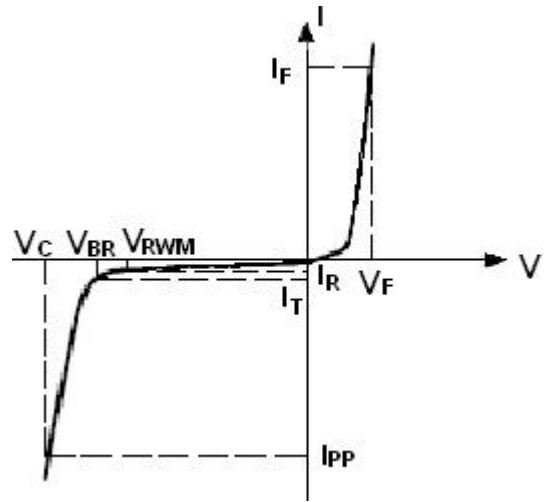

Electrical Characteristics

Part Numbers	V_{BR}			I_T	V_{RWM}	I_R	C
	Min.	Typ.	Max.				Typ. 0v bias
	V	V	V				pF
SEMF05AC	6.1	6.7	7.2	1	5.0	5	35

Typical Characteristics

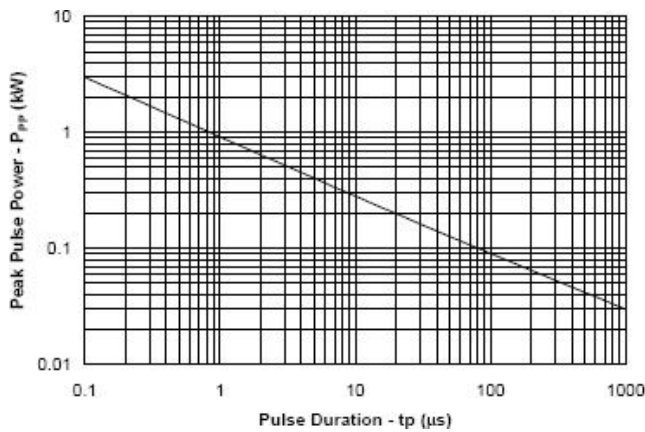

Fig1. Non-Repetitive Peak Pulse Power vs. Pulse Time

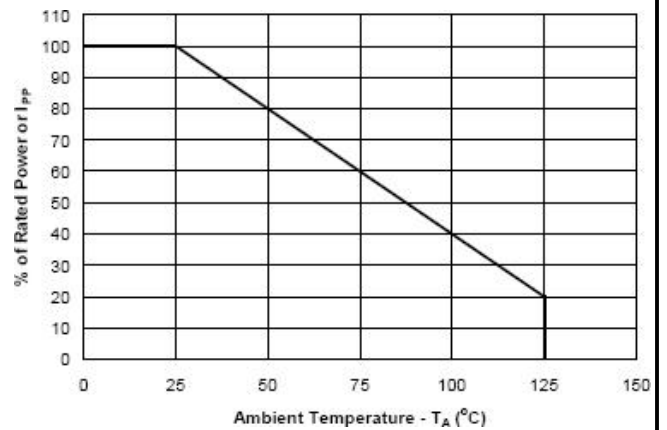

Fig2. Power Derating Curve

SEMF05AC SERIES

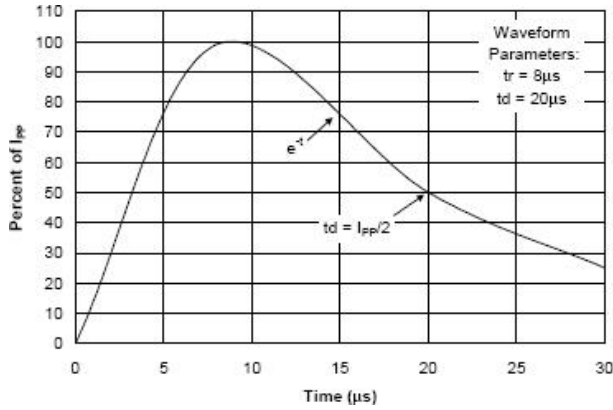

Fig3. Pulse Waveform

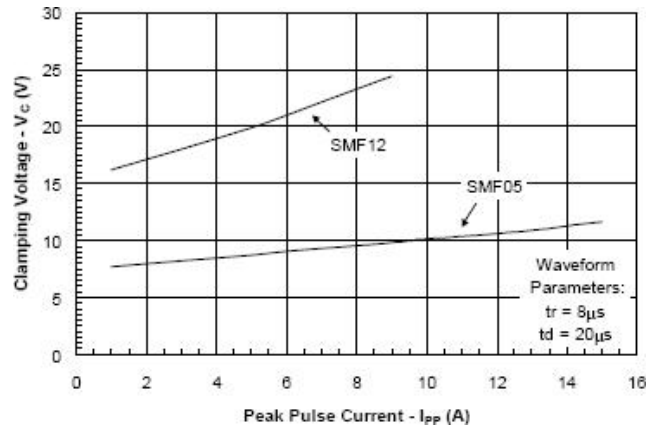
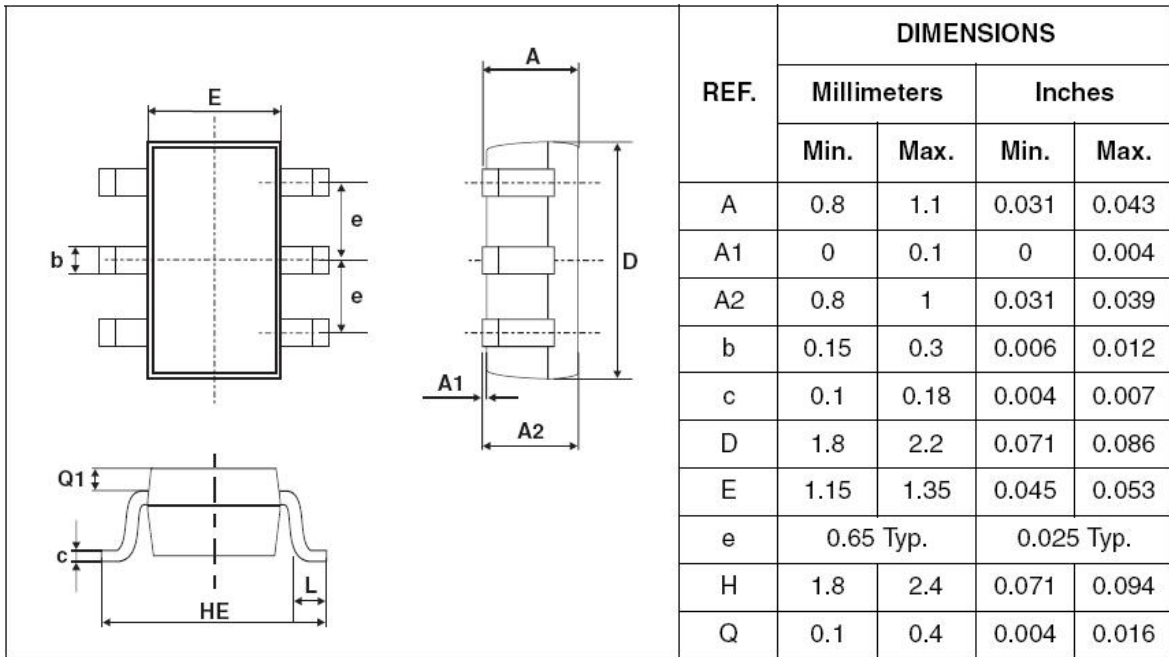

Fig4. Clamping Voltage vs. Peak Pulse Current

SOT-363 Mechanical Data



The SINO-IC logo is a registered trademark of ShangHai Sino-IC Microelectronics Co., Ltd.

© 2005 SINO-IC – Printed in China – All rights reserved.

SHANGHAI SINO-IC MICROELECTRONICS CO., LTD

Add: Building 3, Room 3401-03, No.200 Zhangheng Road, ZhangJiang Hi-Tech Park, Pudong, Shanghai 201203, China

Website: <http://www.sino-ic.net>