

Data sheet | Item number: 2204-1201

2-conductor through terminal block; with push-button; 4 mm<sup>2</sup>; with test port; side and center marking; for DIN-rail 35 x 15 and 35 x 7.5; Push-in CAGE CLAMP®

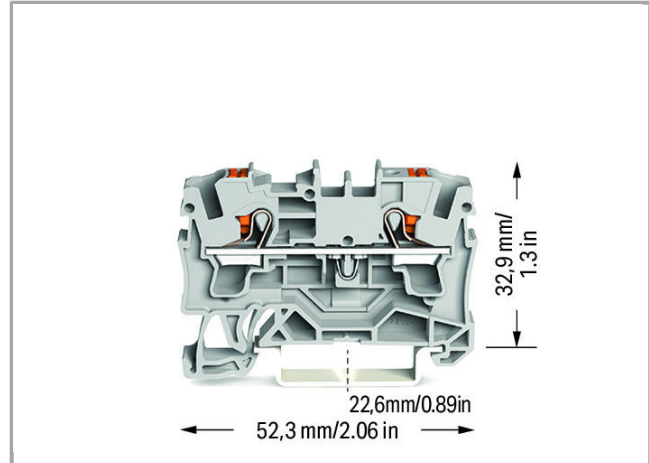

[www.wago.com/2204-1201](http://www.wago.com/2204-1201)

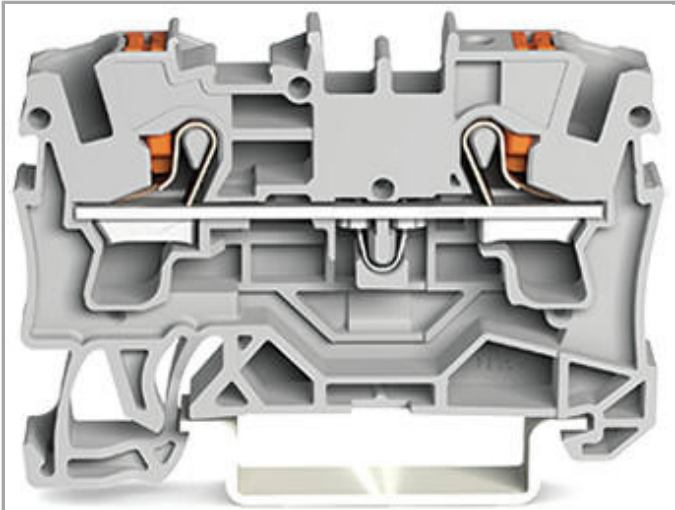

RoHS  Compliant

BOMcheck.net

Color: ■

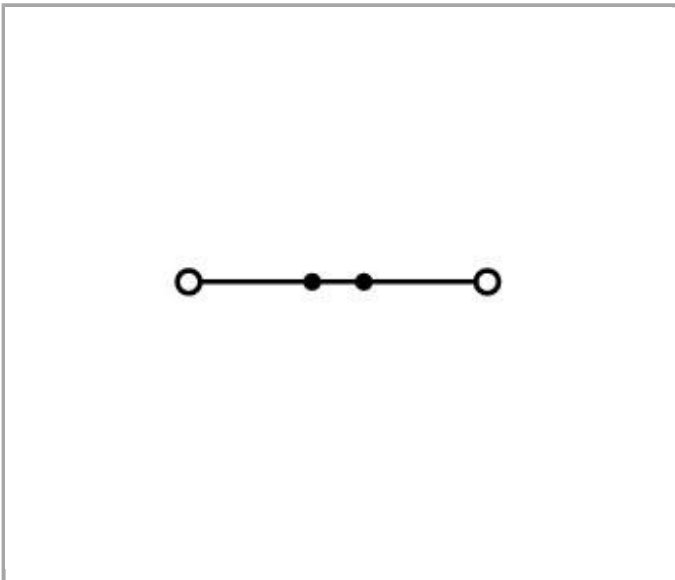

Data  
Electrical data

### Ratings per IEC/EN 60664-1

Rated voltage (III / 3)	800 V
Rated impulse voltage (III / 3)	8 kV
Rated current	32 A
Rated current (2)	41 A

### Approvals per UL 1059

Rated voltage UL (Use Group B)	600 V
Rated current UL (Use Group B)	30 A
Rated voltage UL (Use Group C)	600 V
Rated current UL (Use Group C)	30 A

### Connection data

Connection technology	Push-in CAGE CLAMP®
Actuation type	Push-in Push-button
Connectable conductor materials	Copper
Nominal cross section	4 mm <sup>2</sup>
Solid conductor	0.5 ... 6 mm <sup>2</sup> / 20 ... 10 AWG
Solid conductor, push-in termination	1 ... 6 mm <sup>2</sup> / 14 ... 10 AWG
Fine-stranded conductor	0.5 ... 6 mm <sup>2</sup> / 20 ... 10 AWG
Strip length	11 ... 13 mm / 0.43 ... 0.51 inch
Total number of connection points	2
Total number of potentials	1
Number of levels	1
Type of wiring	Front-entry wiring

### Geometrical Data

Width	6.2 mm / 0.244 inch
Height from upper-edge of DIN-35 rail	32.9 mm / 1.295 inch
Depth	52.3 mm / 2.059 inch

### Mechanical data

Design	horizontal
Type of mounting	DIN-35 rail
Marking level	Center/side marking

## Material Data



Color	gray
Insulating material	Polyamide 66 (PA 66)
Fire load	0.137 MJ
Weight	7.239 g

## Commercial data



Country of origin	DE
GTIN	4055143711494

## Approvals / Certificates



### Ex-Approvals

Logo	Approval	Additional Approval Text	Certificate name
	AEx Underwriters Laboratories Inc.	UL 60079	4788360975
	ATEX Physikalisch Technische Bundesanstalt	IEC 60079-0	PTB 18 ATEX 1006 U
	IECEX Physikalisch Technische Bundesanstalt	IEC 60079	IECEX PTB 18.00 13U (Ex eb IIC Gb and Ex eb I Mb)

### Country specific Approvals











Logo	Approval	Additional Approval Text	Certificate name
	CCA DEKRA Certification B.V.	EN 60947	NTR NL 7666
	CSA DEKRA Certification B.V.	C22.2	70175102
	KEMA/KEUR DEKRA Certification B.V.	EN 60947	71- 102877

### UL-Approvals



Logo	Approval	Additional Approval Text	Certificate name
	cURus Underwriters Laboratories Inc.	UL 1059	4788360975
	UL Underwriters Laboratories Inc.	UL 1059	4788360975

## Compatible products

### Insulation stop

















	<b>Item no.: 2004-171</b> Insulation stop; 0.25 - 0.5 mm²; 5 pieces/strip	<a href="http://www.wago.com/2004-171">www.wago.com/2004-171</a>
	<b>Item no.: 2004-172</b> Insulation stop; 0.75 - 1 mm²; 5 pieces/strip	<a href="http://www.wago.com/2004-172">www.wago.com/2004-172</a>
<b>check</b>		
	<b>Item no.: 2004-511</b> Modular TOPJOB®S connector; modular; for jumper contact slot; 1-pole	<a href="http://www.wago.com/2004-511">www.wago.com/2004-511</a>
	<b>Item no.: 2004-549</b> Spacer module; modular; e.g., for bridging commoned terminal blocks	<a href="http://www.wago.com/2004-549">www.wago.com/2004-549</a>
	<b>Item no.: 2004-552</b> Modular TOPJOB®S connector; modular; for jumper contact slot; 2-pole	<a href="http://www.wago.com/2004-552">www.wago.com/2004-552</a>
	<b>Item no.: 2004-553</b> Modular TOPJOB®S connector; modular; for jumper contact slot; 3-pole	<a href="http://www.wago.com/2004-553">www.wago.com/2004-553</a>
	<b>Item no.: 2004-554</b> Modular TOPJOB®S connector; modular; for jumper contact slot; 4-pole	<a href="http://www.wago.com/2004-554">www.wago.com/2004-554</a>
	<b>Item no.: 2004-555</b> Modular TOPJOB®S connector; modular; for jumper contact slot; 5-pole	<a href="http://www.wago.com/2004-555">www.wago.com/2004-555</a>
	<b>Item no.: 2009-174</b> Test plug adapter; for 4 mm Ø test plugs; for testing TOPJOB®S rail-mounted terminal blocks	<a href="http://www.wago.com/2009-174">www.wago.com/2009-174</a>
	<b>Item no.: 2009-182</b> Testing tap; for max. 2.5 mm²; tool-free connection for individual test wires 0.08 - 2.5 mm	<a href="http://www.wago.com/2009-182">www.wago.com/2009-182</a>

### Carrier rail

	<b>Item no.: 210-112</b> Steel carrier rail; 35 x 7.5 mm; 1 mm thick; 2 m long; slotted; according to EN 60715; "Hole width 25 mm	<a href="http://www.wago.com/210-112">www.wago.com/210-112</a>
	<b>Item no.: 210-113</b> Steel carrier rail; 35 x 7.5 mm; 1 mm thick; 2 m long; unslotted; according to EN 60715	<a href="http://www.wago.com/210-113">www.wago.com/210-113</a>
	<b>Item no.: 210-114</b> Steel carrier rail; 35 x 15 mm; 1.5 mm thick; 2 m long; unslotted; similar to EN 60715	<a href="http://www.wago.com/210-114">www.wago.com/210-114</a>
	<b>Item no.: 210-115</b> Steel carrier rail; 35 x 7.5 mm; 1 mm thick; 2 m long; slotted; according to EN 60715; "Hole width 18 mm	<a href="http://www.wago.com/210-115">www.wago.com/210-115</a>
	<b>Item no.: 210-118</b> Steel carrier rail; 35 x 15 mm; 2.3 mm thick; 2 m long; unslotted; according to EN 60715	<a href="http://www.wago.com/210-118">www.wago.com/210-118</a>
	<b>Item no.: 210-196</b> Aluminum carrier rail; 35 x 8.2 mm; 1.6 mm thick; 2 m long; unslotted; similar to EN 60715	<a href="http://www.wago.com/210-196">www.wago.com/210-196</a>
	<b>Item no.: 210-197</b> Steel carrier rail; 35 x 15 mm; 1.5 mm thick; 2 m long; slotted; similar to EN 60715	<a href="http://www.wago.com/210-197">www.wago.com/210-197</a>
	<b>Item no.: 210-198</b> Copper carrier rail; 35 x 15 mm; 2.3 mm thick; 2 m long; unslotted; according to EN 60715	<a href="http://www.wago.com/210-198">www.wago.com/210-198</a>

**Marking accessories**

	<b>Item no.: 2009-110</b> Marking strips; on reel; not stretchable; plain; snap-on type	<a href="http://www.wago.com/2009-110">www.wago.com/2009-110</a>
	<b>Item no.: 2009-115</b> WMB-Inline; for Smart Printer; on reel; stretchable 5 - 5.2 mm; plain; snap-on type	<a href="http://www.wago.com/2009-115">www.wago.com/2009-115</a>
	<b>Item no.: 2009-115/000-002</b> WMB-Inline; for Smart Printer; on reel; stretchable 5 - 5.2 mm; plain; snap-on type	<a href="http://www.wago.com/2009-115/000-002">www.wago.com/2009-115/000-002</a>
	<b>Item no.: 2009-115/000-006</b> WMB-Inline; for smartPRINTER; on reel; stretchable 5 - 5.2 mm; plain; snap-on type	<a href="http://www.wago.com/2009-115/000-006">www.wago.com/2009-115/000-006</a>
	<b>Item no.: 2009-115/000-007</b> WMB-Inline; for Smart Printer; on reel; stretchable 5 - 5.2 mm; plain; snap-on type	<a href="http://www.wago.com/2009-115/000-007">www.wago.com/2009-115/000-007</a>
	<b>Item no.: 2009-115/000-012</b> WMB-Inline; for smartPRINTER; on reel; stretchable 5 - 5.2 mm; plain; snap-on type	<a href="http://www.wago.com/2009-115/000-012">www.wago.com/2009-115/000-012</a>
	<b>Item no.: 2009-115/000-017</b> WMB-Inline; for Smart Printer; on reel; stretchable 5 - 5.2 mm; plain; snap-on type	<a href="http://www.wago.com/2009-115/000-017">www.wago.com/2009-115/000-017</a>
	<b>Item no.: 2009-115/000-023</b> WMB-Inline; for Smart Printer; on reel; stretchable 5 - 5.2 mm; plain; snap-on type	<a href="http://www.wago.com/2009-115/000-023">www.wago.com/2009-115/000-023</a>
	<b>Item no.: 2009-115/000-024</b> WMB-Inline; for smartPRINTER; on reel; stretchable 5 - 5.2 mm; plain; snap-on type	<a href="http://www.wago.com/2009-115/000-024">www.wago.com/2009-115/000-024</a>

	<b>Item no.: 2009-135</b> WMB-Inline; for Smart Printer; on reel; stretchable 5 - 5.2 mm; plain; snap-on type	<a href="http://www.wago.com/2009-135">www.wago.com/2009-135</a>
	<b>Item no.: 2009-145</b> Mini-WSB Inline; for Smart Printer; on reel; stretchable 5 - 5.2 mm; plain; snap-on type	<a href="http://www.wago.com/2009-145">www.wago.com/2009-145</a>
	<b>Item no.: 2009-145/000-002</b> Mini-WSB Inline; for Smart Printer; on reel; stretchable 5 - 5.2 mm; plain; snap-on type	<a href="http://www.wago.com/2009-145/000-002">www.wago.com/2009-145/000-002</a>
	<b>Item no.: 2009-145/000-005</b> Mini-WSB Inline; for Smart Printer; on reel; stretchable 5 - 5.2 mm; plain; snap-on type	<a href="http://www.wago.com/2009-145/000-005">www.wago.com/2009-145/000-005</a>
	<b>Item no.: 2009-145/000-006</b> Mini-WSB Inline; for Smart Printer; on reel; stretchable 5 - 5.2 mm; plain; snap-on type	<a href="http://www.wago.com/2009-145/000-006">www.wago.com/2009-145/000-006</a>
	<b>Item no.: 2009-145/000-007</b> Mini-WSB Inline; for Smart Printer; on reel; stretchable 5 - 5.2 mm; plain; snap-on type	<a href="http://www.wago.com/2009-145/000-007">www.wago.com/2009-145/000-007</a>
	<b>Item no.: 2009-145/000-012</b> Mini-WSB Inline; for Smart Printer; on reel; stretchable 5 - 5.2 mm; plain; snap-on type	<a href="http://www.wago.com/2009-145/000-012">www.wago.com/2009-145/000-012</a>
	<b>Item no.: 2009-145/000-023</b> Mini-WSB Inline; for smartPRINTER; on reel; stretchable 5 - 5.2 mm; plain; snap-on type	<a href="http://www.wago.com/2009-145/000-023">www.wago.com/2009-145/000-023</a>
	<b>Item no.: 2009-145/000-024</b> Mini-WSB Inline; for Smart Printer; on reel; stretchable 5 - 5.2 mm; plain; snap-on type	<a href="http://www.wago.com/2009-145/000-024">www.wago.com/2009-145/000-024</a>
	<b>Item no.: 2009-191</b> Group marker carrier	<a href="http://www.wago.com/2009-191">www.wago.com/2009-191</a>
	<b>Item no.: 2009-192</b> Group marker carrier	<a href="http://www.wago.com/2009-192">www.wago.com/2009-192</a>
	<b>Item no.: 2009-193</b> Group marker carrier	<a href="http://www.wago.com/2009-193">www.wago.com/2009-193</a>
	<b>Item no.: 2009-198</b> Adaptor	<a href="http://www.wago.com/2009-198">www.wago.com/2009-198</a>
	<b>Item no.: 248-501</b> Miniature WSB Quick marking system; plain; Marker width 5 mm; 10 strips with 10 markers per card	<a href="http://www.wago.com/248-501">www.wago.com/248-501</a>
	<b>Item no.: 248-501/000-002</b> Mini-WSB marking card; as card; not stretchable; plain; snap-on type	<a href="http://www.wago.com/248-501/000-002">www.wago.com/248-501/000-002</a>
	<b>Item no.: 248-501/000-005</b> Mini-WSB marking card; as card; not stretchable; plain; snap-on type	<a href="http://www.wago.com/248-501/000-005">www.wago.com/248-501/000-005</a>



**Item no.: 248-501/000-006**  
Mini-WSB marking card; as card; not stretchable; plain; snap-on type

[www.wago.com/248-501/000-006](http://www.wago.com/248-501/000-006)



**Item no.: 248-501/000-007**  
Mini-WSB marking card; as card; not stretchable; plain; snap-on type

[www.wago.com/248-501/000-007](http://www.wago.com/248-501/000-007)



**Item no.: 248-501/000-012**  
Mini-WSB marking card; as card; not stretchable; plain; snap-on type

[www.wago.com/248-501/000-012](http://www.wago.com/248-501/000-012)



**Item no.: 248-501/000-017**  
Mini-WSB marking card; as card; not stretchable; plain; snap-on type

[www.wago.com/248-501/000-017](http://www.wago.com/248-501/000-017)



**Item no.: 248-501/000-023**  
Mini-WSB marking card; as card; not stretchable; plain; snap-on type

[www.wago.com/248-501/000-023](http://www.wago.com/248-501/000-023)



**Item no.: 248-501/000-024**  
Mini-WSB marking card; as card; not stretchable; plain; snap-on type

[www.wago.com/248-501/000-024](http://www.wago.com/248-501/000-024)



**Item no.: 793-501**  
WMB marking card; as card; not stretchable; plain; snap-on type

[www.wago.com/793-501](http://www.wago.com/793-501)



**Item no.: 793-501/000-002**  
WMB marking card; as card; not stretchable; plain; snap-on type

[www.wago.com/793-501/000-002](http://www.wago.com/793-501/000-002)



**Item no.: 793-501/000-005**  
WMB marking card; as card; not stretchable; plain; snap-on type

[www.wago.com/793-501/000-005](http://www.wago.com/793-501/000-005)



**Item no.: 793-501/000-006**  
WMB marking card; as card; not stretchable; plain; snap-on type

[www.wago.com/793-501/000-006](http://www.wago.com/793-501/000-006)



**Item no.: 793-501/000-007**  
WMB marking card; as card; not stretchable; plain; snap-on type

[www.wago.com/793-501/000-007](http://www.wago.com/793-501/000-007)



**Item no.: 793-501/000-012**  
WMB marking card; as card; not stretchable; plain; snap-on type

[www.wago.com/793-501/000-012](http://www.wago.com/793-501/000-012)



**Item no.: 793-501/000-017**  
WMB marking card; as card; not stretchable; plain; snap-on type

[www.wago.com/793-501/000-017](http://www.wago.com/793-501/000-017)

















**Item no.: 793-501/000-023**  
WMB marking card; as card; not stretchable; plain; snap-on type

[www.wago.com/793-501/000-023](http://www.wago.com/793-501/000-023)































**Item no.: 793-501/000-024**  
WMB marking card; as card; not stretchable; plain; snap-on type

[www.wago.com/793-501/000-024](http://www.wago.com/793-501/000-024)

	<b>Item no.: 793-5501</b> WMB marking card; as card; for terminal block width 5 - 17.5 mm; stretchable 5 - 5.2 mm; plain; snap-on type	<a href="http://www.wago.com/793-5501">www.wago.com/793-5501</a>
	<b>Item no.: 793-5501/000-002</b> WMB marking card; as card; for terminal block width 5 - 17.5 mm; stretchable 5 - 5.2 mm; plain; snap-on type	<a href="http://www.wago.com/793-5501/000-002">www.wago.com/793-5501/000-002</a>
	<b>Item no.: 793-5501/000-005</b> WMB marking card; as card; stretchable 5 - 5.2 mm; plain; snap-on type	<a href="http://www.wago.com/793-5501/000-005">www.wago.com/793-5501/000-005</a>
	<b>Item no.: 793-5501/000-006</b> WMB marking card; as card; stretchable 5 - 5.2 mm; plain; snap-on type	<a href="http://www.wago.com/793-5501/000-006">www.wago.com/793-5501/000-006</a>
	<b>Item no.: 793-5501/000-007</b> WMB marking card; as card; stretchable 5 - 5.2 mm; plain; snap-on type	<a href="http://www.wago.com/793-5501/000-007">www.wago.com/793-5501/000-007</a>
	<b>Item no.: 793-5501/000-012</b> WMB marking card; as card; stretchable 5 - 5.2 mm; plain; snap-on type	<a href="http://www.wago.com/793-5501/000-012">www.wago.com/793-5501/000-012</a>
	<b>Item no.: 793-5501/000-017</b> WMB marking card; as card; stretchable 5 - 5.2 mm; plain; snap-on type	<a href="http://www.wago.com/793-5501/000-017">www.wago.com/793-5501/000-017</a>
	<b>Item no.: 793-5501/000-023</b> WMB marking card; as card; stretchable 5 - 5.2 mm; plain; snap-on type	<a href="http://www.wago.com/793-5501/000-023">www.wago.com/793-5501/000-023</a>
	<b>Item no.: 793-5501/000-024</b> WMB marking card; as card; stretchable 5 - 5.2 mm; plain; snap-on type	<a href="http://www.wago.com/793-5501/000-024">www.wago.com/793-5501/000-024</a>
<b>ferrule</b>		
	<b>Item no.: 216-262</b> Ferrule; Sleeve for 0.75 mm <sup>2</sup> / 18 AWG; insulated; electro-tin plated; electrolytic copper; gastight crimped; acc. to DIN 46228, Part 4/09.90	<a href="http://www.wago.com/216-262">www.wago.com/216-262</a>
	<b>Item no.: 216-263</b> Ferrule; Sleeve for 1 mm <sup>2</sup> / AWG 18; insulated; electro-tin plated; electrolytic copper; gastight crimped; acc. to DIN 46228, Part 4/09.90	<a href="http://www.wago.com/216-263">www.wago.com/216-263</a>
	<b>Item no.: 216-264</b> Ferrule; Sleeve for 1.5 mm <sup>2</sup> / AWG 16; insulated; electro-tin plated; electrolytic copper; gastight crimped; acc. to DIN 46228, Part 4/09.90	<a href="http://www.wago.com/216-264">www.wago.com/216-264</a>
	<b>Item no.: 216-266</b> Ferrule; Sleeve for 2.5 mm <sup>2</sup> / AWG 14; insulated; electro-tin plated; electrolytic copper; gastight crimped; acc. to DIN 46228, Part 4/09.90	<a href="http://www.wago.com/216-266">www.wago.com/216-266</a>
	<b>Item no.: 216-267</b> Ferrule; Sleeve for 4 mm <sup>2</sup> / AWG 12; insulated; electro-tin plated; electrolytic copper; gastight crimped; acc. to DIN 46228, Part 4/09.90	<a href="http://www.wago.com/216-267">www.wago.com/216-267</a>
<b>End plate</b>		
	<b>Item no.: 2004-1291</b> End and intermediate plate; 1 mm thick	<a href="http://www.wago.com/2004-1291">www.wago.com/2004-1291</a>



	<b>Item no.: 2004-1292</b> End and intermediate plate; 1 mm thick	<a href="http://www.wago.com/2004-1292">www.wago.com/2004-1292</a>
	<b>Item no.: 2004-1293</b> Separator plate; 2 mm thick; oversized	<a href="http://www.wago.com/2004-1293">www.wago.com/2004-1293</a>
	<b>Item no.: 2004-1294</b> Separator plate; 2 mm thick; oversized	<a href="http://www.wago.com/2004-1294">www.wago.com/2004-1294</a>
<b>Jumper</b>		
	<b>Item no.: 2004-402</b> Push-in type jumper bar; insulated; 2-way; Nominal current 32 A	<a href="http://www.wago.com/2004-402">www.wago.com/2004-402</a>
	<b>Item no.: 2004-403</b> Push-in type jumper bar; insulated; 3-way; Nominal current 32 A	<a href="http://www.wago.com/2004-403">www.wago.com/2004-403</a>
	<b>Item no.: 2004-404</b> Push-in type jumper bar; insulated; 4-way; Nominal current 32 A	<a href="http://www.wago.com/2004-404">www.wago.com/2004-404</a>
	<b>Item no.: 2004-405</b> Push-in type jumper bar; insulated; 5-way; Nominal current 32 A	<a href="http://www.wago.com/2004-405">www.wago.com/2004-405</a>
	<b>Item no.: 2004-405/011-000</b> Star point jumper; insulated; 3-way (1-3-5); IN = IN terminal block	<a href="http://www.wago.com/2004-405/011-000">www.wago.com/2004-405/011-000</a>
	<b>Item no.: 2004-406</b> Push-in type jumper bar; insulated; 6-way; Nominal current 32 A	<a href="http://www.wago.com/2004-406">www.wago.com/2004-406</a>
	<b>Item no.: 2004-406/020-000</b> Delta jumper; insulated; 1-2 3-4 5-6; IN = IN terminal block	<a href="http://www.wago.com/2004-406/020-000">www.wago.com/2004-406/020-000</a>
	<b>Item no.: 2004-407</b> Push-in type jumper bar; insulated; 7-way; Nominal current 32 A	<a href="http://www.wago.com/2004-407">www.wago.com/2004-407</a>
	<b>Item no.: 2004-408</b> Push-in type jumper bar; insulated; 8-way; Nominal current 32 A	<a href="http://www.wago.com/2004-408">www.wago.com/2004-408</a>
	<b>Item no.: 2004-409</b> Push-in type jumper bar; insulated; 9-way; Nominal current 32 A	<a href="http://www.wago.com/2004-409">www.wago.com/2004-409</a>
	<b>Item no.: 2004-410</b> Push-in type jumper bar; insulated; 10-way; Nominal current 32 A	<a href="http://www.wago.com/2004-410">www.wago.com/2004-410</a>
	<b>Item no.: 2004-433</b> Push-in type jumper bar; insulated; from 1 to 3; Nominal current 32 A	<a href="http://www.wago.com/2004-433">www.wago.com/2004-433</a>
	<b>Item no.: 2004-434</b> Push-in type jumper bar; insulated; from 1 to 4; Nominal current 32 A	<a href="http://www.wago.com/2004-434">www.wago.com/2004-434</a>
	<b>Item no.: 2004-435</b> Push-in type jumper bar; insulated; from 1 to 5; Nominal current 32 A	<a href="http://www.wago.com/2004-435">www.wago.com/2004-435</a>
	<b>Item no.: 2004-436</b> Push-in type jumper bar; insulated; from 1 to 6; Nominal current 32 A	<a href="http://www.wago.com/2004-436">www.wago.com/2004-436</a>
	<b>Item no.: 2004-437</b> Push-in type jumper bar; insulated; from 1 to 7; Nominal current 32 A	<a href="http://www.wago.com/2004-437">www.wago.com/2004-437</a>

	<b>Item no.: 2004-438</b> Push-in type jumper bar; insulated; from 1 to 8; Nominal current 32 A	<a href="http://www.wago.com/2004-438">www.wago.com/2004-438</a>
	<b>Item no.: 2004-439</b> Push-in type jumper bar; insulated; from 1 to 9; Nominal current 32 A	<a href="http://www.wago.com/2004-439">www.wago.com/2004-439</a>
	<b>Item no.: 2004-440</b> Push-in type jumper bar; insulated; from 1 to 10; Nominal current 32 A	<a href="http://www.wago.com/2004-440">www.wago.com/2004-440</a>
	<b>Item no.: 2006-499</b> Step-down jumper; insulated; from 6/4 mm <sup>2</sup> to 4/2.5/1.5 mm <sup>2</sup> ; Nominal current 32 A	<a href="http://www.wago.com/2006-499">www.wago.com/2006-499</a>
	<b>Item no.: 2016-499</b> Step-down jumper; insulated; from 16/10 mm <sup>2</sup> to 10/6/4/2.5 mm <sup>2</sup> ; Nominal current 57 A	<a href="http://www.wago.com/2016-499">www.wago.com/2016-499</a>
	<b>Item no.: 210-103</b> Wire commoning chain; insulated; 50 connections	<a href="http://www.wago.com/210-103">www.wago.com/210-103</a>
	<b>Item no.: 210-123</b> Wire commoning chain; insulated; 50 connections	<a href="http://www.wago.com/210-123">www.wago.com/210-123</a>
<b>tools</b>		
	<b>Item no.: 210-658</b> Operating tool with partially insulated shaft; Blade (3.5 x 0.5) mm; short; angled	<a href="http://www.wago.com/210-658">www.wago.com/210-658</a>
	<b>Item no.: 210-720</b> Operating tool with partially insulated shaft; Type 2, blade (3.5 x 0.5) mm	<a href="http://www.wago.com/210-720">www.wago.com/210-720</a>

## Downloads

### CAD/CAE - Smart Data

#### CAD data

3D Download 2204-1201	URL	Download
-----------------------	-----	----------

Subject to changes.