



**Please note that Cypress is an Infineon Technologies Company.**

The document following this cover page is marked as “Cypress” document as this is the company that originally developed the product. Please note that Infineon will continue to offer the product to new and existing customers as part of the Infineon product portfolio.

**Continuity of document content**

The fact that Infineon offers the following product as part of the Infineon product portfolio does not lead to any changes to this document. Future revisions will occur when appropriate, and any changes will be set out on the document history page.

**Continuity of ordering part numbers**

Infineon continues to support existing part numbers. Please continue to use the ordering part numbers listed in the datasheet for ordering.

# EZ-USB HX2LP™

## Low-Power USB 2.0 Hub Controller Family

### Features

- USB 2.0 hub controller
  - Automotive and Industrial grade option (−40 °C to 85 °C)
  - Compliant with USB 2.0 specification
  - USB-IF certified: TID# 30000009
  - Windows Hardware Quality Lab (WHQL) Compliant
  - Up to four downstream ports supported
  - Supports bus powered and self powered modes
  - Single transaction translator (TT)
  - Bus power configurations
  - Fit, form, and function compatible with CY7C65640 and CY7C65640A (TetraHub™)
  - Space saving 56-pin QFN
  - Single power supply requirement
    - Internal regulator for reduced cost
  - Integrated upstream pull-up resistor
  - Integrated pull-down resistors for all downstream ports
  - Integrated upstream and downstream termination resistors
  - Integrated port status indicator control
- 24 MHz external crystal (integrated phase-locked loop (PLL))
  - In-system EEPROM programming
  - Configurable with external SPI EEPROM:
    - Vendor ID, Product ID, Device ID (VID/PID/DID)
    - Number of active ports
    - Number of removable ports
    - Maximum power setting for high-speed and full-speed
    - Hub controller power setting
    - Power-on timer
    - Overcurrent detection mode
    - Enabled and disabled overcurrent timer
    - Overcurrent pin polarity
    - Indicator pin polarity
    - Compound device
    - Enable full-speed only
    - Disable port indicators
    - Ganged power switching
    - Self and bus powered compatibility
    - Fully configurable string descriptors for multiple language support

### Functional Description

For a complete list of related documentation, click [here](#).

### Block Diagram – CY7C65630

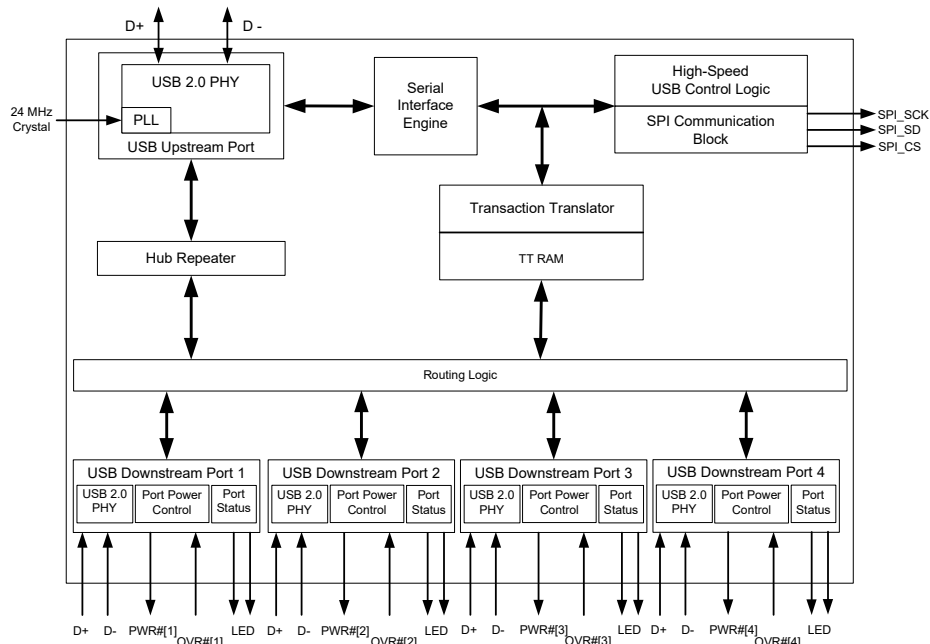

**Errata:** For information on silicon errata, see [Errata on page 28](#). Details include trigger conditions, devices affected, and proposed workaround.

### Block Diagram – CY7C65620

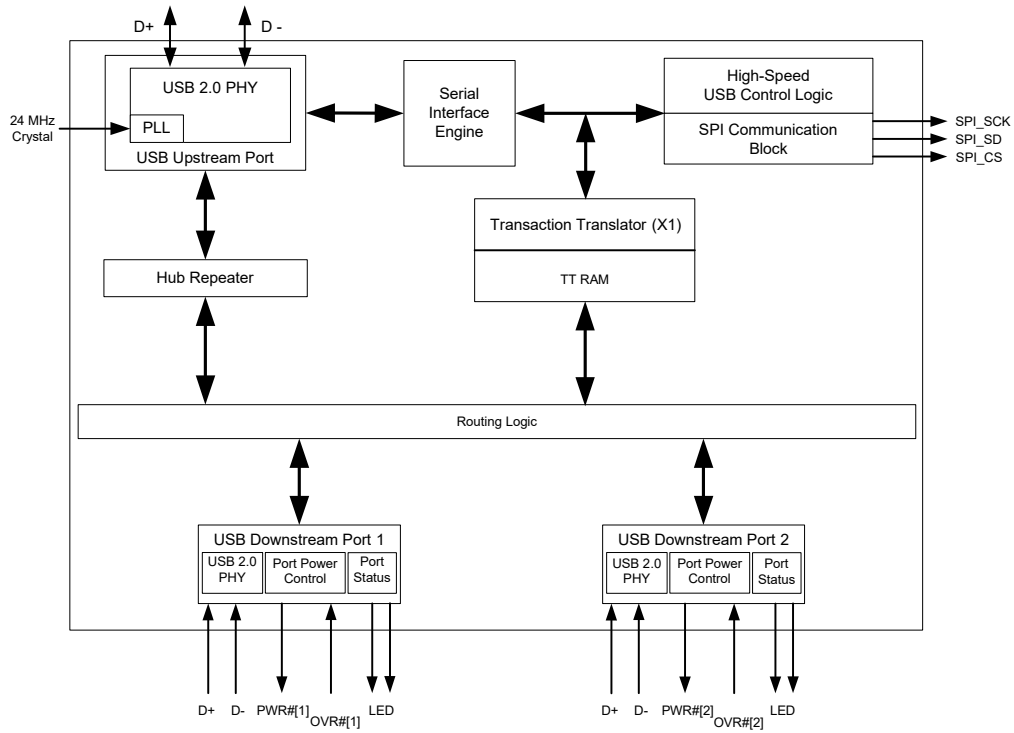

## More Information

Cypress provides a wealth of data at [www.cypress.com](http://www.cypress.com) to help you to select the right <product> device for your design, and to help you to quickly and effectively integrate the device into your design. For a comprehensive list of resources, see the knowledge base article <http://www.cypress.com/products/hx2lp>.

- Overview: [USB Portfolio](#), [USB Roadmap](#)
- USB 2.0 Product Selectors: [HX2LP](#), [HX2VL](#)
- Application notes: Cypress offers a large number of USB application notes covering a broad range of topics, from basic to advanced level. Recommended application notes for getting started with HX2LP are:
  - [AN49150 - Schematic and Layout Review Checklist for HX2LP](#)
  - [AN5044 - EZ-USB Hubs\(CY7C656XX\) PCB Design Recommendations](#)
  - [AN15454 - Bus-Powered USB Hub Design Using EZ-USB HX2LP™/HX2VL](#)
  - [AN61904 - How HX2LP™ Addresses Byte and Word-Addressable SPI EEPROMs](#)
  - [AN69235 - Migrating from HX2/HX2LP to HX2VL](#)
- Reference Designs:
  - [CY4605 - High-Speed Low-Power USB 2.0 Compliant 2-Port Hub](#)
  - [CY4606 - EZ-USB HX2LP High-Speed Low-Power USB 2.0 Compliant 4-Port Hub](#)
- Models: [HX2LP](#)

### EZ-USB® HX2LP™ Reference Design Kit (RDK)

EZ-USB® HX2LP™ Reference Design Kit (RDK) board is a tool to demonstrate the features of EZ-USB HX2LP devices (CY7C65620/CY7C65630). Both CY7C65620 and CY7C65630 are identical in every aspect except for the number of ports they support. The HX2LP RDK is based on the 56-pin QFN for CY7C65620/CY7C65630. Both are single transaction translator (1TT) hubs. In the initial phase of the design, this board helps developers to understand the chip features and limitations before proceeding with a complete design. The RDK includes support documents related to board hardware, PC application software, and EEPROM configuration data (.iic) files.

## Contents

<b>Introduction</b> .....	<b>5</b>	<b>Upstream USB Connection</b> .....	<b>21</b>
USB Serial Interface Engine .....	5	<b>Downstream USB Connection</b> .....	<b>21</b>
Hub Repeater .....	5	<b>LED Connection</b> .....	<b>21</b>
Transaction Translator .....	5	<b>System Block Diagram</b> .....	<b>22</b>
<b>Applications</b> .....	<b>5</b>	<b>Absolute Maximum Ratings</b> .....	<b>23</b>
<b>Functional Overview</b> .....	<b>5</b>	<b>Operating Conditions</b> .....	<b>23</b>
System Initialization .....	5	<b>Electrical Characteristics</b> .....	<b>23</b>
Enumeration .....	5	DC Electrical Characteristics .....	23
Downstream Ports .....	6	USB Transceiver .....	23
Upstream Port .....	6	AC Electrical Characteristics .....	24
Power Switching .....	6	<b>Ordering Information</b> .....	<b>25</b>
Overcurrent Detection .....	6	Ordering Code Definitions .....	25
Port Indicators .....	6	<b>Package Diagrams</b> .....	<b>26</b>
<b>Pin Configuration</b> .....	<b>8</b>	Thermal Impedance for the Package .....	26
<b>Pin Definitions</b> .....	<b>9</b>	<b>Acronyms</b> .....	<b>27</b>
<b>Default Descriptors</b> .....	<b>11</b>	<b>Document Conventions</b> .....	<b>27</b>
Device Descriptor .....	11	Units of Measure .....	27
Configuration Descriptor .....	11	Numeric Naming .....	27
Interface Descriptor .....	12	<b>Errata</b> .....	<b>28</b>
Endpoint Descriptor .....	12	Part Numbers Affected .....	28
Device Qualifier Descriptor .....	12	HX2LP Qualification Status .....	28
Hub Descriptor .....	13	HX2LP Errata Summary .....	28
<b>Configuration Options</b> .....	<b>14</b>	<b>Document History Page</b> .....	<b>29</b>
0xD0 Load .....	14	<b>Sales, Solutions, and Legal Information</b> .....	<b>34</b>
0xD2 Load .....	14	Worldwide Sales and Design Support .....	34
0xD4 Load .....	15	Products .....	34
<b>Supported USB Requests</b> .....	<b>18</b>	PSoC® Solutions .....	34
Device Class Commands .....	18	Cypress Developer Community .....	34
Hub Class Commands .....	19	Technical Support .....	34

## Introduction

EZ-USB HX2LP™ is Cypress's next generation family of high-performance, low-power USB 2.0 hub controllers. HX2LP is an ultra low power single chip USB 2.0 hub controller with integrated upstream and downstream transceivers, a USB serial interface engine (SIE), USB hub control and repeater logic, and TT logic. Cypress has also integrated many of the external passive components, such as pull-up and pull-down resistors, reducing the overall bill of materials required to implement a hub design. The HX2LP portfolio consists of:

- **CY7C65630: 4-port/single transaction translator**

This device option is for ultra low-power applications that require four downstream ports. All four ports share a single transaction translator. The CY7C65630 is available in 56 QFN and is also pin-for-pin compatible with the CY7C65640.

- **CY7C65620: 2-port/single transaction translator**

This device option is for a 2-port bus powered application. Both ports share a single transaction translator. The CY7C65620 is available in a 56 QFN.

All device options are supported by Cypress's world class reference design kits, which include board schematics, bill of materials, Gerber files, Orcad files, and thorough design documentation.

## USB Serial Interface Engine

The serial interface engine (SIE) allows the CY7C65620/CY7C65630 to communicate with the USB host. The SIE handles the following USB activities independently of the Hub Control Block.

- Bit stuffing and unstuffing
- Checksum generation and checking
- TOKEN type identification
- Address checking.

## Hub Repeater

The hub repeater manages the connectivity between upstream and downstream facing ports that are operating at the same speed. It supports full- or low-speed connectivity and high-speed connectivity. According to the USB 2.0 specification, the HUB Repeater provides the following functions:

- Sets up and tears down connectivity on packet boundaries
- Ensures orderly entry into and out of the suspend state, including proper handling of remote wakeups.

## Transaction Translator

The TT translates data from one speed to another. A TT takes high speed split transactions and translates them to full- or low-speed transactions when the hub is operating at high-speed (the upstream port is connected to a high-speed host controller) and has full- or low-speed devices attached. The operating speed of a device attached on a downstream facing port determines whether the routing logic connects a port to the TT or hub repeater. If a full- or low-speed device is connected to the hub operating at high-speed, the data transfer route includes the TT. If a high-speed device is connected to this high-speed hub,

the route only includes the repeater and no TT, because the device and the hub are operating at the same speed. When the hub is operating at full-speed (the upstream port is connected to a full-speed host controller), a high-speed peripheral does not operate at its full capability. These devices only work at full-speed. Full- and low-speed devices connected to this hub operate at their normal speed.

## Applications

Typical applications for the HX2LP device family are:

- Standalone hubs
- Motherboard hubs
- Monitor hubs
- Advanced port replicators
- Docking stations
- Split-PC designs
- External personal storage drives
- Keyboard hubs

## Functional Overview

The Cypress CY7C65620/CY7C65630 USB 2.0 Hubs are high-performance, low system cost solutions for USB. The CY7C65620/CY7C65630 USB 2.0 Hubs integrate 1.5 k $\Omega$  upstream pull-up resistors for full-speed operation and all downstream 15 k $\Omega$  pull-down resistors and series termination resistors on all upstream and downstream D+ and D- pins. This results in optimization of system costs by providing built-in support for the USB 2.0 specification.

## System Initialization

On power-up, the CY7C65620/CY7C65630 reads an external SPI EEPROM for configuration information. At the most basic level, this EEPROM has the vendor ID (VID), product ID (PID), and device ID (DID) for the customer's application. For more specialized applications, other configuration options can be specified. See [Configuration Options on page 14](#) for more details.

After reading the EEPROM, if VBUSPOWER (connected to upstream V<sub>BUS</sub>) is high, CY7C65620/CY7C65630 enables the pull-up resistor on D+ to indicate its presence to the upstream hub, after which a USB bus reset is expected. During this reset, CY7C65620/CY7C65630 initiates a chirp to indicate that it is a high-speed peripheral. In a USB 2.0 system, the upstream hub responds with a chirp sequence, and CY7C65620/CY7C65630 is in a high-speed mode, with the upstream D+ pull-up resistor turned off. In USB 1.x systems, no such chirp sequence from the upstream hub is seen, and CY7C65620/CY7C65630 operates as a normal 1.x hub (operating at full-speed).

## Enumeration

After a USB bus reset, CY7C65620/CY7C65630 is in an unaddressed, unconfigured state (configuration value set to '0'). During the enumeration process, the host sets the hub's address and configuration. After the hub is configured, the full hub functionality is available.

## Downstream Ports

The CY7C65620/CY7C65630 supports a maximum of four downstream ports, each of which may be marked as usable or removable in the extended configuration (0xD2 EEPROM load or 0xD4 EEPROM load, see [Configuration Options on page 14](#). Downstream D+ and D– pull-down resistors are incorporated in CY7C65620/CY7C65630 for each port. Before the hubs are configured, the ports are driven SE0 (single ended zero, where both D+ and D– are driven low) and are set to the unpowered state. When the hub is configured, the ports are not driven and the host may power the ports by sending a SetPortPower command for each port. After a port is powered, any connect or disconnect event is detected by the hub. Any change in the port state is reported by the hubs back to the host through the status change endpoint (endpoint 1). On receipt of SetPortReset request for a port with a device connected, the hub does as follows:

- Performs a USB reset on the corresponding port
- Puts the port in an enabled state
- Enables the green port indicator for that port (if not previously overridden by the host)
- Enables babble detection after the port is enabled.

Babble consists of a non-idle condition on the port after EOF2. If babble is detected on an enabled port, that port is disabled. A ClearPortEnable request from the host also disables the specified port.

Downstream ports can be individually suspended by the host with the SetPortSuspend request. If the hub is not suspended, a remote wakeup event on that port is reflected to the host through a port change indication in the hub status change endpoint. If the hub is suspended, a remote wakeup event on this port is forwarded to the host. The host may resume the port by sending a ClearPortSuspend command.

## Upstream Port

The upstream port includes the transmitter and the receiver state machine. The transmitter and receiver operate in high-speed and full-speed depending on the current hub configuration.

The transmitter state machine monitors the upstream facing port while the hub repeater has connectivity in the upstream direction. This machine prevents babble and disconnect events on the downstream facing ports of this hub from propagating and causing the hub to be disabled or disconnected by the hub to which it is attached.

## Power Switching

The CY7C65620/CY7C65630 includes interface signals for external port power switches. Both ganged and individual (per-port) configurations are supported, with individual switching being the default. Initially all ports are unpowered. After enumerating, the host may power each port by sending a SetPortPower request for that port. The power switching and overcurrent detection of downstream ports is managed by control pins connected to an external power switch device. PWR

[n]# output pins of the CY7C65620/CY7C65630 series are connected to the respective external power switch's port power enable signals. Note that each port power output pin of the external power switch must be bypassed with an electrolytic or tantalum capacitor as required by the USB specification. These capacitors supply the inrush currents, which occur during downstream device hot-attach events. The polarity of this pin is configured through the EEPROM; see [Configuration Options on page 14](#).

## Overcurrent Detection

Overcurrent detection includes 8 ms of timed filtering by default. This parameter is configured from the external EEPROM in a range of 0 ms to 15 ms for both enabled ports and disabled ports individually. Detection of overcurrent on downstream ports is managed by control pins connected to an external power switch device.

The OVR[n]# pins of the CY7C65620/CY7C65630 series are connected to the respective external power switch's port overcurrent indication (output) signals. After detecting an overcurrent condition, hub reports overcurrent condition to the host and disables the PWR# output to the external power device. The polarity of the OVR pins can be configured through the EEPROM; see [Configuration Options on page 14](#).

## Port Indicators

The USB 2.0 port indicators are also supported directly by CY7C65620/CY7C65630. According to the specification, each downstream port of the hub optionally supports a status indicator. The presence of indicators for downstream facing ports is specified by bit 7 of the wHubCharacteristics field of the hub class descriptor. The default CY7C65620/CY7C65630 descriptor specifies that port indicators are supported (wHubCharacteristics, bit 7 is set). If port indicators are not included in the hub, disable this bit through EEPROM settings.

Each port indicator pin is strategically located directly on the opposite edge of the port with which it is associated. A port indicator provides two colors: green and amber. This is usually implemented as two separate LEDs, one amber and the other green. A combination of hardware and software control is used to inform the user of the current status of the port or the device attached to the port and to guide the user through problem resolution. Colors and blinking provide information to the user. The significance of the color of the LED depends on the operational mode of CY7C65620/CY7C65630. The CY7C65620/CY7C65630 port indicators has two modes of operation: automatic and manual.

On power up the CY7C65620/CY7C65630 defaults to automatic mode, where the color of the Port Indicator (green, amber, off) indicates the functional status of the CY7C65620/CY7C65630 port. In automatic mode, the CY7C65620/CY7C65630 turns on the green LED whenever the port is enabled and the amber LED when an overcurrent condition is detected. The color of the port indicator is set by the port state machine. Blinking of the LEDs is not supported in automatic mode. [Table 1](#) identifies the mapping of color to port state in automatic mode.

**Table 1. Automatic Port State to Port Indicator Color Mapping**

Downstream Facing Hub Port State	
Color Definition	Port State
Off or Amber, if due to an overcurrent condition	Powered Off
Off	Disconnected, Disabled, Not Configured, Resetting, Testing
Green	Enabled, Transmit, or TransmitR
Off	Suspended, Resuming, SendEOR, Restart_E/S

The LED control lines can also be modulated with a square wave for power conservation. The polarity of these pins is programmable, see [Configuration Options on page 14](#).

In manual mode, the indicators are under the control of the host, which can turn on the LEDs, or leave them off. This is done by a USB Hub class request. Blinking of the LEDs is supported in manual mode. The port indicators enable the user to intervene in any error detection. For example, when babble is detected while plugging in a defective device, or when an overcurrent condition occurs, the port indicators corresponding to the downstream port blink green or only light the amber LED, respectively.

[Table 2](#) displays the color definition of the indicators when CY7C65620/CY7C65630 is in manual mode.<sup>[1]</sup>

**Table 2. Port Indicator Color Definitions in Manual Mode**

Color Definition	Port State
Off	Not operational
Amber	Error condition
Green	Fully operational
Blinking Off / Green	Software attention
Blinking Off / Amber	Hardware attention
Blinking Green / Amber	Reserved

**Note**

1. Information presented in [Table 1](#) and [Table 2](#) is from USB 2.0 specification Tables 11-6 and 11-7, respectively.



## Pin Configuration

Figure 1. 56-pin Quad Flat Pack No Leads (8 mm × 8 mm) [2]

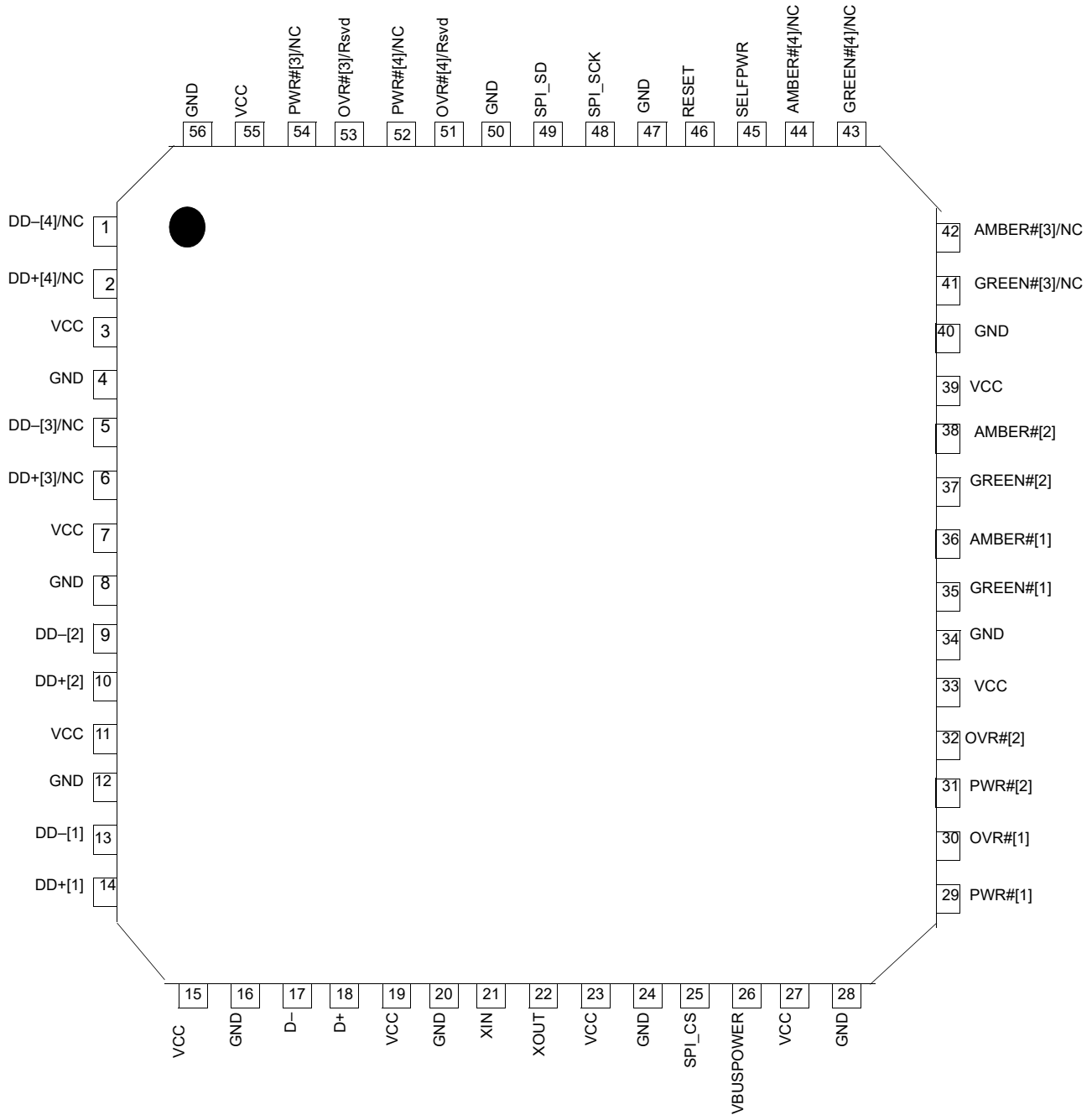

**Note**

2. NC and Rsvd are for CY7C65620 only.

## Pin Definitions

**Table 3. Pin Assignments<sup>[3]</sup>**

Pin	CY7C65630 Name	CY7C65620 Name	Type	Default	Description
3	V <sub>CC</sub>	V <sub>CC</sub>	Power	N/A	V <sub>CC</sub> . This signal provides power to the chip.
7	V <sub>CC</sub>	V <sub>CC</sub>	Power	N/A	V <sub>CC</sub> . This signal provides power to the chip.
11	V <sub>CC</sub>	V <sub>CC</sub>	Power	N/A	V <sub>CC</sub> . This signal provides power to the chip.
15	V <sub>CC</sub>	V <sub>CC</sub>	Power	N/A	V <sub>CC</sub> . This signal provides power to the chip.
19	V <sub>CC</sub>	V <sub>CC</sub>	Power	N/A	V <sub>CC</sub> . This signal provides power to the chip.
23	V <sub>CC</sub>	V <sub>CC</sub>	Power	N/A	V <sub>CC</sub> . This signal provides power to the chip.
27	V <sub>CC</sub>	V <sub>CC</sub>	Power	N/A	V <sub>CC</sub> . This signal provides power to the chip.
33	V <sub>CC</sub>	V <sub>CC</sub>	Power	N/A	V <sub>CC</sub> . This signal provides power to the chip.
39	V <sub>CC</sub>	V <sub>CC</sub>	Power	N/A	V <sub>CC</sub> . This signal provides power to the chip.
55	V <sub>CC</sub>	V <sub>CC</sub>	Power	N/A	V <sub>CC</sub> . This signal provides power to the chip.
4	GND	GND	Power	N/A	GND. Connect to ground with as short a path as possible.
8	GND	GND	Power	N/A	GND. Connect to ground with as short a path as possible.
12	GND	GND	Power	N/A	GND. Connect to ground with as short a path as possible.
16	GND	GND	Power	N/A	GND. Connect to ground with as short a path as possible.
20	GND	GND	Power	N/A	GND. Connect to ground with as short a path as possible.
24	GND	GND	Power	N/A	GND. Connect to ground with as short a path as possible.
28	GND	GND	Power	N/A	GND. Connect to ground with as short a path as possible.
34	GND	GND	Power	N/A	GND. Connect to ground with as short a path as possible.
40	GND	GND	Power	N/A	GND. Connect to ground with as short a path as possible.
47	GND	GND	Power	N/A	GND. Connect to ground with as short a path as possible.
50	GND	GND	Power	N/A	GND. Connect to ground with as short a path as possible.
56	GND	GND	Power	N/A	GND. Connect to ground with as short a path as possible.
21	XIN	XIN	Input	N/A	24 MHz crystal IN or external clock input.
22	XOUT	XOUT	Output	N/A	24 MHz crystal OUT. (NC if external clock is used)
46	RESET#	RESET#	Input	N/A	Active LOW reset. This pin resets the entire chip. It is normally tied to V <sub>CC</sub> through a 100 K resistor, and to GND through a 0.1 μF capacitor. No other special power-up procedure is required.
45	SELPWR	SELPWR	Input	N/A	Self power. Indicator for bus or self powered. 0 is bus powered, 1 is self powered.
26	VBUSPOWER	VBUSPOWER	Input	N/A	VBUS. Connect to the VBUS pin of the upstream connector. This signal indicates to the hub that it is in a connected state, and may enable the D+ pull-up resistor to indicate a connection. (The hub does so after the external EEPROM is read).
<b>SPI Interface</b>					
25	SPI_CS	SPI_CS	Output	O	SPI chip select. Connect to CS pin of the EEPROM.
48	SPI_SCK	SPI_SCK	Output	O	SPI clock. Connect to EEPROM SCK pin.
49	SPI_SD	SPI_SD	I/O/Z	Z	SPI dataline connect to GND with 15 kΩ resistor and to the Data I/O pin of the EEPROM.
<b>Upstream Port</b>					
17	D-	D-	I/O/Z	Z	Upstream D- Signal.
18	D+	D+	I/O/Z	Z	Upstream D+ Signal.

**Note**

3. Unused port DD+/DD- lines can be left floating. Leave the port power, amber, and green LED pins unconnected, and deassert the overcurrent pin. Do not leave the overcurrent pin floating; it is an input. SPI data line should be connected to GND with 15 kΩ resistor (Even if no EEPROM is used).

**Table 3. Pin Assignments<sup>[3]</sup> (continued)**

Pin	CY7C65630 Name	CY7C65620 Name	Type	Default	Description
<b>Downstream Port 1</b>					
13	DD-[1]	DD-[1]	I/O/Z	Z	Downstream D- Signal.
14	DD+[1]	DD+[1]	I/O/Z	Z	Downstream D+ Signal.
36	AMBER#[1]	AMBER#[1]	Output	1	LED. Driver output for Amber LED. Port indicator support. Default is active LOW. Polarity is controlled through EEPROM.
35	GREEN#[1]	GREEN#[1]	Output	1	LED. Driver output for Green LED. Port indicator support. Default is active LOW. Polarity is controlled through EEPROM.
30	OVR#[1]	OVR#[1]	Input	1	Overcurrent condition detection input. Default is active LOW. Polarity is controlled through EEPROM.
29	PWR#[1]	PWR#[1]	O/Z	Z	Power switch driver output. Default is active LOW. Polarity is controlled through EEPROM.
<b>Downstream Port 2</b>					
9	DD-[2]	DD-[2]	I/O/Z	Z	Downstream D- Signal.
10	DD+[2]	DD+[2]	I/O/Z	Z	Downstream D+ Signal.
38	AMBER#[2]	AMBER#[2]	Output	1	LED. Driver output for amber LED. Port indicator support. Default is active LOW. Polarity is controlled through EEPROM.
37	GREEN#[2]	GREEN#[2]	Output	1	LED. Driver output for green LED. Port indicator support. Default is active LOW. Polarity is controlled through EEPROM.
32	OVR#[2]	OVR#[2]	Input	1	Overcurrent condition detection input. Default is active LOW. Polarity is controlled through EEPROM.
31	PWR#[2]	PWR#[2]	O/Z	Z	Power switch driver output. Default is active LOW. Polarity is controlled through EEPROM.
<b>Downstream Port 3</b>					
5	DD-[3]	NC	I/O/Z	Z	Downstream D- Signal.
6	DD+[3]	NC	I/O/Z	Z	Downstream D+ Signal.
42	AMBER#[3]	NC	Output	1	LED. Driver output for amber LED. Port indicator support. Default is active LOW. Polarity is controlled through EEPROM.
41	GREEN#[3]	NC	Output	1	LED. Driver output for Green LED. Port indicator support. Default is active LOW. Polarity is controlled through EEPROM.
53	OVR#[3]	Reserved	Input	1	Overcurrent condition detection input. Default is active LOW. Polarity is controlled through EEPROM. Reserved. Pull to deasserted state with external resistor (CY7C65620 only)
54	PWR#[3]	NC	O/Z	Z	Power switch driver output. Default is active LOW. Polarity is controlled through EEPROM.
<b>Downstream Port 4</b>					
1	DD-[4]	NC	I/O/Z	Z	Downstream D- Signal.
2	DD+[4]	NC	I/O/Z	Z	Downstream D+ Signal.
44	AMBER#[4]	NC	Output	1	LED. Driver output for amber LED. Port indicator support. Default is active LOW. Polarity is controlled through EEPROM.
43	GREEN#[4]	NC	Output	1	LED. Driver output for green LED. Port indicator support. Default is active LOW. Polarity is controlled through EEPROM.
51	OVR#[4]	Reserved	Input	1	Overcurrent condition detection input. Default is active LOW. Polarity is controlled through EEPROM. Reserved. Pull to deasserted state with external resistor (CY7C65620 only)
52	PWR#[4]	NC	O/Z	Z	Power switch driver output. Default is active LOW. Polarity is controlled through EEPROM.

## Default Descriptors

This section presents the different descriptors that are available. The following tables list the functionality of each descriptor.

### Device Descriptor

The standard device descriptor for CY7C65620/CY7C65630 is based on the information found in the SPI EEPROM. The information in the EEPROM overrides the default descriptor values. If no EEPROM is used, the CY7C65620/CY7C65630 enumerates with the default descriptor values as shown in the following table. If a blank EEPROM is connected, the hub enumerates as vendor defined class instead of a hub class. This is for the purpose of programming the EEPROM with the Cypress driver.

Byte	Full Speed	High Speed	Field Name	Description
0	0x12	0x12	bLength	18 bytes
1	0x01	0x01	bDescriptorType	DEVICE_DESCRIPTOR
2,3	0x0110	0x0200	bcdUSB	USB specification 2.0 (1.1 if forced FS)
4	0x09	0x09	bDeviceClass	HUB
5	0x00	0x00	bDeviceSubClass	None
6	0x00	0x01	bDeviceProtocol	None
7	0x40	0x40	bMaxPacketSize0	64 bytes
8,9	0x04B4	0x04B4	wIdVendor	VID (overridden by what is defined in EEPROM)
10,11	0x6560	0x6560	wIdProduct	PID (overridden by what is defined in EEPROM)
12, 13	0x0915	0x0915	wbcdDevice	DID (overridden by what is defined in EEPROM)
14	0x00	0x00	iManufacturer	Overridden by EEPROM
15	0x00	0x00	iProduct	Overridden by EEPROM
16	0x00	0x00	iSerialNumber	Overridden by EEPROM
17	0x01	0x01	bNumConfigurations	One configuration supported

### Configuration Descriptor

Byte	Full Speed	High Speed	Field Name	Description
0	0x09	0x09	bLength	9 bytes
1	0x02 <sup>[4]</sup> /0x07 <sup>[5]</sup>	0x02 <sup>[4]</sup> /0x07 <sup>[5]</sup>	bDescriptorType	CONFIG_DESCRIPTOR
2	0x0019	0x0019	wTotalLength	Length of all other descriptors
4	0x01	0x01	bNumInterfaces	1
5	0x01	0x01	bConfigurationValue	The configuration to use
6	0x00	0x00	iConfiguration	Index of string descriptor describing this configuration
7	0xA0 0xE0	0xA0 0xE0	bmAttributes	Value depends on pin 45 - SELFPWR signal SELPWR = 0 yields 0xA0 and =1 yields 0xE0
8	0x28	0x57 <sup>[4]</sup>	bMaxPower	Maximum power consumption of hub from the USB bus

#### Notes

4. Configured speed descriptor.
5. Other speed descriptor.

### Interface Descriptor

Byte	Full Speed	High Speed	Field Name	Description
0	0x09	0x09	bLength	9 bytes
1	0x04	0x04	bDescriptorType	INTERFACE_DESCRIPTOR
2	0x00	0x00	bInterfaceNumber	Number of this interface
3	0x00	0x00	bAlternateSetting	Value used to select this alternate setting for the interface
4	0x01	0x01	bNumEndpoints	Number of endpoints used by this interface (not including endpoint 0)
5	0x09	0x09	bInterfaceClass	Hub class code
6	0x00	0x00	bInterfaceSubClass	Subclass code (assigned by the USB-IF)
7	0x00	0x00	bInterfaceProtocol	Protocol code (assigned by the USB-IF)
8	0x00	0x00	iInterface	Index of the string descriptor describing this interface

### Endpoint Descriptor

Byte	Full-Speed	High-Speed	Field Name	Description
0	0x07	0x07	bLength	7 bytes
1	0x05	0x05	bDescriptorType	ENDPOINT_DESCRIPTOR
2	0x81	0x81	bEndpointAddress	IN Endpoint #1
3	0x03	0x03	bmAttributes	Interrupt
4, 5	0x0001	0x0001	wMaxPacketSize	Maximum packet size
6	0xFF	0x0C	bInterval	Polling rate

### Device Qualifier Descriptor

Byte	Full-Speed	High-Speed	Field Name	Description
0	0x0A	0x0A	bLength	10 bytes
1	0x06	0x06	bDescriptorType	DEVICE_QUALIFIER
2, 3	0x0200	0x0200	bcdUSB	USB Specification Release Number in Binary-Coded Decimal
4	0x09	0x09	bDeviceClass	Class code (assigned by the USB-IF)
5	0x00	0x00	bDeviceSubClass	Subclass code (assigned by the USB-IF)
6	0x01	0x00	bDeviceProtocol	Protocol code (assigned by the USB-IF)
7	0x40	0x40	bMaxPacketSize0	Maximum packet size for other speed
8	0x01	0x01	bNumConfigurations	Number of other-speed configurations
9	0x00	0x00	bReserved	Reserved for future use, must be zero

**Hub Descriptor**

Byte	All Speed	Field Name	Description
0	0x09	bLength	9 bytes
1	0x29	bDescriptorType	HUB descriptor
2	0x04 <sup>[6]</sup> 0x02	bNbrPorts	Number of ports supported, CY7C65630 Number of ports supported, CY7C65620
3,4	0x0089 <sup>[6]</sup>	wHubCharacteristics	b1, b0: Logical power switching mode 00: Ganged power switching (all ports' power at once). 01: Individual port power switching (Default in CY7C65620/CY7C65630). b2: Identifies a compound device 0: Hub is not part of a compound device (Default in CY7C65620/CY7C65630). 1: Hub is part of a compound device. b4, b3: Overcurrent protection mode 00: Global overcurrent protection. The hub reports overcurrent as a summation of all ports' current draw, without a breakdown of individual port overcurrent status. 01: Individual port overcurrent protection. The hub reports overcurrent on a per-port basis. Each port has an overcurrent status (Default in CY7C65620/CY7C65630). 1X: No overcurrent protection. This option is allowed only for bus powered hubs that do not implement overcurrent protection. b6, b5: TT think time 00: TT requires at most eight FS bit times of inter transaction gap on a full/low-speed downstream bus (Default in CY7C65620/CY7C65630). b7: Port indicators supported, 0: Port indicators are not supported on its downstream facing ports and the SetPortIndicator request has no effect. 1: Port indicators are supported on its downstream facing ports and the SetPortIndicator request controls the indicators. See <a href="#">"Functional Overview"</a> on page 5 and <a href="#">"Supported USB Requests"</a> on page 18. (Default in CY7C65620/CY7C65630). b15, b8: Reserved
5	0x32 <sup>[6]</sup>	bPwrOn2PwrGood	Time from when the port is powered to when the power is good on that port.
6	0x28 <sup>[6]</sup> 0xAE <sup>[6]</sup>	bHubContrCurrent	Maximum current requirement for the hub controller at full-speed. Maximum current requirement for the hub controller at high-speed.
7	0x00 <sup>[6]</sup>	bDeviceRemovable	Indicates if the logical port has a removable device attached (0 = removable, 1 = non removable).
8	0xFF <sup>[6]</sup>	bPortPwrCtrlMask	Required for compatibility with software written for 1.0 compliant devices.

**Note**

6. This value is configured through the external EEPROM.

## Configuration Options

Systems using CY7C65620/CY7C65630 have the option of using a fuse ROM, which is preset at the factory to configure the hub. Otherwise, it must have an external EEPROM for the device to have a unique VID, PID, and DID. The CY7C65620/CY7C65630 can communicate with SPI EEPROM that are either double byte addressed or single byte with the ninth bit within the instruction byte, such as the 24LC040 parts use. The 25LC080 EEPROM uses the double byte address format. Therefore, the CY7C65620/CY7C65630 can communicate with these parts. The '010s and '020s use the same command format that is used to interface with the '040 and hence these can also be used to interface with the CY7C65620/CY7C65630.

If the attached EEPROM is blank (0xFF) the hub enumerates as a vendor class device. In this configuration, the hub connects to the Cypress driver to allow programming of the EEPROM. When the EEPROM is programmed, a power cycle configures the chip as a hub class device.

### 0xD0 Load

With this EEPROM format, only a unique VID, PID, and DID must be present in the external SPI EEPROM. The contents of the EEPROM must contain this information in the following format:

Byte	Value
0	0xD0
1	VID (LSB)
2	VID (MSB)
3	PID (LSB)
4	PID (MSB)
5	reserved
6	DID (MSB)

### 0xD2 Load

Byte	Value (MSB ≥ LSB)
0	0xD2
1	VID (LSB)
2	VID (MSB)
3	PID (LSB)
4	PID (MSB)
5	reserved
6	DID (MSB)
7	EnabledOverCurrentTimer[3:0], DisableOvercurrentTimer[3:0]
8	ActivePorts[3:0], RemovablePorts[3:0]
9	MaxPower
10	HubControllerPower
11	PowerOnTimer
12	IllegalHubDescriptor, CompoundDevice, FullspeedOnly, NoPortIndicators, Reserved, GangPowered, Reserved, Reserved

### Byte 0: 0xD2

Needs to be programmed with 0xD2

### Byte 1: VID (LSB)

Least significant byte of vendor ID

### Byte 2: VID (MSB)

Most significant byte of vendor ID

### Byte 3: PID (LSB)

Least significant byte of product ID

### Byte 4: PID (MSB)]

Most significant byte of product ID

### Byte 5: Reserved

Reserved

### Byte 6: DID (MSB)]

Most significant byte of device ID

### Byte 7: EnabledOvercurrentTimer[3:0], DisabledOvercurrentTimer[3:0]

Count time in ms for filtering overcurrent detection. Bits 7–4 are for an enabled port, and bits 3–0 are for a disabled port. Both range from 0 ms to 15 ms. See [Port Indicators on page 6](#). Default: 8 ms = 0x88.

### Byte 8: ActivePorts[3:0], RemovablePorts[3:0]

Bits 7–4 are the ActivePorts[3:0] bits that indicates if the corresponding port is usable. For example, a two-port hub that uses ports 1 and 4 would set this field to 0x09. The total number of ports reported in the Hub Descriptor: bNbrPorts field is calculated from this. Bits 3–0 are the RemovablePorts[3:0] bits that indicates whether the corresponding logical port is removable (set to high). Logical port numbers are from 1 to n where n is the total number of active ports. If port 2 is disabled then physical ports 1, 3, and 4 map to logical ports 1, 2, and 3. These bit values are reported appropriately in the HubDescriptor:DeviceRemovable field. Default: 0xFF.

### Byte 9: MaximumPower

This value is reported in the ConfigurationDescriptor:bMaxPower field and is the current in 2 mA increments that is required from the upstream hub. Default: 0x28 = 80 mA for full-speed and 0x57 = 174 mA for high-speed.

### Byte 10: HubControllerPower

This value is reported in the HubDescriptor:bHubContrCurrent field and is the current in milliamperes required by the hub controller. Default: 0x50 = 80 mA for full-speed and 0xAE = 174 mA for high-speed.

### Byte 11: PowerOnTimer

This value is reported in the HubDescriptor:bPwrOn2PwrGood field and is the time in 2 ms intervals from the SetPortPower command until the power on the corresponding downstream port is good. Default: 0x32 = 100 ms.



**Byte 12: IllegalHubDescriptor, CompoundDevice, Full Speed Only, NoPortIndicators, Reserved, GangPowered, Reserved, Reserved**

Bit 7: IllegalHubDescriptor. For GetHubDescriptor request, some USB hosts use a DescriptorType of 0x00 instead of HUB\_DESCRIPTOR, 0x29. According to the USB 2.0 standard, a hub must treat this as a Request Error, and STALL the transaction accordingly (USB 2.0, 11.24.2.5). For systems that do not accept this, the IllegalHubDescriptor configuration bit can be set to allow CY7C65620/CY7C65630 to accept a DescriptorType of 0x00 for this command. Default is 1.

Bit 6: CompoundDevice. Indicates whether the hub is part of a compound device. This is reported in the HubDescriptor, wHub-Characteristics: b2. Default set to '0'.

Bit 5: Fullspeed. Only configures the hub to be a full-speed only device. Default is set to '0'.

Bit 4: NoPortIndicators. Turns off the port indicators and does not report them as present in the HubDescriptor, wHubCharacteristics b7 field. Default is set to '0'.

Bit 3: Reserved. Set this bit to '0'.

Bit 2: GangPowered. Indicates whether the port power switching is ganged (set to 1) or per-port (set to '0'). This is reported in the HubDescriptor, wHubCharacteristics field, b4, b3, b1, and b0. Default is set to '0'.

Bit 1: Reserved. Default is set to '0'.

Bit 0: Reserved. Default is set to '0'.

**0xD4 Load**

Byte	Value (MSB ≥ LSB)	Factory Fusable
0	0xD4	
1	VID (LSB)	X
2	VID (MSB)	X
3	PID (LSB)	X
4	PID (MSB)	X
5	reserved	
6	DID (MSB)	X
7	EnabledOverCurrentTimer[3:0], DisableOvercurrentTimer[3:0]	
8	MaxPower (full-speed)	X
9	MaxPower (high-speed)	X
10	Reserved	
11	Reserved	
12	HubControllerPower full-speed bus powered	X
13	HubControllerPower high-speed bus powered	X
14	HubControllerPower full-speed self powered	

**0xD4 Load (continued)**

Byte	Value (MSB ≥ LSB)	Factory Fusable
15	HubControllerPower high-speed self powered	
16	PowerOnTimer	
17	IllegalHubDescriptor, CompoundDevice, FullspeedOnly, NoPortIndicators, Reserved, GangPowered, Reserved, Reserved	X
18	AmberPolarity, GreenPolarity, ModulateIndicators, PowerControlPolarity, OverCurrentPolarity, OverCurrentMode1, OverCurrentMode2	X
19	Write protect	
20	NumLangs	
21	SupportedStrings	
22	ActivePorts[3:0]	
23	RemovablePorts[3:0]	X
24	LangID	
a=24+2N	iManufacturer	
b=a+2N	iProduct	
c=b+2N	iSerialNumber	
d=c+2N	iConfiguration(FS)	
e=d+2N	iConfiguration(HS)	
f=e+2N	iInterface(0)	
g=f+2N	reserved	
h=g+2N	Strings	

N:NumLangs

**Byte 0: 0xD4**

Needs to be programmed with 0xD4

**Byte 1: VID (LSB)**

Least significant byte of vendor ID

**Byte 2: VID (MSB)**

Most significant byte of vendor ID

**Byte 3: PID (LSB)**

Least significant byte of product ID

**Byte 4: PID (MSB)**

Most significant byte of product ID

**Byte 5: Reserved**

Reserved

**Byte 6: DID (MSB)**

Most significant byte of device ID



**Byte 7: EnabledOvercurrentTimer[3:0], DisabledOvercurrentTimer[3:0]**

Count time in ms for filtering overcurrent detection. Bits 7–4 are for an enabled port, and bits 3–0 are for a disabled port. Both range from 0 ms to 15 ms. See [Port Indicators on page 6](#). Default: 8 ms = 0x88.

**Byte 8: MaximumPower (Full-speed)**

This value is reported in the ConfigurationDescriptor:bMaxPower field and is the current in 2 mA increments that is required from the upstream hub when connected at full-speed. Default: 0x28 = 80 mA for full-speed.

**Byte 9: MaximumPower (High-speed)**

This value is reported in the ConfigurationDescriptor:bMaxPower field and is the current in 2 mA increments that is required from the upstream hub when connected at high-speed. Default: 0x57 = 174 mA for high-speed.

**Byte 10: Reserved**

Write zeros to this location.

**Byte 11: Reserved**

Write zeros to this location.

**Byte 12: HubControllerPower (Full-speed, bus-powered)**

This value is reported in the HubDescriptor:bHubContrCurrent field and is the current in milliamperes required by the hub controller when connected on the upstream hub as a full-speed. Default: 0x50 = 80 mA for full-speed.

**Byte 13: HubControllerPower (High-speed, bus-powered)**

This value is reported in the HubDescriptor:bHubContrCurrent field and is the current in milliamperes required by the hub controller when connected on the upstream hub as a high-speed. Default: 0xAE = 174 mA for high-speed.

**Byte 14: HubControllerPower (Full-speed, self-powered)**

This value is reported in the HubDescriptor:bHubContrCurrent field and is the current in milliamperes required by the hub controller when connected on the upstream hub as a full-speed. Default: 0x50 = 80 mA for full-speed.

**Byte 15: HubControllerPower (High-speed, self-powered)**

This value is reported in the HubDescriptor:bHubContrCurrent field and is the current in milliamperes required by the hub controller when connected on the upstream hub as a high-speed. Default: 0x64 = 100 mA for high-speed.

**Byte 16: PowerOnTimer**

This value is reported in the HubDescriptor:bPwrOn2PwrGood field and is the time in 2 ms increments from the SetPortPower command until the power on the corresponding downstream port is good. Default: 0x32 = 100 ms.

**Byte 17: IllegalHubDescriptor, CompoundDevice, Full-Speed Only, NoPortIndicators, Reserved, GangPowered, Reserved, Reserved**

Bit 7: IllegalHubDescriptor. For GetHubDescriptor request, some USB hosts use a DescriptorType of 0x00 instead of HUB\_DESCRIPTOR, 0x29. According to the USB 2.0 standard, a hub must treat this as a request error, and STALL the transaction accordingly (USB 2.0, 11.24.2.5). For systems that do not accept this, the IllegalHubDescriptor configuration bit may be set to allow CY7C65620/CY7C65630 to accept a DescriptorType of 0x00 for this command. Default set to 1.

Bit 6: CompoundDevice. Indicates whether the hub is part of a compound device. This is reported in the HubDescriptor, wHub-Characteristics: b2. Default is set to '0'.

Bit 5: Fullspeed. Only configures the hub to be a full speed only device. Default is set to '0'.

Bit 4: NoPortIndicators. Turns off the port indicators and does not report them as present in the HubDescriptor, wHubCharacteristics b7 field. Default is set to '0'.

Bit 3: Reserved. Set this bit to '0'.

Bit 2: GangPowered. Indicates whether the port power switching is ganged (set to 1) or per-port (set to '0'). This is reported in the HubDescriptor, wHubCharacteristics field, b4, b3, b1, and b0. Default is set to '0'.

Bit 1: Reserved. Default is set to '0'.

Bit 0: Reserved. Default is set to '0'.

**Byte 18: AmberPolarity, GreenPolarity, SelfPowerable, ModulateIndicators, PowerControlPolarity, OverCurrentPolarity, OverCurrentMode1, OverCurrentMode2**

Bit 7: AmberPolarity. Indicates the polarity of the amber indicator control. (1 = high, 0 = low)

Bit 6: GreenPolarity. Indicates the polarity of the green indicator control. (1 = high, 0 = low)

Bit 5: SelfPowerable. Indicates whether the hub is capable of operating in self powered mode. If '0', the hub is capable of bus powered operation only.

Bit 4: ModulateIndicators. If this bit is set, the indicator outputs are modulated by a square wave of 120 Hz, for power savings. If '0', the outputs are static.

Bit 3: PowerControlPolarity. If set, the power control outputs are active HIGH. If not set, the power control outputs are active LOW.

Bit 2: OverCurrentPolarity. If set, the overcurrent inputs are active HIGH. If not set, the overcurrent inputs are active LOW.

Bit 1: OverCurrentMode1. Reported as bit 4 of the wHubCharacteristics field of the hub descriptor. If set to '1', this bit disables overcurrent detection.

Bit 0: OverCurrentMode2. Reported as bit 3 of the wHubCharacteristics field of the hub descriptor. If Bit 1 of this byte is set to '0', overcurrent detection is enabled. If this bit (Bit 0) is set to '1', the hub reports overcurrent on a per-port basis. If set to '0', the hub reports overcurrent as the summation of all ports' current draw.

**Byte 19: Write Protect**

Writing the value 0x42 to this field enables Write Protect and any future writes to the EEPROM fail. Default is set to '0'.

**Byte 20: NumLangs**

Number of supported string languages. CY7C65620/CY7C65630 supports a maximum of 31 languages; if this field is set to '0' or a number larger than 31, all string support is disabled.

**Byte 21: SupportedStrings**

This field contains a bitmap of strings supported by the hub. A set bit indicates that the standard string is supported. A bit not set indicates that the string is not supported. The hub controller returns a non zero index for each string that is supported, and returns 0x00 for each string not supported, as indicated by this field. The bits in this field correspond to the following standard strings.

**Table 4. Byte 21 Supported Strings**

Bit	Name	Description
7	Reserved	–
6	Reserved	–
5	Interface (0)	The Interface string index reported in the first interface descriptor (alternate setting 0)
4	iConfiguration	(high speed) The iConfiguration string index reported in the configuration descriptor, when operating at high speed
3	iConfiguration	(full speed) The iConfiguration string index reported in the configuration descriptor, when operating at full speed
2	iSerial Number	The iSerialNumber string index reported in the device descriptor
1	iProduct	The iProduct string index reported in the device descriptor
0	iManufacturer	The iManufacturer string index reported in the device descriptor

**Byte 22: ActivePorts[3:0]**

Bits 3–0 are the ActivePorts[3:0] bits that indicates if the corresponding port is usable. For example, a two-port hub that uses ports 1 and 4 sets this field to 0x09. The total number of ports reported in the Hub Descriptor: bNbrPorts field is calculated from this. Default 0x0F.

**Byte 23: RemovablePorts[3:0]**

Bits 3–0 are the RemovablePorts[3:0] bits that indicates whether the corresponding logical port is removable (set to high). Logical port numbers are from 1 to n where n is the total number of active ports. If port 2 is disabled then physical ports 1, 3, and 4 map to logical ports 1, 2, and 3. These bit values are recorded in the HubDescriptor:DeviceRemovable field. Default 0x0F.

**Byte 24: LangID**

Array of LangID codes supported by the hub. Each LangID consists of two bytes, stored LSB first. The array has NumLangs entries (2 × NumLangs bytes).

**Byte a: iManufacturer**

Array of addresses for the iManufacturer strings. Each address is two bytes long, stored LSB first. The array has NumLangs entries (2 × NumLangs bytes). The starting EEPROM address is based upon the number entered for NumLangs. The address  $a = 24 + 2 \times \text{NumLangs}$ .

**Byte b: iProduct**

Array of addresses for the iProduct strings. Each address is two bytes long, stored LSB first. The array has NumLangs entries (2 × NumLangs bytes). The address  $b = a + 2 \times \text{NumLangs}$ .

**Byte c: iSerialNumber**

Array of addresses for the iSerialNumber strings. Each address is two bytes long, stored LSB first. The array has NumLangs entries (2 × NumLangs bytes). The address  $c = b + 2 \times \text{NumLangs}$ .

**Byte d: iConfiguration(Full Speed)**

Array of addresses for the iConfiguration (full speed) strings. Each address is two bytes long, stored LSB first. The array has NumLangs entries (2 × NumLangs bytes). The address  $d = c + 2 \times \text{NumLangs}$ .

**Byte e: iConfiguration(High Speed)**

Array of addresses for the iConfiguration (high speed) strings. Each address is two bytes long, stored LSB first. The array has NumLangs entries (2 × NumLangs bytes). The address  $e = d + 2 \times \text{NumLangs}$ .

**Byte f: iInterface(0)**

Array of addresses for the iInterface(0) strings. Each address is two bytes long, stored LSB first. The array has NumLangs entries (2 × NumLangs bytes). The address  $f = e + 2 \times \text{NumLangs}$ .

**Byte g: iInterface(1)**

Reserved

**Byte h: Strings**

Strings addressed by the string pointers. Strings must comply with the USB specification. The first byte must be the length of the string in bytes, the second must be 0x03, and the string must be in Unicode.

## Supported USB Requests

### Device Class Commands

Table 5. Device Class Requests

Request	bmRequestType	bRequest	wValue	wIndex	wLength	Data
GetDeviceStatus	10000000B	0x00	0x0000	0x0000	0x0002	2 Byte device status
GetInterfaceStatus	10000001B	0x00	0x0000	0x0000	0x0002	2 Byte interface status
GetEndpointStatus	10000010B	0x00	0x0000	0x0000	0x0002	2 Byte endpoint status
GetDeviceDescriptor	10000000B	0x06	0x0001	Zero or language ID	Descriptor length	Descriptor
GetConfigDescriptor	10000000B	0x06	0x0002	Zero or language ID	Descriptor length	Descriptor
GetDeviceQualifierDescriptor	10000000B	0x06	0x0006	Zero or language ID	Descriptor length	Descriptor
GetOtherSpeedConfiguration Descriptor	10000000B	0x06	0x0007	Zero or language ID	Descriptor length	Descriptor
GetConfiguration <sup>[7]</sup>	10000000B	0x08	0x0000	0x0000	0x0001	Configuration value
SetConfiguration <sup>[7]</sup>	00000000B	0x09	Configuration value	0x0000	0x0000	None
GetInterface	10000001B	0xA	0x0000	0x0000	0x0001	Interface number

SetInterface	00000001B	0x0B	Alternate setting	Interface number	0x0000	None
SetAddress	00000000B	0x05	Device address	0x0000	0x0000	None
SetDeviceRemoteWakeup	00000000B	0x03	0x01	0x0000	0x0000	None
SetDeviceTest_J	00000000B	0x03	0x02	0x0100	0x0000	None
SetDeviceTest_K	00000000B	0x03	0x02	0x0200	0x0000	None
SetDeviceTest_SE0_NAK	00000000B	0x03	0x02	0x0300	0x0000	None
SetDeviceTest_Packet	00000000B	0x03	0x02	0x0400	0x0000	None
SetEndpointHalt	00000000B	0x03	0x00	0x0000	0x0000	None
ClearDeviceRemoteWakeup	00000000B	0x01	0x01	0x0000	0x0000	None
ClearEndpointHalt	00000000B	0x01	0x00	0x0000	0x0000	None

**Note**

7. Only one configuration is supported in CY7C65620/CY7C65630.

**Hub Class Commands**

**Table 6. Hub Class Requests**

Request	bmRequestType	bRequest	wValue	wIndex	wLength	Data
GetHubStatus	10100000B	0x00	0x0000	0x0000	0x0004	Hub status (See Table 11-19 of USB 2.0 Specifications) Change status (See Table 11-20 of USB 2.0 specifications)
GetPortStatus	10100011B	0x00	0x0000	Byte 0: 0x00 Byte 1: Port	0x0004	Port status (See Table 11-21 of USB 2.0 Specifications) Change status (See Table 11-20 of USB 2.0 specifications)
ClearHubFeature	00100000B	0x01	Feature selectors <sup>[8]</sup> 0 or 1	0x0000	0x0000	None
ClearPortFeature	00100011B	0x01	Feature selectors <sup>[8]</sup> 1, 2, 8, 16, 17, 18, 19, or 20	Byte 0: 0x00 Byte 1: Port	0x0000	None
ClearPortFeature	00100011B	0x01	Feature selectors <sup>[8]</sup> 22 (PORT_INDICATOR)	Byte 0: - Byte 1: Port	0x0000	None
SetHubFeature	00100000B	0x03	Feature selector <sup>[8]</sup> 0 or 1	0x0000	0x0000	None
SetPortFeature	00100011B	0x03	Feature selectors <sup>[8]</sup> 2, 4 or 8	Port	0x0000	None
SetPortFeature	00100011B	0x03	Feature selector <sup>[8]</sup> 21 (PORT_TEST)	Byte 0: selectors <sup>[8]</sup> 1,2, 3, 4 or 5 Byte 1: Port	0x0000	None

SetPortFeature	00100011B	0x03	Feature selector <sup>[8]</sup> 22 (PORT_INDICATOR)	Byte 0: selectors <sup>[9]</sup> 0, 1, 2, or 3 Byte 1: Port	0x0000	None
GetHubDe- scriptor	10100000B	0x06	Descriptor type and descriptor index	Zero/ Language ID	Hub descriptor length	Descriptor
ClearTTBuffer	00100011B	0x08	Dev_Addr, EP_Num	TT_Port	0x0000	None
ResetTT	00100000B	0x09	0x0000	Byte 0: 0x00 Byte 1: Port	0x0000	None
GetTTState	10100011B	0x0A	TT_Flags	Byte 0: 0x00 Byte 1: Port	TT state length	TT state
StopTT	00100011B	0x0B	0x0000	Byte 0: 0x00 Byte 1: Port	0x0000	None

**Notes**

- 8. Selector values for different features are presented in [Table 7 on page 20](#).
- 9. Selector values for different features are presented in [Table 9 on page 20](#).

**Table 6. Hub Class Requests** (continued)

Request	bmRequestType	bRequest	wValue	wIndex	wLength	Data
<b>Vendor Commands</b>						
Read EEPROM	11000000B	0x02	0x00	0x00	Length	Data
This request results in reading length bytes of data from the external memory device and returned to the host. Data is read beginning with address 0. This request fails if there is no external memory device present. This request is only valid if the hub is in the configured state; the request fails otherwise.						
Write EEPROM	01000000B	0x01	0x00	0x00	Length	Data
This request results in writing length bytes of data to the external memory device. Data is written beginning with address 0. This request fails if there is no external memory device present. This request is only valid if the hub is in the configured state or if the external memory device write protect byte is set; the request fails otherwise.						

**Table 7. Hub Class Feature Selector**

Feature Selector	Recipient	Value
C_HUB_LOCAL_POWER	Hub	0
C_HUB_OVER_CURRENT	Hub	1
PORT_CONNECTION	Port	0
PORT_ENABLE	Port	1
PORT_SUSPEND	Port	2
PORT_RESET	Port	4
PORT_POWER	Port	8
PORT_LOW_SPEED	Port	9
C_PORT_CONNECTION	Port	16
C_PORT_ENABLE	Port	17
C_PORT_SUSPEND	Port	18
C_PORT_OVER_CURRENT	Port	19
C_PORT_RESET	Port	20
PORT_TEST	Port	21
PORT_INDICATOR	Port	22

**Table 8. Test Mode Selector for Feature Selector PORT\_TEST (21)<sup>[10]</sup>**

PORT_TEST Mode Description	Selector Value
Test_J	1
Test_K	2
Test_SE0_NAK	3
Test_Packet	4
Test_Force_Enable	5

**Table 9. Port Indicator Selector for Feature Selector PORT\_INDICATOR (22)**

Port Indicator Color	Selector Value	Port Indicator Mode
Color set automatically as shown in <a href="#">Table 1 on page 7</a>	0	Automatic mode
Amber	1	Manual mode
Green	2	Manual mode
Off	3	Manual mode

**Note**

 10. Selector values for different features are presented in [Table 8](#).



## System Block Diagram

Figure 5. Sample Schematic for 4-port Self Powered Configuration

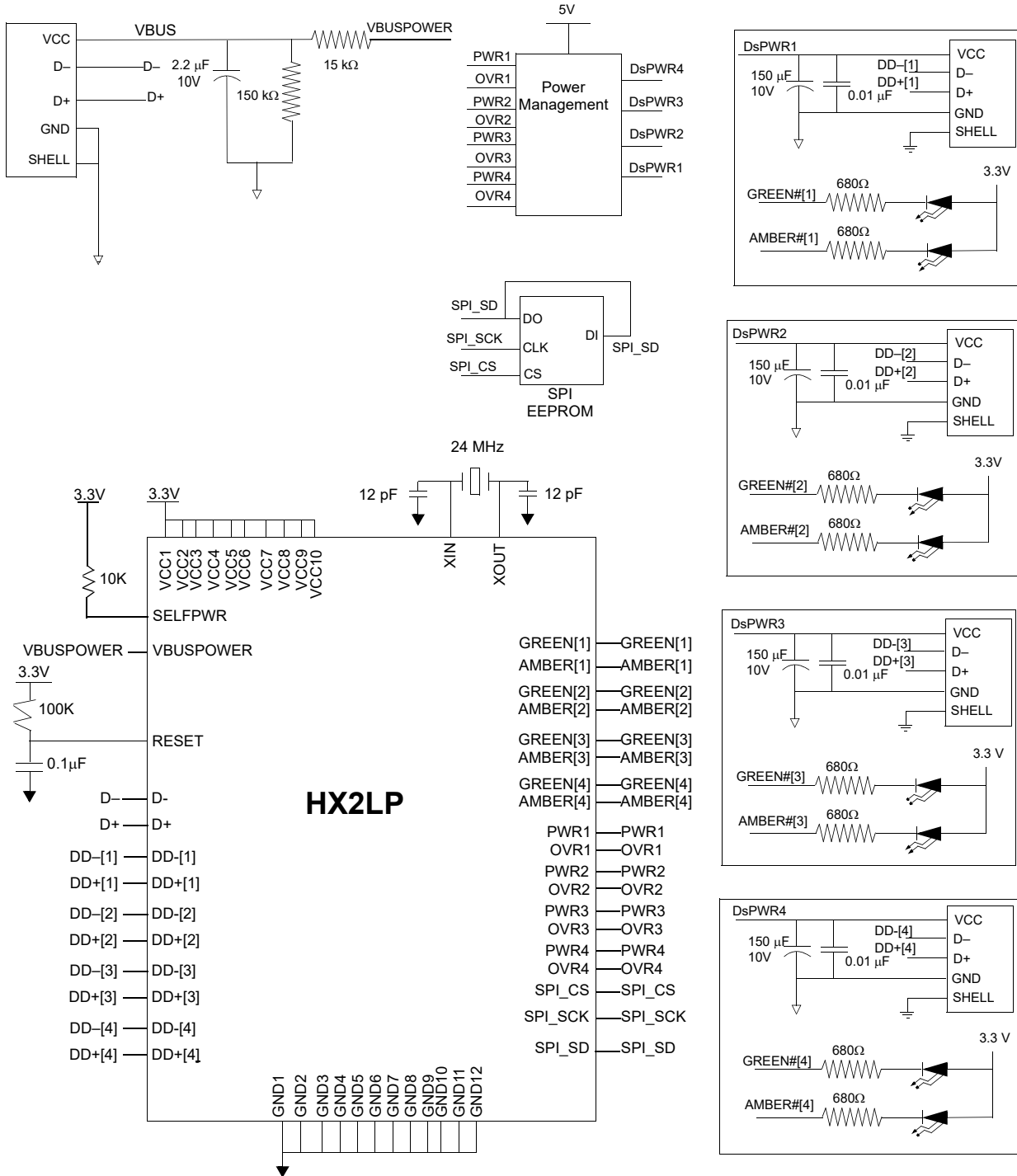

## Absolute Maximum Ratings

Exceeding maximum ratings may impair the useful life of the device. These user guidelines are not tested.

Storage temperature .....	-65 °C to +150 °C
Ambient temperature with power applied:	
Commercial .....	0 °C to +70 °C
Automotive .....	-40 °C to +85 °C
Industrial .....	-40 °C to +85 °C
Supply voltage to ground potential .....	-0.5 V to +4.0 V
DC voltage applied to outputs in high Z state .....	-0.5 V to $V_{CC} + 0.5 V$
Power dissipation (4 HS ports) .....	0.9 W
Static discharge voltage .....	> 2000 V
Maximum output sink current per I/O .....	10 mA

Reset period  
(the minimum period between when  $V_{CC}$  reaches the minimum operating voltage and de-assertion of the reset line) ..... 1.9 ms

## Operating Conditions

$T_A$ (ambient temperature under bias)	
Commercial .....	0 °C to +70 °C
Automotive .....	-40 °C to +85 °C
Industrial .....	-40 °C to +85 °C
Supply voltage .....	+3.15 V to +3.45 V
Ground voltage .....	0 V
FOSC (oscillator or crystal frequency) parallel resonant, 12 pF load capacitance, 0.5 mW .....	24 MHz $\pm$ 0.05%

## Electrical Characteristics

### DC Electrical Characteristics

Parameter	Description	Conditions	Min	Typ	Max	Unit
$V_{CC}$	Supply voltage		3.15	3.3	3.45	V
$V_{CC}$ RampUp	Ramp rate on $V_{CC}$		-	-	18	V/ms
$V_{IH}$	Input high voltage		2	-	5.25	V
$V_{IL}$	Input low voltage		-0.5	-	0.8	V
$I_I$	Input leakage current	$0 < V_{IN} < V_{CC}$	-	-	$\pm 10$	$\mu A$
$V_{OH}$	Output voltage high	$I_{OUT} = 4 \text{ mA}$	2.4	-	-	V
$V_{OL}$	Output low voltage	$I_{OUT} = -4 \text{ mA}$	-	-	0.4	V
$I_{OH}$	Output current high		-	-	4	mA
$I_{OL}$	Output current low		-	-	4	mA
$C_{IN}$	Input pin capacitance		-	-	10	pF
$I_{SUSP}$	Suspend current		-	80	-	$\mu A$
$I_{CC}$	Supply current					
	4 active ports	Full speed host, full-speed devices	-	86	110	mA
		High speed host, high-speed devices	-	231	260	mA
		High speed host, full-speed devices	-	154	180	mA
	2 active ports	Full speed host, full-speed devices	-	77	100	mA
		High speed host, high-speed devices	-	163	190	mA
		High speed host, full-speed devices	-	136	160	mA
	No active ports	Full speed host	-	65	90	mA
High speed host		-	93	120	mA	

### USB Transceiver

USB 2.0 certified in full-, low-, and high-speed modes.



**AC Electrical Characteristics**

Both the upstream USB transceiver and all four downstream transceivers have passed the USB-IF USB 2.0 Electrical Certification Testing.

*Serial Peripheral Interface***Table 10. Serial Peripheral Interface**

<b>Description</b>	<b>Min</b>	<b>Typ</b>	<b>Max</b>	<b>Unit</b>
Clock rise/fall time	–	–	500	ns
Clock frequency	–	–	250	kHz
Data setup time	50	–	–	ns
Hold time	100	–	–	ns

## Ordering Information

Ordering Code	Status	Package Type
CY7C65620-56LTXC	–	56-pin QFN 2-Port Sawn Type QFN Bulk
CY7C65620-56LTXCT	–	56-pin QFN 2-Port Sawn Type QFN Tape and Reel
CY7C65620-56LTXA	–	56-pin QFN 2-Port Automotive AEC grade
CY7C65620-56LTXAT	–	56-pin QFN 2-Port Automotive AEC grade Tape and Reel
CY7C65630-56LTXC	–	56-pin QFN 4-Port Sawn Type QFN Bulk
CY7C65630-56LTXCT	–	56-pin QFN 4-Port Sawn Type QFN Tape and Reel
CY7C65630-56LTXA	NRND*	56-pin QFN 4-Port Automotive AEC grade
CY7C65630-56LTXAT	NRND*	56-pin QFN 4-Port Automotive AEC grade Tape and Reel
CY4606	–	CY7C65630 USB 2.0 4-Port Hub Reference Design Kit
CY4605	–	CY7C65620 USB 2.0 2-Port Hub Reference Design Kit
CY7C65630-56LTXI	–	56-pin QFN 4-Port Industrial grade
CY7C65630-56LTXIT	–	56-pin QFN 4-Port Industrial grade Tape and Reel
CY7C65620-56LTXI	–	56-pin QFN 2-Port Industrial grade
CY7C65620-56LTXIT	–	56-pin QFN 2-Port Industrial grade Tape and Reel

\* Not Recommended for New Designs

### Ordering Code Definitions

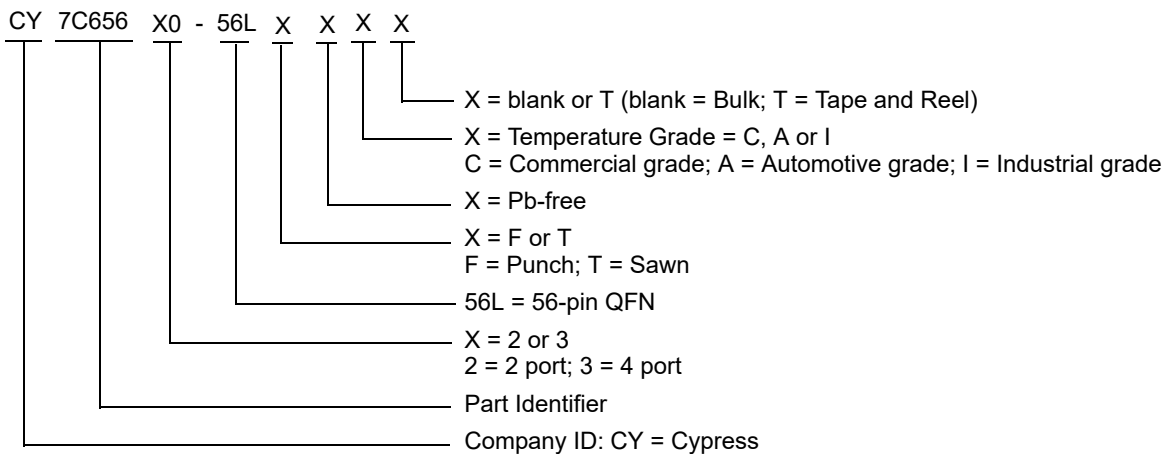

## Package Diagrams

The CY7C65620/CY7C65630 is available in a space saving 56-pin QFN (8 × 8 mm).

**Figure 6. 56-pin Sawn QFN (8 × 8 × 1.00 mm)**

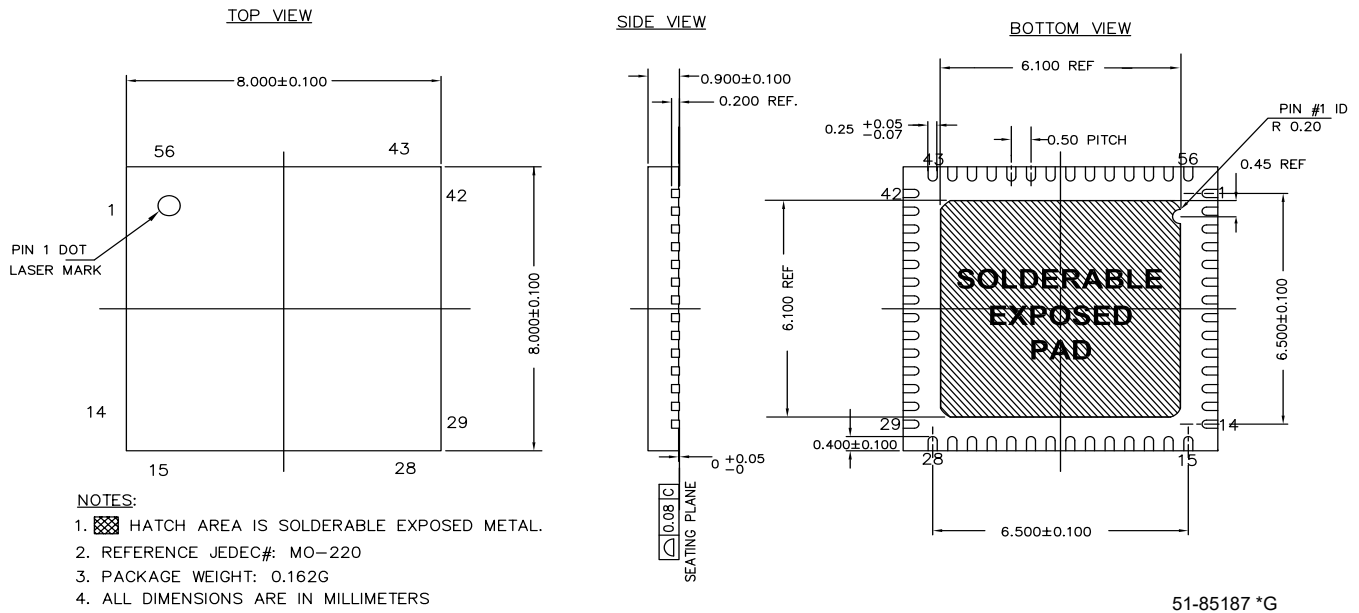

**Figure 7. 56-pin QFN 8 × 8 mm LF56A (Subcon Punch Type with 6.1 × 6.1 EPad)**

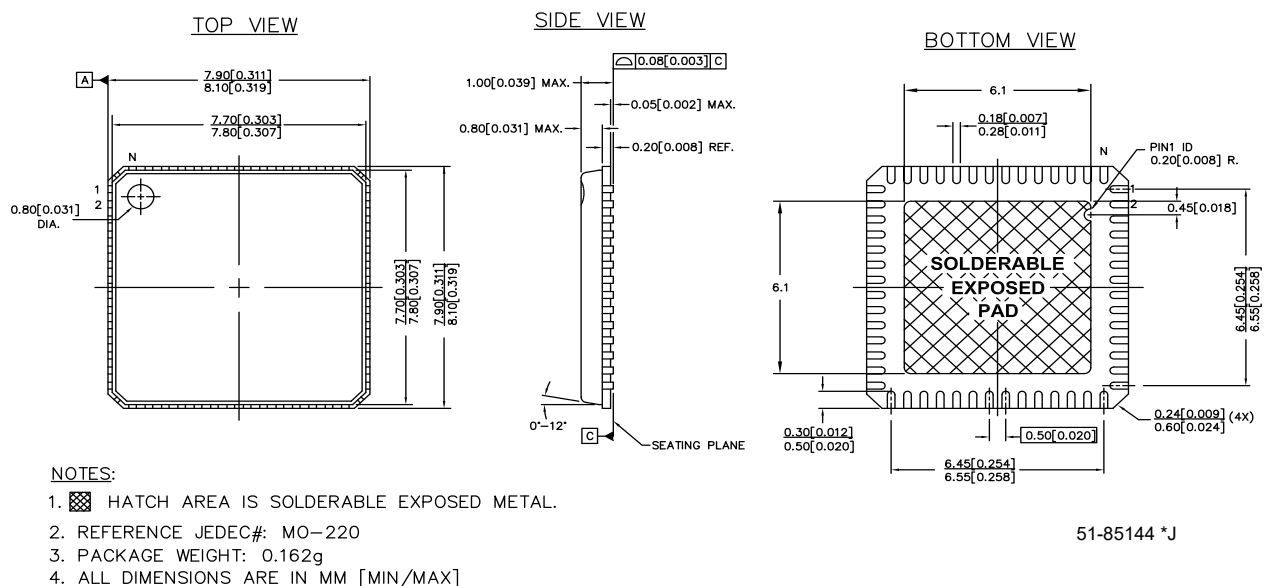

## Thermal Impedance for the Package

Package	Typical $\theta_{JA}$	Typical $\theta_{JC}$
56-pin QFN	18.4 °C/W	2.1 °C/W

## Acronyms

The following table lists the acronyms that are used in this document.

Acronym	Description
AC	alternating current
AI	analog input
AIO	analog input/output
DO	digital output
GPO	general purpose output
LSB	least significant bit
MSB	most significant bit
P	power pins
PCB	printed circuit board
PLL	phase-locked loop
POR	power-on reset
POST	power on self test
RF	radio frequency

## Document Conventions

### Units of Measure

The following table lists all the abbreviations used to measure the PSoC devices.

Symbol	Unit of Measure
°C	degree Celsius
kΩ	kilohm
μA	microampere
μs	microsecond
mA	milliampere
ms	millisecond
mV	millivolt
nA	nanoampere
Ω	ohm
pF	picofarad
V	volt

### Numeric Naming

Hexadecimal numbers are represented with all letters in uppercase with an appended lowercase 'h' (for example, '14h' or '3Ah'). Hexadecimal numbers may also be represented by a '0x' prefix, the C coding convention. Binary numbers have an appended lowercase 'b' (for example, '01010100b' or '01000011b'). Numbers not indicated by an 'h', 'b', or 0x are decimal.

## Errata

This section describes the errata for the EZ-USB HX2LP™ Low-Power USB 2.0 Hub Controller Family, CY7C65620/30. Details include errata trigger conditions, scope of impact, available workaround, and silicon revision applicability. Contact your local Cypress Sales Representative if you have questions.

### Part Numbers Affected

Part Number	Device Characteristics
CY7C65620	All Packages
CY7C65630	All Packages

### HX2LP Qualification Status

Product status: Production

### HX2LP Errata Summary

#### 1. Non-periodic and Isochronous OUT transfers in the same microframe

##### ■Description

With the operating in High-Speed mode with a Full-Speed device connected to a downstream port, Sometimes, an Isochronous OUT packet gets corrupted on the downstream port.

##### ■Implication

The main cause of this phenomenon is in the way the hub's Transaction Translator downstream handler state machine schedules transactions if non-periodic (Control or Bulk) transactions are found in the non-periodic buffer while an Isochronous OUT transaction is active on the port. If the downstream handler state machine sees an Isochronous OUT packet in the Transaction translation buffer and if it is scheduled in the same micro-frame by the host then it will skip the Isochronous OUT transaction and resume a non-periodic transaction.

##### ■Workaround

The workaround for this issue is for the host controller to avoid scheduling non-periodic traffic such that it will run while an Isochronous OUT transaction is active. Non-periodic traffic can be scheduled to run in the micro-frame before the Isochronous OUT transaction begins, or after the Isochronous OUT transaction completes.

##### ■Status

No plan to fix currently - recommend using workaround.

#### 2. Last data not received in multi-microframe Isochronous IN transfers

##### ■Description

With the hub operating in High-Speed mode with a Full-Speed device connected to a downstream port, Sometimes a multi-microframe Isochronous IN transaction resulted in the last two Complete Split transactions that should have returned data but instead returned NYET handshakes.

##### ■Implication

The main cause of this phenomenon is in the hub's Transaction Translator logic which tracks data stored in the periodic transaction buffer. If the Full-Speed transaction completes before the Complete-Split token is received from the host, there is a chance that buffer will be over-written if the requested Isochronous IN payload is greater than 440 bytes (USB 2.0 specification on buffer size).

##### ■Workaround

The workaround for this issue is for the host controller to avoid scheduling the Complete Split token for the microframe where the Full-Speed packet ends too late in the frame. The TT is guaranteed to work correctly if the Complete Split is received in the first quarter of the microframe.

##### ■Status

No plan to fix currently - recommend using workaround.

## Document History Page

Document Title: CY7C65620/CY7C65630, EZ-USB HX2LP™ Low-Power USB 2.0 Hub Controller Family				
Document Number: 38-08037				
Revision	ECN	Orig. of Change	Submission Date	Description of Change
**	131505	JTC	02/12/2004	New data sheet.
*A	231329	KKU	06/04/2004	Removed "Block Diagram – CY7C65644". Removed "Block Diagram – CY7C65641/CY7C65621". Removed "Block Diagram – CY7C65677". Added "Block Diagram – CY7C65650". Added "Block Diagram – CY7C65630". Updated <a href="#">Introduction</a> : Updated description. Added <a href="#">USB Serial Interface Engine</a> . Added <a href="#">Hub Repeater</a> . Added <a href="#">Transaction Translator</a> . Added <a href="#">Functional Overview</a> . Removed "HX2LP Pin Listing". Added <a href="#">Pin Configuration</a> . Added <a href="#">Pin Definitions</a> . Added <a href="#">Default Descriptors</a> . Added <a href="#">Configuration Options</a> . Added <a href="#">Supported USB Requests</a> . Added <a href="#">Upstream USB Connection</a> . Added <a href="#">Downstream USB Connection</a> . Added <a href="#">LED Connection</a> . Updated <a href="#">System Block Diagram</a> : Updated <a href="#">Figure 5</a> . Added <a href="#">Absolute Maximum Ratings</a> . Added <a href="#">Electrical Characteristics</a> . Added <a href="#">Operating Conditions</a> . Added <a href="#">Ordering Information</a> . Added <a href="#">Package Diagrams</a> .
*B	250869	ARI	08/30/2004	Removed "Block Diagram – CY7C65650". Removed "Block Diagram – CY7C65630". Added "Block Diagram – CY7C65640B". Added "Block Diagram – CY7C65630/CY7C65620". Updated <a href="#">Electrical Characteristics</a> : Updated <a href="#">DC Electrical Characteristics</a> : Replaced "TBD" with values in "Typ" column corresponding to I <sub>CC</sub> parameter. Updated <a href="#">Ordering Information</a> : Updated part numbers.
*C	330195	KKU	03/07/2005	Updated "Block Diagram – CY7C65640B". Updated "Block Diagram – CY7C65630/CY7C65620". Updated <a href="#">Configuration Options</a> : Added <a href="#">0xD4 Load</a> . Updated <a href="#">Supported USB Requests</a> : Updated <a href="#">Hub Class Commands</a> : Updated <a href="#">Table 6</a> : Replaced TBD with respective details under "Vendor Commands". Updated <a href="#">Electrical Characteristics</a> : Updated <a href="#">DC Electrical Characteristics</a> : Added V <sub>CC</sub> RampUp parameter and its details. Updated <a href="#">AC Electrical Characteristics</a> : Updated <a href="#">Serial Peripheral Interface</a> : Updated <a href="#">Table 10</a> : Added "Reset Period" parameter and its details.

**Document History Page** *(continued)*

Document Title: CY7C65620/CY7C65630, EZ-USB HX2LP™ Low-Power USB 2.0 Hub Controller Family				
Document Number: 38-08037				
Revision	ECN	Orig. of Change	Submission Date	Description of Change
*D	342997	KKU	04/01/2005	Updated <a href="#">Features</a> : Updated description. Updated <a href="#">Functional Overview</a> : Updated <a href="#">Enumeration</a> : Updated description. Updated <a href="#">Downstream Ports</a> : Updated description. Updated <a href="#">Power Switching</a> : Updated description. Updated <a href="#">Overcurrent Detection</a> : Updated description. Updated <a href="#">Port Indicators</a> : Updated description. Updated <a href="#">Table 1</a> . Updated <a href="#">Pin Definitions</a> : Replaced SELFPWR# with SELFPWR in "Name" column. Updated details in "Description" column corresponding to pins 26, 36, 35, 30, 29, 38, 37, 32, 31, 42, 41, 53, 54, 44, 43, 51 and 52. Updated <a href="#">Default Descriptors</a> : Updated <a href="#">Device Descriptor</a> : Updated details in "Description" column corresponding to Byte 2, 3. Updated <a href="#">Configuration Descriptor</a> : Updated details in "Description" column corresponding to Byte 7. Updated <a href="#">Configuration Options</a> : Updated description. Updated <a href="#">0xD2 Load</a> : Removed "NoEOPatEOF1" in "Value (MSB->LSB)" column corresponding to Byte 12. Updated <a href="#">0xD4 Load</a> : Updated description.
*E	498396	TEH	09/01/2006	Changed status from Preliminary to Final. Removed "HX1TT" and "Multi-TT" related information in all instances across the document. Updated <a href="#">Features</a> : Added "USB-IF Certified: TID# 30000009". Removed "Block Diagram – CY7C65640B". Removed "Block Diagram – CY7C65630/CY7C65620". Added "Block Diagram – CY7C65630". Added "Block Diagram – CY7C65620". Updated <a href="#">Configuration Options</a> : Updated <a href="#">0xD4 Load</a> : Updated description. Updated <a href="#">Upstream USB Connection</a> : Updated <a href="#">Figure 2</a> . Updated <a href="#">System Block Diagram</a> : Updated <a href="#">Figure 5</a> (to reflect latest RDK). Updated <a href="#">Ordering Information</a> : Updated part numbers. Updated to new template.

**Document History Page** *(continued)*

Document Title: CY7C65620/CY7C65630, EZ-USB HX2LP™ Low-Power USB 2.0 Hub Controller Family				
Document Number: 38-08037				
Revision	ECN	Orig. of Change	Submission Date	Description of Change
*F	570287	ARI	11/27/2006	Updated <a href="#">Pin Definitions</a> : Fixed typo (Replaced “DD-[3]” with “DD-[4]” corresponding to pin 1 and replaced “DD+[3]” with “DD+[4]” corresponding to pin 2 under “Downstream Port 4”). Updated <a href="#">Package Diagrams</a> : No change in revisions. Added dimensions of E-Pads in 51-85144 *E.
*G	852600	KKU	03/19/2007	Updated <a href="#">Features</a> : Removed “2-Port”. Added “Bus power configurations”. Updated <a href="#">Default Descriptors</a> : Updated <a href="#">Device Descriptor</a> : Updated description. Updated <a href="#">Configuration Options</a> : Updated description. Updated <a href="#">0xD4 Load</a> : Added a column “Factory Fusable” in the table and added details in that column. Updated <a href="#">System Block Diagram</a> : Updated <a href="#">Figure 5</a> .
*H	1019740	KKU / ARI	04/26/2007	Added “Automotive Temperature Range” related information in all instances across the document. Updated <a href="#">Features</a> : Added “Automotive AEC grade option (–40 °C to 85 °C)”. Updated <a href="#">Block Diagram – CY7C65630</a> . Updated <a href="#">Block Diagram – CY7C65620</a> . Updated <a href="#">Configuration Options</a> : Updated <a href="#">0xD2 Load</a> : Updated description. Updated <a href="#">Absolute Maximum Ratings</a> : Replaced “TBD” with “0.9 W” corresponding to “Power Dissipation (4 HS ports)”. Updated <a href="#">Electrical Characteristics</a> : Updated <a href="#">USB Transceiver</a> : Replaced “USB 2.0 Compliant” with “USB 2.0 Certified”. Updated <a href="#">Ordering Information</a> : Updated part numbers. Updated <a href="#">Package Diagrams</a> : No change in revisions. Removed reference of internal part numbers in 51-85144 *G.
*I	2238608	KKU	03/24/2008	Updated <a href="#">Block Diagram – CY7C65630</a> : Block diagram was altered in the *H revision, but should not have been altered. Reverted diagram to *G version. Updated <a href="#">Block Diagram – CY7C65620</a> : Block diagram was altered in the *H revision, but should not have been altered. Reverted diagram to *G version. Updated to new template.
*J	2370406	PYRS	04/14/2008	Changed status from Preliminary to Final.
*K	2657415	DPT / PYRS	02/10/2009	Updated <a href="#">Package Diagrams</a> : Added spec 51-85187 *C.
*L	2705817	GOR / PYRS	05/13/2009	Updated <a href="#">Ordering Information</a> : Updated part numbers.



**Document History Page** *(continued)*

Document Title: CY7C65620/CY7C65630, EZ-USB HX2LP™ Low-Power USB 2.0 Hub Controller Family Document Number: 38-08037				
Revision	ECN	Orig. of Change	Submission Date	Description of Change
*M	2719596	VIVG / AESA	06/16/2009	Updated <a href="#">Ordering Information</a> : Updated part numbers. Updated <a href="#">Package Diagrams</a> : spec 51-85187 – Changed revision from *C to *D.
*N	2753668	VIVG	08/19/2009	Updated <a href="#">Ordering Information</a> : Updated part numbers.
*O	2857913	VIVG	01/19/2010	Updated <a href="#">Ordering Information</a> : No change in part numbers. Fixed typo (Replaced “4-Port” with “2-Port” in “Package Type” column corresponding to CY7C65620-56LFXA and CY7C65620-56LFXAT). Updated <a href="#">Package Diagrams</a> : spec 51-85187 – Changed revision from *D to *E. spec 51-85144 – Changed revision from *G to *H.
*P	2896582	ODC	03/19/2010	Updated <a href="#">Ordering Information</a> : Updated part numbers.
*Q	3011613	ODC	08/20/2010	Updated <a href="#">Ordering Information</a> : No change in part numbers. Added <a href="#">Ordering Code Definitions</a> . Updated <a href="#">Package Diagrams</a> : No change in revisions. Added <a href="#">Thermal Impedance for the Package</a> . Added <a href="#">Document Conventions</a> . Minor edits.
*R	3095394	ODC	11/25/2010	Updated <a href="#">Supported USB Requests</a> : Updated <a href="#">Hub Class Commands</a> : Updated <a href="#">Table 8</a> . Updated <a href="#">Table 9</a> .
*S	3174789	ODC	02/16/2011	Updated <a href="#">Configuration Options</a> : Updated <a href="#">0xD2 Load</a> : Updated description. Updated <a href="#">0xD4 Load</a> : Updated description. Updated <a href="#">Package Diagrams</a> : spec 51-85144 – Changed revision from *H to *I.
*T	3252356	ODC	05/09/2011	Updated Document Title to read as “CY7C65620/CY7C65630, EZ-USB HX2LP™ Low-Power USB 2.0 Hub Controller Family”.
*U	3501907	PRVE	02/10/2012	Updated <a href="#">Ordering Information</a> : Updated part numbers. Updated <a href="#">Package Diagrams</a> : spec 51-85187 – Changed revision from *E to *F. Completing Sunset Review.
*V	3735946	PRVE	09/06/2012	Updated <a href="#">Ordering Information</a> : Updated part numbers. Updated <a href="#">Ordering Code Definitions</a> .
*W	3806343	PRJI	11/08/2012	Updated <a href="#">Pin Definitions</a> : Updated <a href="#">Table 3</a> : Updated Note 3.

**Document History Page** *(continued)*

Document Title: CY7C65620/CY7C65630, EZ-USB HX2LP™ Low-Power USB 2.0 Hub Controller Family				
Document Number: 38-08037				
Revision	ECN	Orig. of Change	Submission Date	Description of Change
*X	3830076	PRJI	12/04/2012	Updated <a href="#">Absolute Maximum Ratings</a> : Added Reset period and its details. Updated <a href="#">Electrical Characteristics</a> : Updated <a href="#">AC Electrical Characteristics</a> : Updated <a href="#">Table 10</a> : Removed Reset period and its details.
*Y	3992033	PRJI	05/06/2013	Added <a href="#">Errata</a> .
*Z	4033909	PRJI	06/19/2013	Added Errata Footnotes in all instances across the document. Updated to new template.
AA	4054137	PRJI	07/09/2013	Updated <a href="#">Ordering Information</a> : Included a column "Status" and updated the status of CY7C65620-56LFXA, CY7C65620-56LFXAT, CY7C65630-56LFXA and CY7C65630-56LFXAT as NRND.
AB	4614914	PRJI	01/06/2015	Updated <a href="#">Functional Description</a> : Added "For a complete list of related documentation, click <a href="#">here</a> ." at the end. Updated <a href="#">Default Descriptors</a> : Updated <a href="#">Configuration Descriptor</a> : Updated details in "Description" column corresponding to Byte 6 and Byte 8. Updated <a href="#">Interface Descriptor</a> : Updated details in "Description" column corresponding to Byte 2 to Byte 8. Updated <a href="#">Device Qualifier Descriptor</a> : Updated details in "Description" column corresponding to Bytes 2 to Byte 8. Updated <a href="#">Supported USB Requests</a> : Updated <a href="#">Hub Class Commands</a> : Updated <a href="#">Table 6</a> : Updated details in "Data" column corresponding to "SetHubFeature" request. Updated details in "windex" and "Data" columns corresponding to "GetHubDescriptor" request. Updated <a href="#">System Block Diagram</a> : Updated <a href="#">Figure 5</a> (removed VCC11). Updated <a href="#">Package Diagrams</a> : spec 51-85187 – Changed revision from *F to *G. spec 51-85144 – Changed revision from *I to *J. Updated to new template. Completing Sunset Review.
AC	4724071	PRJI	04/14/2015	Updated <a href="#">More Information</a> : Updated description.
AD	5526024	PRJI	11/18/2016	Updated <a href="#">Ordering Information</a> : Updated part numbers. Updated to new template.
AE	5767382	AESATMP9	06/08/2017	Updated Cypress Logo and Copyright.
AF	6145085	HBM	04/19/2018	Updated <a href="#">More Information</a> : Updated description. Updated to new template. Completing Sunset Review.
AG	6568212	HBM	05/06/2019	Updated <a href="#">Ordering Information</a> : No change in part numbers. Replaced "NRND*" with "-" in "Status" column for two MPNs (CY7C65620-56LTXA, CY7C65620-56LTXAT). Updated to new template.

## Sales, Solutions, and Legal Information

### Worldwide Sales and Design Support

Cypress maintains a worldwide network of offices, solution centers, manufacturer's representatives, and distributors. To find the office closest to you, visit us at [Cypress Locations](#).

#### Products

Arm <sup>®</sup> Cortex <sup>®</sup> Microcontrollers	<a href="http://cypress.com/arm">cypress.com/arm</a>
Automotive	<a href="http://cypress.com/automotive">cypress.com/automotive</a>
Clocks & Buffers	<a href="http://cypress.com/clocks">cypress.com/clocks</a>
Interface	<a href="http://cypress.com/interface">cypress.com/interface</a>
Internet of Things	<a href="http://cypress.com/iot">cypress.com/iot</a>
Memory	<a href="http://cypress.com/memory">cypress.com/memory</a>
Microcontrollers	<a href="http://cypress.com/mcu">cypress.com/mcu</a>
PSoC	<a href="http://cypress.com/psoc">cypress.com/psoc</a>
Power Management ICs	<a href="http://cypress.com/pmic">cypress.com/pmic</a>
Touch Sensing	<a href="http://cypress.com/touch">cypress.com/touch</a>
USB Controllers	<a href="http://cypress.com/usb">cypress.com/usb</a>
Wireless Connectivity	<a href="http://cypress.com/wireless">cypress.com/wireless</a>

#### PSoC<sup>®</sup> Solutions

[PSoC 1](#) | [PSoC 3](#) | [PSoC 4](#) | [PSoC 5LP](#) | [PSoC 6 MCU](#)

#### Cypress Developer Community

[Community](#) | [Projects](#) | [Video](#) | [Blogs](#) | [Training](#) | [Components](#)

#### Technical Support

[cypress.com/support](http://cypress.com/support)

© Cypress Semiconductor Corporation, 2004–2019. This document is the property of Cypress Semiconductor Corporation and its subsidiaries ("Cypress"). This document, including any software or firmware included or referenced in this document ("Software"), is owned by Cypress under the intellectual property laws and treaties of the United States and other countries worldwide. Cypress reserves all rights under such laws and treaties and does not, except as specifically stated in this paragraph, grant any license under its patents, copyrights, trademarks, or other intellectual property rights. If the Software is not accompanied by a license agreement and you do not otherwise have a written agreement with Cypress governing the use of the Software, then Cypress hereby grants you a personal, non-exclusive, nontransferable license (without the right to sublicense) (1) under its copyright rights in the Software (a) for Software provided in source code form, to modify and reproduce the Software solely for use with Cypress hardware products, only internally within your organization, and (b) to distribute the Software in binary code form externally to end users (either directly or indirectly through resellers and distributors), solely for use on Cypress hardware product units, and (2) under those claims of Cypress's patents that are infringed by the Software (as provided by Cypress, unmodified) to make, use, distribute, and import the Software solely for use with Cypress hardware products. Any other use, reproduction, modification, translation, or compilation of the Software is prohibited.

TO THE EXTENT PERMITTED BY APPLICABLE LAW, CYPRESS MAKES NO WARRANTY OF ANY KIND, EXPRESS OR IMPLIED, WITH REGARD TO THIS DOCUMENT OR ANY SOFTWARE OR ACCOMPANYING HARDWARE, INCLUDING, BUT NOT LIMITED TO, THE IMPLIED WARRANTIES OF MERCHANTABILITY AND FITNESS FOR A PARTICULAR PURPOSE. No computing device can be absolutely secure. Therefore, despite security measures implemented in Cypress hardware or software products, Cypress shall have no liability arising out of any security breach, such as unauthorized access to or use of a Cypress product. CYPRESS DOES NOT REPRESENT, WARRANT, OR GUARANTEE THAT CYPRESS PRODUCTS, OR SYSTEMS CREATED USING CYPRESS PRODUCTS, WILL BE FREE FROM CORRUPTION, ATTACK, VIRUSES, INTERFERENCE, HACKING, DATA LOSS OR THEFT, OR OTHER SECURITY INTRUSION (collectively, "Security Breach"). Cypress disclaims any liability relating to any Security Breach, and you shall and hereby do release Cypress from any claim, damage, or other liability arising from any Security Breach. In addition, the products described in these materials may contain design defects or errors known as errata which may cause the product to deviate from published specifications. To the extent permitted by applicable law, Cypress reserves the right to make changes to this document without further notice. Cypress does not assume any liability arising out of the application or use of any product or circuit described in this document. Any information provided in this document, including any sample design information or programming code, is provided only for reference purposes. It is the responsibility of the user of this document to properly design, program, and test the functionality and safety of any application made of this information and any resulting product. "High-Risk Device" means any device or system whose failure could cause personal injury, death, or property damage. Examples of High-Risk Devices are weapons, nuclear installations, surgical implants, and other medical devices. "Critical Component" means any component of a High-Risk Device whose failure to perform can be reasonably expected to cause, directly or indirectly, the failure of the High-Risk Device, or to affect its safety or effectiveness. Cypress is not liable, in whole or in part, and you shall and hereby do release Cypress from any claim, damage, or other liability arising from any use of a Cypress product as a Critical Component in a High-Risk Device. You shall indemnify and hold Cypress, its directors, officers, employees, agents, affiliates, distributors, and assigns harmless from and against all claims, costs, damages, and expenses, arising out of any claim, including claims for product liability, personal injury or death, or property damage arising from any use of a Cypress product as a Critical Component in a High-Risk Device. Cypress products are not intended or authorized for use as a Critical Component in any High-Risk Device except to the limited extent that (i) Cypress's published data sheet for the product explicitly states Cypress has qualified the product for use in a specific High-Risk Device, or (ii) Cypress has given you advance written authorization to use the product as a Critical Component in the specific High-Risk Device and you have signed a separate indemnification agreement.

Cypress, the Cypress logo, Spansion, the Spansion logo, and combinations thereof, WICED, PSoC, CapSense, EZ-USB, F-RAM, and Traveo are trademarks or registered trademarks of Cypress in the United States and other countries. For a more complete list of Cypress trademarks, visit [cypress.com](http://cypress.com). Other names and brands may be claimed as property of their respective owners.

# Mouser Electronics

Authorized Distributor

Click to View Pricing, Inventory, Delivery & Lifecycle Information:

[Infineon:](#)

[CY7C65620-56LTXCT](#) [CY7C65630-56LTXCT](#) [CY7C65620-56LTXI](#) [CY7C65620-56LTXIT](#) [CY7C65630-56LTXI](#)  
[CY7C65620-56LTXC](#) [CY7C65630-56LTXIT](#) [CY7C65630-56LTXC](#) [CY7C65630-56LTXA](#) [CY7C65620-56LTXA](#)