

IEC Appliance Inlet C14 with Filter, Fuseholder 1- or 2-pole, optional Voltage Selector (step switch)



Screw-on mounting from front side
 Version with ground line choke
 without voltage selector



Snap-in mounting from front side
 without voltage selector



Screw-on mounting from rear side
 without voltage selector
 Flexible wire AWG18



See below:
[Approvals and Compliances](#)

Description

- Panel mount :
 Screw-on version from front or rear side, snap-in version front side
- 4 Functions :
 Appliance Inlet Protection class I , Fuseholder for fuse-links 5 x 20 mm
 1- or 2-pole , with or without voltage selector (step switch) , Line filter
 in standard and medical version
- V-Lock notch standard
- Quick connect terminals / wires

Unique Selling Proposition

- Reduces noise on the ground wire
- Interrupts ground loops
- High asymmetrical attenuation
- V-Lock cord retaining

Characteristics

- Rear side mounting for efficient cost-saving assembly
- Suitable for assembly in metal plated plastic housings
- All single elements are already wired
- Plug removal necessary for fuse-link replacement
- Suitable for use in medical equipment according to IEC/UL 60601-1 (1 MOOP, 1 MOPP)
 For applications according IEC/UL 62368-1 we recommend variants with bleed resistor

Other versions on request

- Capacity CX 100 nF

References

Alternative: version without line filter [KEA](#)

Weblinks

[pdf data sheet](#), [html datasheet](#), [General Product Information](#), [Approvals](#), [Distributor-Stock-Check](#), [Accessories](#), [Detailed request for product](#), [Microsite](#)

Technical Data

Ratings IEC	1 - 10A @ Ta 40 °C / 250VAC; 50Hz	Appliance inlet/-outlet	C14 acc. to IEC 60320-1, UL 498, CSA C22.2 no. 42 (for cold conditions) pin-temperature 70 °C, 10A, Protection Class I
Ratings UL/CSA	1 - 10A @ Ta 40 °C / 250VAC; 60Hz	Fuseholder	1-/2-pole, Shocksafe category PC2 acc. to IEC 60127-6, for fuse-links 5 x 20mm
Leakage Current	standard < 0.5 mA (250 V / 60Hz) medical < 5 µA (250 V / 60 Hz)	Rated Power Acceptance @ Ta 23 °C	5 x 20: 2W (1 pole)/ 1.6W (2-pole) per pole
Dielectric Strength	> 1.7 kVDC between L-N > 2.7 kVDC between L/N-PE Test voltage (2 sec)	Power Acceptance @ Ta > 23°C	Admissible power acceptance at higher ambient temperature see derating curves
Allowable Operation Temperature	-25 °C to 85 °C	Voltage Selector	optional, step, 3 pos.
Climatic Category	25/085/21 acc. to IEC 60068-1	Line Filter	Standard and Medical Version, IEC 60939, UL 1283, CSA C22.2 no. 8 Technical Details
IP-Protection	front side IP40 acc. to IEC 60529	MTBF	> 1'700'000h acc. to MIL-HB-217 F
Protection Class	Suitable for appliances with protection class I acc. to IEC 61140		
Terminal	Quick connect terminals 6.3 x 0.8 mm Flexible wire AWG18, 150 mm		
Panel Thickness S	Screw: max 8 mm Mounting screw torque max 0.5Nm Snap-in: 0.8mm to 3mm		
Material: Housing	Thermoplastic, black, UL 94V-0		

Approvals and Compliances



Detailed information on product approvals, code requirements, usage instructions and detailed test conditions can be looked up in [Details about Approvals](#)

SCHURTER products are designed for use in industrial environments. They have approvals from independent testing bodies according to national and international standards. Products with specific characteristics and requirements such as required in the automotive sector according to IATF 16949, medical technology according to ISO 13485 or in the aerospace industry can be offered exclusively with customer-specific, individual agreements by SCHURTER.

Approvals









The approval mark is used by the testing authorities to certify compliance with the safety requirements placed on electronic products.

Approval Reference Type: KFA

Approval Logo	Certificates	Certification Body	Description
	VDE Approvals	VDE	Certificate Number: 40004665 (FKE, FKf, FKV, FKW)
	UL Approvals	UL	UL File Number: E72928 (FKE, FKf, FKV, FKW)
	CQC Approvals	CQC	CQC Certificate Number: CQC18001188536



Product standards

Product standards that are referenced

Organization	Design	Standard	Description
	Designed according to	IEC 60320-1	Appliance couplers for household and similar general purposes
	Designed according to	IEC 60939	Passive filters for suppressing electromagnetic interference
	Designed according to	IEC 60127-6	Miniature fuses. Part 6. Fuse-holders for miniature fuse-links
	Designed according to	IEC 61058-1	Switches for appliances. Part 1. General requirements
	Designed according to	UL 498	Standard for Attachment Plugs and Receptacles
	Designed according to	UL 1283	Electromagnetic interference filters
	Designed according to	CSA C22.2 no. 42	General Use Receptacles, Attachment Plugs, and Similar Wiring Devices
	Designed according to	CSA C22.2 no. 8	Electromagnetic interference (EMI) filters









Application standards

Application standards where the product can be used

Organization	Design	Standard	Description
	Designed for applications acc.	IEC/UL 62368-1	Audio/video, information and communication technology equipment - Part 1: Safety requirements
	Designed for applications acc.	IEC 60601-1	Medical electrical equipment - Part 1: General requirements for basic safety and essential performance
	Designed for applications acc.	IEC 60335-1	Safety of electrical appliances for household and similar purposes. Meets the requirements for appliances in unattended use. This includes the enhanced requirements of glow wire tests acc. to IEC 60695-2-11 or -12 & -13.

Compliances

The product complies with following Guide Lines

Identification	Details	Initiator	Description
	CE declaration of conformity	SCHURTER AG	The CE marking declares that the product complies with the applicable requirements laid down in the harmonisation of Community legislation on its affixing in accordance with EU Regulation 765/2008.
	UKCA declaration of conformity	SCHURTER AG	The UKCA marking declares that the product complies with the applicable requirements laid down in the British Amendment of Regulation (EC) 765/2008.
	RoHS	SCHURTER AG	Directive RoHS 2011/65/EU, Amendment (EU) 2015/863
	China RoHS	SCHURTER AG	The law SJ / T 11363-2006 (China RoHS) has been in force since 1 March 2007. It is similar to the EU directive RoHS.
	REACH	SCHURTER AG	On 1 June 2007, Regulation (EC) No 1907/2006 on the Registration, Evaluation, Authorization and Restriction of Chemicals 1 (abbreviated as "REACH") entered into force.
		SCHURTER AG	V-Lock system are based on a matching plug-dose combination. The connector is equipped with a notch intended for use with the latching cordset. The cord latching system prevents against accidental removal of the cordset.
	White Paper Glow wire test	SCHURTER AG	Meets the requirements of IEC 60335-1 for appliances in unattended use. This includes the enhanced requirements of glow wire tests acc. to IEC 60695-2-11 or -12 & -13.
	Medical Equipment	SCHURTER AG	Suitable for use in medical equipment according to IEC/UL 60601-1 (1 MOPP, 1 MOPP)

Dimension [mm]
 Filter with voltage selector

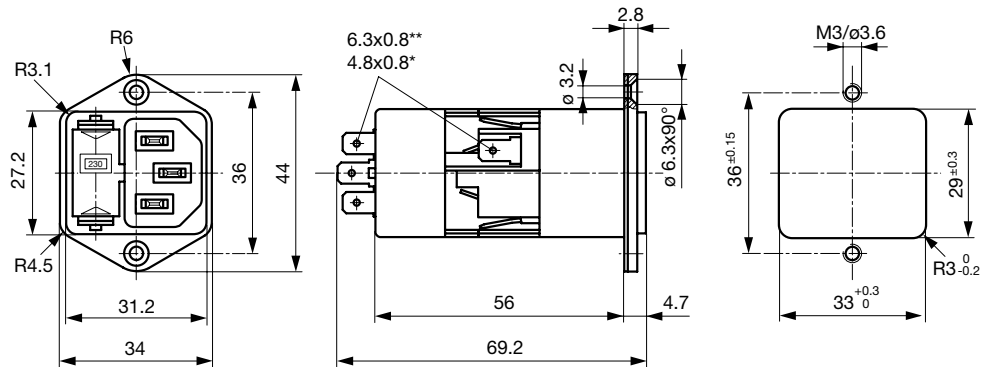

Screw-on mounting from rear side

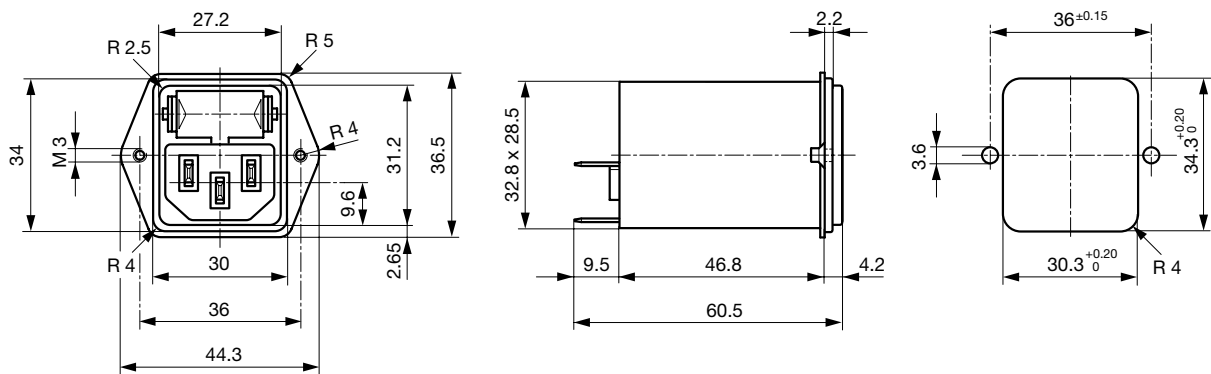

Snap-in mounting

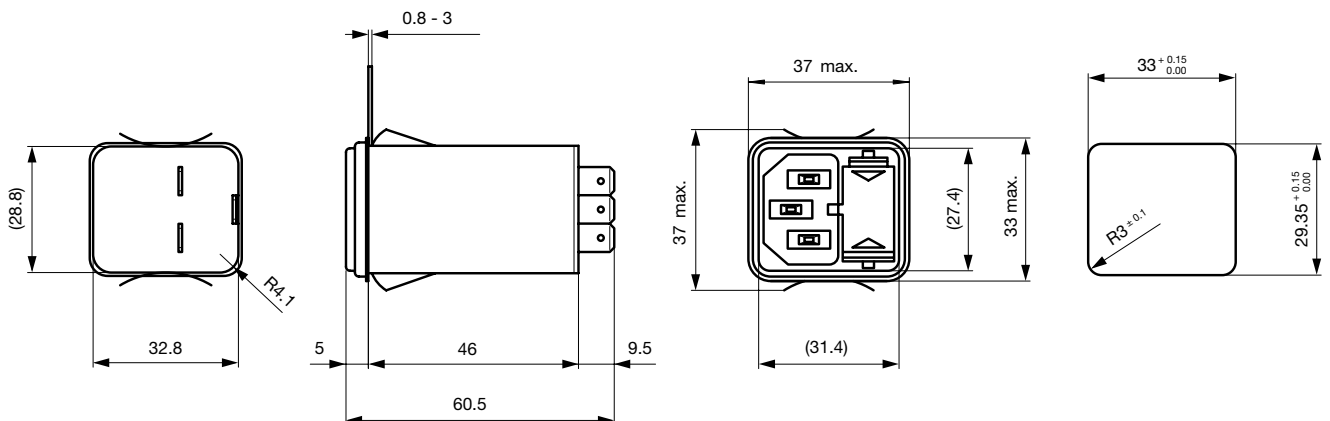

Screw-on mounting from front side with ground line choke

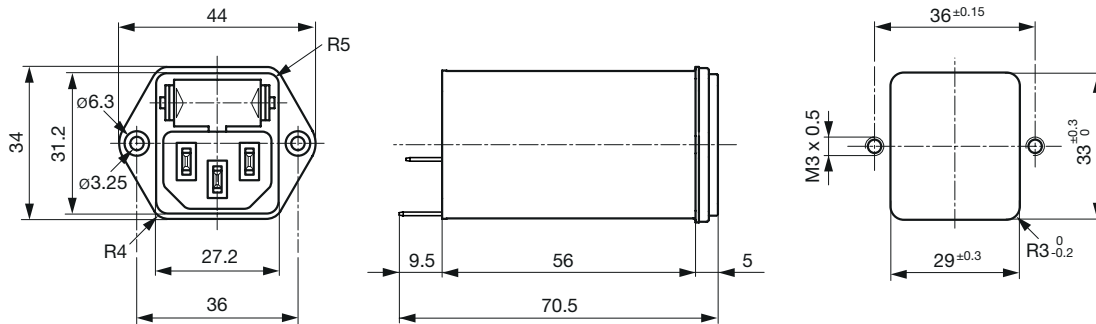

Screw-on mounting from front side

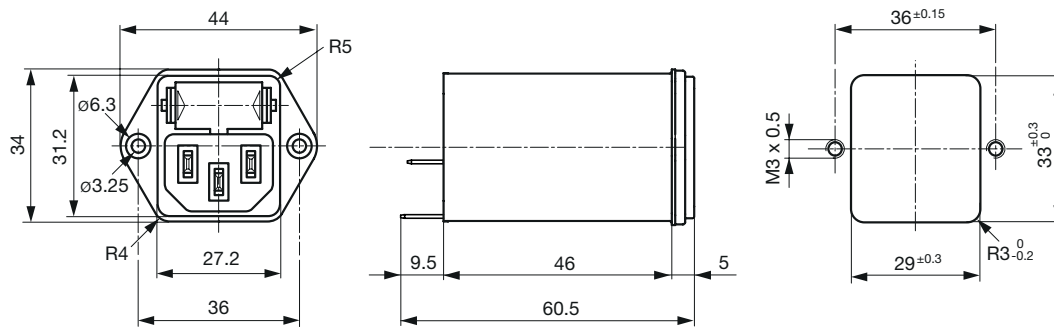

Technical Data of Filter-Components

Rated Current [A]	Filter-Type	Inductance L1/ L2 [mH]	Inductance L3 [mH]	Capacitance CX [nF]	Capacitance CY [nF]	R [MΩ]
1	Standard version	2 x 10	-	68	2.2	-
2	Standard version	2 x 4	-	68	2.2	-
4	Standard version	2 x 1.5	-	68	2.2	-
6	Standard version	2 x 0.8	-	68	2.2	-
10	Standard version	2 x 0.3	-	68	2.2	-
1	Standard Version with Ground Line Choke	2 x 10	0.6	100	2.2	-
2	Standard Version with Ground Line Choke	2 x 4	0.6	100	2.2	-
4	Standard Version with Ground Line Choke	2 x 1.5	0.6	100	2.2	-
6	Standard Version with Ground Line Choke	2 x 0.8	0.6	100	2.2	-
10	Standard Version with Ground Line Choke	2 x 0.3	0.15	100	2.2	-
1	Medical Version (M5)	2 x 10	-	68	-	1
2	Medical Version (M5)	2 x 4	-	68	-	1
4	Medical Version (M5)	2 x 1.5	-	68	-	1
6	Medical Version (M5)	2 x 0.8	-	68	-	1
10	Medical Version (M5)	2 x 0.3	-	68	-	1
1	Medical Version (M80)	2 x 10	-	68	0.47	1
2	Medical Version (M80)	2 x 4	-	68	0.47	1
4	Medical Version (M80)	2 x 1.5	-	68	0.47	1
6	Medical Version (M80)	2 x 0.8	-	68	0.47	1

Rated Current [A]	Filter-Type	Inductance L1/ L2 [mH]	Inductance L3 [mH]	Capacitance CX [nF]	Capacitance CY [nF]	R [MΩ]
10	Medical Version (M80)	2 x 0.3	-	68	0.47	1
1	Medical Version (M5) with Ground Line Choke	2 x 10	0.6	100	-	1
2	Medical Version (M5) with Ground Line Choke	2 x 4	0.6	100	-	1
4	Medical Version (M5) with Ground Line Choke	2 x 1.5	0.6	100	-	1
6	Medical Version (M5) with Ground Line Choke	2 x 0.8	0.6	100	-	1
10	Medical Version (M5) with Ground Line Choke	2 x 0.3	0.15	100	-	1

Diagrams

Standard version
with voltage selector

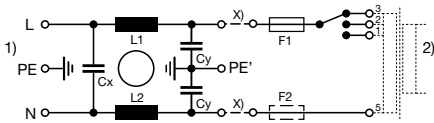

x) external connection to be made by the customer
 1) Line
 2) Load

Standard version
without voltage selector

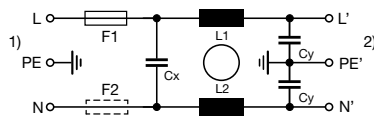

1) Line
 2) Load

Medical Version (M5)
with voltage selector

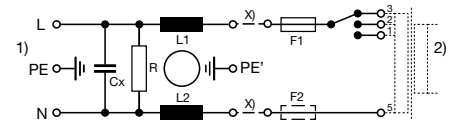

x) external connection to be made by the customer
 1) Line
 2) Load

Medical Version (M5)
without voltage selector

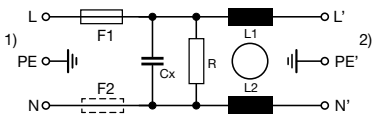

1) Line
 2) Load

Medical Version (M80)
with voltage selector

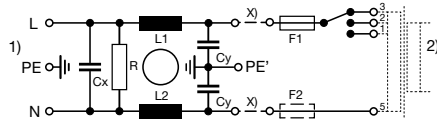

x) external connection to be made by the customer
 1) Line
 2) Load

Medical Version (M80)
without voltage selector

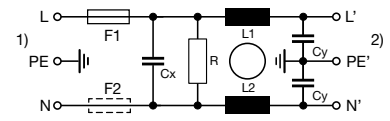

1) Line
 2) Load

Standard version with ground line choke

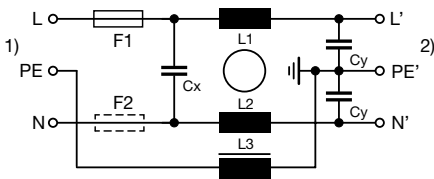

1) Line
 2) Load

Medical Version (M5) with ground line choke

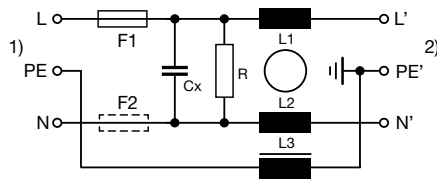

1) Line
 2) Load

Medical Version (M80) with ground line choke

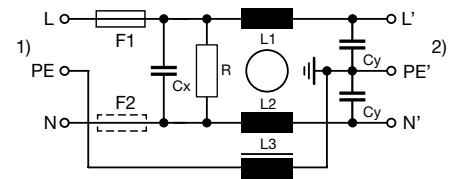

1) Line
 2) Load

Derating Curves

1-pole

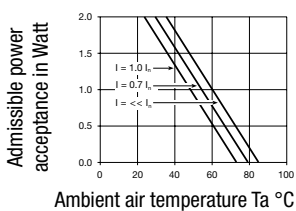

2-pole

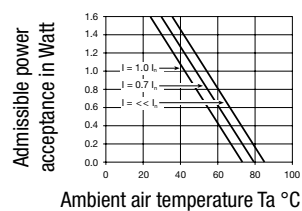

Attenuation Loss

--- 50Ω differential mode ____ 50Ω common mode

Standard version

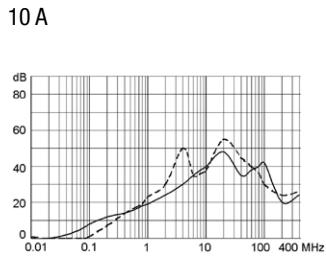
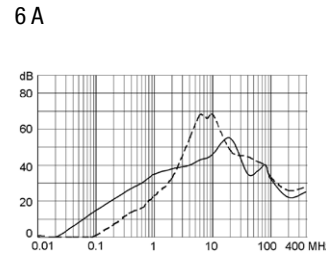
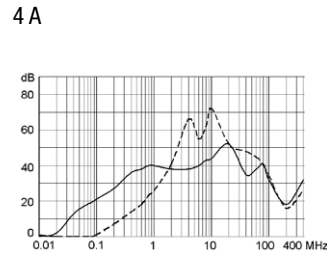
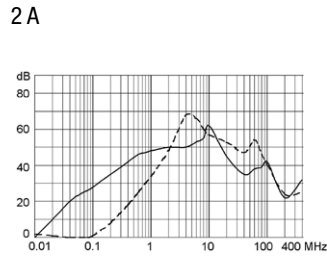
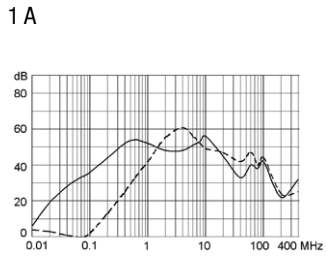

Medical version (M5)

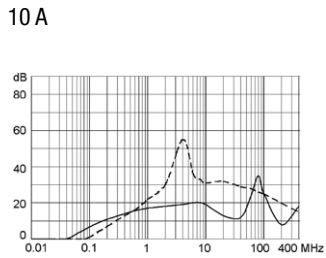
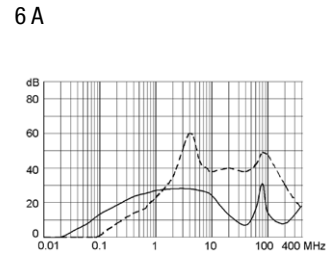
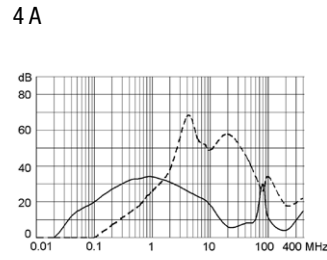
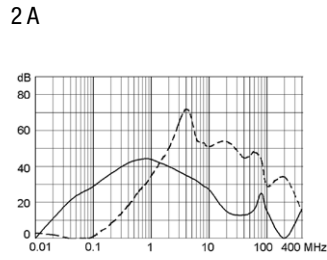
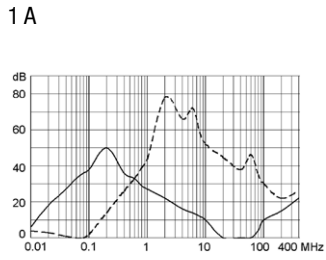

Medical version (M80)

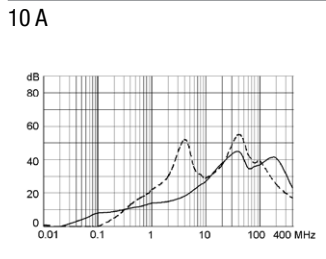
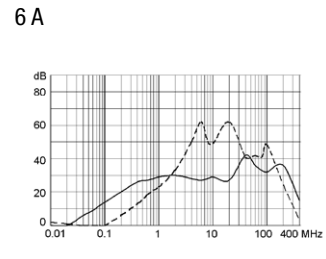
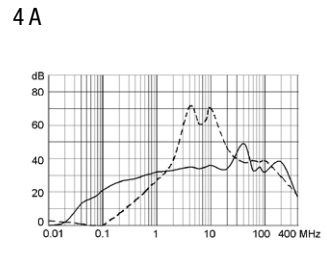
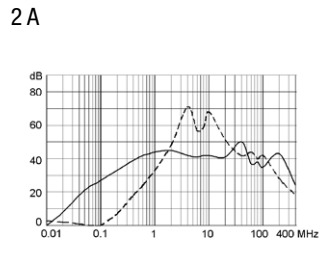
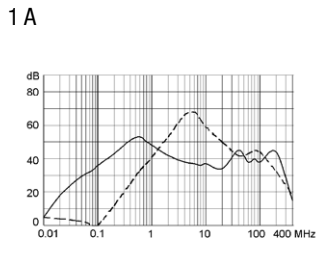

Standard with Earth Line Choke

1 A

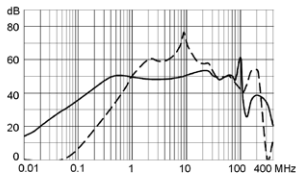

2 A

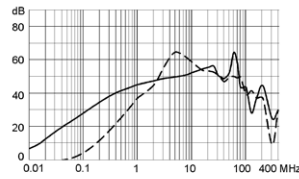

4 A

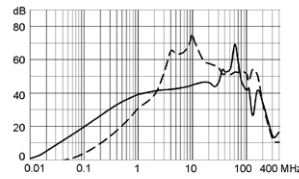

6 A

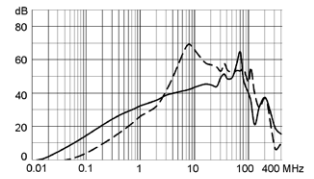

10 A

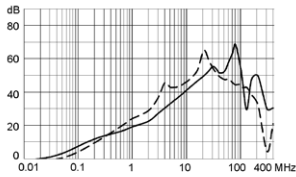

Medical (M5) with Earth Line Choke

1 A

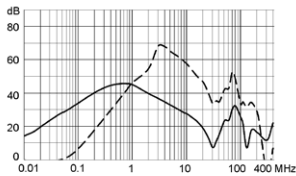

2 A

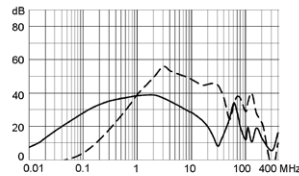

4 A

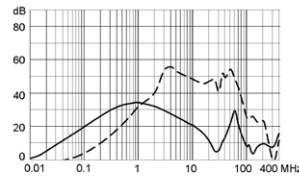

6 A

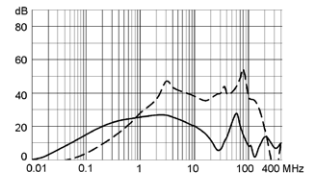

10 A

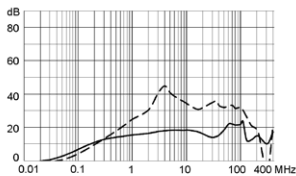

All Variants

Rated Current [A]	Filter-Type	Panel mounting	Mounting side	Fuseholder	Terminal	Voltage Selector	Order Number
1	Standard version	Snap-in	Front Side	1-pole	Quick connect terminals 6.3 x 0.8 mm	-	4301.6011
1	Standard version	Snap-in	Front Side	2-pole	Quick connect terminals 6.3 x 0.8 mm	-	4301.6001
2	Standard version	Snap-in	Front Side	1-pole	Quick connect terminals 6.3 x 0.8 mm	-	4301.6012
2	Standard version	Snap-in	Front Side	2-pole	Quick connect terminals 6.3 x 0.8 mm	-	4301.6002
4	Standard version	Snap-in	Front Side	1-pole	Quick connect terminals 6.3 x 0.8 mm	-	4301.6013
4	Standard version	Snap-in	Front Side	2-pole	Quick connect terminals 6.3 x 0.8 mm	-	4301.6003
6	Standard version	Snap-in	Front Side	1-pole	Quick connect terminals 6.3 x 0.8 mm	-	4301.6014
6	Standard version	Snap-in	Front Side	2-pole	Quick connect terminals 6.3 x 0.8 mm	-	4301.6004
10	Standard version	Snap-in	Front Side	1-pole	Quick connect terminals 6.3 x 0.8 mm	-	4301.6015
10	Standard version	Snap-in	Front Side	2-pole	Quick connect terminals 6.3 x 0.8 mm	-	4301.6005

Rated Current [A]	Filter-Type	Panel mounting	Mounting side	Fuseholder	Terminal	Voltage Selector	Order Number
1	Standard version	Screw	Front Side	1-pole	Quick connect terminals 6.3 x 0.8 mm	-	4301.5011
1	Standard version	Screw	Front Side	1-pole	Quick connect terminals 6.3 x 0.8 mm	3 pos.	4301.5051
1	Standard version	Screw	Front Side	2-pole	Quick connect terminals 6.3 x 0.8 mm	-	4301.5001
1	Standard version	Screw	Front Side	2-pole	Quick connect terminals 6.3 x 0.8 mm	3 pos.	4301.5041
1	Standard version	Screw	Rear Side	1-pole	Flexible wire AWG18	-	4301.7311
1	Standard version	Screw	Rear Side	2-pole	Flexible wire AWG18	-	4301.7301
1	Standard version	Screw	Rear Side	2-pole	Quick connect terminals 6.3 x 0.8 mm	-	4301.7001
2	Standard version	Screw	Front Side	1-pole	Quick connect terminals 6.3 x 0.8 mm	-	4301.5012
2	Standard version	Screw	Front Side	1-pole	Quick connect terminals 6.3 x 0.8 mm	3 pos.	4301.5052
2	Standard version	Screw	Front Side	2-pole	Quick connect terminals 6.3 x 0.8 mm	-	4301.5002
2	Standard version	Screw	Front Side	2-pole	Quick connect terminals 6.3 x 0.8 mm	3 pos.	4301.5042
2	Standard version	Screw	Rear Side	2-pole	Quick connect terminals 6.3 x 0.8 mm	-	4301.7002
4	Standard version	Screw	Front Side	1-pole	Quick connect terminals 6.3 x 0.8 mm	-	4301.5013
4	Standard version	Screw	Front Side	1-pole	Quick connect terminals 6.3 x 0.8 mm	3 pos.	4301.5053
4	Standard version	Screw	Front Side	2-pole	Quick connect terminals 6.3 x 0.8 mm	-	4301.5003
4	Standard version	Screw	Front Side	2-pole	Quick connect terminals 6.3 x 0.8 mm	3 pos.	4301.5043
4	Standard version	Screw	Rear Side	1-pole	Quick connect terminals 6.3 x 0.8 mm	-	4301.7013
4	Standard version	Screw	Rear Side	2-pole	Quick connect terminals 6.3 x 0.8 mm	-	4301.7003
6	Standard version	Screw	Front Side	1-pole	Quick connect terminals 6.3 x 0.8 mm	-	4301.5014
6	Standard version	Screw	Front Side	1-pole	Quick connect terminals 6.3 x 0.8 mm	3 pos.	4301.5054
6	Standard version	Screw	Front Side	2-pole	Quick connect terminals 6.3 x 0.8 mm	-	4301.5004
6	Standard version	Screw	Front Side	2-pole	Quick connect terminals 6.3 x 0.8 mm	3 pos.	4301.5044
6	Standard version	Screw	Rear Side	1-pole	Quick connect terminals 6.3 x 0.8 mm	-	4301.7014
6	Standard version	Screw	Rear Side	2-pole	Quick connect terminals 6.3 x 0.8 mm	-	4301.7004
10	Standard version	Screw	Front Side	1-pole	Quick connect terminals 6.3 x 0.8 mm	-	4301.5015
10	Standard version	Screw	Front Side	1-pole	Quick connect terminals 6.3 x 0.8 mm	3 pos.	4301.5055
10	Standard version	Screw	Front Side	2-pole	Quick connect terminals 6.3 x 0.8 mm	-	4301.5005
10	Standard version	Screw	Front Side	2-pole	Quick connect terminals 6.3 x 0.8 mm	3 pos.	4301.5045
10	Standard version	Screw	Rear Side	1-pole	Quick connect terminals 6.3 x 0.8 mm	-	4301.7015
10	Standard version	Screw	Rear Side	2-pole	Quick connect terminals 6.3 x 0.8 mm	-	4301.7005
1	Standard Version with Ground Line Choke	Screw	Front Side	2-pole	Quick connect terminals 6.3 x 0.8 mm	-	4301.8050
2	Standard Version with Ground Line Choke	Screw	Front Side	2-pole	Quick connect terminals 6.3 x 0.8 mm	-	4301.8051
4	Standard Version with Ground Line Choke	Screw	Front Side	2-pole	Quick connect terminals 6.3 x 0.8 mm	-	4301.8052
6	Standard Version with Ground Line Choke	Screw	Front Side	2-pole	Quick connect terminals 6.3 x 0.8 mm	-	4301.8053

Rated Current [A]	Filter-Type	Panel mounting	Mounting side	Fuseholder	Terminal	Voltage Selector	Order Number
10	Standard Version with Ground Line Choke	Screw	Front Side	2-pole	Quick connect terminals 6.3 x 0.8 mm	-	4301.8054
1	Medical Version (M5)	Snap-in	Front Side	2-pole	Quick connect terminals 6.3 x 0.8 mm	-	4301.6201
2	Medical Version (M5)	Snap-in	Front Side	2-pole	Quick connect terminals 6.3 x 0.8 mm	-	4301.6203
4	Medical Version (M5)	Snap-in	Front Side	2-pole	Quick connect terminals 6.3 x 0.8 mm	-	4301.6205
6	Medical Version (M5)	Snap-in	Front Side	2-pole	Flexible wire AWG18	-	4301.6307
6	Medical Version (M5)	Snap-in	Front Side	2-pole	Quick connect terminals 6.3 x 0.8 mm	-	4301.6207
1	Medical Version (M5)	Screw	Front Side	2-pole	Quick connect terminals 6.3 x 0.8 mm	3 pos.	4301.5241
1	Medical Version (M5)	Screw	Rear Side	2-pole	Quick connect terminals 6.3 x 0.8 mm	-	4301.7201
2	Medical Version (M5)	Screw	Front Side	2-pole	Quick connect terminals 6.3 x 0.8 mm	-	4301.5203
2	Medical Version (M5)	Screw	Front Side	2-pole	Quick connect terminals 6.3 x 0.8 mm	3 pos.	4301.5243
2	Medical Version (M5)	Screw	Rear Side	2-pole	Quick connect terminals 6.3 x 0.8 mm	-	4301.7203
4	Medical Version (M5)	Screw	Front Side	2-pole	Quick connect terminals 6.3 x 0.8 mm	-	4301.5205
4	Medical Version (M5)	Screw	Front Side	2-pole	Quick connect terminals 6.3 x 0.8 mm	3 pos.	4301.5245
4	Medical Version (M5)	Screw	Rear Side	2-pole	Quick connect terminals 6.3 x 0.8 mm	-	4301.7205
6	Medical Version (M5)	Screw	Front Side	1-pole	Quick connect terminals 6.3 x 0.8 mm	-	4301.5217
6	Medical Version (M5)	Screw	Front Side	2-pole	Quick connect terminals 6.3 x 0.8 mm	-	4301.5207
6	Medical Version (M5)	Screw	Front Side	2-pole	Quick connect terminals 6.3 x 0.8 mm	3 pos.	4301.5247
6	Medical Version (M5)	Screw	Rear Side	2-pole	Quick connect terminals 6.3 x 0.8 mm	-	4301.7207
10	Medical Version (M5)	Screw	Front Side	2-pole	Quick connect terminals 6.3 x 0.8 mm	-	4301.5209
10	Medical Version (M5)	Screw	Rear Side	2-pole	Quick connect terminals 6.3 x 0.8 mm	-	4301.7209
4	Medical Version (M80)	Snap-in	Front Side	2-pole	Quick connect terminals 6.3 x 0.8 mm	-	4301.6206
1	Medical Version (M80)	Screw	Rear Side	2-pole	Quick connect terminals 6.3 x 0.8 mm	-	4301.7202
2	Medical Version (M80)	Screw	Front Side	2-pole	Quick connect terminals 6.3 x 0.8 mm	-	4301.5204
2	Medical Version (M80)	Screw	Front Side	2-pole	Quick connect terminals 6.3 x 0.8 mm	3 pos.	4301.5244
2	Medical Version (M80)	Screw	Rear Side	2-pole	Quick connect terminals 6.3 x 0.8 mm	-	4301.7204
4	Medical Version (M80)	Screw	Front Side	2-pole	Quick connect terminals 6.3 x 0.8 mm	-	4301.5206
4	Medical Version (M80)	Screw	Rear Side	2-pole	Quick connect terminals 6.3 x 0.8 mm	-	4301.7206
6	Medical Version (M80)	Screw	Front Side	2-pole	Quick connect terminals 6.3 x 0.8 mm	-	4301.5208
6	Medical Version (M80)	Screw	Rear Side	2-pole	Quick connect terminals 6.3 x 0.8 mm	-	4301.7208
10	Medical Version (M80)	Screw	Front Side	2-pole	Quick connect terminals 6.3 x 0.8 mm	-	4301.5200
10	Medical Version (M80)	Screw	Rear Side	2-pole	Quick connect terminals 6.3 x 0.8 mm	-	4301.7200
1	Medical Version (M5) with Ground Line Choke	Screw	Front Side	2-pole	Quick connect terminals 6.3 x 0.8 mm	-	4301.8055
2	Medical Version (M5) with Ground Line Choke	Screw	Front Side	2-pole	Quick connect terminals 6.3 x 0.8 mm	-	4301.8056
4	Medical Version (M5) with Ground Line Choke	Screw	Front Side	2-pole	Quick connect terminals 6.3 x 0.8 mm	-	4301.8057

Rated Current [A]	Filter-Type	Panel mounting	Mounting side	Fuseholder	Terminal	Voltage Selector	Order Number
6	Medical Version (M5) with Ground Line Choke	Screw	Front Side	2-pole	Quick connect terminals 6.3 x 0.8 mm	-	4301.8058
10	Medical Version (M5) with Ground Line Choke	Screw	Front Side	2-pole	Quick connect terminals 6.3 x 0.8 mm	-	4301.8059

Most Popular:

Availability for all products can be searched real-time: <https://www.schurter.com/en/Stock-Check/Stock-Check-SCHURTER>

Wire length: 150 mm

The fuse drawer is not included and must be ordered separately (see required accessory).

Packaging unit	10 Pcs
-----------------------	--------

Required Accessory

Description

Fusedrawer 2
 Fusedrawer for Fuse Links 5x20 mm, with or without Voltage Selector Insert



Fingergrip-Safe, 2-pole	3-104-672
Fingergrip, 2-pole, Voltage Selector, 110, 150, 220	4301.1014.01
Fingergrip, 2-pole, Voltage Selector, 120, 240	4301.1014.02
Fingergrip, 2-pole, Voltage Selector, 110, 220	4301.1014.03
...	...

Accessories



Wire Harness
 Wire harness for SCHURTER products



Assorted Covers
 Rear Cover

	0859.0072
--	-----------



RC320
 Rear Cover for Power Entry Module



[Cord retaining kits](#)
 Cord retaining strain relief

Flat head, A	4700.0001
Countersunk, B	4700.0002

Mating Outlets/Connectors

Category / Description

[Appliance Outlet Overview complete](#)



4787, Mounting: Screw-on mounting, Appliance Outlet: IEC Solder terminals, 10 A, Suitable for appliances with protection class I	4787
4788, Mounting: Snap-in version, Appliance Outlet: IEC Solder / Quick Connect, 10 A, Suitable for appliances with protection class I	4788
IEC Appliance Outlet F or H, Screw-on Mounting, Front Side, Solder, PCB or Quick-connect Terminal	5091

[Connector Overview complete](#)



4782 Mounting: Power Cord, 3 x 1 mm ² / 3 x 18 AWG, Cable, Connector: IEC C13	4782
4785 Mounting: Power Cord, 3 x 1 mm ² / 3 x 18 AWG, Cable, Connector: IEC C13	4785
4300-06 Mounting: Power Cord, 3 x 1 mm ² / 3 x 18 AWG, Cable, Connector: IEC C13	4300-06
4781 Mounting: Power Cord, Cable, Connector: IEC C15	4781
4784 Mounting: Power Cord, 3 x 1 mm ² / 3 x 18 AWG, Cable, Connector: IEC C15	4784

...

Mating Outlets/Connectors shuttered



[Connector Overview complete](#)

4783 Mounting: Power Cord, 3 x 1 mm ² / 3 x 18 AWG, Cable, Connector: IEC C13	4783
--	------



[Power Cord Overview complete](#)

VAC13KS, Overview, V-Lock cord retaining, diverse Connector IEC C13, diverse, black	VAC13KS
---	---------

Mouser Electronics

Authorized Distributor

Click to View Pricing, Inventory, Delivery & Lifecycle Information:

Schurter:

[4301.5015](#) [4301.6012](#) [4301.6014](#) [4301.6013](#) [4301.6015](#) [4301.6011](#) [4301.6004](#) [4301.6002](#) [4301.6005](#) [4301.6001](#)
[4301.6003](#) [4301.6203](#) [4301.6205](#) [4301.6201](#) [4301.5005](#) [4301.5001](#) [4301.5002](#) [4301.5003](#) [4301.5003.01](#)
[4301.5004](#) [4301.5011](#) [4301.5012](#) [4301.5013](#) [4301.5014](#) [4301.5041](#) [4301.5042](#) [4301.5043](#) [4301.5044](#) [4301.5045](#)
[4301.5051](#) [4301.5052](#) [4301.5053](#) [4301.5054](#) [4301.5055](#) [4301.5201](#) [4301.5202](#) [4301.5203](#) [4301.5204](#) [4301.5205](#)
[4301.5206](#) [4301.5208](#) [4301.5209](#) [4301.5214](#) [4301.5217](#) [4301.5241](#) [4301.5243](#) [4301.5244](#) [4301.5245](#) [4301.5246](#)
[4301.5247](#) [4301.5249](#) [4301.6206](#) [4301.6207](#) [4301.6209](#) [4301.6013.01](#) [4301.6304.01](#) [4301.6307](#) [4301.7011](#)
[4301.7012](#) [4301.7013](#) [4301.7014](#) [4301.7015](#) [4301.7201](#) [4301.7202](#) [4301.7203](#) [4301.7204](#) [4301.7205](#) [4301.7206](#)
[4301.7207](#) [4301.7208](#) [4301.7209](#) [4301.7301](#) [4301.7005](#) [4301.7003](#) [4301.7001](#) [4301.7004](#) [4301.7002](#) [4301.52](#)
[4301.524](#) [4301.72](#) [4301.5200](#) [4301.7200](#) [4301.5240](#) [4301.8051](#) [4301.8052](#) [4301.8053](#) [4301.8054](#) [4301.8055](#)
[4301.8056](#) [4301.8057](#) [4301.8058](#) [4301.8059](#) [4301.8050](#)