

DRAWING NUMBER: 1108673
 REVISION: G

CABLE CUTTING
 CABLE SOURCE :
 1. TA TUN(DONG GUAN).

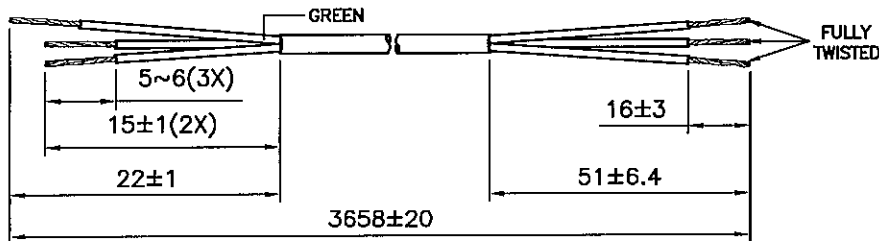

ASSEMBLY :

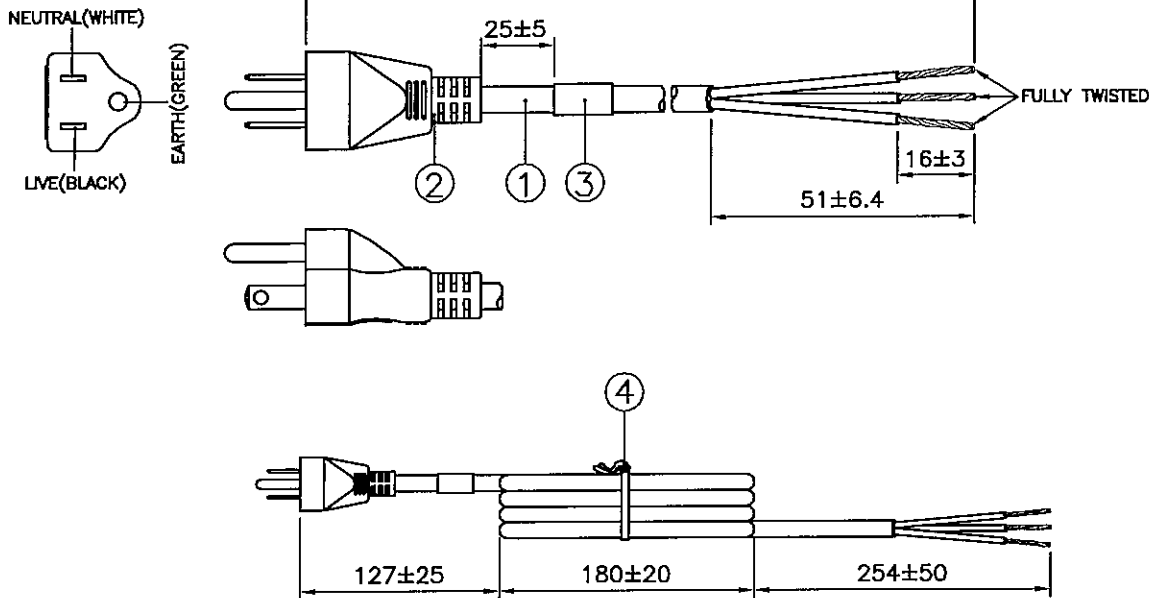

Notes :

1. ALL DIMENSIONS IN mm.
2. PLUG MARKING : REFER TO MARKING DRAWING NO. : VP-0108R.
3. PLUG DETAILS : REFER TO PRODUCT DRAWING NO. : P-0044.
4. LABEL DETAILS : REFER TO LABEL DRAWING NO. : VL-0234.
5. THIS PART CAN BE MANUFACTURED AT ANY LOCATION WHICH HAS SAFETY APPROVAL.

REV.	ECR REF. NO.	DESCRIPTION	DATE
F	130227	CHANGE HANKING DIM. FM. '152±25' TO '180±20'.	20/03/13
G	150232	CHANGE PLUG MARKING DWG. NO. FM. 'VP-0108' TO 'VP-0108R'.	15/05/15

4	12" PE TIE BLK	6310065	1
3	PRINTED LABEL	VL-0234	1
2	IP40G NL792B BLK	4100017	-
2	MOLDED PLUG PS204 (10A 125V)	PS204-R	1
1	SJO 18/3 90 BWG BLK (16/0.254/COTTON FILLER)	1921006	3.658M

S/N	DESCRIPTION	ITEM NUMBER	QTY
-----	-------------	-------------	-----

TITLE : NORTH-AMERICAN POWER SUPPLY CORD (CS-LF0001) PAGE : 1/2

CUSTOMER : VNA/VOLEX INC HG12-055-07

CUSTOMER PART NUMBER : 17412 1Ø B1 DWG. TYPE

F/G CODE : 17412 1Ø B1 SPEC NO.: --- OED

SALES : N.A.	QA : N.A.	ENGRG : Feng	CHECKED BY : Sandy	DRAWN BY : SANDY YU	Volex (Asia) Pte Ltd <small>Confidential property of Volex. Information contained herein shall not be disclosed to others, reproduced or used for any other purposes except as authorized in writing by an authorized official of Volex Asia.</small>
DATE : N.A.	DATE : N.A.	DATE : 23/05/15	DATE : 18/05/15	DATE : 15/05/15	

DRAWING NUMBER :

1108673

PACKAGING INSTRUCTION

1. ALL CORDS LAYOUT AS DETAIL.
3. PACKAGING : 25 PCS PER CARTON.

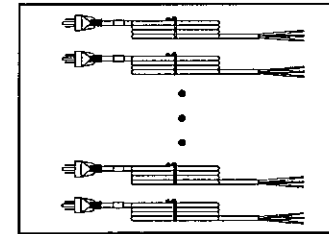
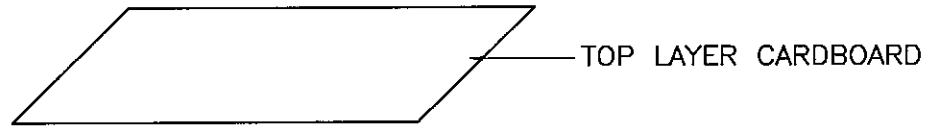

DETAIL A

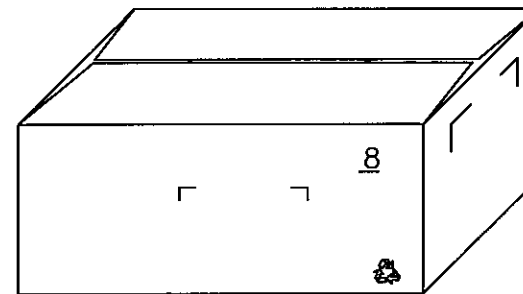
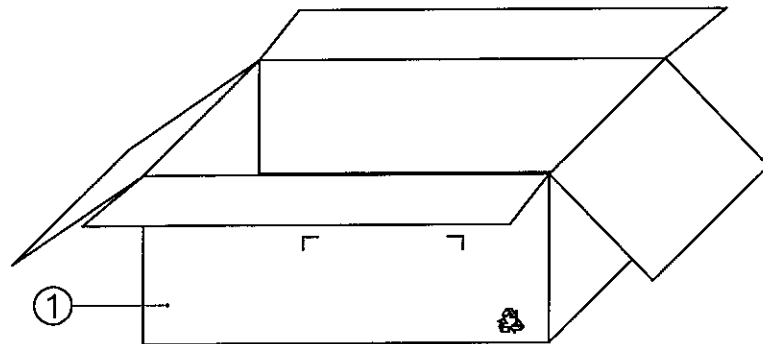
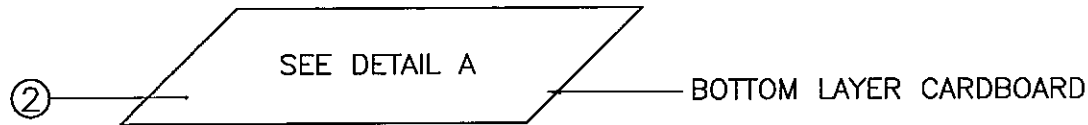

NOTE :

1.) ALL DIMENSIONS IN mm.

2	CARTON LAYER PAD 420X350MM	901022	0.08
1	CA C/BOX 43X36X18CM	901014	0.04
S/N	DESCRIPTION	ITEM NUMBER	QTY

REVISION	G	TITLE : PACKAGING SPEC.
PAGE	2/2	
SCALE	N.T.S.	

REFERENCE :	DESCRIPTION : CARTON BOX	<i>Volex (Asia) Pte Ltd</i>
		<small>Confidential property of Volex. Information contained herein shall not be disclosed to others, reproduced or used for any other purposes except as authorized in writing by an authorized official of Volex Asia.</small>

Mouser Electronics

Authorized Distributor

Click to View Pricing, Inventory, Delivery & Lifecycle Information:

[Volex:](#)

[17412 10 B1](#)