

Guided drives DFM/DFM-B

FESTO



Festo core product range
Covers 80% of your automation tasks

Worldwide:

Always in stock

Superb:

Festo quality at an attractive price

Easy:

Reduces procurement and storing complexity

★ Ready for dispatch from the Festo factory in 24 hours
Held in stock in 13 service centres worldwide
More than 2200 products

★ Ready for dispatch in 5 days maximum from stock
Assembled for you in 4 service centres worldwide
Up to 6 x 10¹² variants per product series

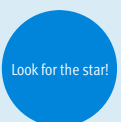

Guided drives DFM/DFM-B

Key features

FESTO

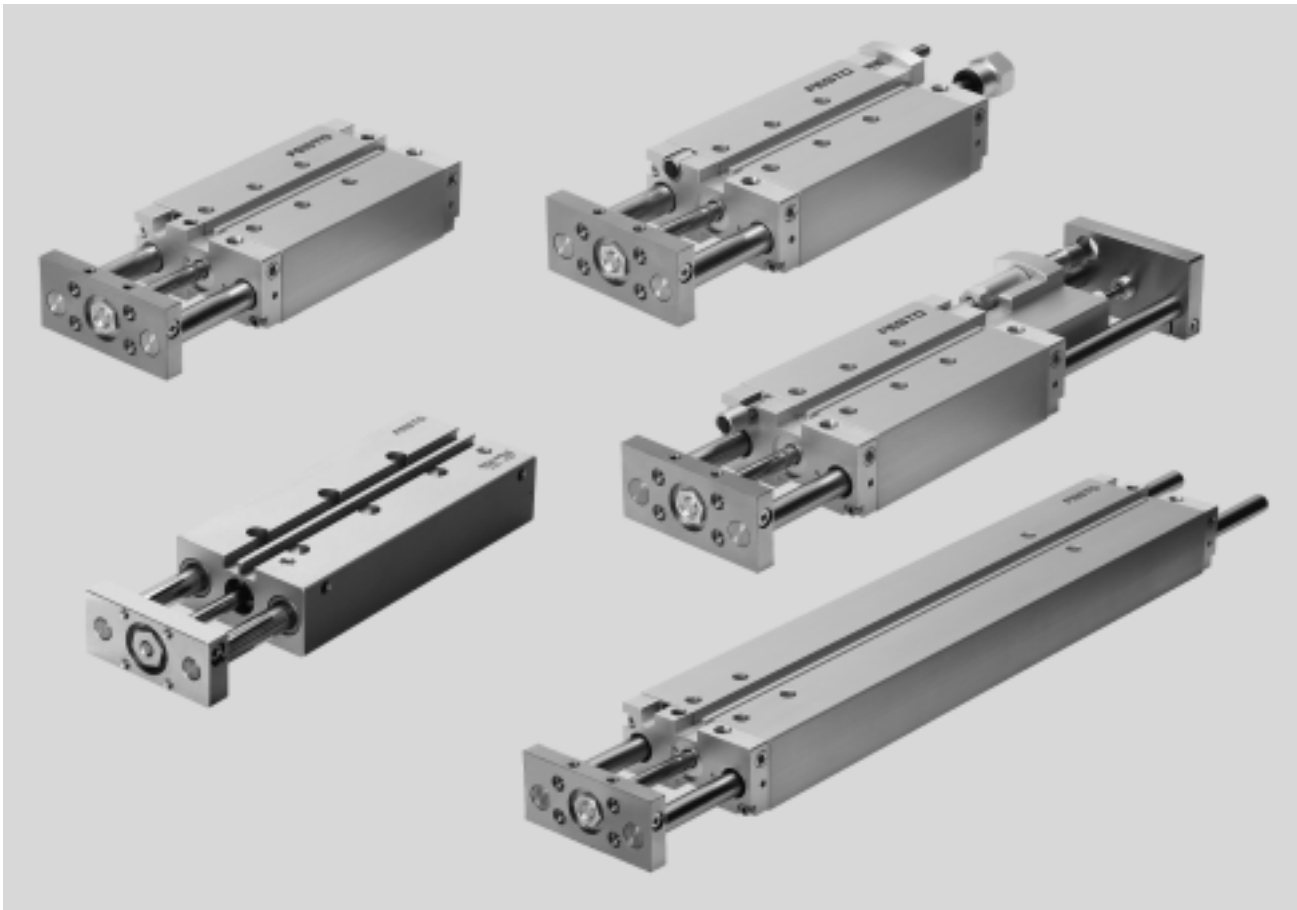

Drive and guide unit in a single housing

- Minimal space requirement
- Minimal assembly time
- Choice of supply ports
- Versatile mounting options

Sturdy and accurate

- Good protection against torsion
- Rigid construction
- Maintenance-free

High resistance to torques and lateral forces

- With plain-bearing guide:
It offers high rigidity thanks to its large-diameter guide rods and four plain-bearing bushes
- With recirculating ball bearing guide:
For applications involving torque loads

Wide choice of variants

- With adjustable end position
- With shock absorber
- Long-stroke version
- With pneumatic end-position cushioning PPV

Guided drives DFM/DFM-B

Key features

Use in conveyor systems

Lifting

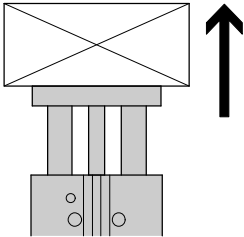

Pushing

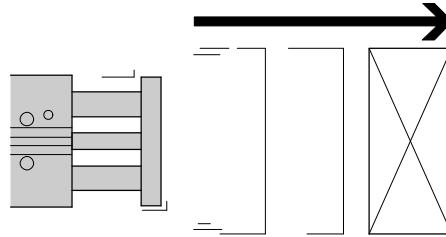

Stopping

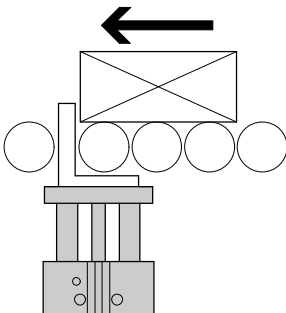

Stopping via stop bracket

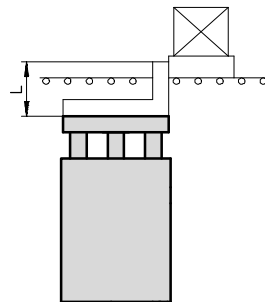

It is recommended to fit a buffer on the workpiece carrier.

Mounting options

Flat from above

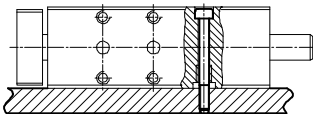

Flat from below

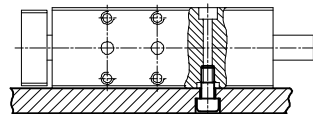

Side mounting from below

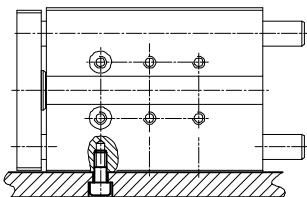

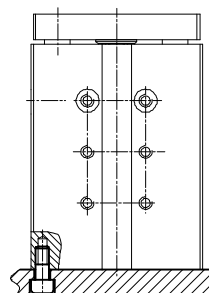

On end

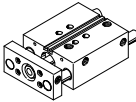
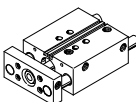
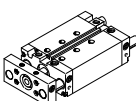
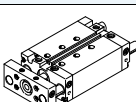

Guided drives DFM/DFM-B

Product range overview

Function	Version	Type	Piston Ø	Stroke	Variable stroke
			[mm]	[mm]	[mm]
Double-acting	DFM basic version with recirculating ball bearing guide				
		DFM Piston rod at one end	12, 16	10, 20, 25, 30, 40, 50, 80, 100	–
			20, 25	20, 25, 30, 40, 50, 80, 100	–
			32	20, 25, 30, 40, 50, 80, 100, 125, 160, 200	–
			40, 50, 63, 80, 100	25, 50, 80, 100, 125, 160, 200	–
	DFM basic version with plain-bearing guide				
		DFM Piston rod at one end	12, 16	10, 20, 25, 30, 40, 50, 80, 100	–
			20, 25	20, 25, 30, 40, 50, 80, 100	–
			32	20, 25, 30, 40, 50, 80, 100, 125, 160, 200	–
			40, 50, 63, 80, 100	25, 50, 80, 100, 125, 160, 200	–
	DFM-B with recirculating ball bearing guide				
		DFM-B Piston rod at one end	12, 16	10, 20, 25, 30, 40, 50, 80, 100, 125, 160, 200	10 ... 200
			20, 25, 32	20, 25, 30, 40, 50, 80, 100, 125, 160, 200, 250, 320, 400	20 ... 400
			40, 50, 63	25, 50, 80, 100, 125, 160, 200, 250, 320, 400	25 ... 400
	DFM-B with plain-bearing guide				
		DFM-B Piston rod at one end	12, 16	10, 20, 25, 30, 40, 50, 80, 100, 125, 160, 200	10 ... 200
			20, 25, 32	20, 25, 30, 40, 50, 80, 100, 125, 160, 200, 250, 320, 400	20 ... 400
			40, 50, 63	25, 50, 80, 100, 125, 160, 200, 250, 320, 400	25 ... 400

-  - Note
 GSED
 sizing software
 → www.festo.com

Guided drives DFM/DFM-B

Product range overview

Type	Position sensing	Cushioning			Heat-resistant seals	Precision end-position adjustment		→ Page/Internet
		Not adjustable	Adjustable for heavy loads	Self-adjusting end position adjustable for heavy loads		Advanced end position	Retracted end position	
	A	P	PPV	YSRW	S6	AJ	EJ	
DFM basic version with recirculating ball bearing guide								
DFM Piston rod at one end	■	■	-	-	-	-	-	8
DFM basic version with plain-bearing guide								
DFM Piston rod at one end	■	■	-	-	-	-	-	8
DFM-B with recirculating ball bearing guide								
DFM-B Piston rod at one end	■	■	■ Ø 16 and above	■ Ø 20 and above	-	■	■ Ø 20 and above	30
DFM-B with plain-bearing guide								
DFM-B Piston rod at one end	■	■	■	-	■	■	■	30

Guided drives DFM

Peripherals overview

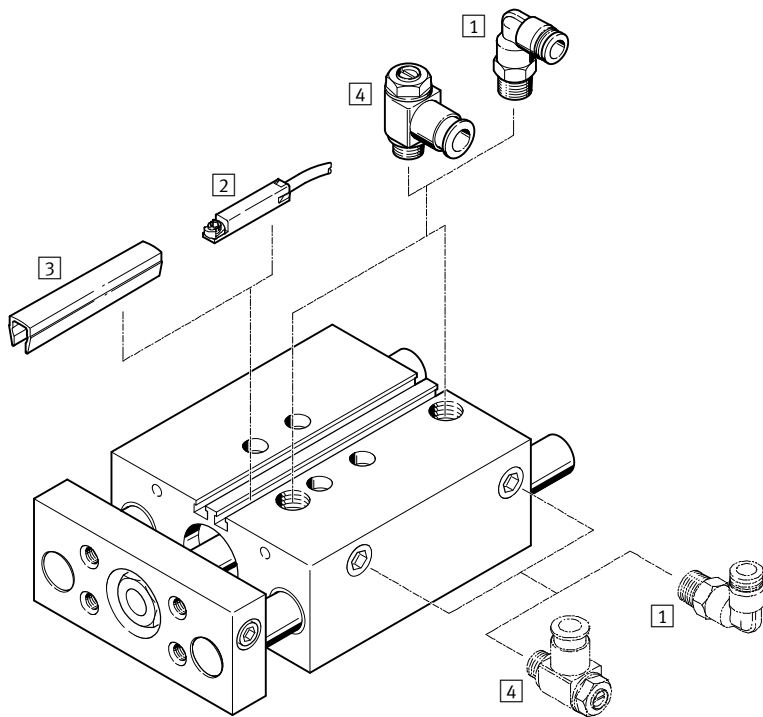

Accessories		
	Description	→ Page/Internet
1	Push-in fitting QS	qs
2	Proximity sensor SME-/SMT-8	60
3	Slot cover ABP-5-S	62
4	One-way flow control valve GRLA	62
-	Centring sleeves ZBH	60
-	Adapters	63
	For drive/drive combinations	
	For drive/gripper combinations	gripper

Guided drives DFM

Type codes

DFM		50	80	P	A	
Type						
Double-acting						
DFM	Guided drive					
Piston Ø [mm]						
Stroke [mm]						
Cushioning						
P	Flexible cushioning rings/plates at both ends					
Position sensing						
A	For proximity sensing					
Guide						
GF	Plain-bearing guide					
KF	Recirculating ball bearing guide					

High functionality

Direction of movement

Excellent protection against torsion, high resistance to torques and lateral forces

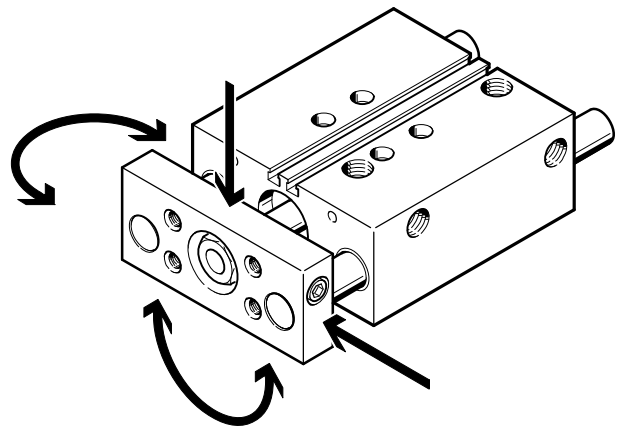
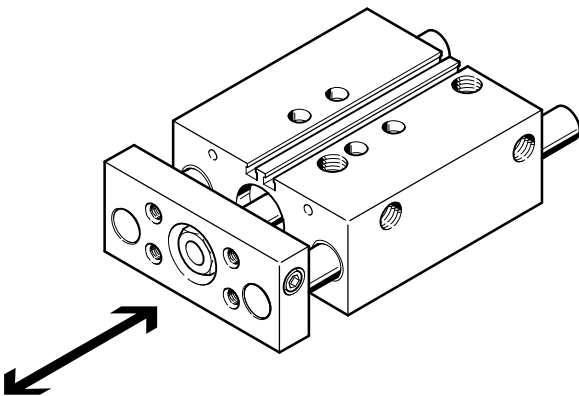

Guided drives DFM

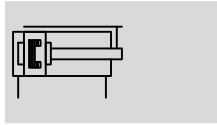

Technical data

Function

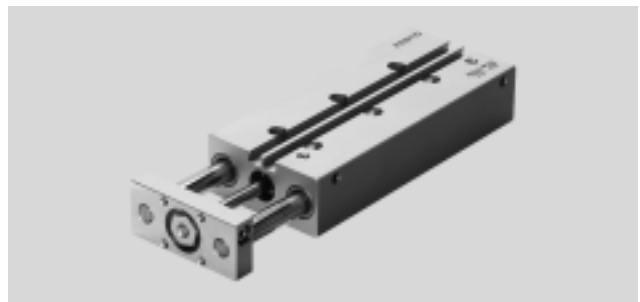

 www.festo.com



-  - Diameter
12 ... 100 mm
-  - Stroke length
10 ... 200 mm

General technical data										
Piston Ø	12	16	20	25	32	40	50	63	80	100
Pneumatic connection	M5	M5	M5	G1/8	G1/8	G1/8	G1/4	G1/4	G3/8	G3/8
Operating medium	Compressed air in accordance with ISO 8573-1:2010 [7:4:4]									
Note on operating/pilot medium	Operation with lubricated medium possible (in which case lubricated operation will always be required)									
Operating pressure [bar]	2 ... 10			1.5 ... 10			1 ... 10		0.5 ... 10	
Design	Piston									
	Piston rod									
	Guide rods with yoke									
Cushioning	Flexible cushioning rings/plates at both ends									
Position sensing	For proximity sensing									
Type of mounting	Via through-holes									
	Via female threads									
Assembly position	Any									
Protection against torsion/guide	Guide rod with yoke/with plain-bearing or ball bearing guide									

-  - Note: This product conforms to ISO 1179-1 and to ISO 228-1

Ambient conditions		
Variant	Plain-bearing guide GF	Recirculating ball bearing guide KF
Ambient temperature ¹⁾ [°C]	-20 ... +80	-5 ... +60
Corrosion resistance class CRC ²⁾	2	-
ATEX	Specified types → www.festo.com	

1) Note operating range of proximity sensors

2) Corrosion resistance class CRC 2 to Festo standard FN 940070

Moderate corrosion stress. Indoor applications in which condensation may occur. External visible parts with primarily decorative requirements for the surface and which are in direct contact with the ambient atmosphere typical for industrial applications.

Speeds [m/s]										
Piston Ø	12	16	20	25	32	40	50	63	80	100
Cushioning P										
Maximum speed, advancing	0.8	0.8	0.8	0.8	0.8	0.8	0.6	0.6	0.4	0.4
Maximum speed, retracting	0.8	0.8	0.8	0.8	0.8	0.8	0.6	0.6	0.4	0.4

Forces [N]										
Piston Ø	12	16	20	25	32	40	50	63	80	100
Theoretical force at 6 bar, advancing	68	121	188	295	482	754	1178	1870	3016	4712
Theoretical force at 6 bar, retracting	51	90	141	247	415	686	1057	1750	2827	4418

Guided drives DFM

Technical data

FESTO

Impact energy [J]										
Piston Ø	12	16	20	25	32	40	50	63	80	100
Max. impact energy at the end positions	0.07	0.15	0.20	0.30	0.40	0.70	1.00	1.30	0.75	1.00

Permissible impact velocity:

$$v_{perm.} = \sqrt{\frac{2 \times E_{perm.}}{m_{dead} + m_{load}}}$$

$v_{perm.}$ Permissible impact velocity
 $E_{perm.}$ Max. impact energy
 m_{dead} Moving load (drive)
 m_{load} Moving work load

 - Note
 These specifications represent the maximum values which can be reached. Note the maximum permitted impact energy.

Maximum permissible load:

$$m_{load} = \frac{2 \times E_{perm.}}{v^2} - m_{dead}$$

DFM with plain-bearing guide GF										
Stroke [mm]	Piston Ø [mm]									
	12	16	20	25	32	40	50	63	80	100
Product weight [g]										
10	338	449	-	-	-	-	-	-	-	-
20	371	515	777	1250	1770	-	-	-	-	-
25	405	540	825	1270	1835	2145	3431	4472	6984	11000
30	435	571	865	1340	1915	-	-	-	-	-
40	494	707	1060	1420	2120	-	-	-	-	-
50	540	770	1150	1630	2230	2520	4092	5213	8185	12589
80	690	920	1350	1990	2795	2980	5016	6273	9743	14699
100	775	1085	1595	2226	3092	3531	5434	6791	10482	15760
125	-	-	-	-	3586	3915	6338	7865	11490	17094
160	-	-	-	-	3630	4520	7219	8920	12910	18980
200	-	-	-	-	4777	5389	8139	10172	14363	21148
Moving load [g]										
10	170	230	-	-	-	-	-	-	-	-
20	190	250	400	650	1040	-	-	-	-	-
25	190	260	420	670	1070	1190	2050	2510	4140	6300
30	200	280	440	690	1090	-	-	-	-	-
40	230	340	550	760	1150	-	-	-	-	-
50	250	370	580	800	1210	1330	2280	2740	4720	7110
80	290	430	680	910	1480	1600	2720	3190	5460	8140
100	320	470	740	990	1590	1720	2910	3370	5730	8520
125	-	-	-	-	1840	1960	3300	3760	6080	9000
160	-	-	-	-	2040	2170	3630	4090	6550	9670
200	-	-	-	-	2280	2400	4000	4460	7100	10430

Guided drives DFM

Technical data

DFM with recirculating ball bearing guide KF										
Stroke [mm]	Piston Ø [mm]									
	12	16	20	25	32	40	50	63	80	100
Product weight [g]										
10	320	424	–	–	–	–	–	–	–	–
20	340	481	732	1185	1583	–	–	–	–	–
25	377	507	760	1215	1639	1953	3135	4155	6506	10520
30	403	535	810	1288	1711	–	–	–	–	–
40	466	647	967	1425	1849	–	–	–	–	–
50	508	704	1050	1534	1993	2342	3704	4880	7582	11980
80	560	878	1290	1871	2425	2867	4489	5791	8895	13612
100	723	988	1330	2089	2726	3166	4930	6337	9500	14587
125	–	–	–	–	3627	3616	5626	7860	10485	15820
160	–	–	–	–	3890	4161	6409	8110	11750	17545
200	–	–	–	–	4189	4798	7550	9300	13214	21124
Moving load [g]										
10	150	200	–	–	–	–	–	–	–	–
20	160	220	360	590	860	–	–	–	–	–
25	160	230	380	600	880	1000	1720	2180	3670	5700
30	170	240	390	620	900	–	–	–	–	–
40	190	290	480	670	960	–	–	–	–	–
50	200	300	500	700	980	1100	1880	2340	4090	6320
80	230	350	570	790	1160	1280	2180	2640	4630	7110
100	250	380	620	850	1240	1360	2310	2770	4840	7410
125	–	–	–	–	1400	1530	2580	3040	5090	7780
160	–	–	–	–	1540	1670	2810	3270	5450	8310
200	–	–	–	–	1710	1830	3070	3530	5860	8910

Materials

Sectional view

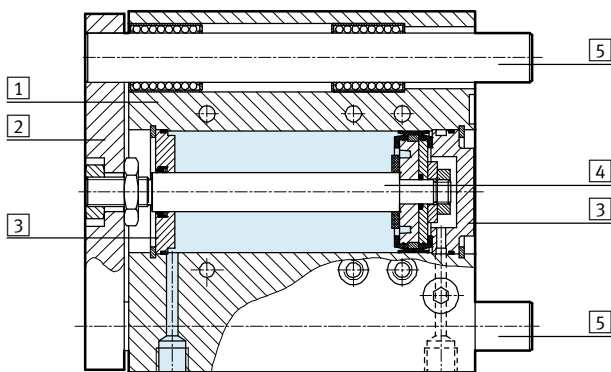

Variant	Plain-bearing guide GF	Recirculating ball bearing guide KF
1 Housing	Wrought aluminium alloy, anodised	Wrought aluminium alloy, anodised
2 Yoke plate	Tempered steel	Tempered steel
3 Bearing and end caps	Wrought aluminium alloy, anodised	Wrought aluminium alloy, anodised
4 Piston rod	High-alloy stainless steel	High-alloy stainless steel
5 Guide rods	High-alloy stainless steel	Tempered steel
– Static seals	Nitrile rubber	Nitrile rubber
– Dynamic seals	Polyurethane	Polyurethane
Note on materials	RoHS compliant	

Guided drives DFM

Technical data

FESTO

Maximum effective load F [N]

Plain-bearing guide GF and recirculating ball bearing guide KF

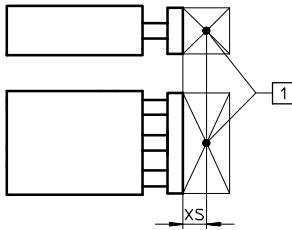

1 Centre of gravity of effective load

Piston Ø [mm]	XS [mm]	Stroke [mm]											
		10	20	25	30	40	50	80	100	125	160	200	
12	GF	25	28	24	23	21	31	28	22	19	-	-	-
	KF		27	23	21	20	23	22	20	19	-	-	-
16	GF	50	63	56	53	51	73	67	55	49	-	-	-
	KF		45	31	27	24	58	56	51	48	-	-	-
20	GF	50	-	67	64	61	110	103	86	77	-	-	-
	KF		-	45	39	35	91	88	80	75	-	-	-
25	GF	50	-	121	116	112	123	115	96	86	-	-	-
	KF		-	88	86	84	100	97	89	85	-	-	-
32	GF	50	-	188	180	173	161	150	166	150	168	146	127
	KF		-	120	118	116	112	109	134	128	144	135	126
40	GF	50	-	-	180	-	-	150	166	150	168	146	127
	KF		-	-	118	-	-	109	134	128	144	135	126
50	GF	50	-	-	257	-	-	216	234	212	229	200	174
	KF		-	-	182	-	-	168	201	193	211	199	188
63	GF	50	-	-	257	-	-	216	234	212	229	200	174
	KF		-	-	182	-	-	168	201	193	211	199	188
80	GF	125	-	-	276	-	-	311	352	329	304	274	245
	KF		-	-	220	-	-	275	329	318	306	291	277
100	GF	125	-	-	452	-	-	509	568	533	494	446	400
	KF		-	-	332	-	-	415	495	480	463	442	422

Permissible torque load M [Nm]

Plain-bearing guide GF and recirculating ball bearing guide KF

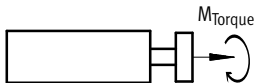

Piston Ø [mm]		Stroke [mm]										
		10	20	25	30	40	50	80	100	125	160	200
12	GF	0.60	0.50	0.48	0.45	0.65	0.60	0.45	0.40	-	-	-
	KF	0.55	0.47	0.44	0.42	0.47	0.45	0.41	0.38	-	-	-
16	GF	1.44	1.30	1.23	1.18	1.68	1.56	1.28	1.14	-	-	-
	KF	1.03	0.71	0.62	0.55	1.34	1.29	1.18	1.12	-	-	-
20	GF	-	1.85	1.75	1.70	3.00	2.80	2.35	2.10	-	-	-
	KF	-	1.30	1.13	1.01	2.64	2.56	2.34	2.23	-	-	-
25	GF	-	4.15	3.95	3.80	4.20	3.90	3.25	2.90	-	-	-
	KF	-	3.00	2.92	2.85	3.40	3.30	3.02	2.89	-	-	-
32	GF	-	7.30	7.00	6.70	6.20	5.80	6.40	5.80	6.50	5.70	5.00
	KF	-	4.70	4.60	4.55	4.40	4.25	5.25	5.00	5.60	5.25	4.90
40	GF	-	-	7.90	-	-	6.55	7.25	6.55	7.35	6.40	5.55
	KF	-	-	5.20	-	-	4.80	5.90	5.65	6.35	5.95	5.55
50	GF	-	-	14.15	-	-	11.85	12.85	11.65	12.55	11.00	9.60
	KF	-	-	10.00	-	-	9.30	11.00	10.60	11.60	11.00	10.30
63	GF	-	-	15.90	-	-	13.30	14.45	13.10	14.10	12.30	10.70
	KF	-	-	11.30	-	-	10.50	12.50	12.00	13.20	12.40	11.70
80	GF	-	-	21.40	-	-	24.20	27.20	25.50	23.50	21.30	19.00
	KF	-	-	17.10	-	-	21.30	25.50	24.70	23.70	22.60	21.50
100	GF	-	-	42.40	-	-	47.80	53.40	50.10	46.40	42.00	37.60
	KF	-	-	25.70	-	-	32.20	38.40	37.20	35.90	34.20	32.70

- Note
GSED
sizing software
→ www.festo.com

Guided drives DFM

Technical data



Torsional backlash p

Plain-bearing guide GF and recirculating ball bearing guide KF in retracted state, without load

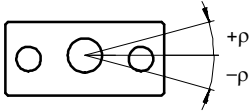

Piston \varnothing		12	16	20	25	32	40	50	63	80	100
Torsional backlash [°]	GF	0.09	0.09	0.07	0.07	0.06	0.06	0.05	0.05	0.03	0.03
	KF	0.08	0.08	0.07	0.07	0.05	0.05	0.05	0.05	0.03	0.03

Deflection of piston rod

Bearing backlash plain-bearing guide GF and recirculating ball bearing guide KF (without load)

DFM-12 ... 20 stroke \leq 30 mm

DFM-12 ... 20 stroke $>$ 30 mm

DFM-25 ... 100:

1 bearing per guide rod

2 bearings per guide rod

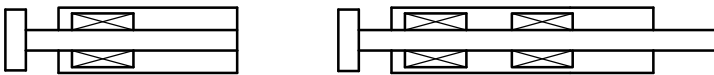

Piston \varnothing		12	16	20	25	32	40	50	63	80	100
Bearing backlash [mm]	GF	0.11	0.11	0.11	0.10	0.13	0.13	0.12	0.12	0.12	0.12
	KF	0.10	0.08	0.08	0.08	0.08	0.08	0.08	0.08	0.07	0.07

Mean deflection f_1 due to bearing backlash as a function of the stroke l

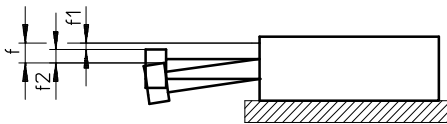

$$f = f_1 + f_2$$

f = Total deflection of piston rod

f_1 = Deflection due to bearing backlash

f_2 = Deflection due to lateral force

DFM with 2 bearings per guide rod

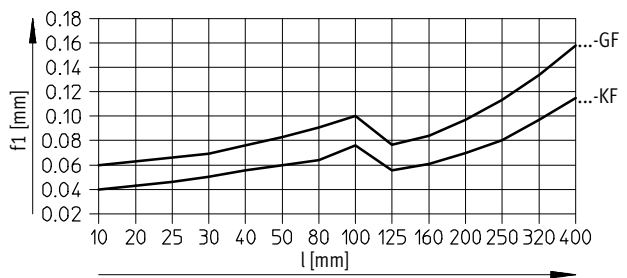

Guided drives DFM

Technical data

Use as a stopper cylinder

When used as a stopper cylinder, only guided drives with plain-bearing guide DFM-...-GF may be used.

In addition, the distance l_{max} . (→ drawing) must not be exceeded.

The permissible kinetic impact energy at the end stop must also not be exceeded.

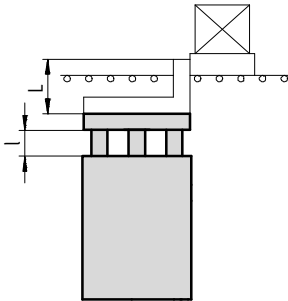

$$l_{max.} = \text{Stroke } l + \text{height of stop bracket } L$$

$$l_{max.} = 50 \text{ mm}$$

Impact mass m as a function of the impact velocity v

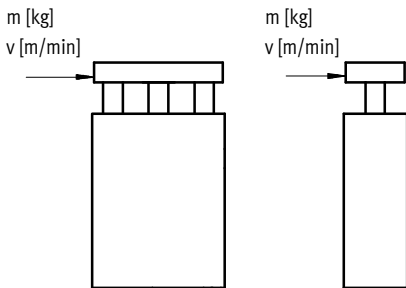

DFM-12 ... 25-GF
Stroke < 30 mm

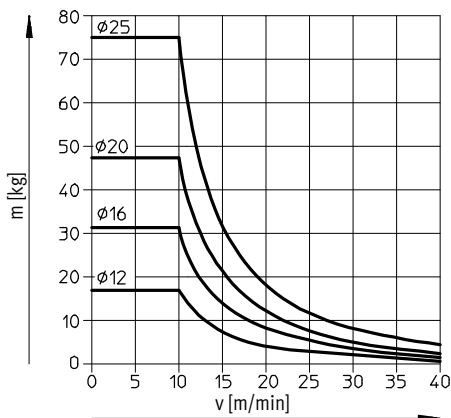

The values in the above graph are based on the assumption that the workpiece carrier is fitted with a flexible buffer with a deformation of 1 mm. Only guided drives with plain-bearing guide GF and a stroke of < 30 mm may be used.

DFM-32 ... 100-GF
Stroke < 50 mm

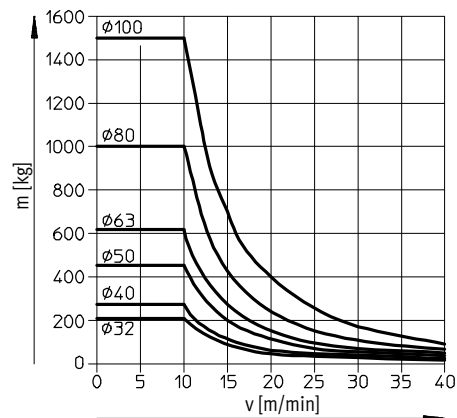

The values in the above graph are based on the assumption that the workpiece carrier is fitted with a flexible buffer with a deformation of 2 mm. Only guided drives with plain-bearing guide GF and a stroke of < 50 mm may be used.

Guided drives DFM

Technical data

Used as lifting cylinder

Permissible load with plain-bearing guide GF

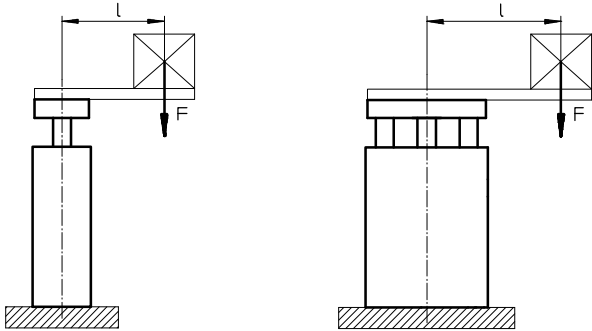

F = Longitudinal force [N]
l = Lever arm [mm]

DFM-12 ... 25-GF
Stroke 30 mm

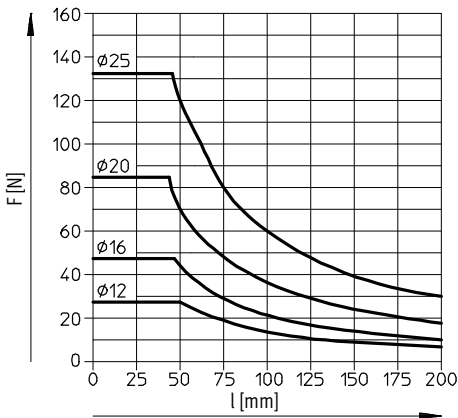

DFM-12 ... 25-GF
Stroke 40 ... 100 mm

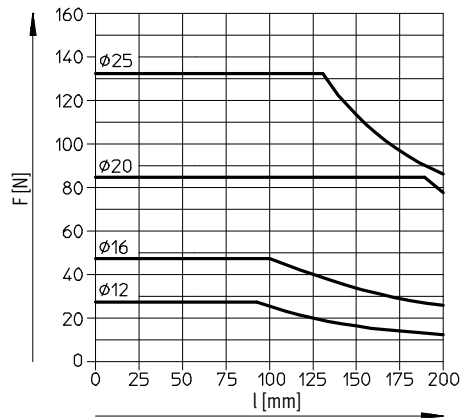

DFM-32 ... 63-GF
Stroke 50 mm

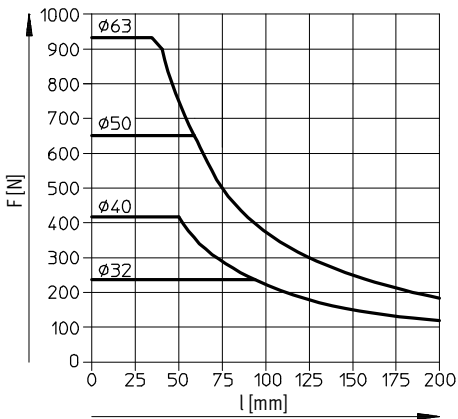

DFM-32 ... 63-GF
Stroke 80 ... 100 mm

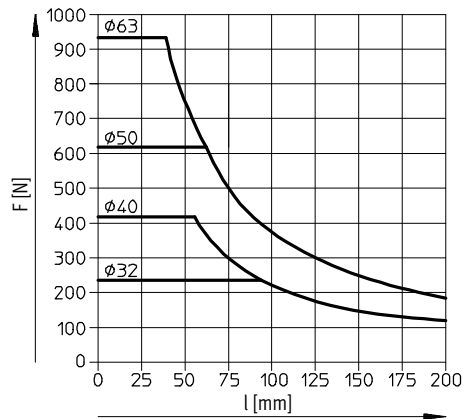

Guided drives DFM

Technical data

Used as lifting cylinder

Permissible load with plain-bearing guide GF

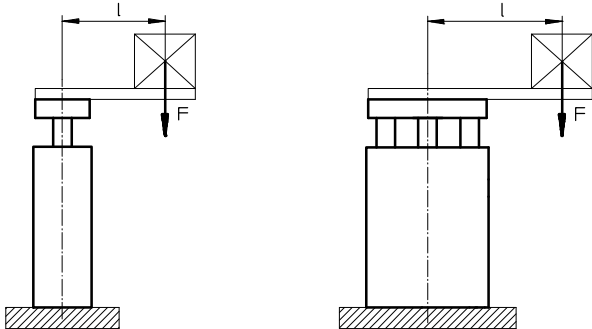

F = Longitudinal force [N]
l = Lever arm [mm]

DFM-32 ... 63-GF
Stroke 125 ... 200 mm

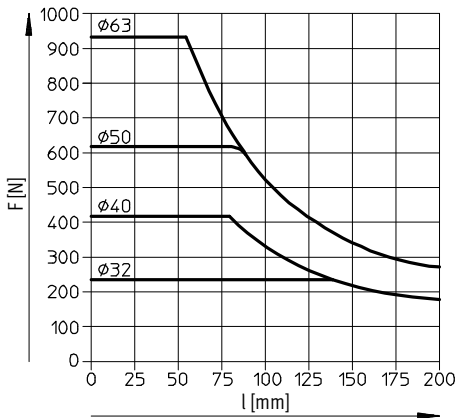

DFM-80 ... 100-GF
Stroke 25 mm

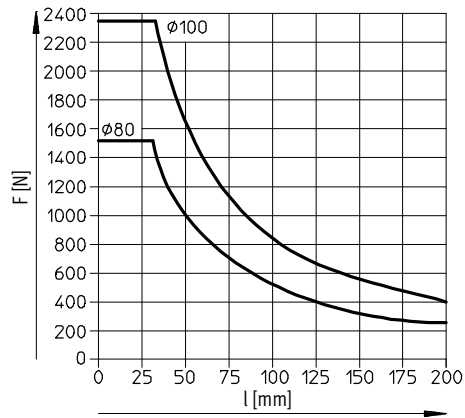

DFM-80 ... 100-GF
Stroke 50 mm

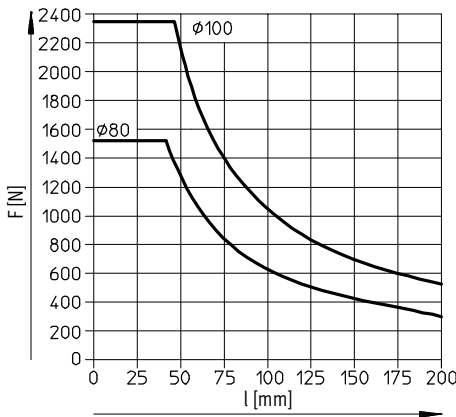

DFM-80 ... 100-GF
Stroke 80 ... 200 mm

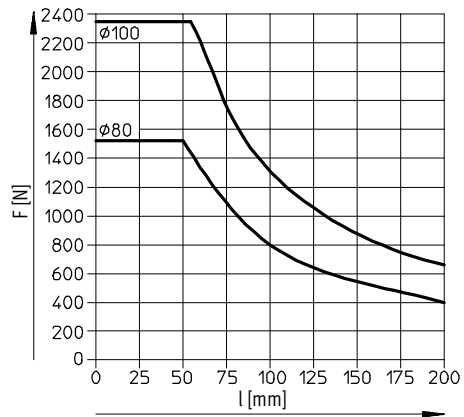

Guided drives DFM

Technical data

Used as lifting cylinder

Permissible load with recirculating ball bearing guide KF

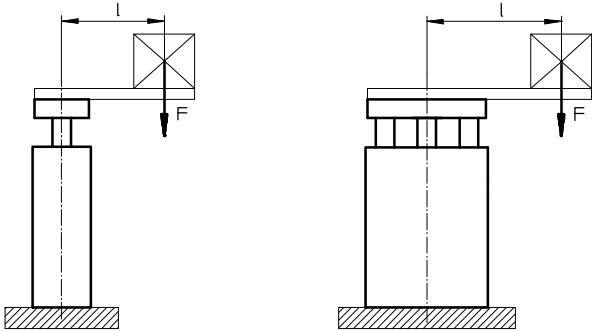

F = Longitudinal force [N]
l = Lever arm [mm]

DFM-12 ... 25-KF
Stroke 30 mm

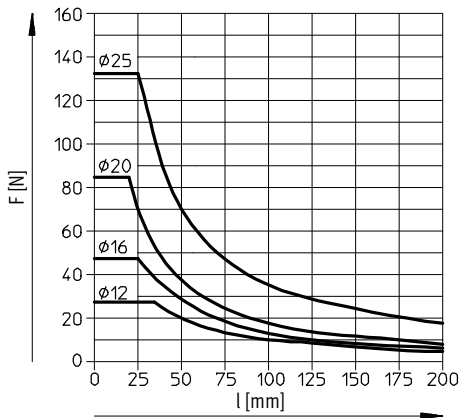

DFM-12 ... 25-KF
Stroke 40 ... 100 mm

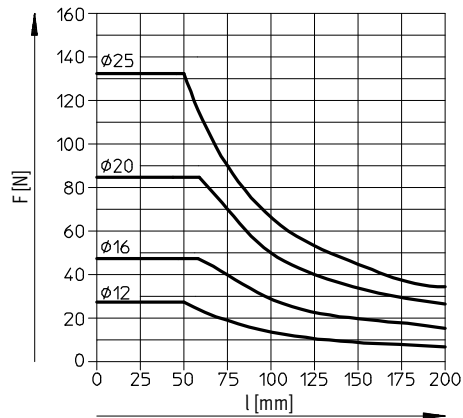

DFM-32 ... 63-KF
Stroke 50 mm

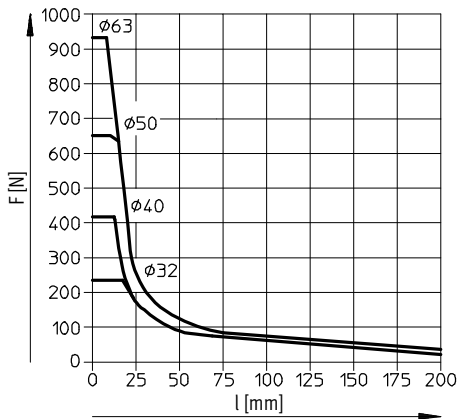

DFM-32 ... 63-KF
Stroke 80 ... 100 mm

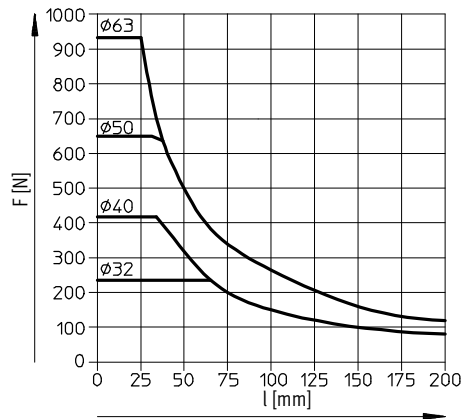

Guided drives DFM

Technical data

Used as lifting cylinder

Permissible load with recirculating ball bearing guide KF

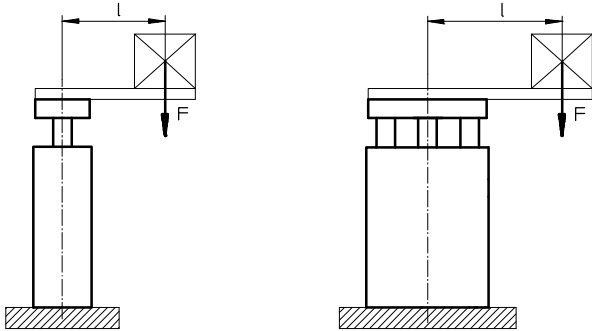

F = Longitudinal force [N]
l = Lever arm [mm]

DFM-32 ... 63-KF
Stroke 125 ... 200 mm

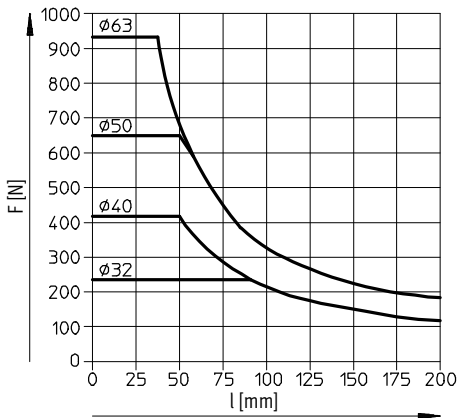

DFM-80 ... 100-KF
Stroke 25 mm

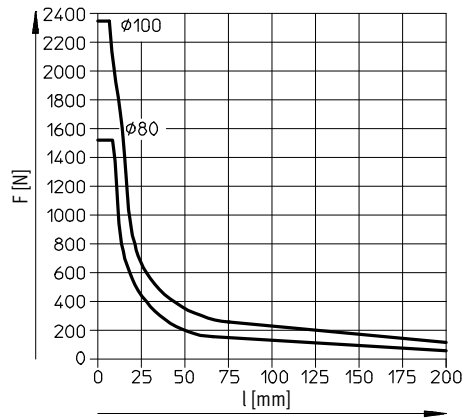

DFM-80 ... 100-KF
Stroke 50 mm

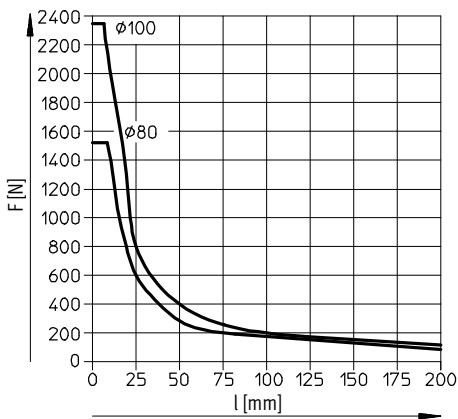

DFM-80 ... 100-KF
Stroke 80 ... 200 mm

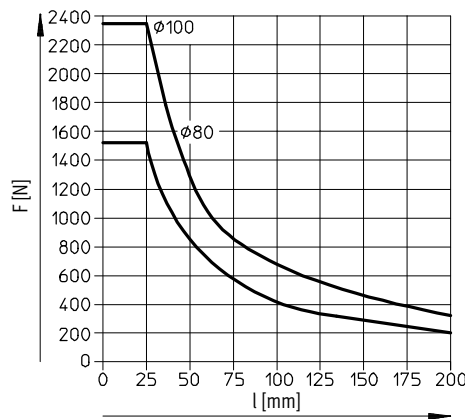

Guided drives DFM

Technical data

FESTO

Dimensions

Piston \varnothing 12 ... 16 mm

Download CAD data → www.festo.com

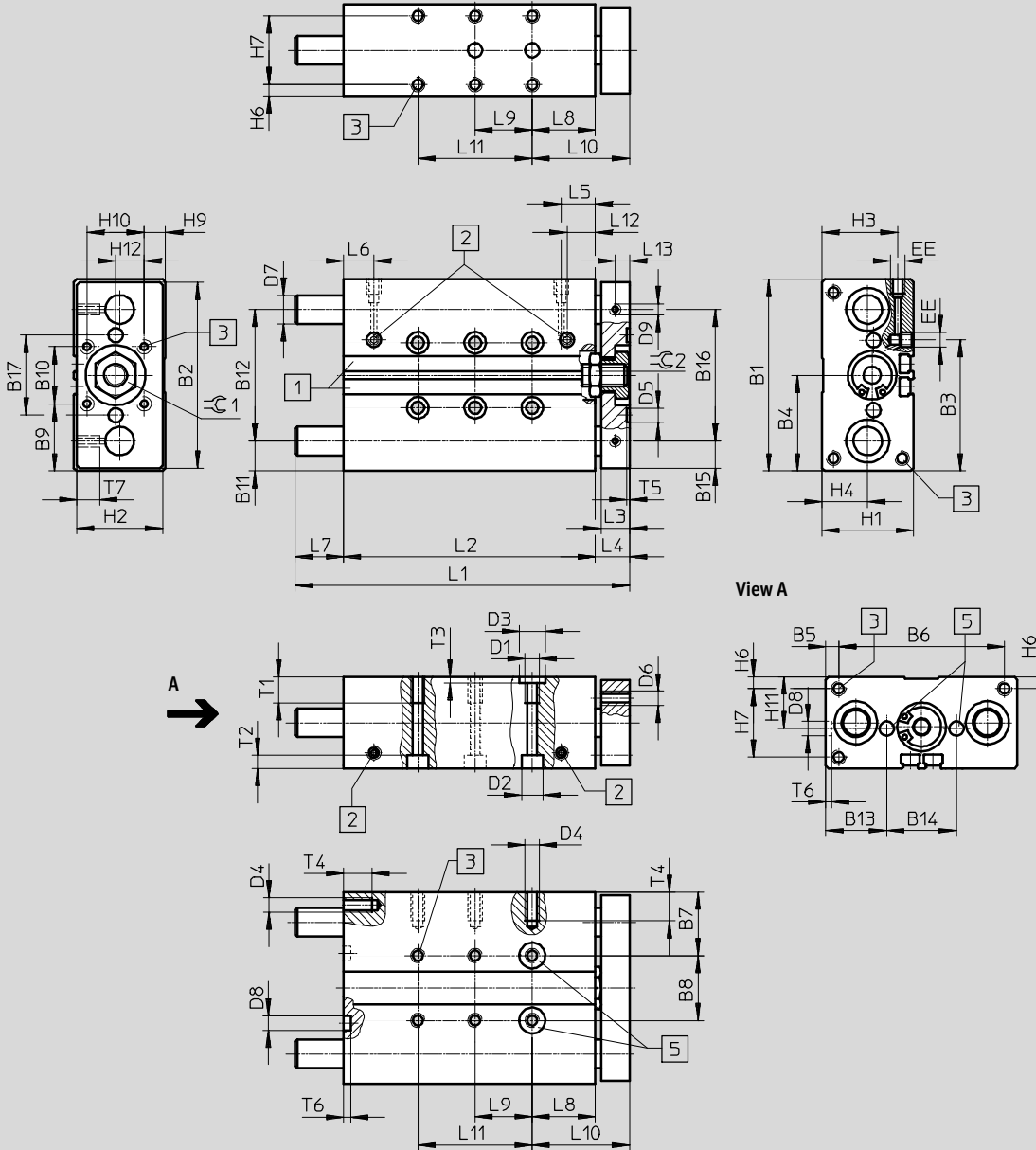

- 1 Mounting slot for proximity sensor SME-/SMT-8
- 2 Supply port optionally at side or top
- 3 Mounting thread
- 5 Tolerance between centring holes ± 0.02 mm

-  - Note

If the guide rods project beyond the housing when the unit is in its retracted end position (→ dimension L7), a recess must be provided in the

mounting surface if the unit is to be mounted against a surface in order to allow the guide rods to move freely.

Guided drives DFM

Technical data



∅ [mm]	B1	B2	B3	B4	B5	B6	B7	B8	B9	B10	B11	B12	B13	B14	B15	B16	B17	D1	D2 ∅	D3 ∅ H7
12	60	58	42.4	30	4.5	51	20.5	19	20	20	9.5	41	19.5	21	8.5	41	25	M5	8	9
16	67	65	45.9	33.5	4.5	58	22	23	23.5	20	10.5	46	21.3	24.4	-	-	28	M5	7.5	9

∅ [mm]	D4	D5 ∅ H7	D6	D7 ∅		D8 ∅ H7	D9	EE	H1	H2	H3	H4	H6	H7	H9	H10	H11	H12
				GF	KF													
12	M4	5	M4	10 _{h8}	8 _{h6}	5	M4	M5	28	26	24	14	4	20	4	20	14	10
16	M5	5	M5	12 _{h8}	10 _{h6}	5	-	M5	32	30	26.5	16	4	24	7.4	20	16	10

∅ [mm]	Stroke [mm]	L1	L2	L3	L4	L5	L6	L7	L8	L9	L10	L11
12	10	59	46	10	13	11.4	9.5	-	21	-	34	-
	20	69	56					-		-		
	25	74	61					-		20		
	30	79	66					-		20		
	40	95	76					6		20		
	50	105	86					6		40		
	80	135	116					6		40		
	100	155	136					6		40		
16	10	60	48	10	12	11.9	10.6	-	22	-	34	-
	20	70	58					-		-		
	25	75	63					-		20		
	30	80	68					-		20		
	40	107	78					17		20		
	50	117	88					17		40		
	80	147	118					17		40		
	100	167	138					17		40		

∅ [mm]	Stroke [mm]	L12	L13	T1	T2	T3	T4	T5	T6	T7	≈C1	≈C2
12	10	11.4	5	9	9.4	2.1	8	1.2	1	8	10	10
	20											
	25											
	30											
	40											
	50											
	80											
16	10	11.9	-	9	4.6	2.1	10	1.2	1	-	14	14
	20											
	25											
	30											
	40											
	50											
	80											

Guided drives DFM

Technical data

FESTO

Dimensions

Piston \varnothing 20 ... 25 mm

Download CAD data → www.festo.com

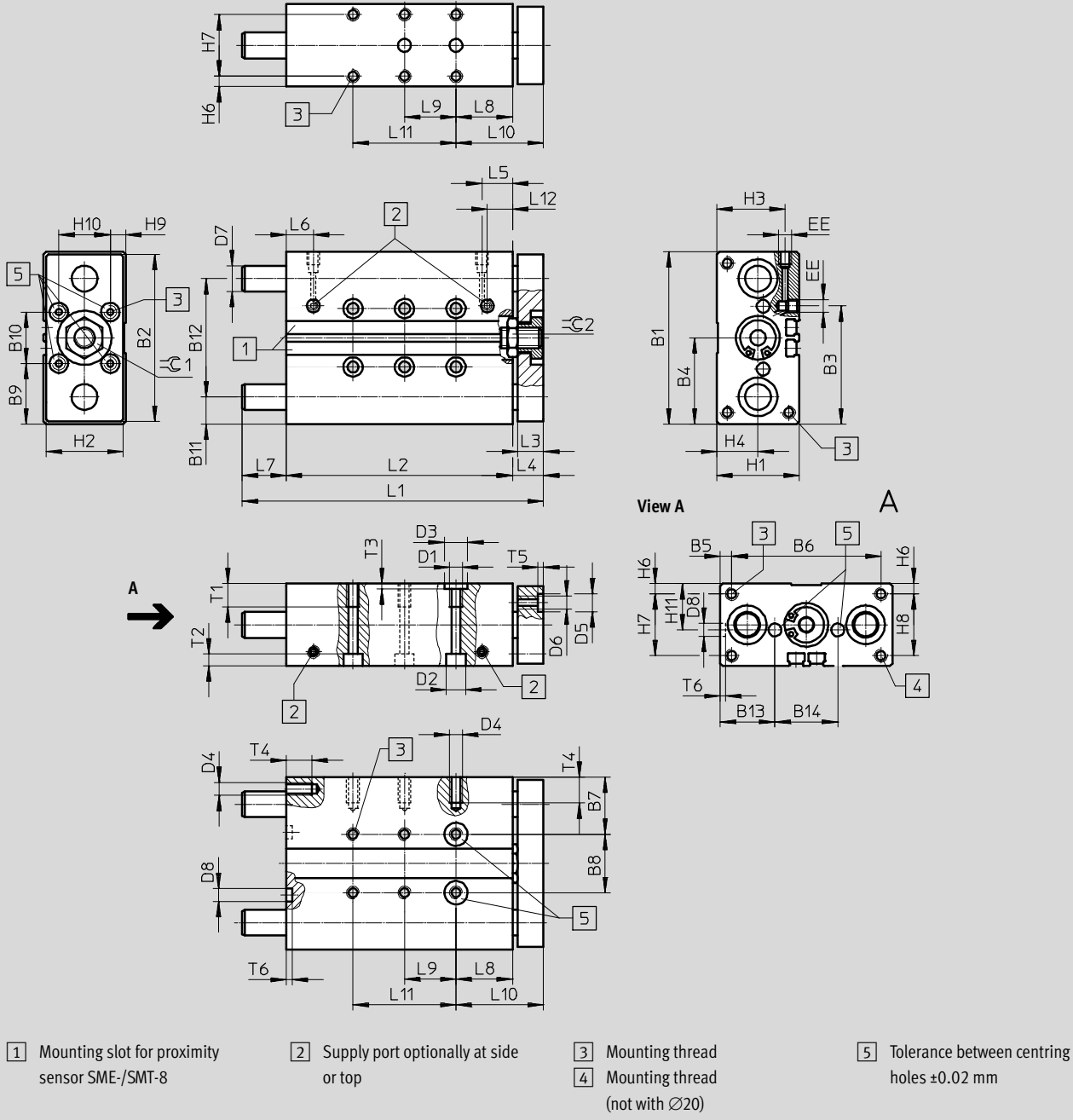

-  - Note

If the guide rods project beyond the housing when the unit is in its retracted end position (→ dimension L7), a recess must be provided in the

mounting surface if the unit is to be mounted against a surface in order to allow the guide rods to move freely.

Guided drives DFM

Technical data



∅ [mm]	B1	B2	B3	B4	B5	B6	B7	B8	B9	B10	B11	B12	B13	B14	D1	D2 ∅	D3 ∅ H7	D4
20	83	81	53.6	41.5	6.5	70	26.5	30	26.5	30	12.5	58	26	31	M6	9	9	M5
25	95	93	70	47.5	15.5	64	30	35	27.5	40	13.5	68	29	37	M6	9	9	M6

∅ [mm]	D5 ∅ H7	D6	D7 ∅		D8 ∅ H7	EE	H1	H2	H3	H4	H6	H7	H8	H9	H10	H11
			GF	KF												
20	9	M5	14h8	12h6	7	M5	36	34	29.5	17	4.5	27	-	7	20	18
25	9	M6	16h8	14h6	7	G1/8	44	42	34.8	19	4.5	35	35	12	20	22

∅ [mm]	Stroke [mm]	L1	L2	L3	L4	L5	L6	L7	L8	L9	L10 ±0.1	L11
	25	80	66	-	20	-						
	30	85	71	-	20	-						
	40	121	81	26	20	-						
	50	131	91	26	40	-						
	80	161	121	26	40	-						
	100	181	141	26	40	80						
25	20	93	65.6	12	14	17.5	9.5	13.4	26	-	40	-
	25	98	70.6					13.4		20		-
	30	103	75.6					13.4		20		-
	40	123	85.6					23.4		20		-
	50	133	95.6					23.4		40		-
	80	163	125.6					23.4		40		-
	100	183	145.6					23.4		40		80

∅ [mm]	Stroke [mm]	L12	T1	T2	T3	T4	T5	T6	∅1	∅2
20	20	14	12	5.7	2.1	10	2.1	1.6	17	17
	25									
	30									
	40									
	50									
	80									
25	20	15	14	5.7	2.1	12	2.1	1.6	17	17
	25									
	30									
	40									
	50									
	80									

-||- Note: This product conforms to ISO 1179-1 and to ISO 228-1

Guided drives DFM

Technical data

FESTO

Dimensions

Piston \varnothing 32 ... 63 mm

Download CAD data → www.festo.com

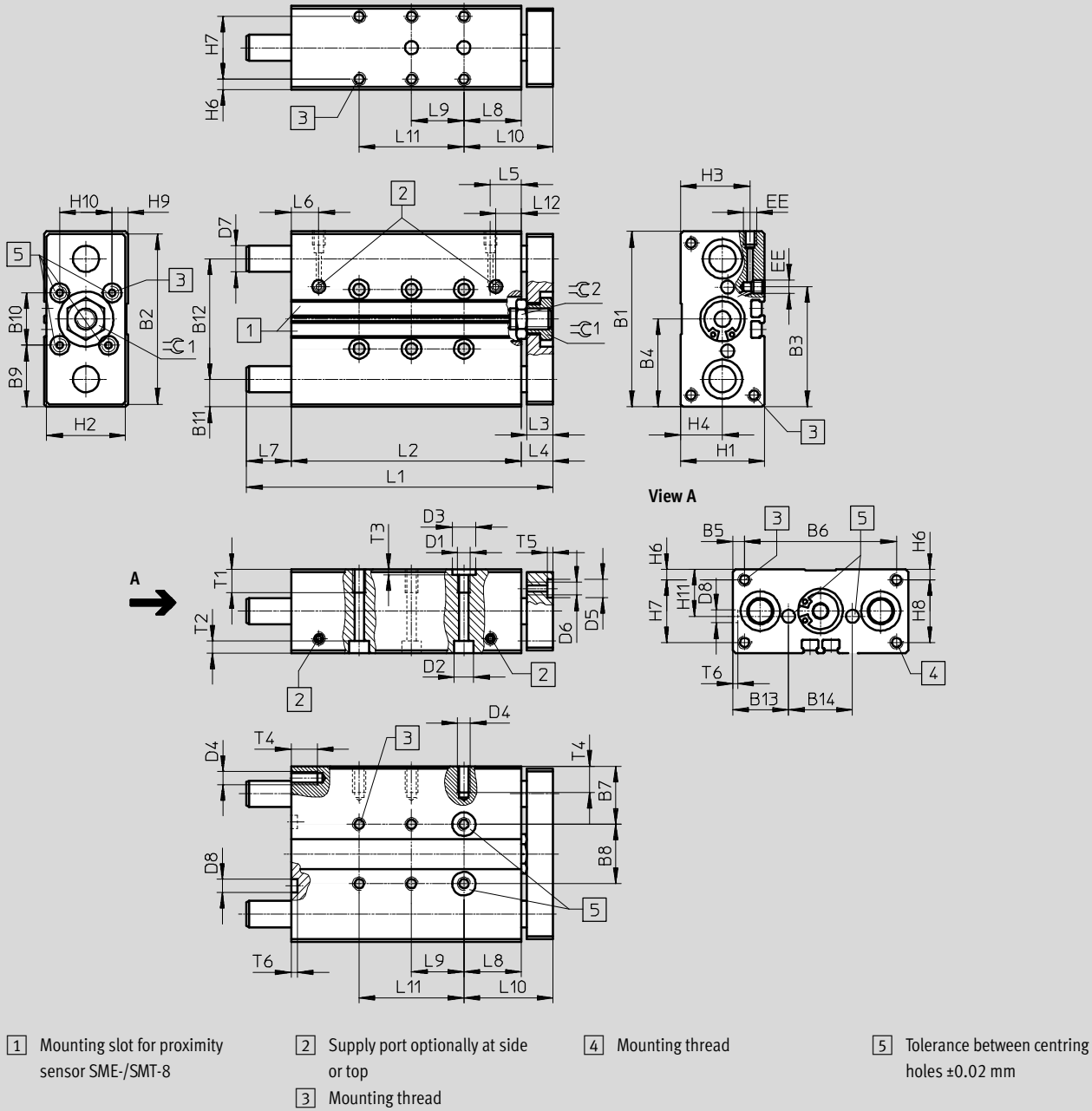

-  - Note

Since the guide rods project beyond the housing when the unit is in its retracted end position (→ dimension L7), a recess must be provided in the

mounting surface if the unit is to be mounted against a surface in order to allow the guide rods to move freely.

Guided drives DFM

Technical data

∅ [mm]	B1	B2	B3	B4	B5	B6	B7	B8	B9	B10	B11	B12	B13	B14	D1	D2 ∅	D3 ∅ H7	D4
32	110	108	81	55	20	70	33.5	43	35	40	16	78	32.5	45	M8	11	12	M6
40	120	118	94	60	15	90	34.5	51	35	50	16	88	32.5	55	M8	11	12	M8
50	148	146	116.5	74	19	110	42	64	44	60	19	110	40	68	M8	11	12	M8
63	162	160	139	81	9	144	41	80	41	80	18.4	125	39.5	83	M10	15	12	M10

∅ [mm]	D5 ∅ H7	D6	D7 ∅		D8 ∅ H7	EE	H1	H2	H3	H4	H5	H6	H7	H8	H9	H10	H11
			GF	KF													
32	9	M6	20h8	16h6	9	G $\frac{1}{8}$	49	47	38.5	22	23.5	6	37	37	8.5	30	24.5
40	9	M6	20h8	16h6	9	G $\frac{1}{8}$	54	52	40.5	24	25	6	42	42	10	30	27
50	12	M8	25h8	20h6	12	G $\frac{1}{4}$	64	62	50.5	29.5	29.7	7	50	50	12	40	32
63	12	M8	25h8	20h6	12	G $\frac{1}{4}$	78	76	55	32	36.8	9	60	60	19	40	39

∅ [mm]	Stroke [mm]	L1	L2	L3	L4	L5	L6	L7	L8	L9	L10 ±0.1	L11	L12	T1	T2	T3	T4	T5	T6	=C1	=C2
25	106	73	17	20	-																
30	111	78	17	20	-																
40	121	88	17	20	-																
50	131	98	17	40	-																
80	179	128	35	40	-																
100	199	148	35	40	80																
125	244	173	55	40	80																
160	279	208	55	40	120																
200	319	248	55	40	160																
40	25	106	76	14	16	17.8	13.1	14	29	20	45	-	17.8	15	6.8	2.6	16	2.1	2.1	17	22
50	131	101	14					40		-											
80	179	131	32					40		-											
100	199	151	32					40		80											
125	244	176	52					40		80											
160	279	211	52					40		120											
200	319	251	52					40		160											
50	25	118	77	16	18	17.8	14.2	23	32	20	50	-	17.8	15	6.8	2.6	16	2.6	2.6	19	24
50	143	102	23					40		-											
80	194	132	44					40		-											
100	214	152	44					40		80											
125	259	177	64					40		80											
160	294	212	64					40		120											
200	334	252	64					40		160											
63	25	118	83	16	18	18.5	14.8	17	32	20	50	-	18.5	20	9	2.6	20	2.6	2.6	19	24
50	143	108	17					40		-											
80	194	138	38					40		80											
100	214	158	38					40		80											
125	259	183	58					40		120											
160	294	218	58					40		160											
200	334	258	58					40		200											

• - Note: This product conforms to ISO 1179-1 and to ISO 228-1

Guided drives DFM

Technical data

FESTO

Dimensions

Piston \varnothing 80 ... 100 mm

Download CAD data → www.festo.com

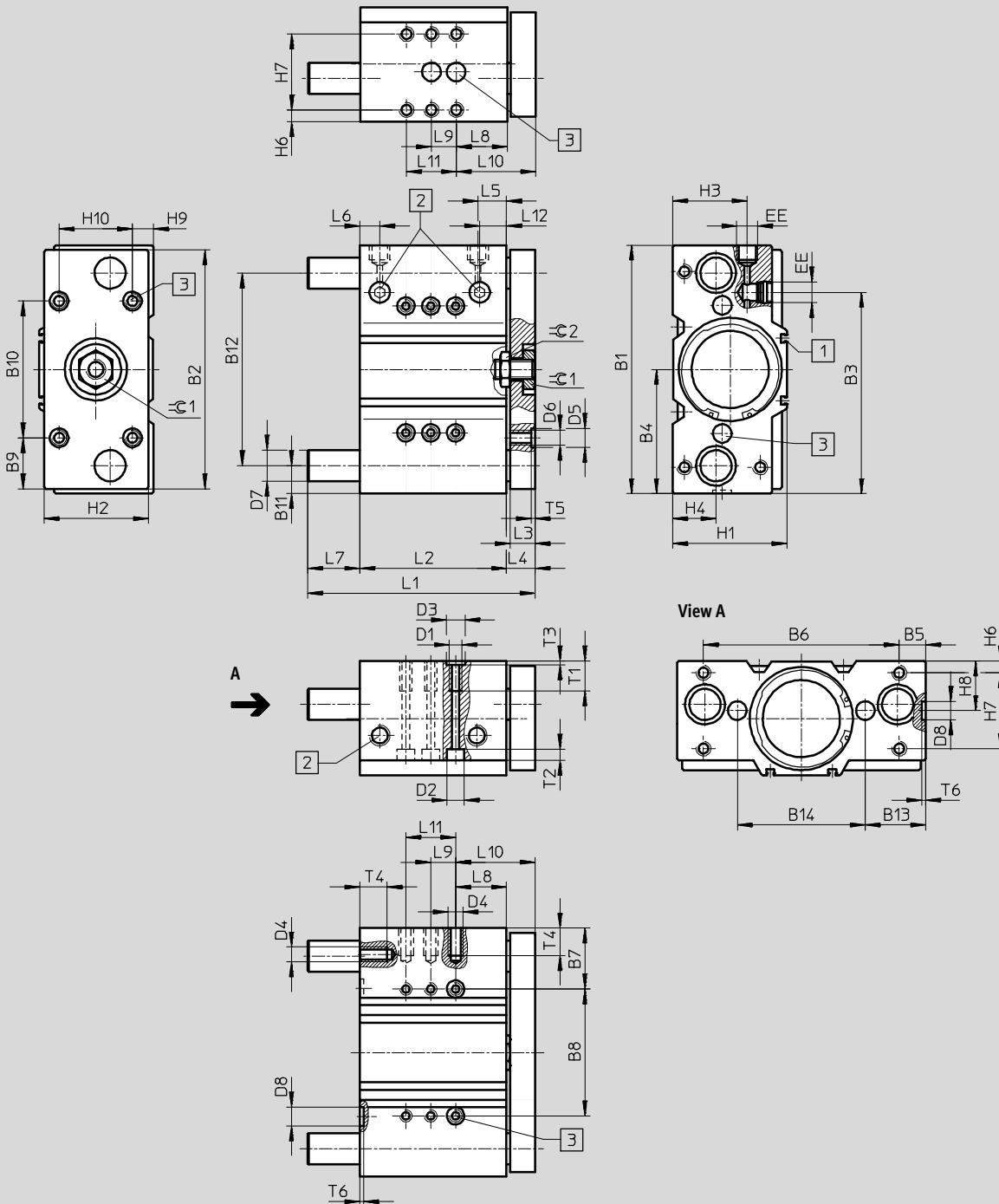

1 Mounting slot for proximity sensor SME-/SMT-8

2 Supply port optionally at side or top

3 Tolerance between centring holes ± 0.02 mm

-  - Note

Since the guide rods project beyond the housing when the unit is in its retracted end position (→ dimension L7), a recess must be provided in the

mounting surface if the unit is to be mounted against a surface in order to allow the guide rods to move freely.

Guided drives DFM

Technical data

∅ [mm]	B1	B2	B3	B4	B5	B6	B7	B8	B9	B10	B11	B12	B13	B14	D1	D2 ∅	D3 ∅ H7
80	200	192	162.5	100	21.5	157	48.5	103	41	110	22.5	155	48.5	103	M10	15	12
100	240	232	201	120	21	198	54	132	56	120	26	188	57	126	M12	18	15

∅ [mm]	D4	D5 ∅ H7	D6	D7 ∅		D8 ∅ H7	EE	H1	H2	H3	H4	H6	H7	H8	H9	H10
				GF	KF											
80	M10	12	M10	30h8	25h6	12	G $\frac{3}{8}$	92	84	61	35	9	62	40	16	60
100	M12	15	M12	35h8	30h6	15	G $\frac{3}{8}$	112	104	66	39.5	10	68	44	16	80

∅ [mm]	Stroke [mm]	L1	L2	L3	L4	L5	L6	L7	L8	L9	L10 ±0.1	L11	L12	T1	T2	T3	T4	T5	T6	≈C1	≈C2
	50	183	118	42	40	-															
	80	243	148	72	40	-															
	100	263	168	72	40	80															
	125	288	193	72	40	80															
	160	323	228	72	40	120															
	200	363	268	72	40	160															
100	25	150	109	20	23	29	20	18	13	40	36	-	29	25	11	3.1	24	3.1	3.1	32	30
	50	197	134					40		40		80									
	80	257	164					70		40		80									
	100	277	184					70		40		120									
	125	302	209					70		40		160									
	160	337	244					70		40		160									
	200	377	284					70		40		200									

• || - Note: This product conforms to ISO 1179-1 and to ISO 228-1

Guided drives DFM

Technical data

FESTO

★ Core product range

Ordering data – Plain-bearing guide GF			
Stroke [mm]	Part No.	Type	
	Piston Ø 12 mm		
10	★ 170824	DFM-12-10-P-A-GF	
20	★ 170825	DFM-12-20-P-A-GF	
25	★ 170826	DFM-12-25-P-A-GF	
30	★ 170827	DFM-12-30-P-A-GF	
40	★ 170828	DFM-12-40-P-A-GF	
50	★ 170829	DFM-12-50-P-A-GF	
80	★ 170830	DFM-12-80-P-A-GF	
100	★ 170831	DFM-12-100-P-A-GF	
	Piston Ø 16 mm		
	★ 170832	DFM-16-10-P-A-GF	
	★ 170833	DFM-16-20-P-A-GF	
	★ 170834	DFM-16-25-P-A-GF	
	★ 170835	DFM-16-30-P-A-GF	
	★ 170836	DFM-16-40-P-A-GF	
	★ 170837	DFM-16-50-P-A-GF	
	★ 170838	DFM-16-80-P-A-GF	
	★ 170839	DFM-16-100-P-A-GF	
	Piston Ø 20 mm		
			–
	★ 170840	DFM-20-20-P-A-GF	
	★ 170841	DFM-20-25-P-A-GF	
	★ 170842	DFM-20-30-P-A-GF	
	★ 170843	DFM-20-40-P-A-GF	
	★ 170844	DFM-20-50-P-A-GF	
	★ 170845	DFM-20-80-P-A-GF	
	★ 170846	DFM-20-100-P-A-GF	
	Piston Ø 25 mm		
20	★ 170847	DFM-25-20-P-A-GF	
25	★ 170848	DFM-25-25-P-A-GF	
30	★ 170849	DFM-25-30-P-A-GF	
40	★ 170850	DFM-25-40-P-A-GF	
50	★ 170851	DFM-25-50-P-A-GF	
80	★ 170852	DFM-25-80-P-A-GF	
100	★ 170853	DFM-25-100-P-A-GF	
125			–
160			
200			
	Piston Ø 32 mm		
	★ 170854	DFM-32-20-P-A-GF	
	★ 170855	DFM-32-25-P-A-GF	
	★ 170856	DFM-32-30-P-A-GF	
	★ 170857	DFM-32-40-P-A-GF	
	★ 170858	DFM-32-50-P-A-GF	
	★ 170859	DFM-32-80-P-A-GF	
	★ 170860	DFM-32-100-P-A-GF	
	★ 170861	DFM-32-125-P-A-GF	
	★ 170862	DFM-32-160-P-A-GF	
	★ 170863	DFM-32-200-P-A-GF	
	Piston Ø 40 mm		
			–
	★ 170864	DFM-40-25-P-A-GF	
			–
	★ 170865	DFM-40-50-P-A-GF	
	★ 170866	DFM-40-80-P-A-GF	
	★ 170867	DFM-40-100-P-A-GF	
	★ 170868	DFM-40-125-P-A-GF	
	★ 170869	DFM-40-160-P-A-GF	
	★ 170870	DFM-40-200-P-A-GF	
	Piston Ø 50 mm		
25	★ 170871	DFM-50-25-P-A-GF	
50	★ 170872	DFM-50-50-P-A-GF	
80	★ 170873	DFM-50-80-P-A-GF	
100	★ 170874	DFM-50-100-P-A-GF	
125	★ 170875	DFM-50-125-P-A-GF	
160	★ 170876	DFM-50-160-P-A-GF	
200	★ 170877	DFM-50-200-P-A-GF	
	Piston Ø 63 mm		
	★ 170878	DFM-63-25-P-A-GF	
	★ 170879	DFM-63-50-P-A-GF	
	★ 170880	DFM-63-80-P-A-GF	
	★ 170881	DFM-63-100-P-A-GF	
	★ 170882	DFM-63-125-P-A-GF	
	★ 170883	DFM-63-160-P-A-GF	
	★ 170884	DFM-63-200-P-A-GF	

Ordering data – Plain-bearing guide GF			
Stroke [mm]	Part No.	Type	
	Piston Ø 80 mm		
25	170885	DFM-80-25-P-A-GF	
50	170886	DFM-80-50-P-A-GF	
80	170887	DFM-80-80-P-A-GF	
100	170888	DFM-80-100-P-A-GF	
125	170889	DFM-80-125-P-A-GF	
160	170890	DFM-80-160-P-A-GF	
200	170891	DFM-80-200-P-A-GF	
	Piston Ø 100 mm		
	170892	DFM-100-25-P-A-GF	
	170893	DFM-100-50-P-A-GF	
	170894	DFM-100-80-P-A-GF	
	170895	DFM-100-100-P-A-GF	
	170896	DFM-100-125-P-A-GF	
	170897	DFM-100-160-P-A-GF	
	170898	DFM-100-200-P-A-GF	

Festo core product range

- ★ Ready for dispatch from the Festo factory in 24 hours
- ☆ Ready for dispatch in 5 days maximum from stock

Guided drives DFM

Technical data

★ Core product range

Ordering data – Recirculating ball bearing guide KF			
Stroke [mm]	Part No.	Type	
Piston Ø 12 mm			
10	★ 170899	DFM-12-10-P-A-KF	
20	★ 170900	DFM-12-20-P-A-KF	
25	★ 170901	DFM-12-25-P-A-KF	
30	★ 170902	DFM-12-30-P-A-KF	
40	★ 170903	DFM-12-40-P-A-KF	
50	★ 170904	DFM-12-50-P-A-KF	
80	★ 170905	DFM-12-80-P-A-KF	
100	★ 170906	DFM-12-100-P-A-KF	
Piston Ø 16 mm			
	★ 170907	DFM-16-10-P-A-KF	
	★ 170908	DFM-16-20-P-A-KF	
	★ 170909	DFM-16-25-P-A-KF	
	★ 170910	DFM-16-30-P-A-KF	
	★ 170911	DFM-16-40-P-A-KF	
	★ 170912	DFM-16-50-P-A-KF	
	★ 170913	DFM-16-80-P-A-KF	
	★ 170914	DFM-16-100-P-A-KF	
Piston Ø 20 mm			
	–		
	★ 170915	DFM-20-20-P-A-KF	
	★ 170916	DFM-20-25-P-A-KF	
	★ 170917	DFM-20-30-P-A-KF	
	★ 170918	DFM-20-40-P-A-KF	
	★ 170919	DFM-20-50-P-A-KF	
	★ 170920	DFM-20-80-P-A-KF	
	★ 170921	DFM-20-100-P-A-KF	
Piston Ø 25 mm			
20	★ 170922	DFM-25-20-P-A-KF	
25	★ 170923	DFM-25-25-P-A-KF	
30	★ 170924	DFM-25-30-P-A-KF	
40	★ 170925	DFM-25-40-P-A-KF	
50	★ 170926	DFM-25-50-P-A-KF	
80	★ 170927	DFM-25-80-P-A-KF	
100	★ 170928	DFM-25-100-P-A-KF	
125	–		
160			
200			
Piston Ø 32 mm			
	★ 170929	DFM-32-20-P-A-KF	
	★ 170930	DFM-32-25-P-A-KF	
	★ 170931	DFM-32-30-P-A-KF	
	★ 170932	DFM-32-40-P-A-KF	
	★ 170933	DFM-32-50-P-A-KF	
	★ 170934	DFM-32-80-P-A-KF	
	★ 170935	DFM-32-100-P-A-KF	
	★ 170936	DFM-32-125-P-A-KF	
	★ 170937	DFM-32-160-P-A-KF	
	★ 170938	DFM-32-200-P-A-KF	
Piston Ø 40 mm			
	–		
	★ 170939	DFM-40-25-P-A-KF	
	–		
	★ 170940	DFM-40-50-P-A-KF	
	★ 170941	DFM-40-80-P-A-KF	
	★ 170942	DFM-40-100-P-A-KF	
	★ 170943	DFM-40-125-P-A-KF	
	★ 170944	DFM-40-160-P-A-KF	
	★ 170945	DFM-40-200-P-A-KF	
Piston Ø 50 mm			
25	★ 170946	DFM-50-25-P-A-KF	
50	★ 170947	DFM-50-50-P-A-KF	
80	★ 170948	DFM-50-80-P-A-KF	
100	★ 170949	DFM-50-100-P-A-KF	
125	★ 170950	DFM-50-125-P-A-KF	
160	★ 170951	DFM-50-160-P-A-KF	
200	★ 170952	DFM-50-200-P-A-KF	
Piston Ø 63 mm			
	★ 170953	DFM-63-25-P-A-KF	
	★ 170954	DFM-63-50-P-A-KF	
	★ 170955	DFM-63-80-P-A-KF	
	★ 170956	DFM-63-100-P-A-KF	
	★ 170957	DFM-63-125-P-A-KF	
	★ 170958	DFM-63-160-P-A-KF	
	★ 170959	DFM-63-200-P-A-KF	
Piston Ø 80 mm			
	–		

Ordering data – Recirculating ball bearing guide KF			
Stroke [mm]	Part No.	Type	
Piston Ø 80 mm			
25	170960	DFM-80-25-P-A-KF	
50	170961	DFM-80-50-P-A-KF	
80	170962	DFM-80-80-P-A-KF	
100	170963	DFM-80-100-P-A-KF	
125	170964	DFM-80-125-P-A-KF	
160	170965	DFM-80-160-P-A-KF	
200	170966	DFM-80-200-P-A-KF	
Piston Ø 100 mm			
	170967	DFM-100-25-P-A-KF	
	170968	DFM-100-50-P-A-KF	
	170969	DFM-100-80-P-A-KF	
	170970	DFM-100-100-P-A-KF	
	170971	DFM-100-125-P-A-KF	
	170972	DFM-100-160-P-A-KF	
	170973	DFM-100-200-P-A-KF	

Festo core product range

- ★ Ready for dispatch from the Festo factory in 24 hours
- ☆ Ready for dispatch in 5 days maximum from stock

Guided drives DFM-B

Peripherals overview

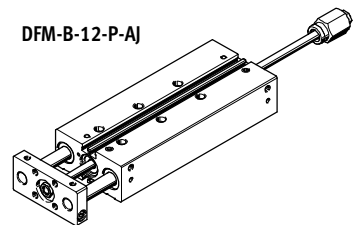
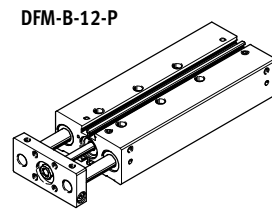
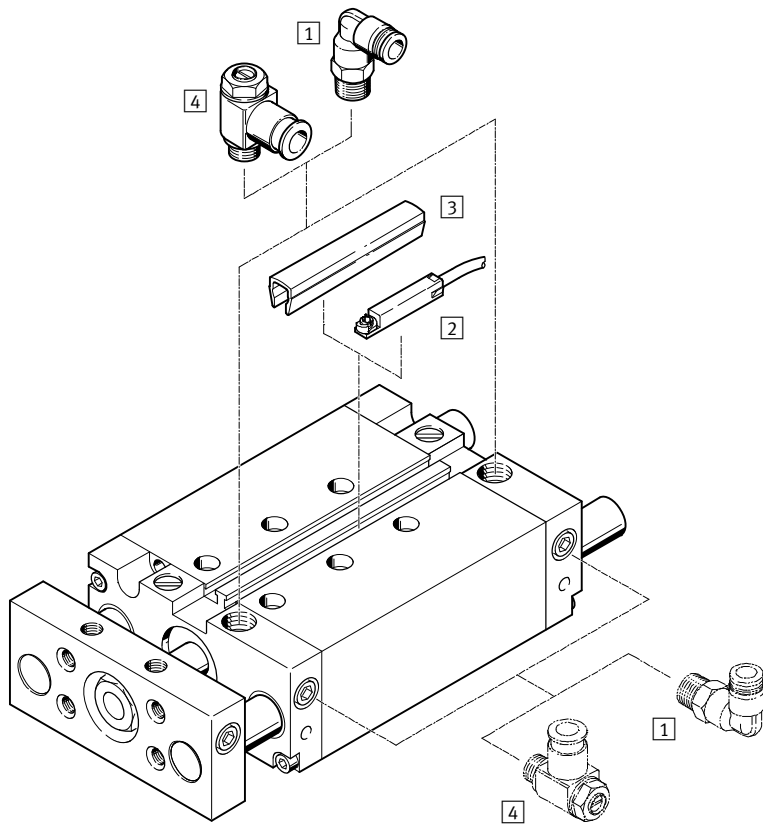

Variants

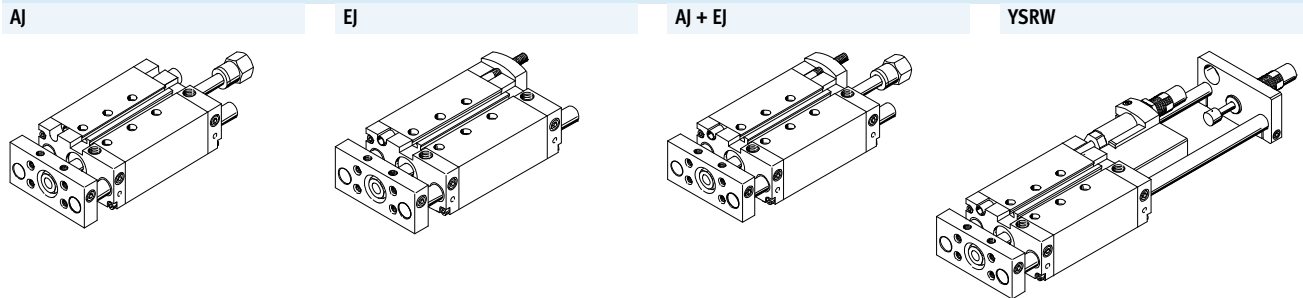

Accessories		Description	→ Page/Internet
1	Push-in fitting QS	For connecting compressed air tubing with standard O.D.	qs
2	Proximity sensor SME-/SMT-8/10	Can be integrated in the profile barrel	61
3	Slot cover ABP-5-S	To protect the sensor cable and keep dirt out of the sensor slots	62
4	One-way flow control valve GRLA	To regulate speed	62
-	Centring sleeves ZBH	4 or 6 pieces included in scope of delivery	60

-  Note
The proximity sensors SM...O-8E cannot be used with the DFM-B.

Guided drives DFM-B

Type codes

DFM - 50 - 80 - B - P - A - GF - S6 - AJ - ZUB - 10S - G

Type

DFM	Guided drive
-----	--------------

Piston Ø [mm]

Stroke [mm]

Generation

B	Series
---	--------

Cushioning

P	Flexible cushioning rings/plates at both ends
PPV	Pneumatic cushioning adjustable at both ends
YSRW	Self-adjusting at both ends

Position sensing

A	For proximity sensing
---	-----------------------

Guide

GF	Plain-bearing guide
KF	Recirculating ball bearing guide

Variant

S6	Heat-resistant seals up to max. 120 °C
----	--

Precision adjustment

AJ	Advanced end position
EJ	Retracted end position

Accessories

ZUB	Supplied separately
-----	---------------------

Slot cover

...S	Sensor slot
------	-------------

Proximity sensor

...G	With cable, 2.5 m
...I	Contactless with cable, 2.5 m

Guided drives DFM-B



Technical data

FESTO

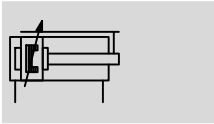
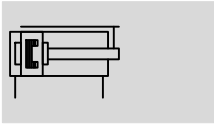
Function



 www.festo.com

-  Diameter
12 ... 63 mm
-  Stroke length
10 ... 400 mm

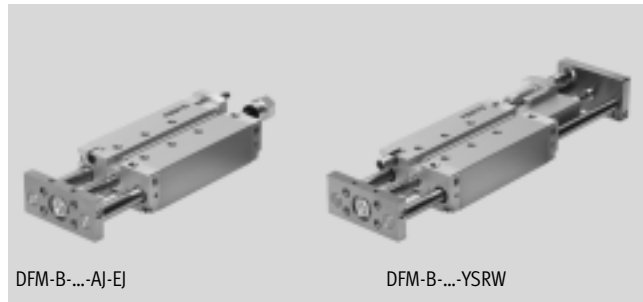
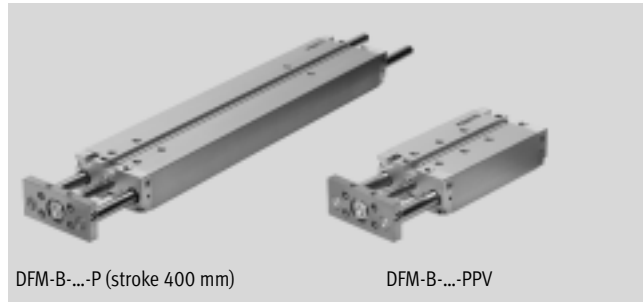

General technical data										
Piston \varnothing			12	16	20	25	32	40	50	63
Pneumatic connection			M5	M5	M5	G $\frac{1}{8}$	G $\frac{1}{8}$	G $\frac{1}{8}$	G $\frac{1}{4}$	G $\frac{1}{4}$
Operating medium			Compressed air in accordance with ISO 8573-1:2010 [7:4:4]							
Note on operating/pilot medium			Operation with lubricated medium possible (in which case lubricated operation will always be required)							
Operating pressure [bar]			2 ... 10	2 ... 10	2 ... 10	1.5 ... 10	1.5 ... 10	1.5 ... 10	1 ... 10	1 ... 10
Design			Piston							
			Piston rod							
			Guide rods with yoke							
Cushioning	P		Flexible cushioning rings/plates at both ends							
	PPV		Pneumatic cushioning adjustable at both ends							
	YSRW		Self-adjusting at both ends							
Cushioning length	PPV	[mm]	-	12	15	15	16	17	19	19
Position sensing			For proximity sensing							
Type of mounting			Via through-holes							
			Via female threads							
Assembly position			Any							
Protection against torsion/guide			Guide rod with yoke/with plain-bearing or ball bearing guide							
Variant AJ										
Setting range		[mm]	0 ... 10							
Variant EJ and YSRW										
Setting range		[mm]	-	-	0 ... 10					
Variant YSRW with shock absorber										
Repetition accuracy		[mm]	-	-	Max. 0.05					

- || - Note: This product conforms to ISO 1179-1 and to ISO 228-1

Guided drives DFM-B

Technical data

FESTO

Ambient conditions				
	Plain-bearing guide GF	Recirculating ball bearing guide KF	Variant YSRW with shock absorber	S6
Ambient temperature ¹⁾ [°C]	-20 ... +80	-5 ... +60	0 ... +60	0 ... +120
Corrosion resistance class CRC ²⁾	2	-	-	2
ATEX	Specified types → www.festo.com			

1) Note operating range of proximity sensors

2) Corrosion resistance class CRC 2 to Festo standard FN 940070

Moderate corrosion stress. Indoor applications in which condensation may occur. External visible parts with primarily decorative requirements for the surface and which are in direct contact with the ambient atmosphere typical for industrial applications.

Speeds [m/s]								
Piston Ø	12	16	20	25	32	40	50	63
Cushioning P, precision stroke adjustment AJ and E]								
Maximum speed advancing, retracting	0.8	0.8	0.8	0.8	0.8	0.8	0.6	0.6
Cushioning P, plain-bearing guide GF in combination with S6								
Maximum speed advancing, retracting	0.5	0.5	0.5	0.5	0.5	0.5	0.4	0.4
Cushioning PPV, YSRW, PPV S6								
Maximum speed advancing, retracting	-	1.5	1.5	1.5	1.5	1.5	1	1

Forces [N]								
Piston Ø	12	16	20	25	32	40	50	63
Cushioning P, PPV, YSRW, precision stroke adjustment E]								
Theoretical force at 6 bar, advancing	68	121	188	295	482	754	1178	1870
Theoretical force at 6 bar, retracting	51	90	141	247	415	686	1057	1750
Precision stroke adjustment AJ and AJ+E]								
Theoretical force at 6 bar, advancing	51	90	141	247	415	686	1057	1750
Theoretical force at 6 bar, retracting	51	90	141	247	415	686	1057	1750

Guided drives DFM-B

Technical data



Impact energy [J]								
Piston Ø	12	16	20	25	32	40	50	63
Cushioning P								
Max. impact energy at the end positions	0.09	0.15	0.2	0.35	0.40	0.7	1.0	1.3
Max. impact energy at the end positions S6	0.035	0.075	0.1	0.15	0.2	0.35	0.5	0.65
Cushioning YSRW								
Max. energy absorption per stroke	-	-	4	8	12	35	35	70
Max. energy absorption per hour	-	-	21000	30000	41000	68000	68000	100000

Permissible impact velocity:
$$v_{perm.} = \sqrt{\frac{2 \times E_{perm.}}{m_{dead} + m_{load}}}$$

$v_{perm.}$ Permissible impact velocity
 $E_{perm.}$ Max. impact energy
 m_{dead} Moving load (drive)
 m_{load} Moving work load

 Note
 These specifications represent the maximum values which can be reached. Note the maximum permitted impact energy.

Maximum permissible load:
$$m_{load} = \frac{2 \times E_{perm.}}{v^2} - m_{dead}$$

DFM-B with plain-bearing guide GF, cushioning P, PPV								
Stroke [mm]	Piston Ø [mm]							
	12	16	20	25	32	40	50	63
Product weight [g]								
10	385	621	-	-	-	-	-	-
20	432	680	1026	1474	2163	-	-	-
25	452	706	1068	1530	2238	2606	4290	5568
30	476	736	1109	1586	2337	-	-	-
40	523	795	1215	1726	2489	-	-	-
50	570	854	1298	1838	2640	3047	5019	6457
80	712	1033	1572	2218	3210	3663	5909	7503
100	803	1148	1733	2435	3502	3981	6376	8116
125	962	1352	2000	2800	4018	4534	7151	9050
160	1128	1560	2293	3193	4549	5118	8017	10137
200	1318	1797	2628	3642	5158	5786	9007	11379
250	-	-	3237	4430	6259	6962	10813	13509
320	-	-	3823	5215	7322	8129	12545	15682
400	-	-	4493	6113	8537	9462	14525	18165
Moving load [g]								
10	201	283	-	-	-	-	-	-
20	216	302	506	715	1147	-	-	-
25	223	312	520	734	1176	1305	2217	2640
30	230	322	534	753	1230	-	-	-
40	245	342	586	823	1289	-	-	-
50	260	362	615	861	1347	1476	2567	2990
80	304	423	724	1022	1644	1776	3002	3426
100	333	463	781	1098	1764	1893	3189	3613
125	420	579	917	1289	2059	2188	3586	4009
160	472	649	1016	1422	2264	2393	3913	4336
200	530	730	1129	1573	2499	2627	4286	4710
250	-	-	1489	2017	3164	3293	5351	5774
320	-	-	1688	2283	3574	3703	6005	6428
400	-	-	1914	2587	4042	4171	6752	7176

Guided drives DFM-B

Technical data

FESTO

DFM-B with plain-bearing guide GF, cushioning P, PPV, variant S6								
Stroke [mm]	Piston Ø [mm]							
	12	16	20	25	32	40	50	63
Product weight [g]								
0	283	488	745	1080	1594	1847	3124	3992
10	328	548	–	–	–	–	–	–
20	376	607	907	1298	1889	–	–	–
25	395	633	949	1354	1964	2257	3735	4762
30	419	663	990	1410	2063	–	–	–
40	466	722	1096	1550	2215	–	–	–
50	514	781	1179	1662	2366	2698	4464	5651
80	656	959	1452	2042	2936	3314	5354	6696
100	747	1074	1614	2259	3228	3632	5821	7310
125	905	1279	1880	2624	3745	4186	6596	8244
160	1072	1486	2173	3017	4276	4770	7462	9331
200	1261	1724	2508	3466	4884	5437	8452	10573
250	–	–	3118	4254	5985	6613	10258	12703
320	–	–	3704	5039	7048	7780	11990	14876
400	–	–	4374	5937	8264	9114	19970	17359
Moving load [g]								
0	130	188	329	463	755	810	1428	1601
10	145	208	–	–	–	–	–	–
20	159	229	386	539	873	–	–	–
25	167	239	400	558	902	956	1662	1834
30	174	249	414	577	956	–	–	–
40	188	269	467	647	1015	–	–	–
50	203	289	495	685	1073	1127	2012	2184
80	247	349	604	847	1373	1427	2447	2620
100	276	389	661	922	1490	1544	2634	2806
125	364	506	797	1113	1785	1840	3031	3203
160	415	576	896	1246	1990	2045	3358	3530
200	474	657	1010	1397	2225	2279	3731	3904
250	–	–	1370	1842	2890	2944	4796	4968
320	–	–	1568	2107	3300	3354	5450	5622
400	–	–	1794	2411	3768	3823	6197	6370

Guided drives DFM-B



Technical data

DFM-B with recirculating ball bearing guide KF, cushioning P, PPV								
Stroke [mm]	Piston Ø [mm]							
	12	16	20	25	32	40	50	63
Product weight [g]								
10	345	543	–	–	–	–	–	–
20	388	596	935	1395	1932	–	–	–
25	405	619	974	1447	1998	2366	3907	5185
30	427	647	1012	1499	2079	–	–	–
40	470	700	1105	1624	2213	–	–	–
50	513	754	1181	1729	2346	2753	4523	5961
80	641	916	1428	2074	2817	3270	5272	6865
100	723	1020	1577	2276	3073	3552	5682	7423
125	852	1190	1809	2599	3490	4006	6327	8226
160	1002	1378	2079	2966	3958	4526	7094	9214
200	1174	1593	2388	3384	4494	5121	7971	10343
250	–	–	2905	4073	5369	6072	9419	12115
320	–	–	3445	4805	6305	7112	10953	14091
400	–	–	4063	5642	7376	8301	12707	16347
Moving load [g]								
10	168	239	–	–	–	–	–	–
20	178	254	437	631	933	–	–	–
25	183	261	447	646	954	1082	1830	2254
30	188	268	458	661	990	–	–	–
40	198	283	498	716	1030	–	–	–
50	208	297	520	746	1071	1199	2067	2491
80	238	341	602	873	1271	1400	2361	2785
100	259	370	646	934	1352	1481	2492	2915
125	316	452	748	1083	1548	1677	2758	3182
160	352	503	824	1189	1690	1819	2986	3410
200	392	561	911	1310	1852	1981	3247	3671
250	–	–	1180	1656	2291	2420	3953	4377
320	–	–	1332	1868	2575	2703	4410	4833
400	–	–	1505	2111	2899	3027	4931	5355

Guided drives DFM-B

Technical data

FESTO

Additional weights with precision stroke adjustment AJ – GF, KF

When using the precision stroke adjustment AJ, the following weight must be taken into account in addition to the load specified from page 32:

Product weight [g] precision stroke adjustment AJ (piston rod + stop)								
Stroke [mm]	Piston Ø [mm]							
	12	16	20	25	32	40	50	63
10	55.4	58.8	–	–	–	–	–	–
20	57.6	61	75.6	115.4	185.7	–	–	–
25	58.7	62.1	77.6	118.5	190.2	188.7	350.7	350.5
30	59.9	63.3	79.6	121.6	194.7	–	–	–
40	62.1	65.5	83.6	127.8	203.6	–	–	–
50	64.3	67.7	87.5	134	212.5	211	390.4	390.2
80	71	74.4	99.5	152.6	239.3	237.8	438	437.8
100	75.5	78.9	107.5	165	257.2	255.7	469.8	469.6
125	81.1	84.5	117.3	180.5	279.5	278	509.5	509.3
160	88.9	92.3	131.2	202.5	310.8	309.3	565.1	564.9
200	97.8	101.2	147.1	227	346.5	345	628.6	628.4
250	–	–	167	258.1	391.2	389.7	708.1	707.9
320	–	–	194.8	301.5	453.8	452.3	819.2	819
400	–	–	226.5	351.1	525.2	523.7	946.3	946.1

Moving load [g] precision stroke adjustment AJ (piston rod + stop)								
Stroke [mm]	Piston Ø [mm]							
	12	16	20	25	32	40	50	63
10	51.5	52.3	–	–	–	–	–	–
20	53.7	54.5	76	116.6	185.9	–	–	–
25	54.8	55.6	78	119.7	190.4	190	351.7	351.7
30	56	56.8	80	122.8	194.9	–	–	–
40	58.2	59	84	129	203.8	–	–	–
50	60.4	61.2	87.9	135.2	212.7	212.7	391.4	391.4
80	67.1	67.9	99.9	153.8	239.5	239.5	439	439
100	71.6	72.4	107.8	166.2	257.4	257.4	470.8	470.8
125	77.2	78	117.7	181.7	279.7	279.7	510.5	510.5
160	85	85.8	131.6	203.4	311	311	566.1	566.1
200	93.9	94.7	147.5	228.2	346.7	346.7	629.6	629.6
250	–	–	167.4	259.3	391.4	391.4	709.1	709.1
320	–	–	195.2	302.7	454	454	820.2	820.2
400	–	–	226.9	352.3	525.4	525.4	947.3	947.3

Guided drives DFM-B

Technical data

FESTO

Additional weights with precision stroke adjustment EJ – GF, KF

When using the precision stroke adjustment EJ, the following weight must be taken into account in addition to the load specified from page 32:

Product weight [g] precision stroke adjustment EJ (piston rod + stop)						
Stroke [mm]	Piston Ø [mm]					
	20	25	32	40	50	63
20	55.7	117.1	134.1	–	–	–
25	56.4	119.1	136.1	153.9	302.8	354
30	57.2	121	138	–	–	–
40	58.8	125	142	–	–	–
50	60.3	129	146	163.8	318.3	369.5
80	65	140.9	157.9	175.7	336.9	388.1
100	68.1	148.8	165.8	183.6	349.4	400.6
125	71.9	158.8	175.8	193.6	364.9	416.1
160	77.4	172.7	189.7	207.5	386.6	437.8
200	83.6	188.5	205.5	223.3	411.4	462.6
250	91.3	208.4	225.4	243.2	442.4	493.6
320	102.2	236.2	253.2	271	485.9	537.1
400	114.6	268	285	302.8	535.5	586.7

DFM-B with recirculating ball bearing guide KF, cushioning YSRW						
Stroke [mm]	Piston Ø [mm]					
	20	25	32	40	50	63
Product weight [g]						
20	1684	2641	3717	–	–	–
25	1733	2707	3801	4995	7594	10816
30	1780	2773	3884	–	–	–
40	1874	2903	4053	–	–	–
50	1970	3035	4222	5455	8275	11657
80	2257	3429	4720	5999	9092	12629
100	2444	3687	5047	6352	9614	13298
125	2677	4008	5458	6801	10294	14137
160	3015	4473	6050	7446	11255	15319
200	3401	5004	6728	8183	12354	16670
250	3855	5641	7545	9074	13700	18340
320	4530	6569	8730	10363	15623	20704
400	5302	7631	10085	11837	17821	23405
Moving load [g]						
20	874	1323	1933	–	–	–
25	894	1350	1969	2386	3735	4996
30	914	1378	2005	–	–	–
40	953	1432	2077	–	–	–
50	993	1487	2149	2566	4021	5282
80	1111	1650	2365	2782	4365	5625
100	1190	1759	2509	2926	4594	5855
125	1289	1896	2690	3106	4880	6141
160	1427	2087	2942	3359	5281	6542
200	1585	2305	3230	3647	5739	7000
250	1782	2578	3590	4007	6312	7572
320	2059	2959	4095	4512	7114	8374
400	2375	3396	4671	5088	8030	9290

Guided drives DFM-B

Technical data

Materials

Sectional view

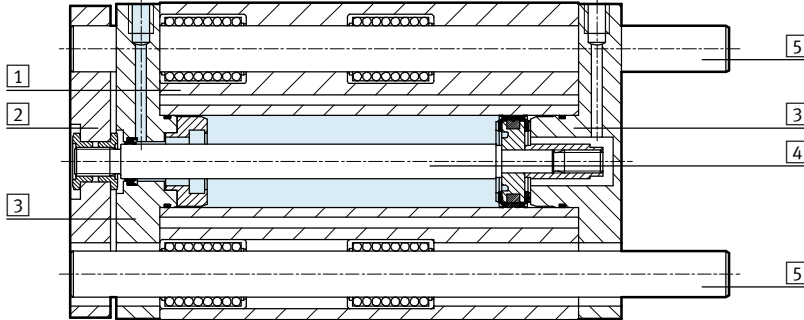

Variant	Plain-bearing guide GF	Recirculating ball bearing guide KF	S6
1 Housing	Wrought aluminium alloy, anodised	Wrought aluminium alloy, anodised	Wrought aluminium alloy, anodised
2 Yoke plate	Tempered steel	Tempered steel	Wrought aluminium alloy
3 Bearing and end caps	Wrought aluminium alloy, anodised	Wrought aluminium alloy, anodised	Wrought aluminium alloy, anodised
4 Piston rod	High-alloy stainless steel	High-alloy stainless steel	High-alloy stainless steel
5 Guide rods	High-alloy steel	Tempered steel	High-alloy steel
- Static seals	Nitrile rubber	Nitrile rubber	Fluoro rubber
- Dynamic seals	Polyurethane	Polyurethane	Fluoro rubber
Note on materials	RoHS compliant		

Maximum effective load F [N]

Plain-bearing guide GF and recirculating ball bearing guide KF

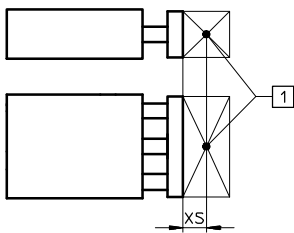

1 Centre of gravity of effective load

Piston Ø [mm]	XS [mm]	Stroke [mm]	Stroke [mm]															
			10	20	25	30	40	50	80	100	125	160	200	250	320	400		
12	GF	25	53	47	45	43	39	36	28	25	23	20	15	-	-	-		
	KF		47	42	40	38	35	32	26	23	20	16	13	-	-	-		
16	GF	50	95	86	83	79	73	67	55	49	37	30	25	-	-	-		
	KF		75	69	66	64	58	56	51	48	30	21	17	-	-	-		
20	GF	50	-	99	96	92	110	103	86	77	71	63	55	47	41	35		
	KF		-	80	77	75	91	88	80	75	65	56	47	40	34	29		
25	GF	50	-	121	116	112	123	115	96	86	86	76	67	53	45	39		
	KF		-	88	86	84	100	97	89	85	80	66	56	46	38	32		
32	GF	50	-	188	180	173	161	150	166	150	168	146	127	106	91	78		
	KF		-	120	118	116	112	109	134	128	144	135	126	135	125	100		
40	GF	50	-	-	180	-	-	150	166	150	168	146	127	106	91	78		
	KF		-	-	118	-	-	109	134	128	144	135	126	135	125	100		
50	GF	50	-	-	257	-	-	216	234	212	229	200	174	145	124	105		
	KF		-	-	182	-	-	168	201	193	211	199	188	179	158	130		
63	GF	50	-	-	257	-	-	216	234	212	229	200	174	145	124	105		
	KF		-	-	182	-	-	168	201	193	211	199	188	179	158	130		

- - Note

GSED
sizing software
→ www.festo.com

Guided drives DFM-B

Technical data

FESTO

Permissible torque load M [Nm]

Plain-bearing guide GF and recirculating ball bearing guide KF

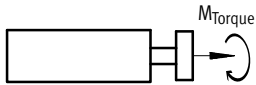

Piston \varnothing [mm]		Stroke [mm]													
		10	20	25	30	40	50	80	100	125	160	200	250	320	400
12	GF	1.10	0.95	0.90	0.85	0.80	0.75	0.60	0.50	0.45	0.40	0.30	-	-	-
	KF	0.95	0.85	0.80	0.75	0.70	0.65	0.50	0.45	0.40	0.30	0.25	-	-	-
16	GF	2.20	2.00	1.90	1.80	1.70	1.50	1.30	1.10	0.85	0.70	0.60	-	-	-
	KF	1.70	1.60	1.50	1.45	1.35	1.30	1.20	1.10	0.70	0.50	0.40	-	-	-
20	GF	-	2.90	2.80	2.70	3.20	3.00	2.50	2.20	2.10	1.80	1.60	1.40	1.20	1.00
	KF	-	2.30	2.20	2.15	2.60	2.55	2.30	2.20	1.90	1.60	1.40	1.20	1.00	0.85
25	GF	-	4.15	3.95	3.80	4.20	3.90	3.25	2.90	2.90	2.60	2.30	1.80	1.50	1.30
	KF	-	3.00	2.92	2.85	3.40	3.30	3.02	2.89	2.70	2.20	1.90	1.50	1.30	1.10
32	GF	-	7.30	7.00	6.70	6.20	5.80	6.40	5.80	6.50	5.70	5.00	4.10	3.50	3.00
	KF	-	4.70	4.60	4.55	4.40	4.25	5.25	5.00	5.60	5.25	4.90	5.20	4.80	3.90
40	GF	-	-	7.90	-	-	6.55	7.25	6.55	7.35	6.40	5.55	4.60	4.0	3.40
	KF	-	-	5.20	-	-	4.80	5.90	5.65	6.35	5.95	5.55	5.95	5.50	4.40
50	GF	-	-	14.15	-	-	11.85	12.85	11.65	12.55	11.00	9.60	7.98	6.82	5.78
	KF	-	-	10.00	-	-	9.30	11.00	10.6	11.60	11.00	10.30	9.82	8.67	7.17
63	GF	-	-	15.90	-	-	13.30	14.45	13.10	14.10	12.30	10.70	9.06	7.75	6.56
	KF	-	-	11.30	-	-	10.50	12.50	12.00	13.20	12.40	11.70	11.16	9.85	8.15

Torsional backlash ρ

Plain-bearing guide GF and recirculating ball bearing guide KF in retracted state, without load

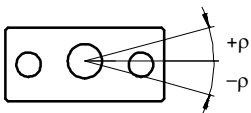

Piston \varnothing		12	16	20	25	32	40	50	63
Torsional backlash [°]	GF	0.09	0.09	0.07	0.07	0.06	0.06	0.05	0.05
	KF	0.08	0.08	0.07	0.07	0.05	0.05	0.05	0.05

Guided drives DFM-B

Technical data

Deflection of piston rod

Mean deflection f_1 due to bearing backlash as a function of the stroke l

DFM-GF with 2 bearings per guide rod

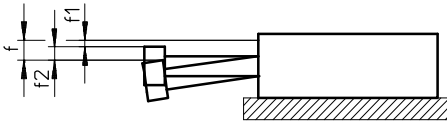

$$f = f_1 + f_2$$

f = Total deflection of piston rod

f_1 = Deflection due to bearing backlash

f_2 = Deflection due to lateral force

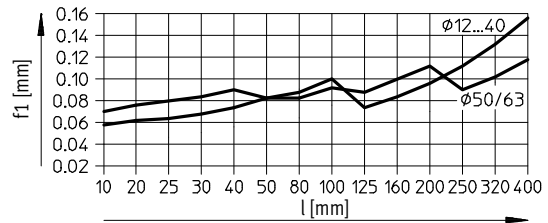

Deflection f_2 due to lateral force F as a function of the stroke with plain-bearing guide GF

Stroke 50 mm

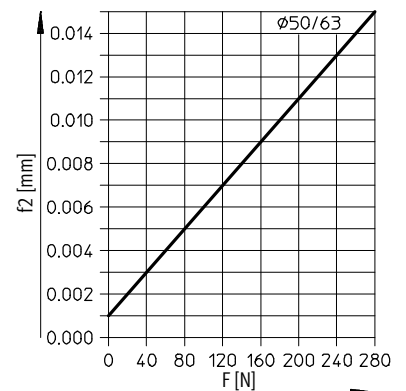
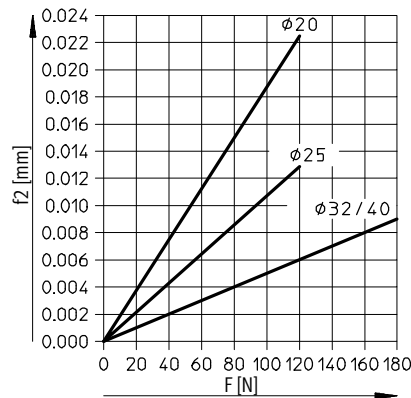
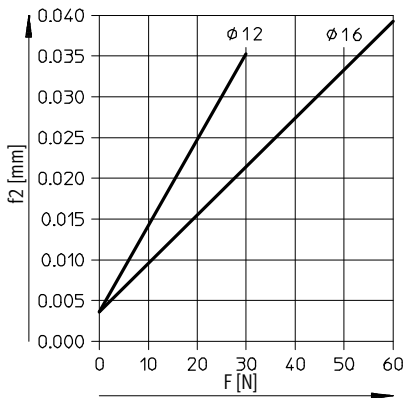

Stroke 100 mm

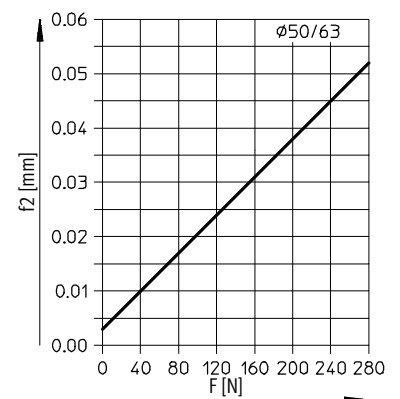
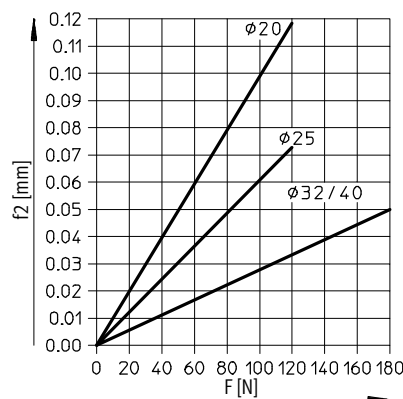
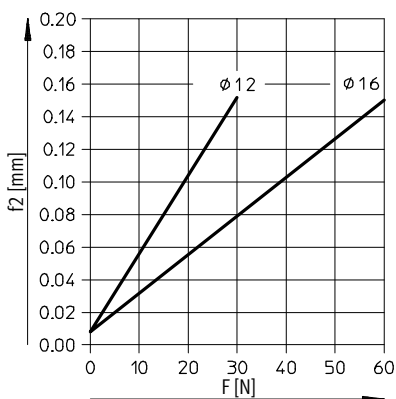

Guided drives DFM-B

Technical data



Deflection of piston rod

Mean deflection f_1 due to bearing backlash as a function of the stroke l

DFM-GF with 2 bearings per guide rod

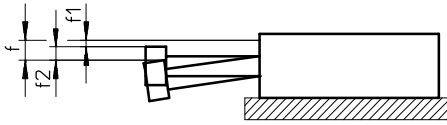

$$f = f_1 + f_2$$

f = Total deflection of piston rod

f_1 = Deflection due to bearing backlash

f_2 = Deflection due to lateral force

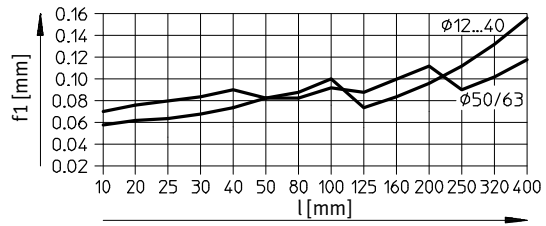

Deflection f_2 due to lateral force F as a function of the stroke with plain-bearing guide GF

Stroke 200 mm

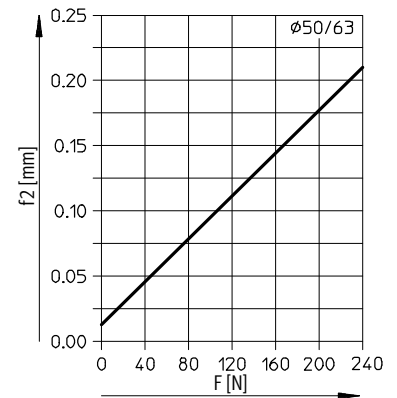
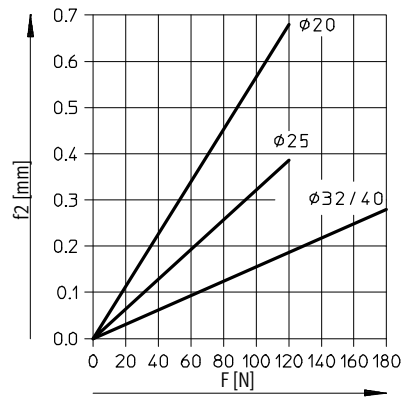
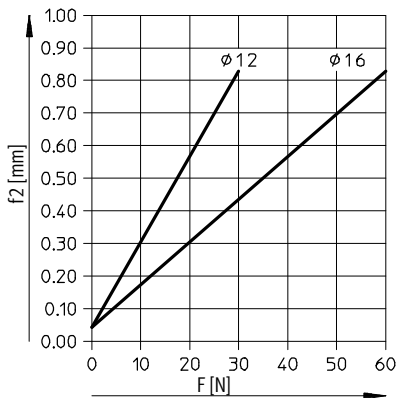

Stroke 400 mm

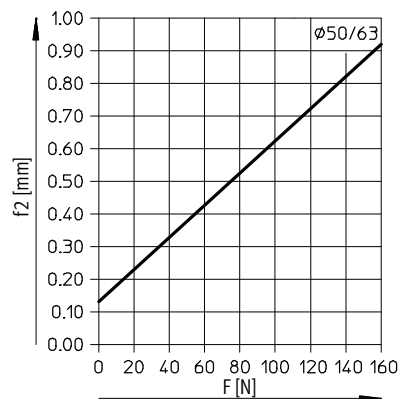
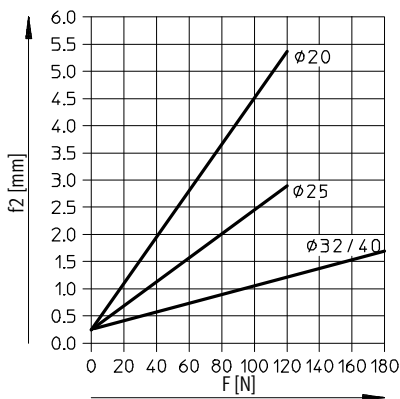

Guided drives DFM-B

Technical data

Deflection of piston rod

Mean deflection f_1 due to bearing backlash as a function of the stroke l

DFM-KF with 2 bearings per guide rod

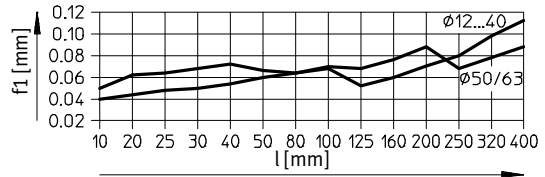
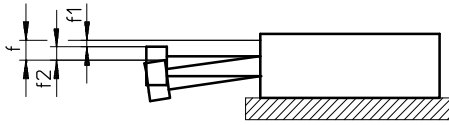

$$f = f_1 + f_2$$

f = Total deflection of piston rod

f_1 = Deflection due to bearing backlash

f_2 = Deflection due to lateral force

Deflection f_2 due to lateral force F as a function of the stroke with recirculating ball bearing guide KF

Stroke 50 mm

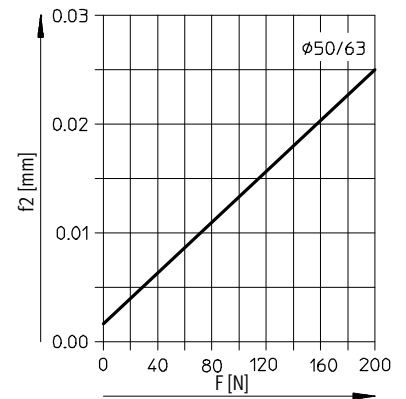
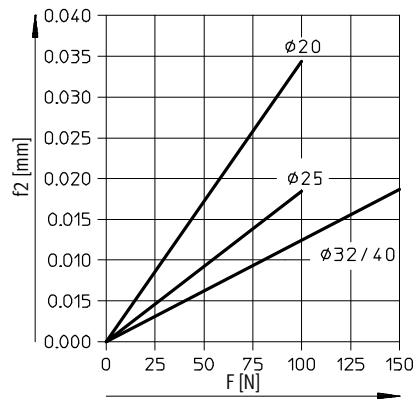
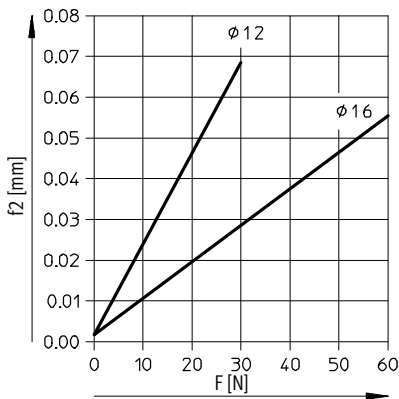

Stroke 100 mm

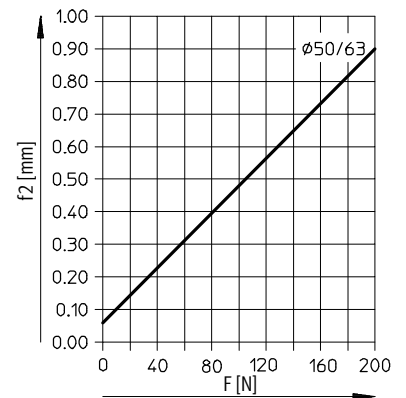
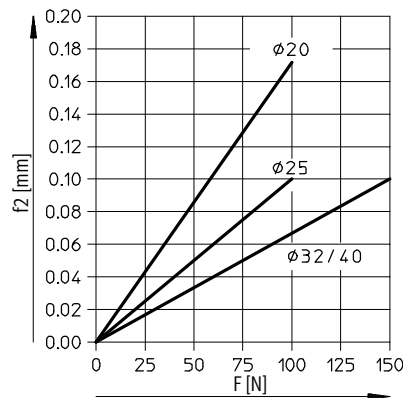
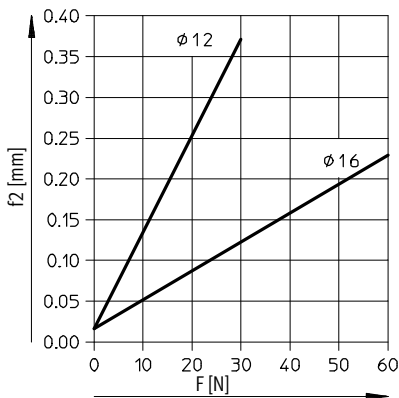

Guided drives DFM-B

Technical data



Deflection of piston rod

Mean deflection f_1 due to bearing backlash as a function of the stroke l

DFM-KF with 2 bearings per guide rod

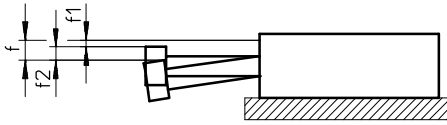

$$f = f_1 + f_2$$

f = Total deflection of piston rod

f_1 = Deflection due to bearing backlash

f_2 = Deflection due to lateral force

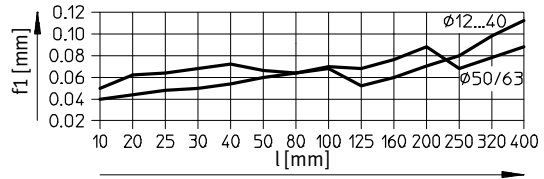

Deflection f_2 due to lateral force F as a function of the stroke with recirculating ball bearing guide KF

Stroke 200 mm

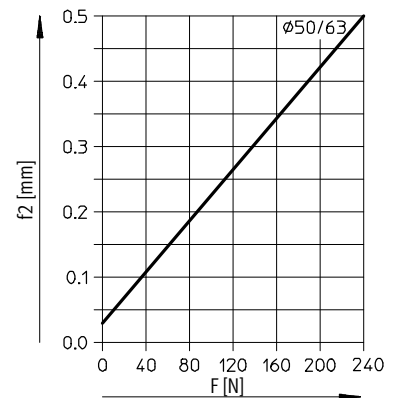
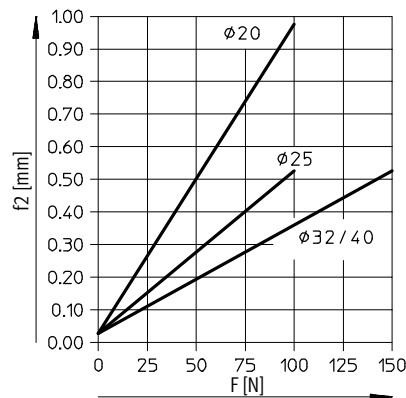
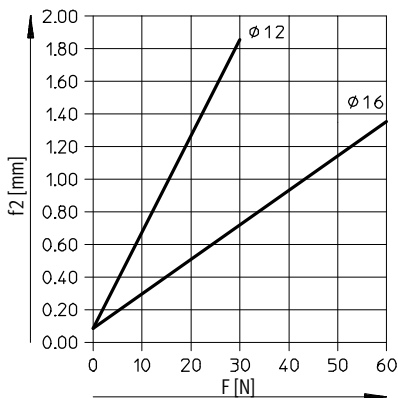

Stroke 400 mm

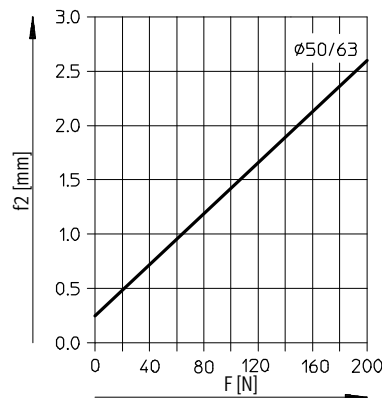
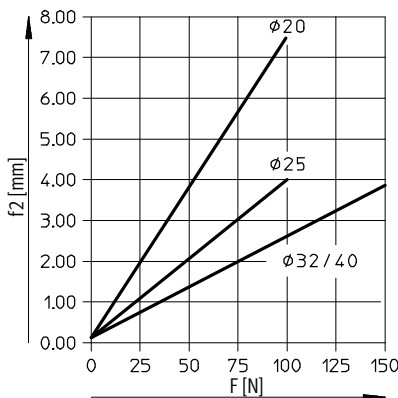

Guided drives DFM-B

Technical data

Used as lifting cylinder

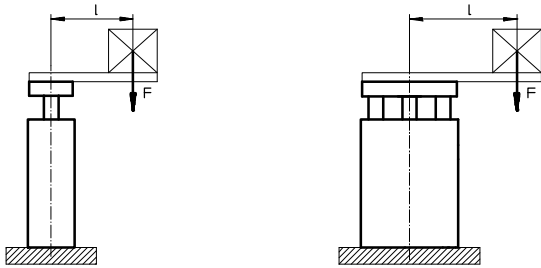

- - Note

Additional graphs → starting on page 14.

F = Longitudinal force [N]
l = Lever arm [mm]

Permissible load with plain-bearing guide GF

Stroke 40 ... 400 mm

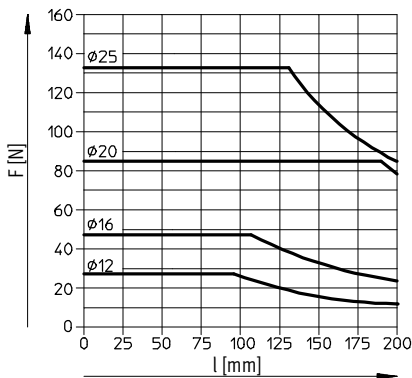

Stroke 250 ... 400 mm

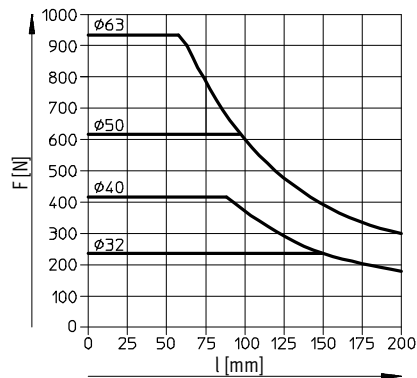

Permissible load with recirculating ball bearing guide KF

Stroke 40 ... 100 mm

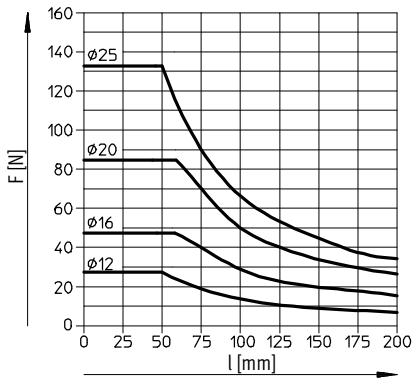

Stroke 125 ... 200 mm

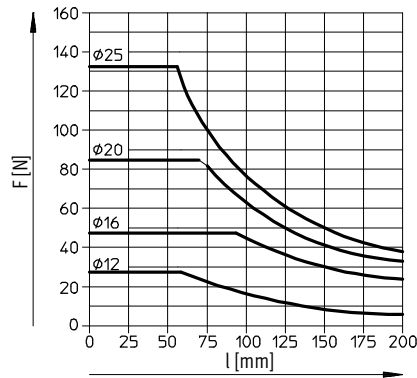

Stroke 250 ... 400 mm

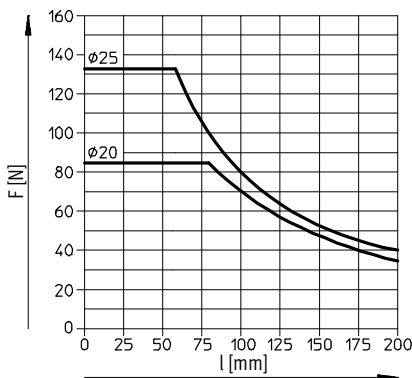

Stroke 200 ... 400 mm

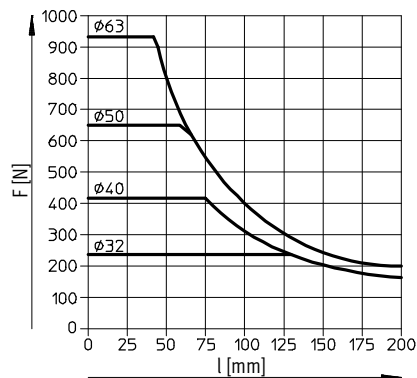

Guided drives DFM-B

Technical data

Permissible load m as a function of the permissible speed v

Horizontal operation, cushioning YSRW

DFM-20...-B-YSRW

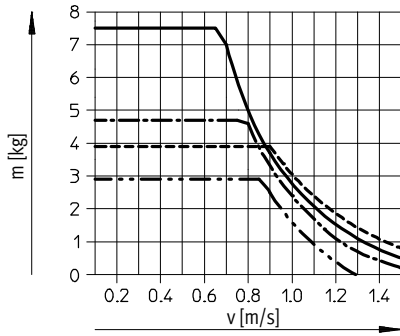

DFM-25...-B-YSRW

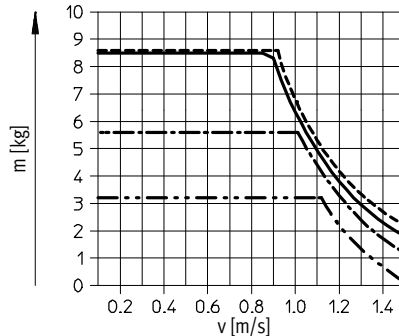

DFM-32...-B-YSRW

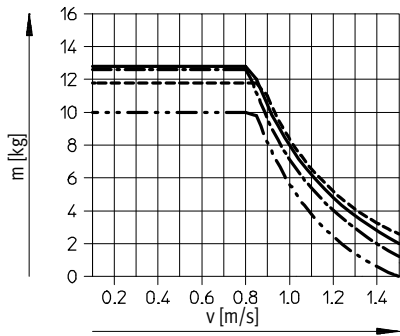

DFM-40...-B-YSRW

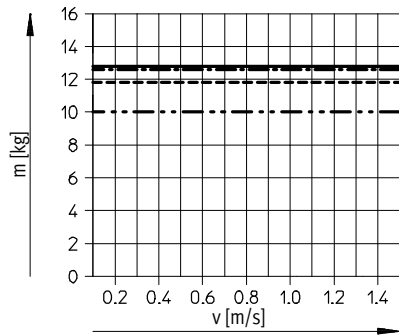

DFM-50...-B-YSRW

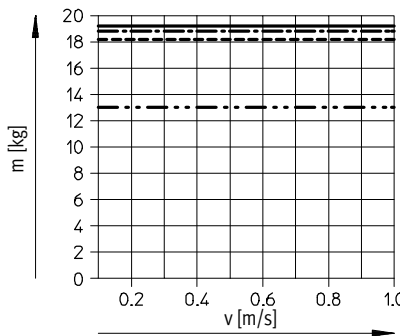

DFM-63...-B-YSRW

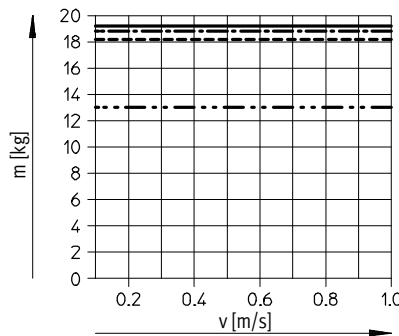

- 25 mm stroke
- 100 mm stroke
- · - · - 200 mm stroke
- · · · · 400 mm stroke

Guided drives DFM-B

Technical data

Vertical operation, cushioning YSRW

DFM-20...-B-YSRW

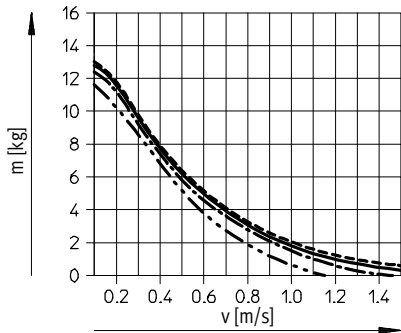

DFM-25...-B-YSRW

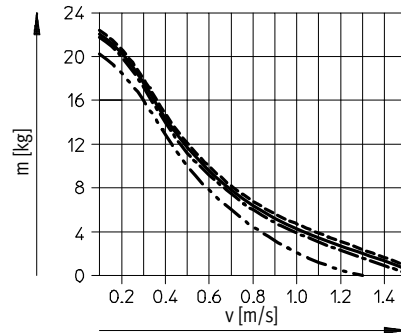

DFM-32...-B-YSRW

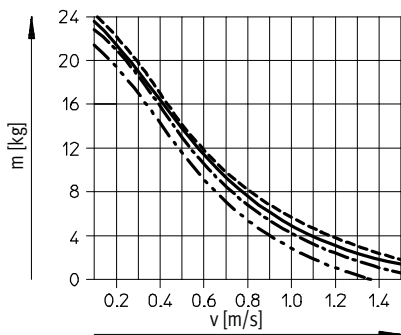

DFM-40...-B-YSRW

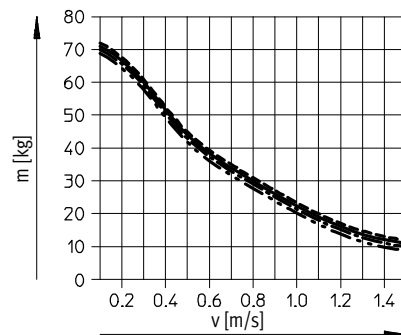

DFM-50...-B-YSRW

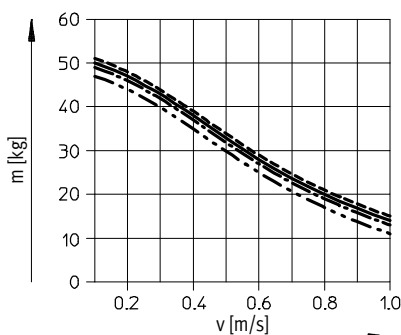

DFM-63...-B-YSRW

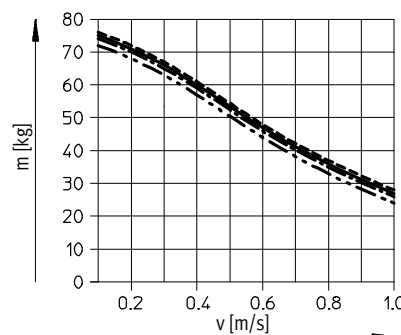

- 25 mm stroke
- 100 mm stroke
- · - · - 200 mm stroke
- · · · · 400 mm stroke

Guided drives DFM-B

Technical data



Dimensions

Piston \varnothing 12, 16 mm

Download CAD data → www.festo.com

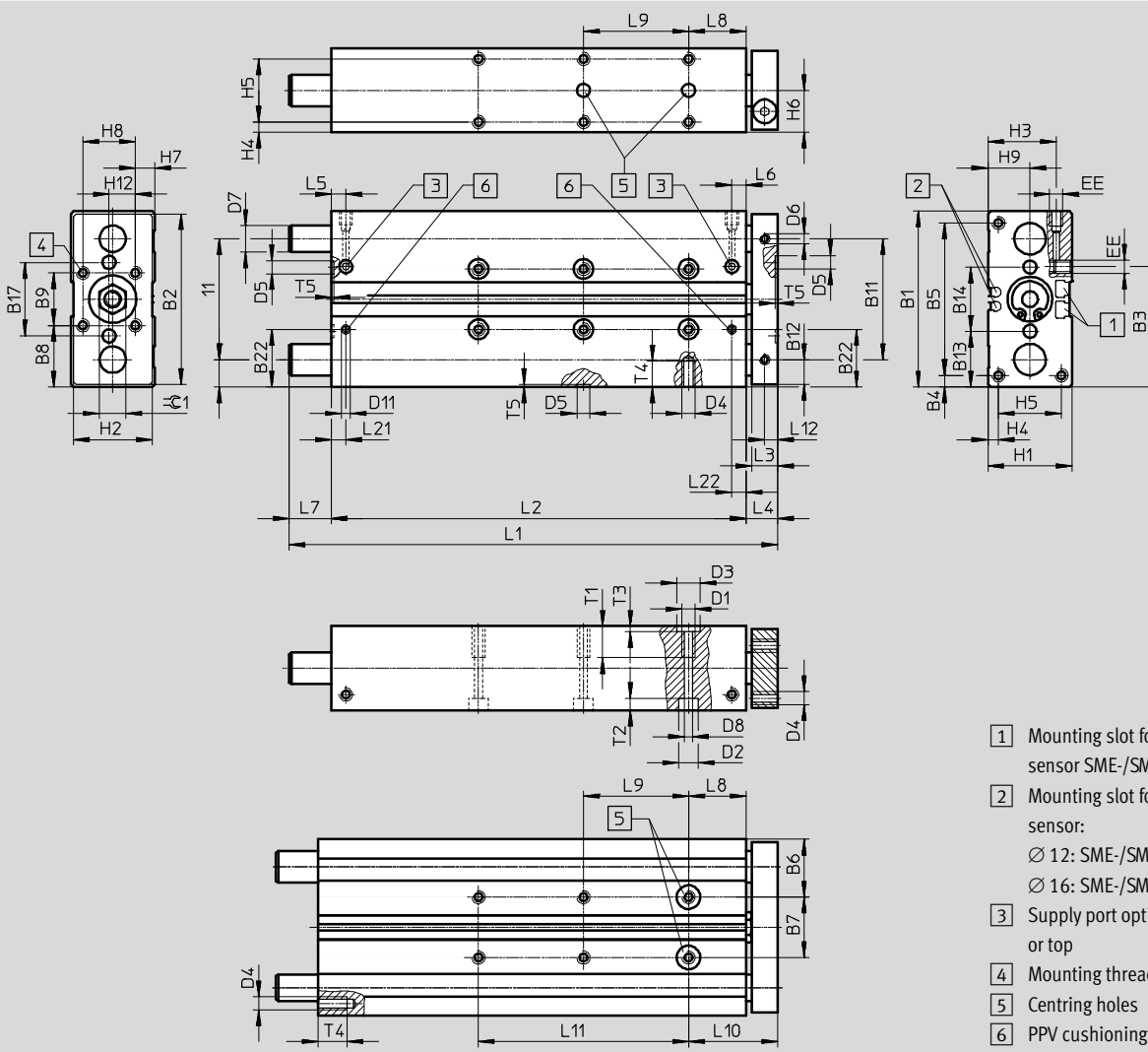

- 1 Mounting slot for proximity sensor SME-/SMT-8
- 2 Mounting slot for proximity sensor:
 \varnothing 12: SME-/SMT-10
 \varnothing 16: SME-/SMT-8
- 3 Supply port optionally at side or top
- 4 Mounting thread
- 5 Centring holes
- 6 PPV cushioning

\varnothing	B1	B2	B3	B4	B5	B6	B7	B8	B9	B10	B11	B12	B13	B14	B17	B22	D1
[mm]							$\pm 0.02^1$							$\pm 0.02^1$			
12	60	58	40.7	4.5	51	20.5	19	20	20	9.5	41	8.5	19.5	21	25	-	M5
16	67	65	45	4.5	58	22	23	23.5	20	10.5	46	9.5	21.3	24.4	28	22.5	M5

1) Tolerance between centring holes

\varnothing	D2	D3	D4	D5	D6	D7		D8	D11	EE	H1	H2	H3	H4	H5	H6	H7
[mm]	\varnothing	\varnothing		\varnothing	\varnothing		\varnothing	\varnothing	\varnothing								
		H7		H7		GF	KF	H7									
12	8	9	M4	5	M4	10 _{h8}	8 _{h6}	4.3	-	M5	28	26	24	4	20	14	4
16	7.5	9	M5	5	M4	12 _{h8}	10 _{h6}	4.3	3.3	M5	32	30	26.5	4	24	16	7.4

\varnothing	H8	H9	H12	L3	L4	L5	L6	L8	L10	L12	L21	L22	T1	T2	T3	T4	T5	$\approx \varnothing 1$
[mm]																		
12	20	14	10	10	13	14.8	11.2	21	34	5	-	-	10	9.4	2.1	8	1.2	10
16	20	16	10	10	12	9.8	9.3	22	34	5	9.8	9.3	12	4.6	2.1	10	1.2	10

Guided drives DFM-B

Technical data

Stroke [mm]	Piston Ø [mm]									
	12					16				
	L1	L2	L7	L9 ±0.02 ¹⁾	L11	L1	L2	L7	L9 ±0.02 ¹⁾	L11
10	74	50	11	-	-	80	68	-	-	-
20	84	60	11	-	-	90	78	-	-	-
25	89	65	11	20	-	95	83	-	20	-
30	94	70	11	20	-	100	88	-	20	-
40	104	80	11	20	-	110	98	-	20	-
50	114	90	11	40	-	120	108	-	40	-
80	144	120	11	40	-	150	138	-	40	-
100	164	140	11	40	80	170	158	-	40	80
125	230	165	52	40	80	229	183	34	40	80
160	265	200	52	40	120	264	218	34	40	120
200	305	240	52	40	160	304	258	34	40	160

1) Tolerance between centring holes

 Note

If the guide rods project beyond the housing when the unit is in its retracted end position (→ dimension L7), a recess must be provided in the mounting surface if the unit is to be mounted against a surface in order to allow the guide rods to move freely.

When using a variable stroke, the dimensions L1, L2, L7, L9 and L11 correspond to the next longest standard stroke.

Dimensions Download CAD data → www.festo.com

AJ – Precision stroke adjustment, advanced end position
 Ø 12, 16 mm

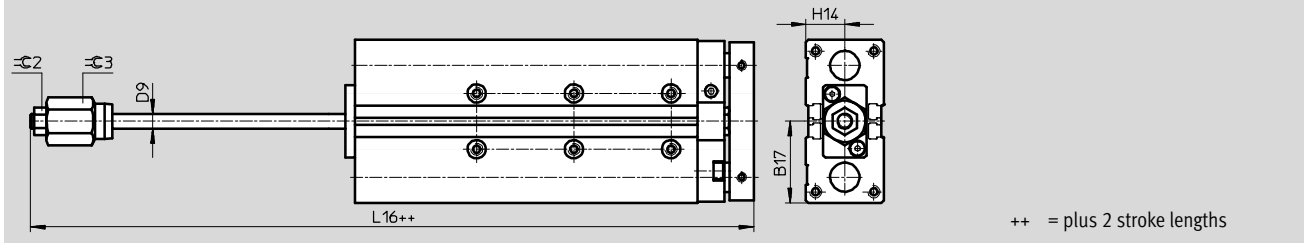

Ø	B17	D9 Ø	H14	L16	C2	C3
12	30.5	6	14	90.6	10	17
16	33.5	6	16	107.9	10	17

Guided drives DFM-B

Technical data

FESTO

Dimensions

Piston \varnothing 20 ... 40 mm

Download CAD data → www.festo.com

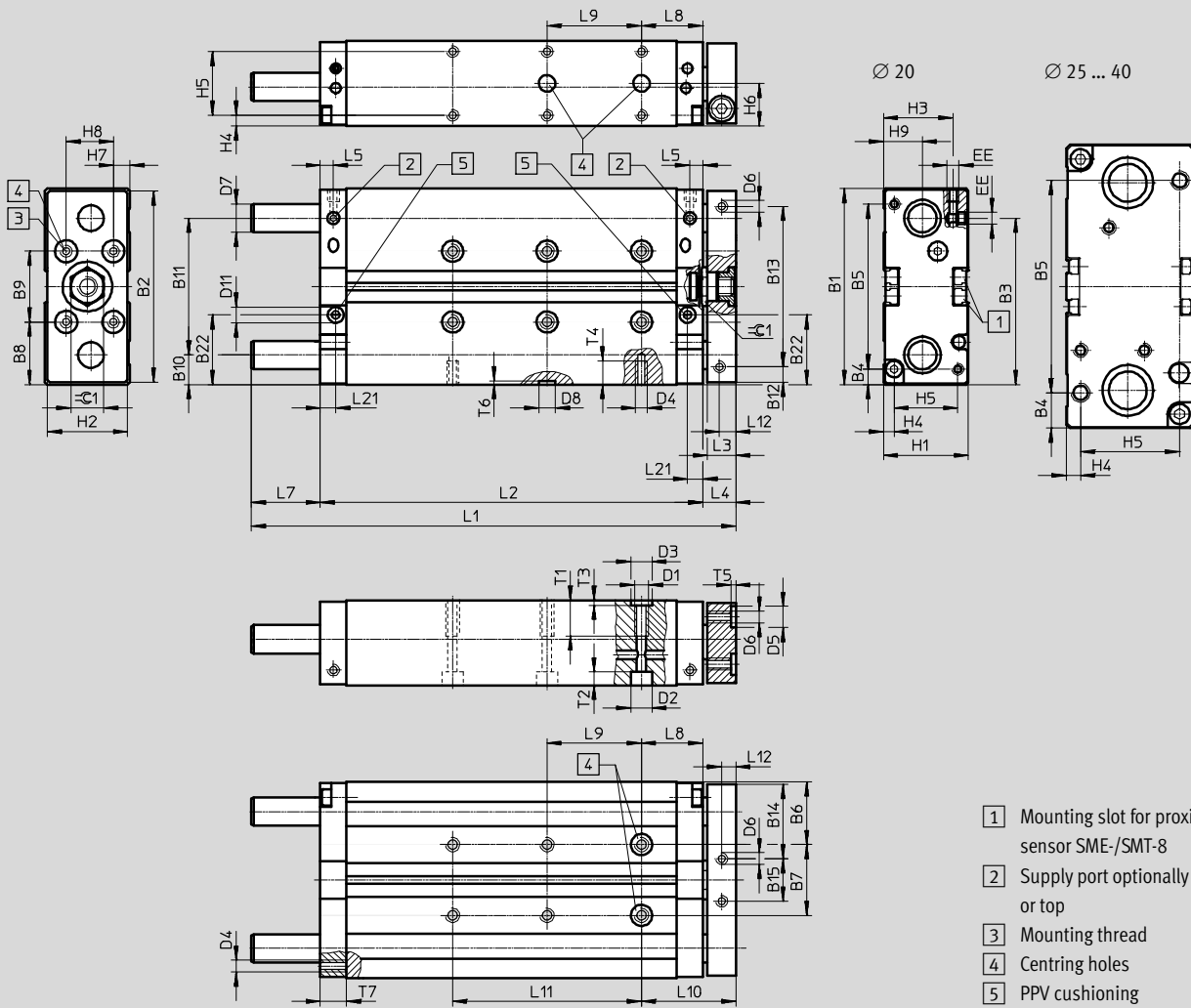

- 1 Mounting slot for proximity sensor SME-/SMT-8
- 2 Supply port optionally at side or top
- 3 Mounting thread
- 4 Centring holes
- 5 PPV cushioning

Guided drives DFM-B

Technical data

∅	B1	B2	B3	B4	B5	B6	B7	B8	B9	B10	B11	B12	B13	B14	B15	B22	D1
[mm]							±0.02 ¹⁾		±0.02 ¹⁾								
20	83	81	70.5	6.5	70	26.5	30	26.5	30	12.5	58	6.5	68	31.5	18	29.5	M6
25	95	93	67	15.5	64	30	35	27.5	40	13.5	68	12.5	68	32.5	28	33.5	M6
32	110	108	77	20	70	33.5	43	35	40	16	78	15	78	41	26	41	M8
40	120	118	86	15	90	34.5	51	35	50	16	88	15	88	41	36	41	M8

1) Tolerance between centring holes

∅	D2 ∅	D3 ∅ H7	D4	D5 ∅ H7	D6 ∅	D7 ∅		D8 ∅ H7	D11 ∅	EE	H1	H2	H3	H4	H5	H6	H7
						GF	KF										
20	9	9	M5	9	M5	14	12	7	6	M5	36	34	29.5	4.5	27	18	7
25	9	9	M6	9	M6	16	14	7	8	G1/8	44	42	34.8	4.5	35	22	12
32	11	12	M6	9	M6	20	16	9	8	G1/8	49	47	39	6	37	24.5	8.5
40	11	12	M8	9	M6	20	16	9	8	G1/8	54	52	41.5	6	42	27	10

∅	H8	H9	L3	L4	L5	L8	L10	L12	L21	T1	T2	T3	T4	T5	T6	T7	⊕C1
[mm]																	
20	20	16.5	12	14	5.5	26	40	6	6.5	12	5.7	2.1	10	2.1	1.6	11	14
25	20	19	12	14	8.5	26	40	6	10	15	5.7	2.1	12	2.1	1.6	15	17
32	30	21	14	16	8.5	29	45	7	10	20	6.8	2.6	11	2.1	2.1	15	17
40	30	26	14	16	8.5	29	45	7	10	20	6.8	2.6	16	2.1	2.1	15	17

Stroke [mm]	Piston ∅ [mm]																			
	20					25					32					40				
	L1	L2	L7	L9 ±0.02 ¹⁾	L11	L1	L2	L7	L9 ±0.02 ¹⁾	L11	L1	L2	L7	L9 ±0.02 ¹⁾	L11	L1	L2	L7	L9 ±0.02 ¹⁾	L11
20	105	82	9	20	-	111	90	7	20	-	118	95	7	20	-	-	-	-	-	-
25	110	87	9	20	-	116	95	7	20	-	123	100	7	20	-	123	101	6	20	-
30	115	92	9	20	-	121	100	7	20	-	133	105	12	20	-	-	-	-	-	-
40	135	102	19	20	-	141	110	17	20	-	143	115	12	20	-	-	-	-	-	-
50	145	112	19	40	-	151	120	17	40	-	153	125	12	40	-	153	126	11	40	-
80	185	142	29	40	-	196	150	32	40	-	208	155	37	40	-	208	156	36	40	-
100	205	162	29	40	80	216	170	32	40	80	228	175	37	40	80	228	176	36	40	80
125	257	187	56	40	80	271	195	62	40	80	283	200	67	40	80	283	201	66	40	80
160	292	222	56	40	120	306	230	62	40	120	318	235	67	40	120	318	236	66	40	120
200	332	262	56	40	160	346	270	62	40	160	358	275	67	40	160	358	276	66	40	160
250	472	312	146	40	200	476	320	142	40	200	483	325	142	40	200	483	326	141	40	200
320	542	382	146	40	240	546	390	142	40	240	553	395	142	40	240	553	396	141	40	240
400	622	462	146	40	320	626	470	142	40	320	633	475	142	40	320	633	476	141	40	320

1) Tolerance between centring holes

⊕ - Note: This product conforms to ISO 1179-1 and to ISO 228-1

Note

If the guide rods project beyond the housing when the unit is in its retracted end position (→ dimension L7), a recess must be provided in the

mounting surface if the unit is to be mounted against a surface in order to allow the guide rods to move freely.

When using a variable stroke, the dimensions L1, L2, L7, L9 and L11 correspond to the next longest standard stroke.

Guided drives DFM-B

Technical data

Dimensions

Download CAD data → www.festo.com

YSRW – Self-adjusting cushioning

∅ 20 ... 40 mm

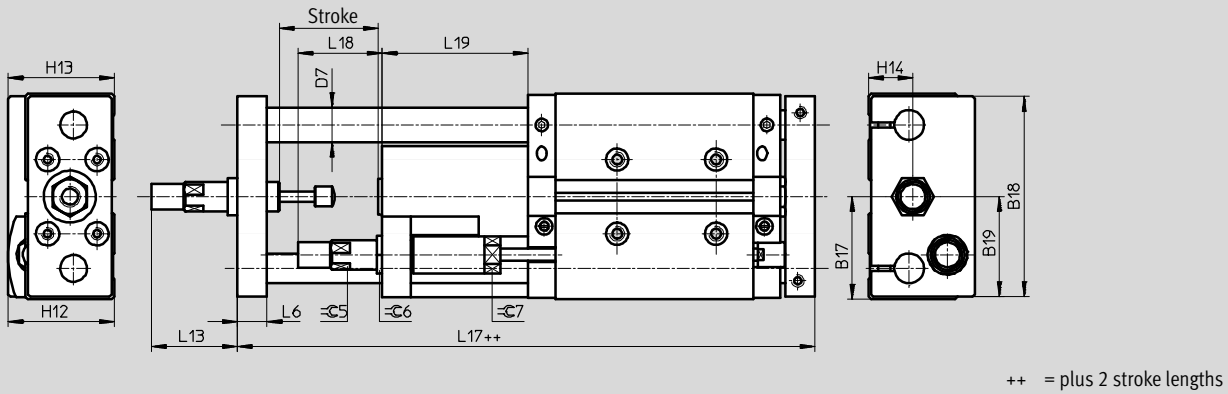

AJ/EJ – Precision stroke adjustment, advanced end position and retracted end position

∅ 20 ... 40 mm

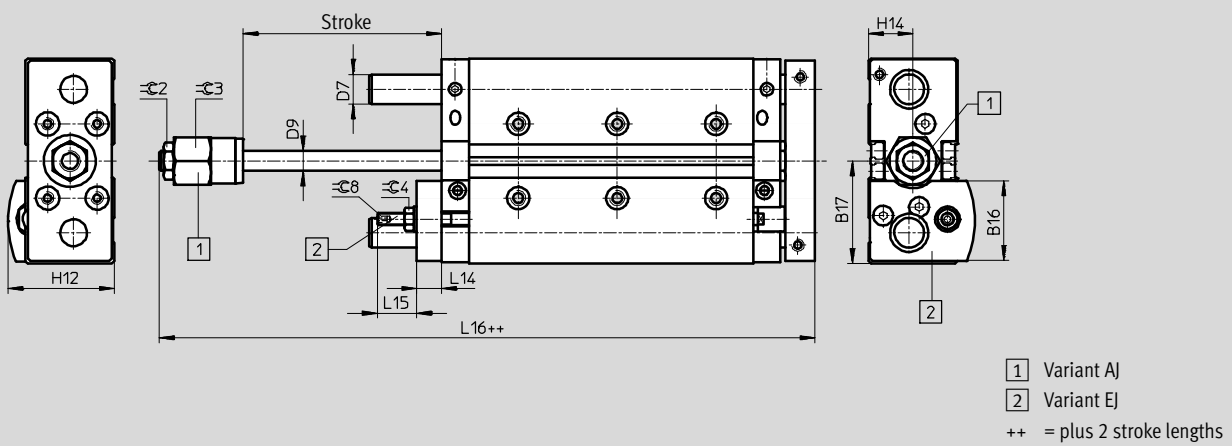

Guided drives DFM-B

Technical data

∅ [mm]	B16	B17	B18	B19	D7 ∅		D9 ∅	H12	H13	H14	L6	L13	L14
					GF	KF							
20	32.5	41.5	81	40.5	14	12	8	43	43	18	12	36.5	10
25	38.6	47.5	90	45	16	14	10	49.5	50.5	22	14	43	12
32	43.4	55	105	52.5	20	16	12	56.5	56	24.5	16	52	12
40	46.2	60	116	58	20	16	12	62.5	63.5	27	16	72	12

∅ [mm]	L15	L16	L17	L18	L19	≈C2	≈C3	≈C4	≈C5	≈C6	≈C7	≈C8
20	16	110	153.5	34	59	13	19	8	11	15	13	2.5
25	23.5	119.5	176.5	37.5	71	17	24	13	13	17	16	4
32	18.5	129.5	190.5	48.5	76	17	30	13	15	17	19	4
40	18.5	132	209.5	55.5	95	17	30	13	20	22	27	4

Guided drives DFM-B

Technical data

FESTO

Dimensions

Piston \varnothing 50 ... 63 mm

Download CAD data → www.festo.com

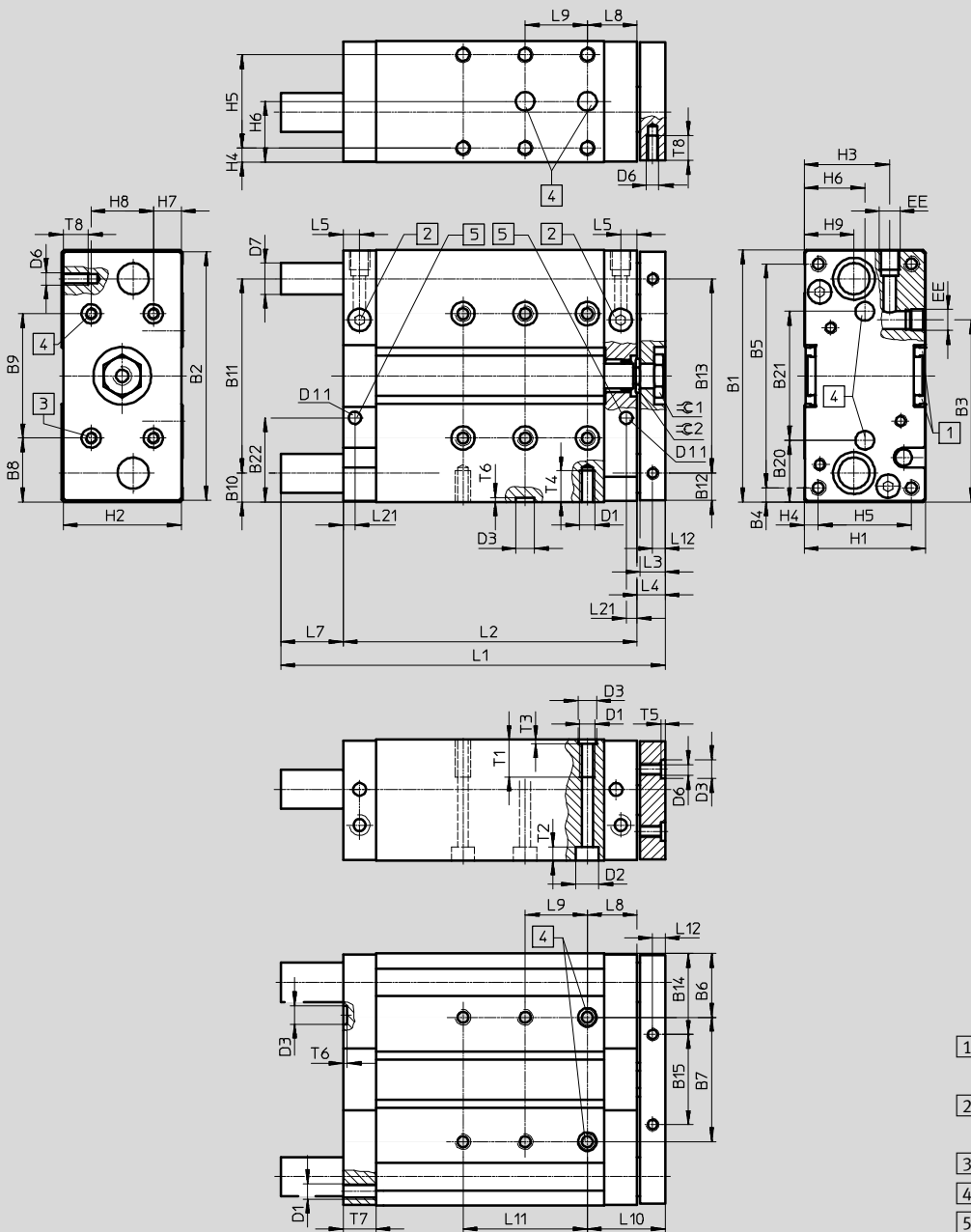

- 1 Mounting slot for proximity sensors
- 2 Supply port optionally at side or top
- 3 Mounting thread
- 4 Centring holes
- 5 PPV cushioning

Guided drives DFM-B

Technical data

∅	B1	B2	B3	B4	B5	B6	B7	B8	B9	B10	B11	B12	B13	B14	B15	B20	B21
[mm]							±0.02 ¹⁾		±0.02 ¹⁾								±0.02 ¹⁾
50	148	146	104.5	19	110	42	64	44	60	19	110	18	110	52	42	40	68
63	162	160	117	9	144	41	80	41	80	18.5	125	17.5	125	51	58	39.5	83

∅	B22	D1	D2	D3	D6	D7		D11	EE	H1	H2	H3	H4	H5	H6	H7	H8
[mm]			∅	∅	∅	∅	∅	∅									
			H7	H7		GF	KF										
50	52.5	M8	11	12	M8	25	20	8	G ³ / ₄	64	62	48.5	7	50	32	12	40
63	54	M10	15	12	M8	25	20	8	G ³ / ₄	78	76	55	9	60	39	19	40

∅	H9	L3	L4	L5	L8	L10	L12	L21	T1	T2	T3	T4	T5	T6	T7	T8	≈C1	≈C2
[mm]																		
50	29	16	18	10.5	32	50	8	13.5	20	6.8	2.6	16	2.6	2.6	21	16	24	19
63	32	16	18	10.5	32	50	8	13.5	24	9	2.6	20	2.6	2.6	21	16	24	19

Stroke	Piston ∅ [mm]										
	50					63					
[mm]	L1	L2	L7	L9	L11	L1	L2	L7	L9	L11	
				±0.02 ¹⁾					±0.02 ¹⁾		
25	137	113	6	20	-	137	114	5	20	-	
50	177	138	21	40	80	177	139	20	40	80	
80	227	168	41			227	169	61			40
100	247	188				62	247				
125	293	213	293				214				
160	328	248	139	120	328	249	138	40	120		
200	368	288		160	368	289				200	
250	495	338		200	495	339					
320	565	408	240	565	409	320	320				
400	645	488	320	645	489						

1) Tolerance between centring holes
 - | - Note: This product conforms to ISO 1179-1 and to ISO 228-1

Note

Since the guide rods project beyond the housing when the unit is in its retracted end position (→ dimension L7), a recess must be provided in the mounting surface if the unit is to be mounted against a surface in order to allow the guide rods to move freely.

When using a variable stroke, the dimensions L1, L2, L7, L9 and L11 correspond to the next longest standard stroke.

Guided drives DFM-B

Technical data



Dimensions

Download CAD data → www.festo.com

YSRW – Self-adjusting cushioning

∅ 50 ... 63 mm

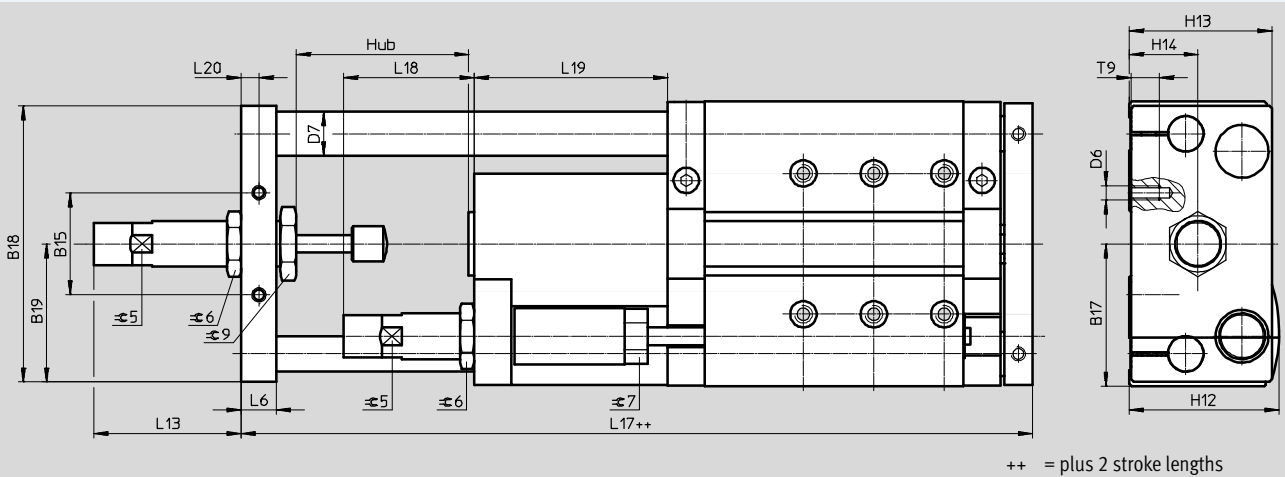

AJ/EJ – Precision stroke adjustment, advanced end position and retracted end position

∅ 50 ... 63 mm

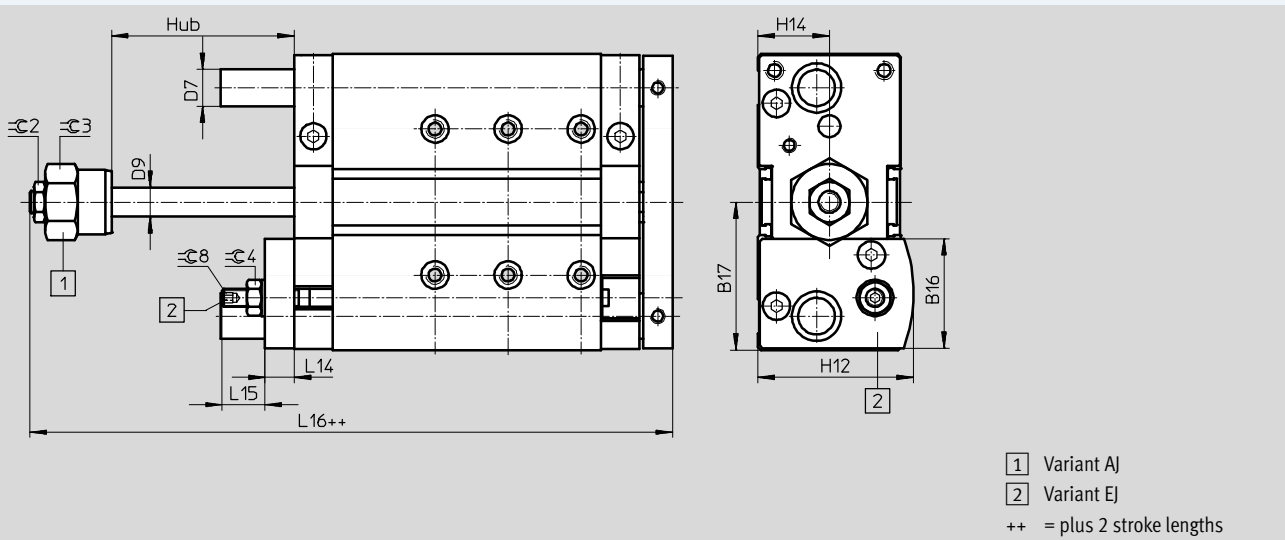

Guided drives DFM-B

Technical data

∅	B15	B16	B17	B18	B19	D6	D7 ∅		D9 ∅	H12	H13	H14	L6	L13	L14
[mm]							GF	KF							
50	42	57.6	74	144	72	M8	25	20	16	74	71	32	16	67.6	16
63	58	60	81	157	78.5	M8	25	20	16	81	81	39	20	83.3	16

∅	L15	L16	L17	L18	L19	L20	T9	≈C2	≈C3	≈C4	≈C5	≈C6	≈C7	≈C8	≈C9
[mm]															
50	24.5	152.1	226.4	58.5	93	8	16	19	36	17	20	27	22	5	30
63	23.5	151.8	249.2	74	110	10	16	19	36	17	24	32	27	5	36

Guided drives DFM-B, with plain-bearing guide GF

Ordering data – Modular products

Ordering table											
Size	12	16	20	25	32	40	50	63	Condi- tions	Code	Enter code
M Module No.	529 119	529 120	532 316	532 317	532 318	532 319	534 769	534 770			
Design	Guided drive									DFM	DFM
Size	12	16	20	25	32	40	50	63		-...	
Stroke [mm]	10	10	-	-	-	-	-	-		-...	
	20	20	20	20	20	-	-	-		-...	
	25	25	25	25	25	25	25	25		-...	
	30	30	30	30	30	-	-	-		-...	
	40	40	40	40	40	-	-	-		-...	
	50	50	50	50	50	50	50	50		-...	
	80	80	80	80	80	80	80	80		-...	
	100	100	100	100	100	100	100	100		-...	
	125	125	125	125	125	125	125	125		-...	
	160	160	160	160	160	160	160	160		-...	
	200	200	200	200	200	200	200	200		-...	
		-	-	250	250	250	250	250	250		-...
	-	-	320	320	320	320	320	320		-...	
	-	-	400	400	400	400	400	400		-...	
Variable stroke [mm]	10 ... 200		20 ... 400			25 ... 400			1	-...	
Generation	B series									-B	-B
Cushioning	Flexible cushioning rings/plates at both ends									-P	
	- Pneumatic cushioning adjustable at both ends									2	-PPV
Position sensing	For proximity sensing									-A	-A
Guide	Plain-bearing guide									-GF	-GF

1 ... Not in combination with precision adjustment A)

2 **PPV** Not in combination with precision adjustment A), E)

M Mandatory data

O Options

Transfer order code

DFM - - - **B** - - **A** - - **GF**

Guided drives DFM-B, with plain-bearing guide GF

Ordering data – Modular products

Ordering table											
Size	12	16	20	25	32	40	50	63	Condi- tions	Code	Enter code
O Temperature-resistant	Heat-resistant seals up to max. 120 °C								3	S6	
Precision adjustment in the end positions, advanced	Precision adjustment advanced									-AJ	
Precision adjustment in the end positions, retracted	-	-	Precision adjustment retracted							-EJ	
Accessories	Supplied separately									ZUB-	ZUB-
Slot cover for sensor slot	1 ... 10									...S	
Proximity sensor	With cable 2.5 m									...G	
	Contactless with cable 2.5 m									...I	

3 **S6** Not in combination with precision adjustment AJ, EJ

- M** Mandatory data
- O** Options

Transfer order code

- - - **ZUB** -

Guided drives DFM-B, with recirculating ball bearing guide KF

Ordering data – Modular products

Ordering table												
Size	12	16	20	25	32	40	50	63	Condi- tions	Code	Enter code	
M Module No.	529 119	529 120	532 316	532 317	532 318	532 319	534 769	534 770				
Design	Guided drive									DFM	DFM	
Size	12	16	20	25	32	40	50	63		-...		
Stroke [mm]	10	10	-	-	-	-	-	-		-...		
	20	20	20	20	20	-	-	-		-...		
	25	25	25	25	25	25	25	25		-...		
	30	30	30	30	30	-	-	-		-...		
	40	40	40	40	40	-	-	-		-...		
	50	50	50	50	50	50	50	50		-...		
	80	80	80	80	80	80	80	80		-...		
	100	100	100	100	100	100	100	100		-...		
	125	125	125	125	125	125	125	125		-...		
	160	160	160	160	160	160	160	160		-...		
	200	200	200	200	200	200	200	200		-...		
		-	-	250	250	250	250	250	250		-...	
	-	-	320	320	320	320	320	320		-...		
	-	-	400	400	400	400	400	400		-...		
Variable stroke [mm]	10 ... 200		20 ... 400			25 ... 400			[1]	-...		
Generation	B series									-B	-B	
Cushioning	Flexible cushioning rings/plates at both ends									-P		
	-	Pneumatic cushioning adjustable at both ends								[2]	-PPV	
	-	Shock absorber with progressive cushioning								[3]	-YSRW	
Position sensing	For proximity sensing									-A	-A	
Guide	Recirculating ball bearing guide									-KF	-KF	

[1] ... Not in combination with precision adjustment A), cushioning YSRW
 [2] **PPV** Not in combination with precision adjustment A), E)

[3] **YSRW** Not with precision adjustment A), E), since already integrated

- M** Mandatory data
- O** Options

Transfer order code

DFM - - - **B** - - **A** - - **KF**

Guided drives DFM-B, with recirculating ball bearing guide KF

Ordering data – Modular products

Ordering table											
Size	12	16	20	25	32	40	50	63	Condi- tions	Code	Enter code
O Precision adjustment in the end positions, advanced	Precision adjustment advanced									-AJ	
Precision adjustment in the end positions, retracted	-	-	Precision adjustment retracted							-EJ	
Accessories	Supplied separately									ZUB-	ZUB-
Slot cover for sensor slot	1 ... 10									...S	
Proximity sensor	With cable 2.5 m		1 ... 10							...G	
	Contactless with cable 2.5 m		1 ... 10							...I	

- M** Mandatory data
- O** Options

Transfer order code

- - **ZUB** -

Guided drives DFM/DFM-B

Accessories



Centring sleeve ZBH

Material:
High-alloy steel

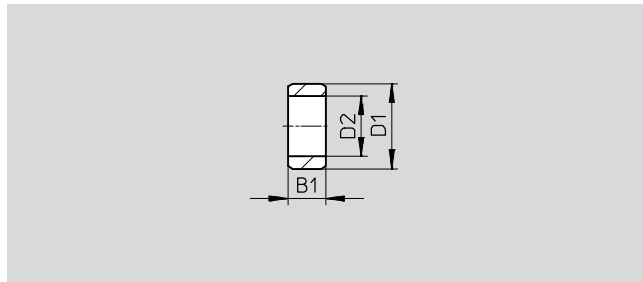

Dimensions and ordering data (repeat order)							
B1	D1	D2	CRC ¹⁾	Weight	Part No.	Type	PU ²⁾
-0.2	∅ h7	∅		[g]			
2.4	5	3.2	2	1	189652	ZBH-5	10
3	7	5.3	2	1	186717	ZBH-7	10
4	9	6.4	2	1	150927	ZBH-9	10
5	12	10.3	2	1	189653	ZBH-12	10
6	15	12.4	2	1	191409	ZBH-15	10

- 1) Corrosion resistance class CRC 2 to Festo standard FN 940070
Moderate corrosion stress. Indoor applications in which condensation may occur. External visible parts with primarily decorative requirements for the surface and which are in direct contact with the ambient atmosphere typical for industrial applications.

- 2) Packaging unit quantity

Centring sleeves included in scope of delivery			
DFM	Piston ∅ [mm]	Centring sleeves	
		for housing	for yoke plate
	12	2x ZBH-5, 2x ZBH-9	2x ZBH-5
	16	2x ZBH-5, 2x ZBH-9	2x ZBH-5
	20	2x ZBH-7, 2x ZBH-9	2x ZBH-9
	25	2x ZBH-7, 2x ZBH-9	2x ZBH-9
	32	2x ZBH-9, 2x ZBH-12	2x ZBH-9
	40	2x ZBH-9, 2x ZBH-12	2x ZBH-9
	50	2x ZBH-12	2x ZBH-12
	63	2x ZBH-12	2x ZBH-12
	80	2x ZBH-12	2x ZBH-12
	100	2x ZBH-15	2x ZBH-15

Centring sleeves included in scope of delivery			
DFM-B	Piston ∅ [mm]	Centring sleeves	
		for housing	for yoke plate
	12	2x ZBH-5, 2x ZBH-9	2x ZBH-5
	16	2x ZBH-5, 2x ZBH-9	2x ZBH-5
	20	2x ZBH-7, 2x ZBH-9	2x ZBH-9
	25	2x ZBH-7, 2x ZBH-9	2x ZBH-9
	32	2x ZBH-9, 2x ZBH-12	2x ZBH-9
	40	2x ZBH-9, 2x ZBH-12	2x ZBH-9
	50	2x ZBH-12	2x ZBH-12
	63	2x ZBH-12	2x ZBH-12
	-	-	-
	-	-	-

Guided drives DFM/DFM-B

Accessories

FESTO

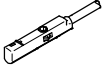

Proximity sensors for piston $\varnothing 12$ with DFM-B

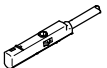
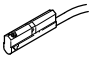
Ordering data – Proximity sensors for C-slot, magneto-resistive						Technical data → Internet: smt
	Type of mounting	Switch output	Electrical connection, connection direction	Cable length [m]	Part No.	Type
N/O contact						
	Insertable in the slot from above	PNP	Cable, 3-wire, in-line	2.5	★ 551373	SMT-10M-PS-24V-E-2,5-L-OE
			Plug M8x1, 3-pin, in-line	0.3	★ 551375	SMT-10M-PS-24V-E-0,3-L-M8D
			Plug M8x1, 3-pin, angled	0.3	551376	SMT-10M-PS-24V-E-0,3-Q-M8D

Ordering data – Proximity sensors for C-slot, magnetic reed						Technical data → Internet: sme
	Type of mounting	Switch output	Electrical connection, connection direction	Cable length [m]	Part No.	Type
N/O contact						
	Insertable in the slot from above	Contacting	Plug M8x1, 3-pin, in-line	0.3	★ 551367	SME-10M-DS-24V-E-0,3-L-M8D
			Cable, 3-wire, in-line	2.5	★ 551365	SME-10M-DS-24V-E-2,5-L-OE
			Cable, 2-wire, in-line	2.5	★ 551369	SME-10M-ZS-24V-E-2,5-L-OE
	Insertable in the slot from above	Contacting	Plug M8x1, 3-pin, in-line	0.3	173212	SME-10-SL-LED-24
			Cable, 3-wire, in-line	2.5	173210	SME-10-KL-LED-24

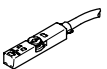
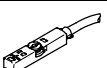
Proximity sensors for piston $\varnothing 12 \dots 100$

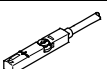
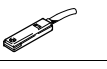

Ordering data – Proximity sensors for T-slot, magneto-resistive						Technical data → Internet: smt
	Type of mounting	Switch output	Electrical connection	Cable length [m]	Part No.	Type
N/O contact						
	Insertable in the slot from above, flush with cylinder profile, short design	PNP	Cable, 3-wire	2.5	★ 574335	SMT-8M-A-PS-24V-E-2,5-OE
			Plug M8x1, 3-pin	0.3	★ 574334	SMT-8M-A-PS-24V-E-0,3-M8D
			Plug M12x1, 3-pin	0.3	★ 574337	SMT-8M-A-PS-24V-E-0,3-M12
		NPN	Cable, 3-wire	2.5	★ 574338	SMT-8M-A-NS-24V-E-2,5-OE
			Plug M8x1, 3-pin	0.3	★ 574339	SMT-8M-A-NS-24V-E-0,3-M8D
N/C contact						
	Insertable in the slot from above, flush with cylinder profile, short design	PNP	Cable, 3-wire	7.5	★ 574340	SMT-8M-A-PO-24V-E-7,5-OE

Ordering data – Proximity sensors for T-slot, magnetic reed						Technical data → Internet: sme
	Type of mounting	Switch output	Electrical connection	Cable length [m]	Part No.	Type
N/O contact						
	Insertable in the slot from above, flush with cylinder profile	Contacting	Cable, 3-wire	2.5	★ 543862	SME-8M-DS-24V-K-2,5-OE
				5.0	★ 543863	SME-8M-DS-24V-K-5,0-OE
			Cable, 2-wire	2.5	★ 543872	SME-8M-ZS-24V-K-2,5-OE
			Plug M8x1, 3-pin	0.3	★ 543861	SME-8M-DS-24V-K-0,3-M8D
	Insertable in the slot lengthwise, flush with the cylinder profile	Contacting	Cable, 3-wire	2.5	150855	SME-8-K-LED-24
			Plug M8x1, 3-pin	0.3	150857	SME-8-S-LED-24
N/C contact						
	Insertable in the slot lengthwise, flush with the cylinder profile	Contacting	Cable, 3-wire	7.5	160251	SME-8-O-K-LED-24

Guided drives DFM/DFM-B

Accessories

FESTO

Ordering data – Connecting cable				Technical data → Internet: nebu	
	Electrical connection, left	Electrical connection, right	Cable length [m]	Part No.	Type
	Straight socket, M8x1, 3-pin	Cable, open end, 3-wire	2.5	★ 541333	NEBU-M8G3-K-2.5-LE3
			5	★ 541334	NEBU-M8G3-K-5-LE3
	Straight socket, M12x1, 5-pin	Cable, open end, 3-wire	2.5	★ 541363	NEBU-M12G5-K-2.5-LE3
			5	★ 541364	NEBU-M12G5-K-5-LE3
	Angled socket, M8x1, 3-pin	Cable, open end, 3-wire	2.5	★ 541338	NEBU-M8W3-K-2.5-LE3
			5	★ 541341	NEBU-M8W3-K-5-LE3
	Angled socket, M12x1, 5-pin	Cable, open end, 3-wire	2.5	541367	NEBU-M12W5-K-2.5-LE3
			5	541370	NEBU-M12W5-K-5-LE3

Ordering data – Slot cover for T-slot			
	Assembly	Length	Part No. Type
	Insertable from above	2x 0.5 m	151680 ABP-5-S

Ordering data – One-way flow control valves			Technical data → Internet: grla		
	Connection		Material	Part No.	Type
	Thread	For tubing O.D.			
	M5	3	Metal design	★ 193137	GRLA-M5-QS-3-D
		4		★ 193138	GRLA-M5-QS-4-D
		6		★ 193139	GRLA-M5-QS-6-D
	G1/8	3		★ 193142	GRLA-1/8-QS-3-D
		4		★ 193143	GRLA-1/8-QS-4-D
		6		★ 193144	GRLA-1/8-QS-6-D
		8		★ 193145	GRLA-1/8-QS-8-D
	G1/4	6		★ 193146	GRLA-1/4-QS-6-D
		8		★ 193147	GRLA-1/4-QS-8-D
		10		★ 193148	GRLA-1/4-QS-10-D
	G3/8	6		★ 193149	GRLA-3/8-QS-6-D
		8		★ 193150	GRLA-3/8-QS-8-D
		10		★ 193151	GRLA-3/8-QS-10-D

Guided drives DFM/DFM-B

Accessories

Adapter kit
DHAA, HAPB

Material:
Wrought aluminium alloy
Free of copper and PTFE
RoHS-compliant

 Note
The kit includes the individual mounting interface as well as the necessary mounting material.

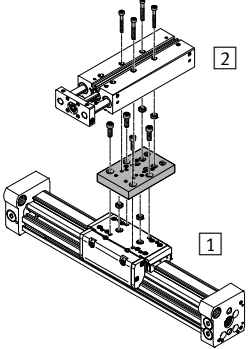
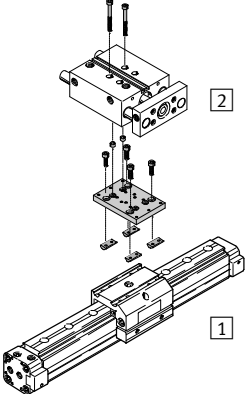
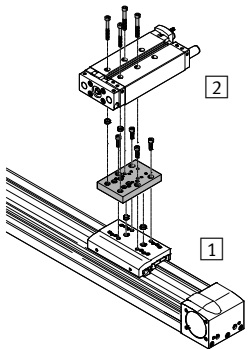
Permissible drive/drive combinations with adapter kit				Download CAD data → www.festo.com		
Combination	[1] Drive	[2] Drive	Adapter kit			
	Size	Size	CRC ¹⁾	Part No.	Type	
DGC/DFM	DGC	DFM	DHAA			
	25	12, 16, 20	2	562152	DHAA-D-L-25-G7-12	
	32	20, 25		562153	DHAA-D-L-32-G7-20	
	40	25, 32, 40		562154	DHAA-D-L-40-G7-25	
DGPL, DGE/DFM	DG...	DFM	HAPB			
	25	12, 16	2	192690	HAPB-12/16	
	32 ²⁾	20, 25		192691	HAPB-20/25	
	40	32, 40		192692	HAPB-32/40	
EGC/DFM	EGC	DFM	DHAA			
	80	12, 16, 20	2	562152	DHAA-D-L-25-G7-12	
	120	25, 32, 40		562154	DHAA-D-L-40-G7-25	

1) Corrosion resistance class CRC 2 to Festo standard FN 940070
Moderate corrosion stress. Indoor applications in which condensation may occur. External visible parts with primarily decorative requirements for the surface and which are in direct contact with the ambient atmosphere typical for industrial applications.

2) Only for DGPL