









Semiconductor Fuses

 European Fuses

DIN 00 Fuses

6,9 gRB-URB - 6 URB

690 V ~
gRB-URB from 16 to 450 A
Size: 00

-  EXTREMELY HIGH INTERRUPTING RATING FUSES:
PROTECTION OF POWER SEMICONDUCTORS
AS PER IEC STANDARD 269.1 AND 4
-  690 V VOLTAGE RATING
-  gR CLASS (gRB RATINGS 16 to 160 A) AS PER VDE 636-23
 - CLEARING ALL OVERLOADS
 - IMPROVING SAFETY AND PROTECTION
 - ENABLING SELECTIVE COORDINATION WITH ALL FUSES
-  aR CLASS (URC AND URD RATINGS 16 TO 450 A) ACCORDING TO
VDE 636-23 AND IEC 269.4
-  CONNECTIONS ACCORDING TO
 - DIN 43653/00C 80 AND 110 mm BETWEEN AXES
 - DIN 43620/00 SOLID BLADES
-  WITH AN INDICATING PAWL ACTIVATING A MICROSWITCH IF NEEDED

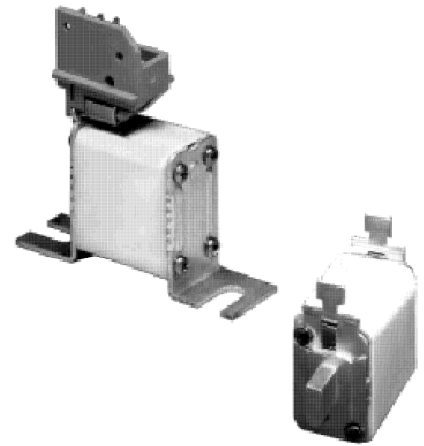

MAIN CHARACTERISTICS

Voltage rating U_N (V)	Class	Current rating I_N (A)	Pre-arcing $I^2t @ 1 \text{ ms}$ I^2t_p (A ² s)	Total clearing $I^2t @ U_N$ I^2t_f (A ² s)	Watts loss		Tested interrupting rating	Estimated interrupting rating
					0.8 I_N	I_N		
690	gRB	16	8	61	2.7	5	200 k A @ 690 V	300 k A @ 690 V
		20	12	86	3.3	6		
		25	18	140	4.4	8		
		32	39	250	6.0	11		
		40	68	450	7.1	13		
		50	116	750	8.8	16		
		63	210	1400	9.9	18		
		80	525	3000	10.5	19		
		100	970	5400	10.7	19.5		
		125	1710	9600	13.2	24		
	160	4270	22400	13.7	25			
	URB	16	7	52	3.8	7	200 k A @ 690 V	300 k A @ 690 V
		20	10	75	5.0	9		
		25	15	120	6.0	11		
		32	32	210	8.2	15		
		40	61	400	9.9	18		
		50	102	700	11.5	21		
		63	177	1200	12.6	23		
		80	390	2200	13.8	25		
		100	692	3900	15.4	28		
125		1170	6600	18.1	33			
160	2680	14 000	19.8	36				
200	4690	24 000	23.1	42				
250	8300	42 500	27.5	50				
315	17 520	81 000	31.9	58				
350 •	25 150	118 000	33.0	60				
400 •	33 200	150 000	38.5	70				
600	URB	450 **	51 850	225 000	40.7	74	200 k A @ 600 V	300 k A @ 600 V

NOTE: voltage rating of 350-400-450 A rated fuses is defined with a CC' curve at 1 second limited by minimum breaking current.

• Voltage rating: 690 V with CC' at 1s - 450 V with CC' at 10 s
 ** Voltage rating: 600 V with CC' at 1s - 450 V with CC' at 10 s

Minimum operating voltage for trip indicator = 20 V



Semiconductor Fuses

European Fuses

DIN 00 Fuses

6,9 gRB-URB - 6 URB

GERMAN STANDARD AS PER DIN 43653/00C - DIN 80 & 110

Current rating	Code	Ref. Number	I/IN Fuse-base
16	6,9 gRB 00 D08L 016	S330273	1
20	6,9 gRB 00 D08L 020	S330227	1
25	6,9 gRB 00 D08L 025	T330228	1
32	6,9 gRB 00 D08L 032	V330229	1
40	6,9 gRB 00 D08L 040	W330230	1
50	6,9 gRB 00 D08L 050	X330231	1
63	6,9 gRB 00 D08L 063	Y330232	1
80	6,9 gRB 00 D08L 080	Z330233	1
100	6,9 gRB 00 D08L 100	A330234	1
125	6,9 gRB 00 D08L 125	B330235	0.9
160	6,9 gRB 00 D08L 160	C330236	0.9

**gRB
DIN 80**

**URB
DIN 80**

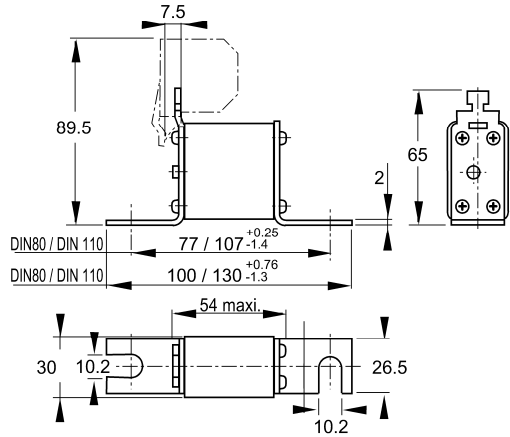

Weight: 140 g(D08) - 190 g(D11)

Packaging: 3 pieces

Microswitches:

6.3 clips		MC 4L 2.5 B6 - Ref. Number: L076646
		or MC 4L 2.5 B6 + PRES - Ref. Number: F210156
2.8 clips		MC 4L 2.5 B2 - Ref. Number: G076642
		or MC 4L 2.5 B2 + PRES - Ref. Number: G210157

Fuse-base: SI 00 DIN 80 - Ref. Number: Q098040

Current rating	Catalog Number	Ref. Number	I/IN Fuse-base
16	6,9 URB 00 D08L 016	V330275	1
20	6,9 URB 00 D08L 020	T330271	1
25	6,9 URB 00 D08L 025	M330268	1
32	6,9 URB 00 D08L 032	N330269	1
40	6,9 URB 00 D08L 040	P330270	1
50	6,9 URB 00 D08L 050	Q330271	1
63	6,9 URB 00 D08L 063	K330272	1
80	6,9 URB 00 D08L 080	D330237	1
100	6,9 URB 00 D08L 100	E330238	1
125	6,9 URB 00 D08L 125	F330239	0.9
160	6,9 URB 00 D08L 160	G330240	0.85
200	6,9 URB 00 D08L 200	H330241	0.85
250	6,9 URB 00 D08L 250	J330242	0.80
315	6,9 URB 00 D08L 315	K330243	0.75
350	6,9 URB 00 D08L 350	L330244	0.75
400	6,9 URB 00 D08L 400	M330245	0.70
450	6 URB 00 D08L 450	N330246	0.65

**gRB
DIN 110**

Current rating	Catalog Number	Ref. Number	I/IN Fuse-base
16	6,9 gRB 00 D11L 016	W330276	1
20	6,9 gRB 00 D11L 020	P330247	1
25	6,9 gRB 00 D11L 025	Q330248	1
32	6,9 gRB 00 D11L 032	R330249	1
40	6,9 gRB 00 D11L 040	S330250	1
50	6,9 gRB 00 D11L 050	T330251	1
63	6,9 gRB 00 D11L 063	V330252	1
80	6,9 gRB 00 D11L 080	W330253	1
100	6,9 gRB 00 D11L 100	X330254	1
125	6,9 gRB 00 D11L 125	Y330255	0.9
160	6,9 gRB 00 D11L 160	Z330256	0.9

**URB
DIN 110**

Current rating	Catalog Number	Ref. Number	I/IN Fuse-base
80	6,9 URB 00 D11L 80	A330257	1
100	6,9 URB 00 D11L 100	B330258	1
125	6,9 URB 00 D11L 125	C330259	0.9
160	6,9 URB 00 D11L 160	D330260	0.85
200	6,9 URB 00 D11L 200	E330261	0.85
250	6,9 URB 00 D11L 250	F330262	0.80
315	6,9 URB 00 D11L 315	G330263	0.75
350	6,9 URB 00 D11L 350	H330264	0.75
400	6,9 URB 00 D11L 400	J330265	0.70
450	6 URB 00 D11L 450	K330266	0.65

GERMAN STANDARD AS PER DIN 43620/00

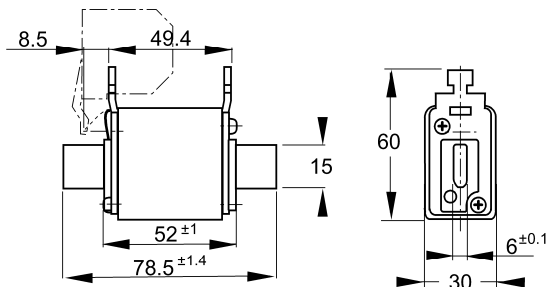

Weight: 210 g

Packaging: 3 pieces

Microswitches:

6.3 clips		MC 4L 2.5 B6 - Ref. Number: L076646
		or MC 4L 2.5 B6 + PRES - Ref. Number: F210156
2.8 clips		MC 4L 2.5 B2 - Ref. Number: G076642
		or MC 4L 2.5 B2 + PRES - Ref. Number: G210157

Fuse-base: 00EP - Ref. Number: F21517

I/IN : Ratio RMS steady current / current rating for fuses in base.

gRB

Current rating	Catalog Number	Ref. Number	I/IN Fuse-base
16	6,9 gRB 00 PV/016	L330267	1
20	6,9 gRB 00 PV/020	W330207	1
25	6,9 gRB 00 PV/025	X330208	1
32	6,9 gRB 00 PV/032	Y330209	1
40	6,9 gRB 00 PV/040	Z330210	1
50	6,9 gRB 00 PV/050	A330211	1
63	6,9 gRB 00 PV/063	B330212	0.90
80	6,9 gRB 00 PV/080	C330213	0.90
100	6,9 gRB 00 PV/100	D330214	0.90
125	6,9 gRB 00 PV/125	E330215	0.85
160	6,9 gRB 00 PV/160	F330216	0.85

URB

Current rating	Catalog Number	Ref. Number	I/IN Fuse-base
80	6,9 URB 00 PV/080	G330217	0.90
100	6,9 URB 00 PV/100	H330218	0.90
125	6,9 URB 00 PV/125	J330219	0.85
160	6,9 URB 00 PV/160	K330220	0.85
200	6,9 URB 00 PV/200	L330221	0.85
250	6,9 URB 00 PV/250	M330222	0.80
315	6,9 URB 00 PV/315	N330223	0.75
350	6,9 URB 00 PV/350	P330224	0.75
400	6,9 URB 00 PV/400	Q330225	0.70
450	6 URB 00 PV/450	R330226	0.65



Semiconductor Fuses

European Fuses

DIN 00 Fuses

6,9 gRB-URB - 6 URB

Total clearing I²t

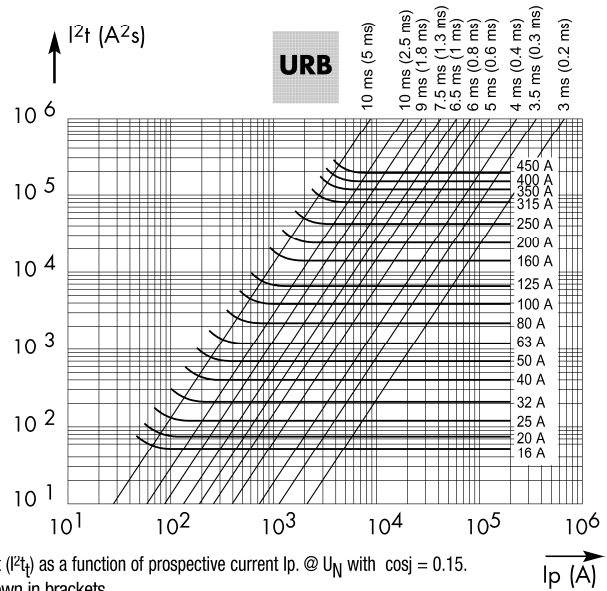
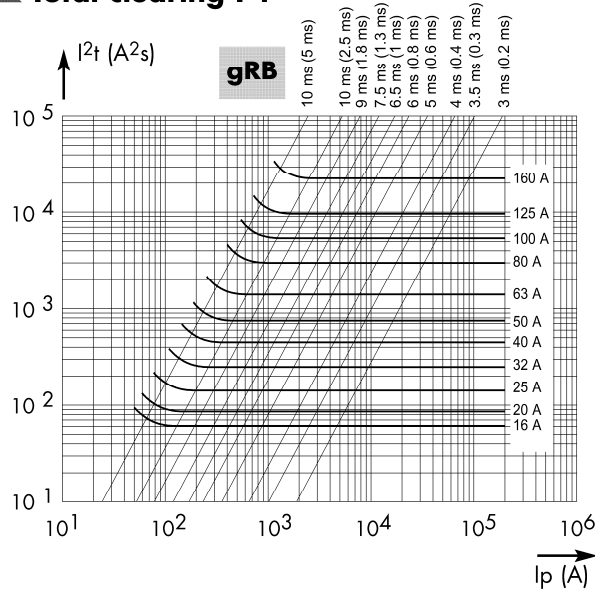

Above: horizontal curves show, for each rated current, maximum values of total clearing I^2t (I^2t_t) as a function of prospective current I_p . @ U_N with $\cos \phi = 0.15$.
 Oblique lines indicate total clearing duration T_t , with associated pre-arcing duration shown in brackets.

I²t corrective factor

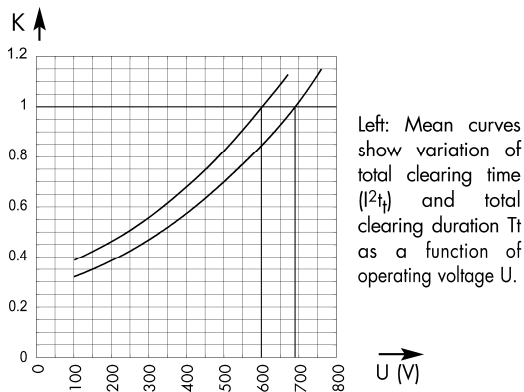

Peak arc voltage

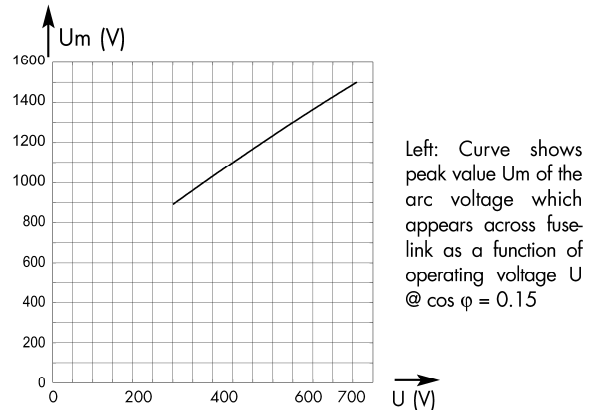

Watts loss

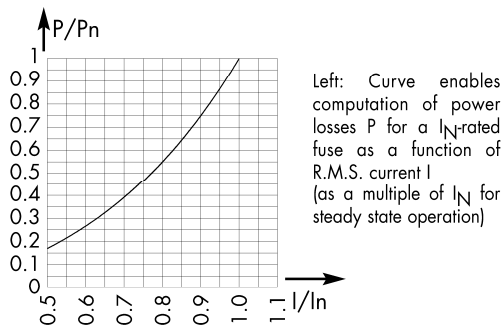



Semiconductor Fuses

European Fuses

DIN 00 Fuses

6,9 gRB-URB - 6 URB

DC Application data

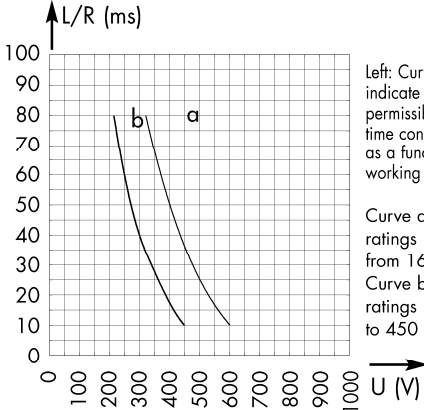

Rated current	Curve	I _{pm} (A)	
		gRB	URB
16	a	32	32
20	a	40	40
25	a	50	50
32	a	64	64
40	a	80	80
50	a	100	100
63	u	126	126
80	a	160	170
100	a	200	220
125	a	250	280
160	a	320	390
200	a		510
250	a		650
315	b		840
350	b		1770
400	b		2040
450	b		2250

I_{pm} values give minimum DC interrupting current in amps.

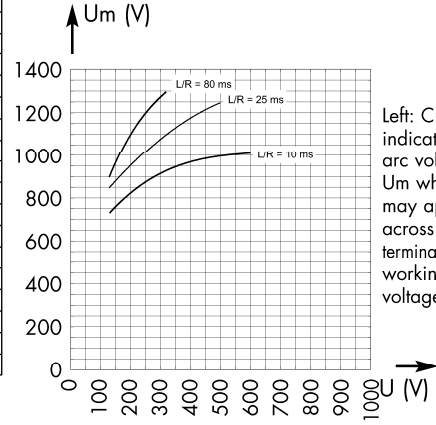

Current limitation curves

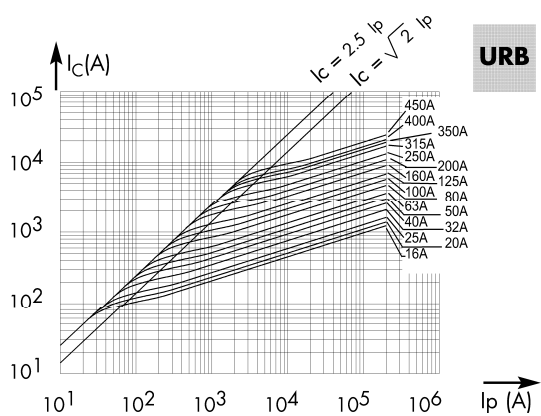
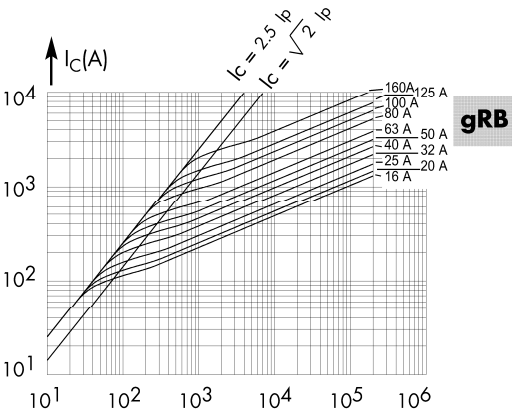

Above: Curves show, for each rating, value of peak let-through current I_c as a function of available fault current I_p.

Time vs current characteristics

