

GNL-3004xx (Φ 3mm ROUND TYPE) Standard Brightness

ABSOLUTE MAXIMUM RATING:(Ta=25°C)

Parameter			Unit
DC Forward Current	30		mA
Reverse Voltage	5		V
Reverse Current (Vr=5V)	10		μA
Peak Forward Current ,tw ,=1 msec Duty ,=1/20	150		mA
Operation Temperature	-40	+80	°C
Storage Temperature	-40	+100	°C
Solder Dip (5 seconds,1.6mm from body) Temperature	300	±5	°C

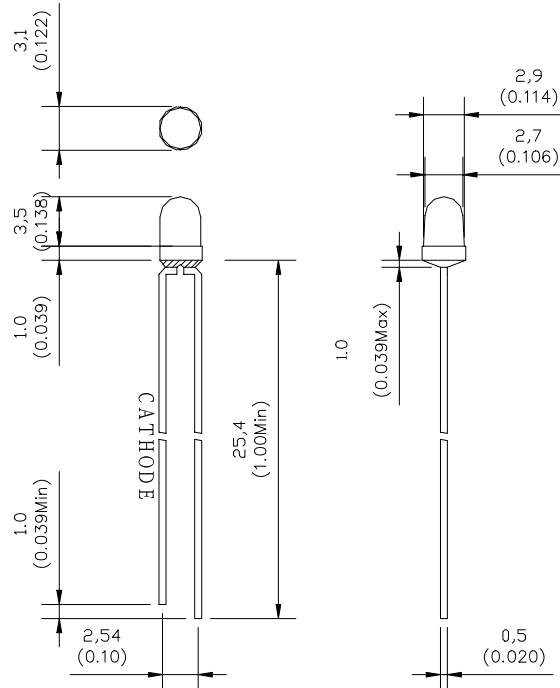

Feature:

- 1.Small flange without stand-off
- 2.Long life-solid state reliability
- 3.Long lead length(25.4mm)
- 4.Versatile mounting on P.C. board or panel

Description:

- 1.The shape of this series is round
- 2.General application is for indication,illumination,etc.
- 3.These LED lamps are available with a choice of defferent colors,light intensities,epoxy colors,etc.

Part Number	EMITTED COLOR		Lens Color	Peak Wavelength (nm)	Vf (v) Typ	IV (If=20mA) mcd		View Angle 2 θ 1/2
						Min.	Max.	
GNL-3004HD	GaP	Red	Red Diffused	700	2.1	0.8	5	60°
GNL-3004GD	GaP	Green	Green Diffused	565	2.1	2.5	15	60°
GNL-3004YD	GaAsP	Yellow	Yellow Diffused	585	2.1	2.5	15	60°
GNL-3004ED	GaAsP/Gap	Orange	Red Diffused	635	2.0	3	20	60°
GNL-3004ED-E	GaAsP/Gap	Orange	Orange Diffused	635	2.0	3	20	60°
GNL-3004HT	Gap	Red	Red Transparent	700	2.1	5	15	20°
GNL-3004GT	Gap	Green	Green Transparent	565	2.1	8	30	20°
GNL-3004YT	GaAsP	Yellow	Yellow Transparent	585	2.1	8	30	20°
GNL-3004ET	GaAsP/Gap	Orange	Red Transparent	635	2.0	12	50	20°
GNL-3004ET-E	GaAsP/Gap	Orange	Orange Transparent	635	2.0	12	50	20°