

FEATURES

- Filterless digital input, mono Class-D amplifier**
- Operates from a single 4.5 V to 17 V supply**
- 31.3 W output power, 17 V supply, and 4 Ω load at 1% THD + N**
- 107 dB A-weighted signal-to-noise ratio**
- 93.3% efficiency into 8 Ω load at 12 V**
- I²C control with up to 4 pin selectable slots/addresses**
- Supports multiple serial data formats up to TDM16**
- Digital interface supports sample rates from 8 kHz to 192 kHz**
- Flexible digital and analog gain adjustment**
- Flexible supply monitoring AGC function**
- 6.55 mA quiescent current with single 17 V PVDD supply**
- Short-circuit and thermal protection, thermal warning**
- 20-ball, 1.8 mm × 2.2 mm, 0.4 mm pitch WLCSP**
- Pop and click suppression**
- User selectable ultralow EMI emissions mode**
- Power-on reset**

APPLICATIONS

- Notebooks**
- Portable electronics**
- Home audio**

GENERAL DESCRIPTION

The **SSM3515** is a fully integrated, high efficiency, mono Class-D audio amplifier with digital inputs. The application circuit requires a minimum of external components and can operate from a single 4.5 V to 17 V supply. It can deliver 8.4 W of output power into an 8 Ω load or 15.8 W into a 4 Ω load from a 12 V power supply, or 31.3 W into an 4 Ω load from a 17 V power supply, all with 1% THD + N.

The **SSM3515** features a high efficiency, low noise modulation scheme that requires no external LC output filters. This scheme provides high efficiency even at low output power. It operates with 92% efficiency at 7 W into an 8 Ω load or 88% efficiency at 15 W into 4 Ω from a 12 V supply.

Spread spectrum pulse density modulation provides lower EMI radiated emissions compared with other Class-D architectures, particularly above 100 MHz.

The digital input eliminates the need for an external digital-to-analog converter (DAC). The **SSM3515** has a micropower shutdown mode with a typical shutdown current of 39 nA at the 12 V PVDD supply. The device also includes pop and click suppression circuitry that minimizes voltage glitches at the output during turn on and turn off.

The **SSM3515** operates with or without an I²C control interface. The **SSM3515** is specified over the commercial temperature range (−40°C to +85°C). It has built in thermal shutdown and output short-circuit protection. It is available in a halide-free, 20-ball, 1.8 mm × 2.2 mm wafer-level chip scale package (WLCSP).

FUNCTIONAL BLOCK DIAGRAM

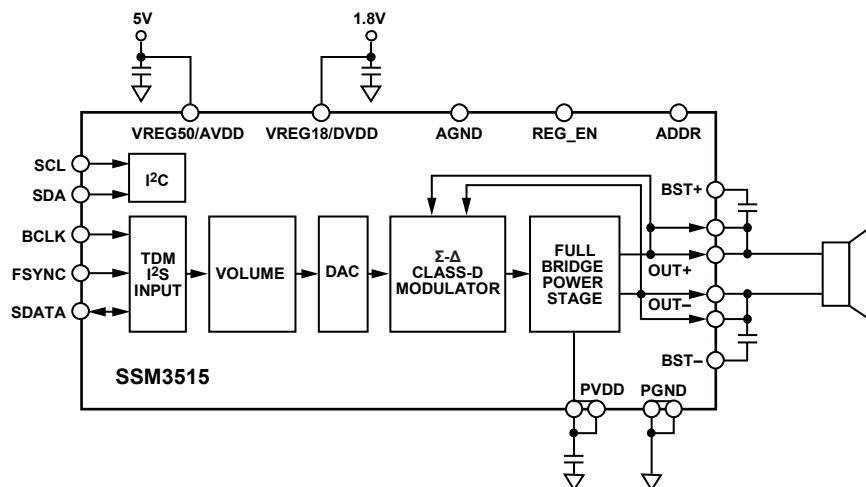

Figure 1.

Rev. A

[Document Feedback](#)

Information furnished by Analog Devices is believed to be accurate and reliable. However, no responsibility is assumed by Analog Devices for its use, nor for any infringements of patents or other rights of third parties that may result from its use. Specifications subject to change without notice. No license is granted by implication or otherwise under any patent or patent rights of Analog Devices. Trademarks and registered trademarks are the property of their respective owners.

One Technology Way, P.O. Box 9106, Norwood, MA 02062-9106, U.S.A.
 Tel: 781.329.4700 ©2015–2017 Analog Devices, Inc. All rights reserved.
[Technical Support](#) www.analog.com

TABLE OF CONTENTS

Features	1	EMI Noise.....	24
Applications.....	1	Output Modulation Description	24
General Description	1	Faults and Limiter Status Reporting	25
Functional Block Diagram	1	VBAT Sensing.....	25
Revision History	2	Limiter and Battery Tracking Threshold Control.....	25
Specifications.....	3	Layout	28
Digital Timing Characteristics	6	Bootstrap Capacitors.....	28
Absolute Maximum Ratings.....	8	Power Supply Decoupling	28
Thermal Resistance	8	Register Summary	29
ESD Caution.....	8	Register Details	30
Pin Configuration and Function Descriptions.....	9	Power Control Register	30
Typical Performance Characteristics	10	Gain and Edge Control Register.....	30
Theory of Operation	19	DAC Control Register.....	31
Overview.....	19	DAC Volume Control Register	32
Power Supplies	19	SAI Control 1 Register.....	33
Power-Up Sequence	19	SAI Control 2 Register.....	34
Power-Down Operation	19	Battery Voltage Output Register.....	35
REG_EN Pin Setup and Control.....	19	Limiter Control 1 Register	35
ADDR Pin Setup and Control	20	Limiter Control 2 Register	36
Clocking.....	20	Limiter Control 3 Register	37
Digital Audio Serial Interface	21	Status Register.....	37
Stereo (I ² S/Left Justified) Operating Mode.....	21	Fault Control Register.....	38
TDM Operating Mode.....	21	Typical Application Circuit	40
I ² C Control	21	Outline Dimensions	41
Analog and Digital Gain.....	24	Ordering Guide	41
Pop and Click Suppression.....	24		

REVISION HISTORY

1/2017—Rev. 0 to Rev. A

Changes to Figure 2 and Table 5..... 6

6/2015—Revision 0: Initial Version

SPECIFICATIONS

$PV_{DD} = 12\text{ V}$, $VREG50/AVDD = 5\text{ V}$ (internal), $VREG18/DVDD = 1.8\text{ V}$ (external), $R_L = 8\ \Omega + 33\ \mu\text{H}$, $BCLK = 3.072\text{ MHz}$ and $FSYNC = 48\text{ kHz}$, $T_A = -40^\circ\text{C}$ to $+85^\circ\text{C}$, unless otherwise noted. The measurements are with a 20 kHz AES17 low-pass filter. The other load impedances used are $4\ \Omega + 15\ \mu\text{H}$ and $3\ \Omega + 10\ \mu\text{H}$. Measurements are with a 20 kHz AES17 low-pass filter, unless otherwise noted.

The sine wave output powers above 20 W in 4 Ω cannot be continuous and may invoke the thermal limit indicator based on the power dissipation capability of the board.

Table 1.

Parameter	Symbol	Test Conditions/Comments	Min	Typ	Max	Unit
DEVICE CHARACTERISTICS						
Output Power/Channel $R_L = 8\ \Omega$	P_{OUT}	$f = 1\text{ kHz}$ THD + N = 1%, $PV_{DD} = 17\text{ V}$ THD + N = 1%, $PV_{DD} = 12\text{ V}$ THD + N = 1%, $PV_{DD} = 7\text{ V}$ THD + N = 1%, $PV_{DD} = 5\text{ V}$ THD + N = 10%, $PV_{DD} = 17\text{ V}$ THD + N = 10%, $PV_{DD} = 12\text{ V}$ THD + N = 10%, $PV_{DD} = 7\text{ V}$ THD + N = 10%, $PV_{DD} = 5\text{ V}$		16 8.4 2.8 1.4		W W W W
$R_L = 4\ \Omega$		THD + N = 10%, $PV_{DD} = 17\text{ V}$ THD + N = 10%, $PV_{DD} = 12\text{ V}$ THD + N = 10%, $PV_{DD} = 7\text{ V}$ THD + N = 10%, $PV_{DD} = 5\text{ V}$ THD + N = 1%, $PV_{DD} = 17\text{ V}$ THD + N = 1%, $PV_{DD} = 12\text{ V}$ THD + N = 1%, $PV_{DD} = 7\text{ V}$ THD + N = 1%, $PV_{DD} = 5\text{ V}$ THD + N = 10%, $PV_{DD} = 17\text{ V}$ THD + N = 10%, $PV_{DD} = 12\text{ V}$ THD + N = 10%, $PV_{DD} = 7\text{ V}$ THD + N = 10%, $PV_{DD} = 5\text{ V}$		19.7 10.5 3.5 1.8 31.3 15.8 5.4 2.8 39.3 19.7 6.7 3.4		W W W W W W W W W W W W W
Efficiency	η	THD + N = 10%, $PV_{DD} = 5\text{ V}$ $P_{OUT} = 9\text{ W}$, $R_L = 8\ \Omega$, $PV_{DD} = 12\text{ V}$ $P_{OUT} = 9\text{ W}$, $R_L = 8\ \Omega$, $PV_{DD} = 12\text{ V}$ (low EMI mode) $P_{OUT} = 30\text{ W}$, $R_L = 4\ \Omega$, $PV_{DD} = 17\text{ V}$ $P_{OUT} = 30\text{ W}$, $R_L = 4\ \Omega$, $PV_{DD} = 17\text{ V}$ (low EMI mode)		93.3 93.2 88 87.8		% % % %
Total Harmonic Distortion + Noise	THD + N	$P_{OUT} = 5\text{ W}$ into $R_L = 8\ \Omega$, $f = 1\text{ kHz}$, $PV_{DD} = 16\text{ V}$		0.004		%
Load Resistance			3			Ω
Load Inductance			5	10		μH
Output FET On Resistance	R_{ON}			110		m Ω
Overcurrent Protection Trip Point	I_{OC}		5.8			A peak
Average Switching Frequency	f_{SW}			300		kHz
Differential Output DC Offset Voltage	V_{OOS}	Gain = 12.6 V		± 1	± 5.0	mV
POWER SUPPLIES						
Supply Voltage Range	PV_{DD} $VREG50/AVDD$ $VREG18/DVDD$	Guaranteed from PSRR test Internal Internal or external	4.5 4.5 1.62		17 5.5 1.98	V V V
AC Power Supply Rejection Ratio	$PSRR_{AC}$	$V_{RIPPLE} = 1\text{ V rms}$ at 1 kHz		87	73	dB
GAIN CONTROL						
Output Voltage Peak		Measured with 0 dBFS input at 1 kHz Analog gain setting = 8.4 V/V with $PV_{DD} = 17\text{ V}$ Analog gain setting = 12.6 V/V with $PV_{DD} = 17\text{ V}$ Analog gain setting = 14.0 V/V with $PV_{DD} = 17\text{ V}$ Analog gain setting = 15.0 V/V with $PV_{DD} = 17\text{ V}$		8.4 12.6 14 15		V peak V peak V peak V peak

Parameter	Symbol	Test Conditions/Comments	Min	Typ	Max	Unit
SHUTDOWN CONTROL¹						
Turn On Time, Volume Ramp Disabled	t_{WU}	Time from SPWDN = 0 to output switching, DAC_HV = 1 or DAC_MUTE = 1, t_{WU} = 4 FSYNC cycles to 7 FSYNC cycles + 7.68 ms				
f_S = 12 kHz			8.01		8.27	ms
f_S = 24 kHz			7.84		7.98	ms
f_S = 48 kHz			7.76		7.83	ms
f_S = 96 kHz			7.72		7.76	ms
f_S = 192 kHz			7.70		7.72	ms
Turn On Time, Volume Ramp Enabled	t_{WUR}	Time from SPWDN = 0 to full volume output switching, DAC_HV = 0 and DAC_MUTE = 0, VOL = 0x40				
f_S = 12 kHz		$t_{WUR} = t_{WU} + 15.83$ ms	23.84		24.10	ms
f_S = 24 kHz		$t_{WUR} = t_{WU} + 15.83$ ms	23.67		23.81	ms
f_S = 48 kHz		$t_{WUR} = t_{WU} + 15.83$ ms	23.59		23.66	ms
f_S = 96 kHz		$t_{WUR} = t_{WU} + 7.92$ ms	15.64		15.68	ms
f_S = 192 kHz		$t_{WUR} = t_{WU} + 0.99$ ms	8.69		8.71	ms
Turn Off Time, Volume Ramp Disabled	t_{SD}	Time from SPWDN = 1 to full power-down, DAC_HV = 1 or DAC_MUTE = 1		100		μ s
Turn Off Time, Volume Ramp Enabled	t_{SDR}	Time from SPWDN = 1 to full power-down, DAC_HV = 0 and DAC_MUTE = 0, VOL = 0x40				
f_S = 12 kHz		$t_{SDR} = t_{SD} + 15.83$ ms		15.932		ms
f_S = 24 kHz		$t_{SDR} = t_{SD} + 15.83$ ms		15.932		ms
f_S = 48 kHz		$t_{SDR} = t_{SD} + 15.83$ ms		15.932		ms
f_S = 96 kHz		$t_{SDR} = t_{SD} + 7.92$ ms		8.016		ms
f_S = 192 kHz		$t_{SDR} = t_{SD} + 0.99$ ms		1.09		ms
Output Impedance	Z_{OUT}		100			k Ω
NOISE PERFORMANCE²						
Output Voltage Noise	e_n	f = 20 Hz to 20 kHz, A-weighted, $PV_{DD} = 12$ V		37.5		μ V rms
		f = 20 Hz to 20 kHz, A-weighted, $PV_{DD} = 17$ V		48		μ V rms
Signal-to-Noise Ratio	SNR	$P_{OUT} = 8.2$ W, $R_L = 8$ Ω , A-weighted, $PV_{DD} = 12$ V		107		dB
		$P_{OUT} = 31$ W, $R_L = 4$ Ω , A-weighted, $PV_{DD} = 17$ V		107		dB
PVDD ADC PERFORMANCE						
PVDD Sense Full-Scale Range		PVDD with full-scale ADC out	3.8		16.2	V
PVDD Sense Absolute Accuracy		$PV_{DD} = 15$ V	-8		+8	LSB
		$PV_{DD} = 5$ V	-6		+6	LSB
Resolution		Unsigned 8-bit output with 3.8 V offset		8		Bits
DIE TEMPERATURE						
Overtemperature Warning				117		$^{\circ}$ C
Overtemperature Protection				145		$^{\circ}$ C

¹ Guaranteed by design.² Noise performance is based on the bench data for $T_A = -40^{\circ}$ C to $+85^{\circ}$ C.

Software master power-down indicates that the clocks are turned off. Auto power-down indicates that there is no dither or zero input signal with clocks on; the device enters soft power-down after 2048 cycles of zero input values. Quiescent indicates triangular dither with zero input signal. All specifications are typical, with a 48 kHz sample rate, unless otherwise noted.

Table 2. Power Supply Current Consumption¹

Edge Rate Control Mode	REG_EN Pin	Test Conditions	No Load				4 Ω + 15 μH				8 Ω + 33 μH				Unit
			I _{PVDD}			I _{REG18}	I _{PVDD}			I _{REG18}	I _{PVDD}			I _{REG18}	
			5 V	12 V	17 V	1.8 V	5 V	12 V	17 V	1.8 V	5 V	12 V	17 V	1.8 V	
Normal	Low	Software master power-down	0.01	0.03	0.03	7	0.01	0.03	0.03	7	0.01	0.03	0.03	7	μA
		Auto power-down	0.01	0.03	0.03	54	0.01	0.03	0.03	54	0.01	0.03	0.03	54	μA
		Quiescent	4.10	5.00	5.60	0.48	4.10	5.12	5.90	0.48	4.10	5.10	5.80	0.48	mA
	PVDD	Software master power-down	0.01	0.03	0.03	N/A	0.01	0.03	0.03	N/A	0.01	0.03	0.03	N/A	μA
		Auto power-down	310	310	316	N/A	310	310	316	N/A	310	310	316	N/A	μA
		Quiescent	4.64	5.60	6.26	N/A	4.74	5.85	6.55	N/A	4.74	5.85	6.55	N/A	mA
Low EMI	Low	Software master power-down	0.01	0.03	0.03	7	0.01	0.03	0.03	7	0.01	0.03	0.03	7	μA
		Auto power-down	0.01	0.03	0.03	54	0.01	0.03	0.03	54	0.01	0.03	0.03	54	μA
		Quiescent	4.00	4.95	5.54	0.48	4.70	3.99	5.59	0.48	4.02	4.98	5.63	0.48	mA
	PVDD	Software master power-down	0.01	0.03	0.03	N/A	0.01	0.03	0.03	N/A	0.01	0.03	0.03	N/A	μA
		Auto power-down	310	310	316	N/A	310	310	316	N/A	310	310	316	N/A	μA
		Quiescent	4.60	5.60	6.17	N/A	4.60	5.65	6.35	N/A	4.60	5.60	6.40	N/A	mA

¹ N/A means not applicable.

Table 3. Power-Down Current

Parameter	Symbol	Test Conditions/Comments	Min	Typ	Max	Unit
POWER-DOWN CURRENT	I _{PVDD}	VREG18/DVDD = 1.8 V external, software master power-down, no BCLK/FSYNC				
		PV _{DD} = 5 V	27	38	95	nA
		PV _{DD} = 12 V	30	39	100	nA
	PV _{DD} = 17 V	30	39	152	nA	
	I _{DVDD}	VREG18/DVDD = 1.8 V external		7	27	μA

Table 4. Digital Input/Output

Parameter	Min	Typ	Max	Unit	Test Comments/Comments
INPUT VOLTAGE ¹					
High (V _{IH})					
BCLK, FSYNC, SCL, SDA	1.13		5.5	V	
SDATA, ADDR	0.7 × VREG18/DVDD		1.98	V	
Low (V _{IL})					
BCLK, FSYNC, SDA, SCL, SDA	-0.3		+0.54	V	
ADDR	-0.3		+1.98	V	
INPUT LEAKAGE					
High (I _{IH})			1	μA	
Low (I _{IL})			1	μA	
INPUT CAPACITANCE			5	pF	
OUTPUT VOLTAGE (SDATA)					
High (V _{OH})	1.17			V	
Low (V _{OL})			0.45	V	
OUTPUT DRIVE STRENGTH ¹					
SDA	3		5	mA	
SDATA	2		24	mA	
BCLK Frequency (BCLK)	2.048		24.576	MHz	
Sample Rate (FSYNC)	8		192	kHz	

¹ The pull-up resistor for SCL and SDA must be scaled according to the external pull-up voltage in the system. The typical value for a pull-up resistor for 1.8 V is 2.2 kΩ.

DIGITAL TIMING CHARACTERISTICS

All timing specifications are given for the default setting (I²S mode) of the serial input port.

Table 5. I²C Port Timing

Parameter	Limit		Unit	Description
	Min	Max		
I ² C PORT				
f _{SCL}		400	kHz	SCL frequency
t _{SCLH}	0.6		μs	SCL high
t _{SCLL}	1.3		μs	SCL low
t _{SCS}	0.6		μs	Setup time; relevant for repeated start condition
t _{SCH}	0.6		μs	Hold time; after this period, the first clock is generated
t _{DS}	100		ns	Data setup time
t _{SCR}		300	ns	SCL rise time
t _{SCF}		300	ns	SCL fall time
t _R		300	ns	SDA rise time, not shown in Figure 2
t _F		300	ns	SDA fall time, not shown in Figure 2
t _{BFT}	0.6		μs	Bus-free time (time between stop and start)
t _{HOLD}		140	ns	SCL falling to SDA rising
	0		ns	SCL falling to SDA falling

Table 6. Digital Input Timing

Parameter	Limit		Unit	Description
	T _{MIN}	T _{MAX}		
SERIAL PORT				
t _{BIL}	15		ns	BCLK low pulse width
t _{BIH}	15		ns	BCLK high pulse width
t _{SIS}	6		ns	SDATA setup, time to BCLK rising
t _{SIH}	6		ns	SDATA hold, time from BCLK rising
t _{LIS}	10		ns	FSYNC setup time to BCLK rising
t _{LIH}	5		ns	FSYNC hold time to BCLK rising
t _{BP}	40		ns	Minimum BCLK period

Digital Timing Diagrams

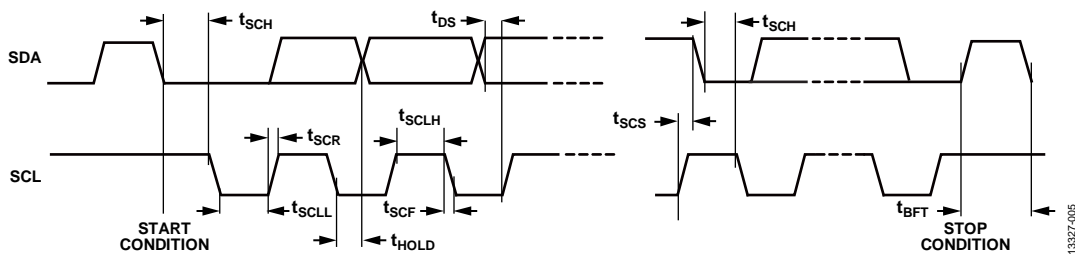

Figure 2. I²C Port Timing

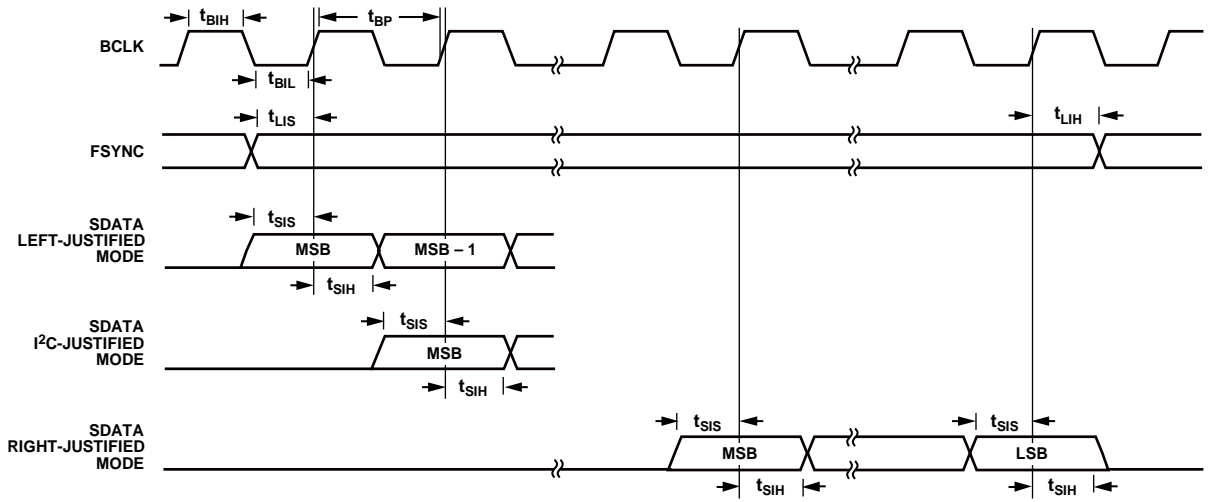

Figure 3. Serial Input Port Timing

13327-002

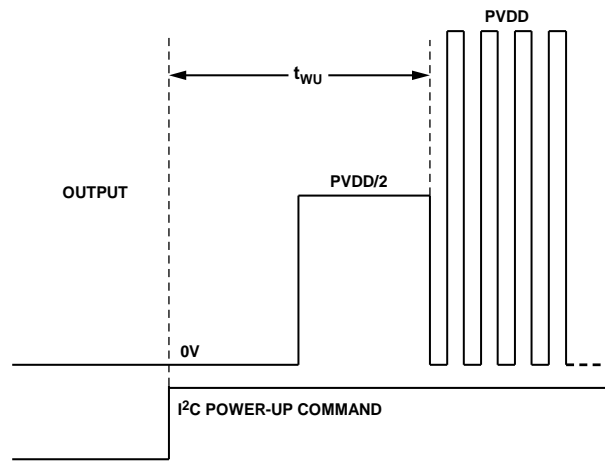

Figure 4. Turn On Hard Volume

13327-161

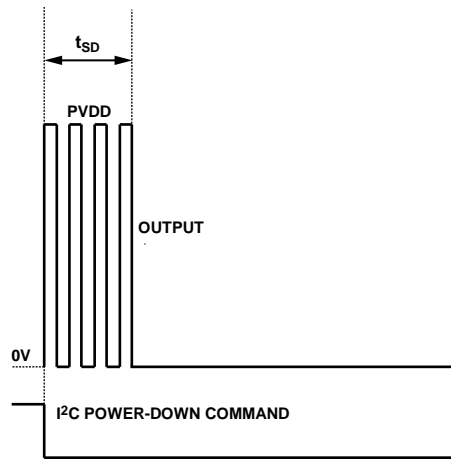

Figure 5. Turn Off Hard Volume

13327-162

ABSOLUTE MAXIMUM RATINGS

Absolute maximum ratings apply at $T_A = 25^\circ\text{C}$, unless otherwise noted.

Table 7.

Parameter	Rating
PVDD Supply Voltage	-0.3 V to +18 V
VREG18/DVDD Supply Voltage	-0.3 V to +1.98 V
VREG50/AVDD Supply Voltage	-0.3 V to +5.5 V
PGND and AGND Differential	± 0.3 V
ADDR, SDATA Input Voltage	-0.3 V to +1.98 V
SCL, SDA, BCLK, FSYNC Input Voltage	-0.3 V to +5.5 V
REG_EN Input Voltage	-0.3 V to +18 V
Storage Temperature Range	-65°C to +150°C
Operating Temperature Range	-40°C to +85°C
Junction Temperature Range	-65°C to +165°C
Lead Temperature Range (Soldering, 60 sec)	300°C

Stresses at or above those listed under Absolute Maximum Ratings may cause permanent damage to the product. This is a stress rating only; functional operation of the product at these or any other conditions above those indicated in the operational section of this specification is not implied. Operation beyond the maximum operating conditions for extended periods may affect product reliability.

THERMAL RESISTANCE

θ_{JA} (junction to air) is specified for worst case conditions, that is, a device soldered in a circuit board for surface-mount packages. θ_{JA} and θ_{JB} are determined according to JESD51-9 on a 4-layer printed circuit board (PCB) with natural convection cooling.

Table 8. Thermal Resistance

Package Type	θ_{JA}	Unit
20-Ball, 1.8 mm \times 2.2 mm WLCSP	55.5	$^\circ\text{C}/\text{W}$

ESD CAUTION



ESD (electrostatic discharge) sensitive device. Charged devices and circuit boards can discharge without detection. Although this product features patented or proprietary protection circuitry, damage may occur on devices subjected to high energy ESD. Therefore, proper ESD precautions should be taken to avoid performance degradation or loss of functionality.

PIN CONFIGURATION AND FUNCTION DESCRIPTIONS

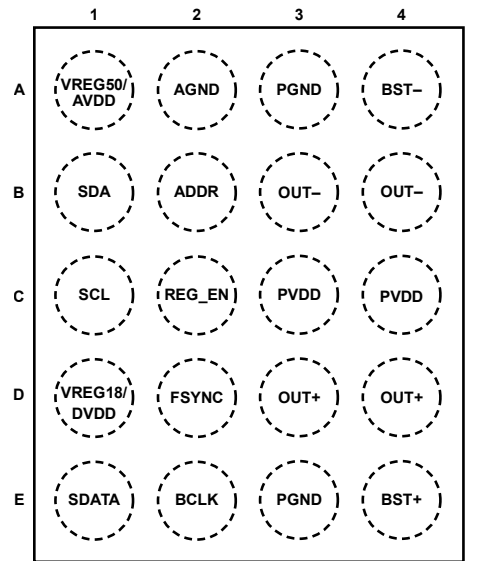

Figure 6. Pin Configuration (Top Side View)

Table 9. Pin Function Descriptions

Pin No.	Mnemonic	Type ¹	Description
A1	VREG50/AVDD	AOUT	5 V Regulator Output.
A2	AGND	PWR	Analog Ground. It is recommended to connect the AGND pin to a single ground plane on the board.
A3	PGND	PWR	Power Stage Ground. The PGND pin is shorted internally. It is recommended to connect PGND to a single ground plane on the board.
A4	BST-	AIN	Bootstrap Capacitor for OUT-.
B1	SDA	DIO	I ² C Serial Data.
B2	ADDR	DIN	I ² C Address Selection.
B3	OUT-	AOUT	Power Stage Inverting Output.
B4	OUT-	AOUT	Power Stage Inverting Output.
C1	SCL	DIN	I ² C Clock.
C2	REG_EN	AIN	Regulator Enable Tie to PVDD to Enable Regulators.
C3	PVDD	PWR	Power Stage Supply.
C4	PVDD	PWR	Power Stage Supply.
D1	VREG18/DVDD	PWR	1.8 V Regulator Output/DVDD Input.
D2	FSYNC	DIN	TDM Frame Sync Input.
D3	OUT+	AOUT	Power Stage Noninverting Output.
D4	OUT+	AOUT	Power Stage Noninverting Output.
E1	SDATA	DIO	Serial Data Input to DAC.
E2	BCLK	DIN	TDM Bit Clock Input.
E3	PGND	PWR	Power Stage Ground. The PGND pin is shorted internally. It is recommended to connect PGND to a single ground plane on the board.
E4	BST+	AIN	Bootstrap Capacitor for OUT+.

¹ AOUT is analog output; PWR is power supply or ground pin; AIN is analog input; DIO is digital input/output; DIN is digital input.

TYPICAL PERFORMANCE CHARACTERISTICS

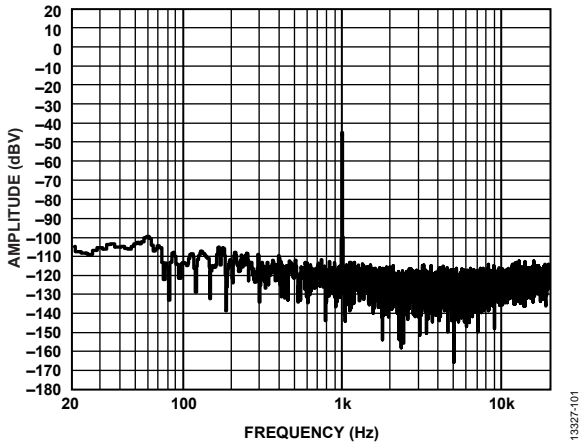

Figure 7. Fast Fourier Transform (FFT), 60 dBFS Input, Analog Gain = 8.4, $R_L = 4 \Omega$

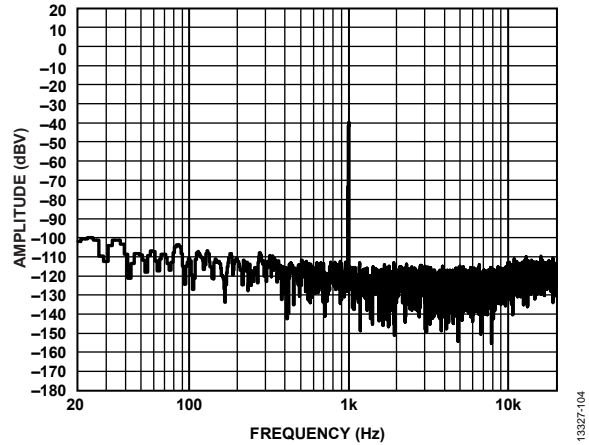

Figure 10. FFT, 60 dBFS Input, Analog Gain = 15, $R_L = 4 \Omega$

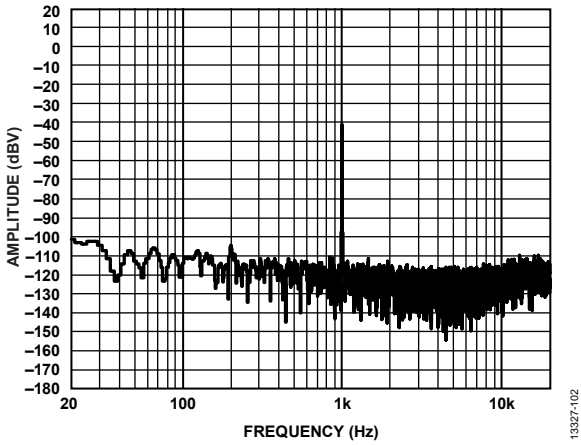

Figure 8. FFT, 60 dBFS Input, Analog Gain = 12.6, $R_L = 4 \Omega$

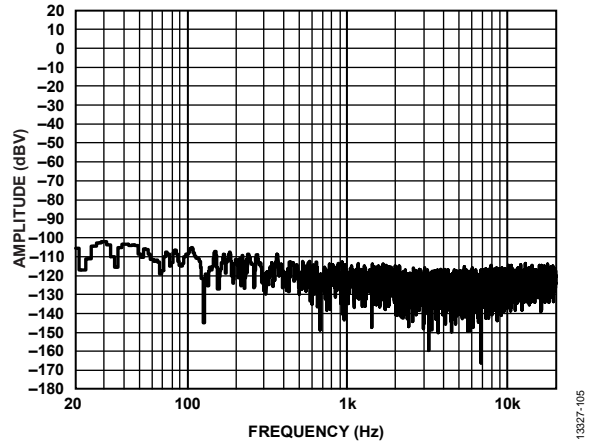

Figure 11. FFT, No Signal, Analog Gain = 8.4, $R_L = 4 \Omega$

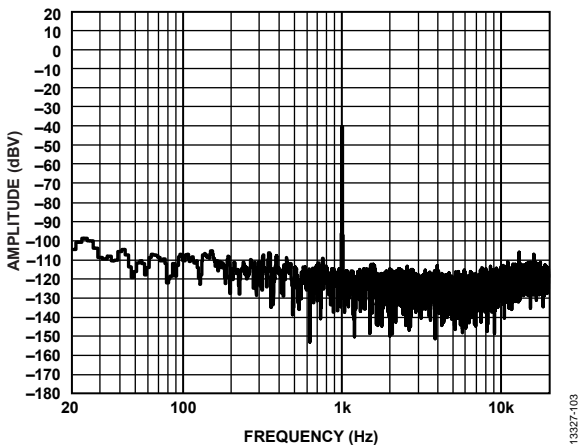

Figure 9. FFT, 60 dBFS Analog Gain = 14, $R_L = 4 \Omega$

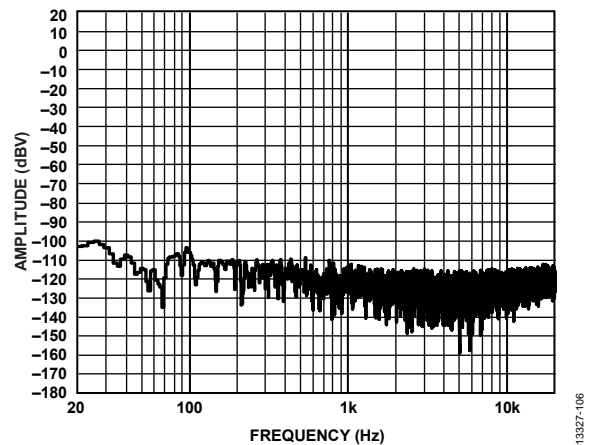

Figure 12. FFT, No Signal, Analog Gain = 12.6, $R_L = 4 \Omega$

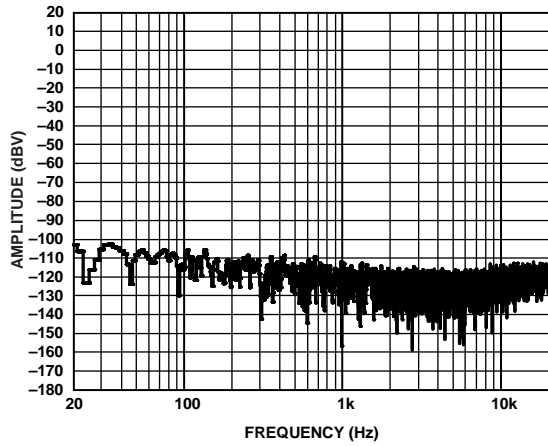

Figure 13. FFT, No Signal, Analog Gain = 14, $R_L = 4 \Omega$

13327-107

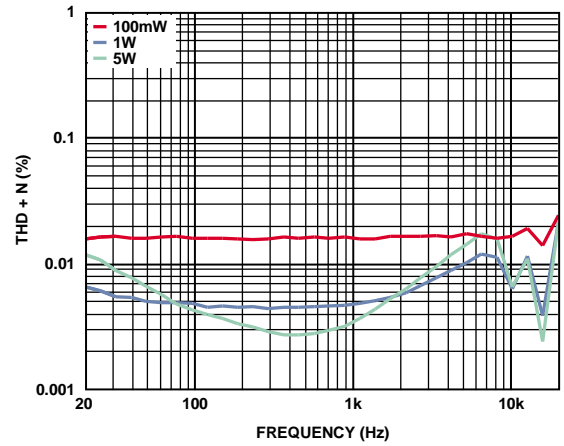

Figure 16. THD + N vs. Frequency, $R_L = 4 \Omega$, $PV_{DD} = 12 V$

13327-008

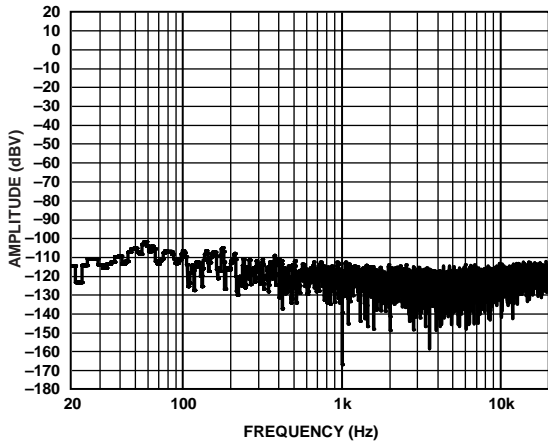

Figure 14. FFT, No Signal, Analog Gain = 15, $R_L = 4 \Omega$

13327-108

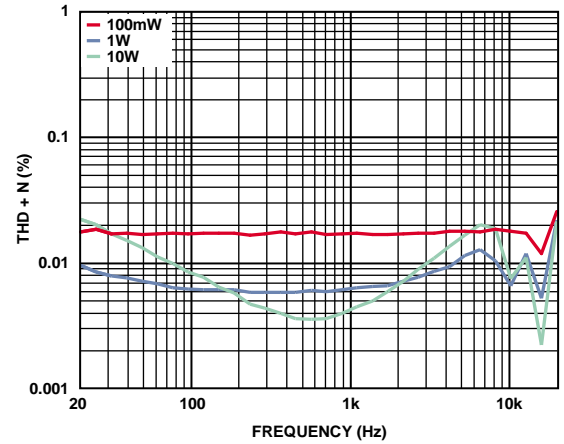

Figure 17. THD + N vs. Frequency, $R_L = 4 \Omega$, $PV_{DD} = 17 V$

13327-009

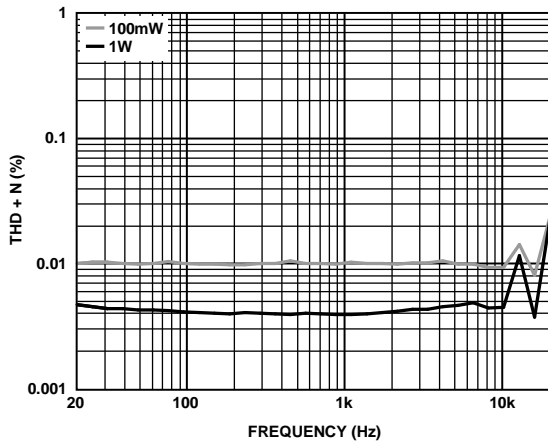

Figure 15. THD + N vs. Frequency into $R_L = 4 \Omega$, $PV_{DD} = 4.5 V$

13327-007

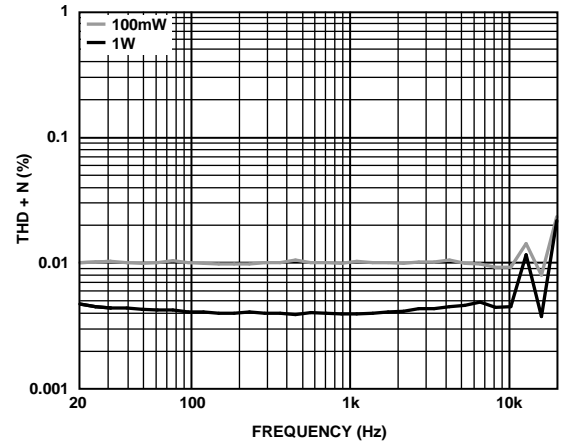

Figure 18. THD + N vs. Frequency, $R_L = 8 \Omega$, $PV_{DD} = 4.5 V$

13327-010

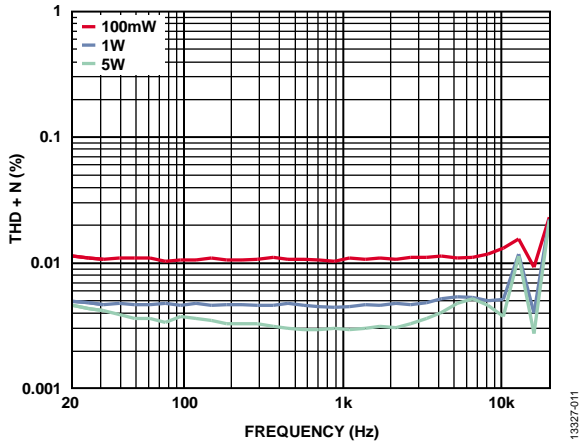

Figure 19. THD + N vs. Frequency, $R_L = 8 \Omega$, $PV_{DD} = 12 V$

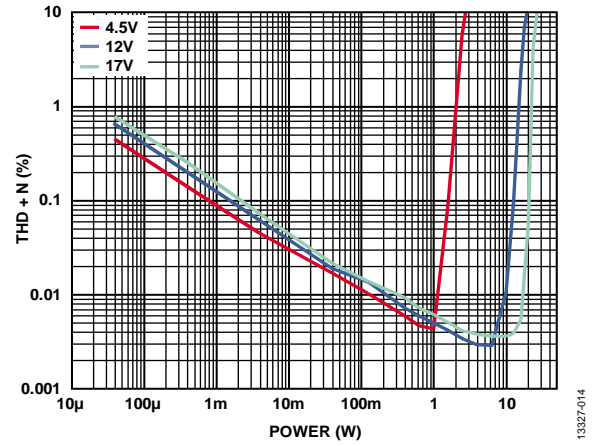

Figure 22. THD + N vs. Output Power, $R_L = 4 \Omega$, Analog Gain = 12.6

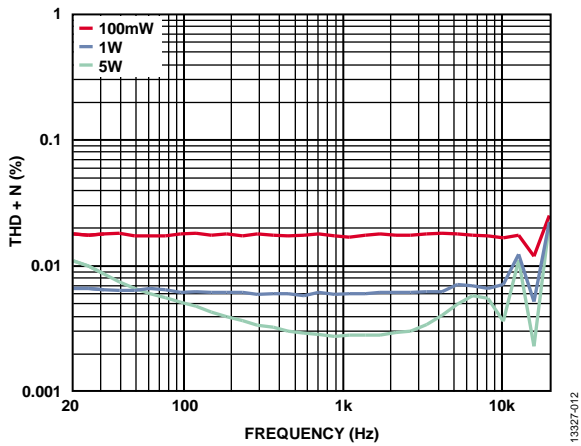

Figure 20. THD + N vs. Frequency, $R_L = 8 \Omega$, $PV_{DD} = 17 V$

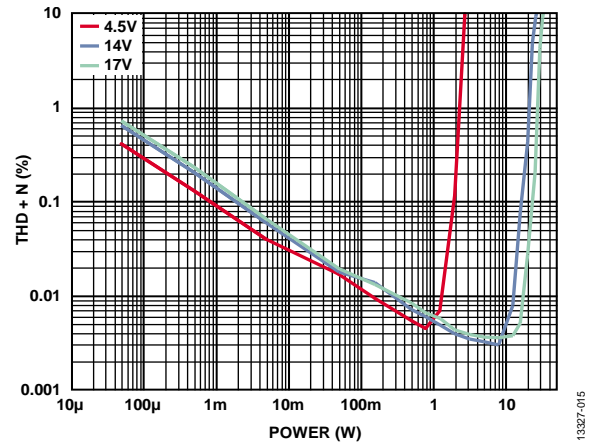

Figure 23. THD + N vs. Output Power, $R_L = 4 \Omega$, Analog Gain = 14

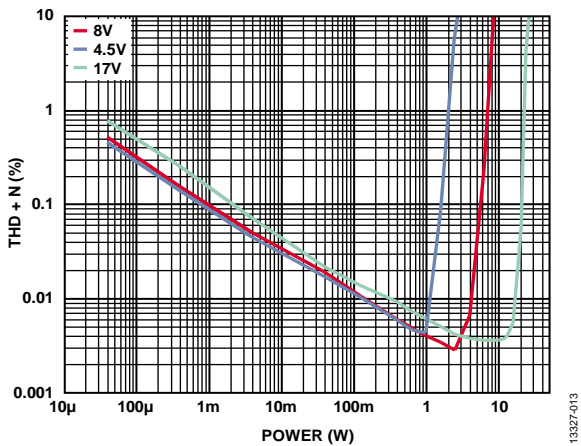

Figure 21. THD + N vs. Output Power, $R_L = 4 \Omega$, Analog Gain = 8.4

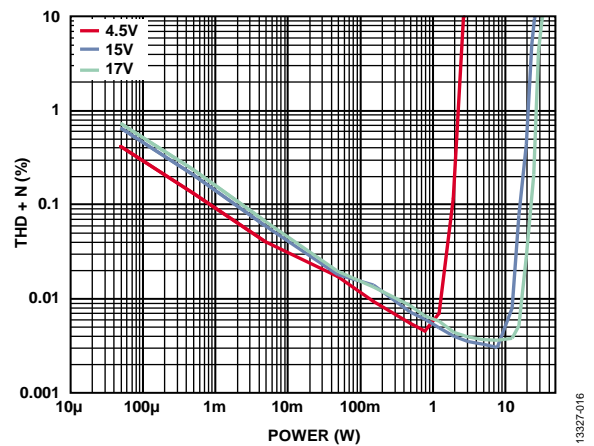

Figure 24. THD + N vs. Output Power, $R_L = 4 \Omega$, Analog Gain = 15

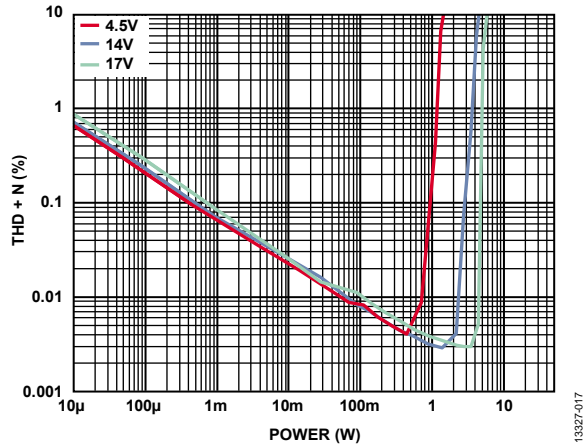

Figure 25. THD + N vs. Output Power, $R_L = 8 \Omega$, Analog Gain = 8.4

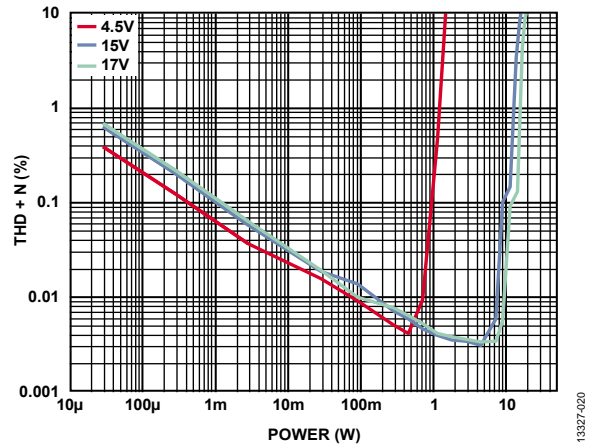

Figure 28. THD + N vs. Output Power, $R_L = 8 \Omega$, Analog Gain = 15

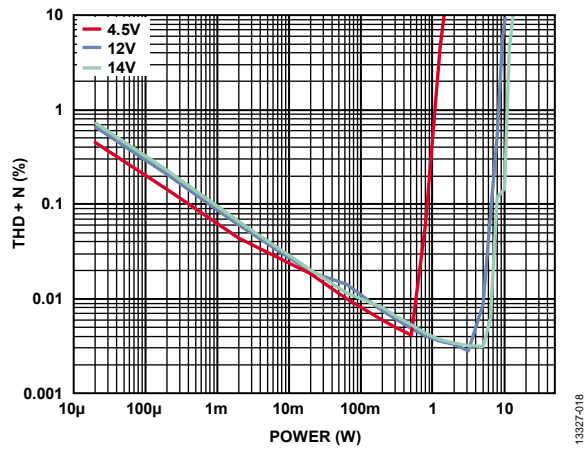

Figure 26. THD + N vs. Output Power, $R_L = 8 \Omega$, Analog Gain = 12.6

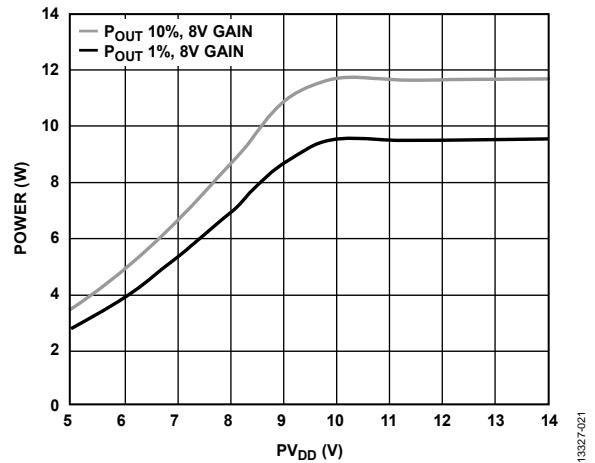

Figure 29. Output Power vs. PV_{DD} Supply Voltage (PV_{DD}), $R_L = 4 \Omega$, Analog Gain = 8.4

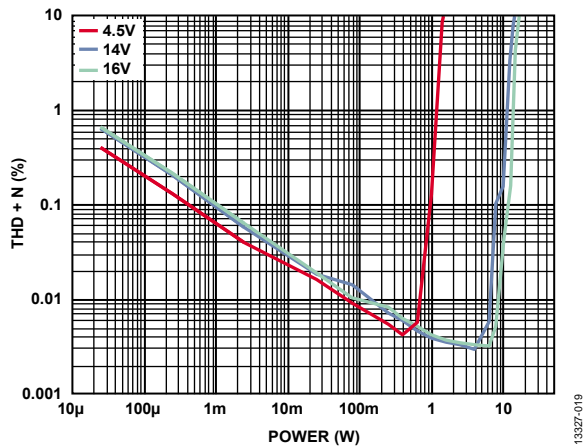

Figure 27. THD + N vs. Output Power, $R_L = 8 \Omega$, Analog Gain = 14

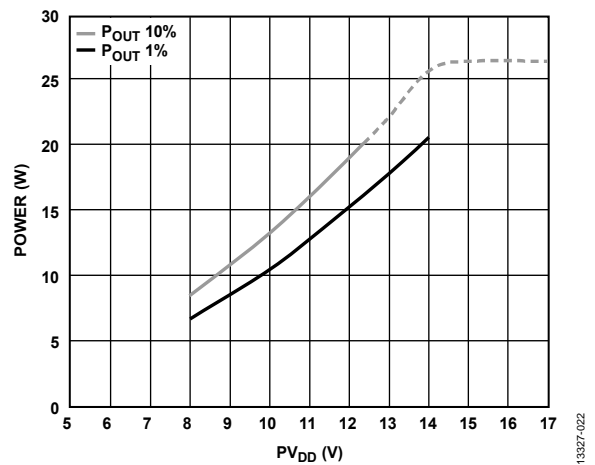

Figure 30. Output Power vs. PV_{DD} , $R_L = 4 \Omega$, Analog Gain = 12.6

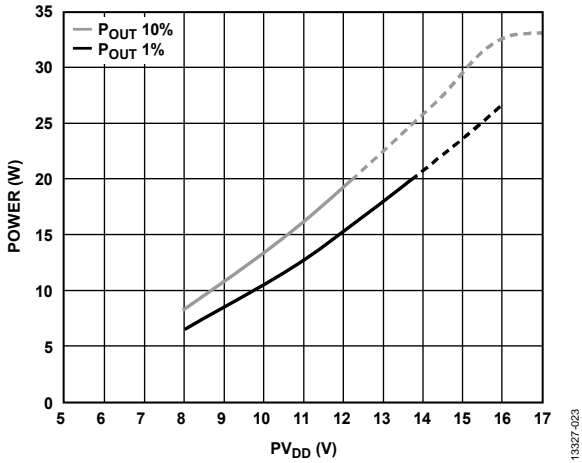

Figure 31. Output Power vs. P_{VDD} , $R_L = 4 \Omega$, Analog Gain = 14

13327-023

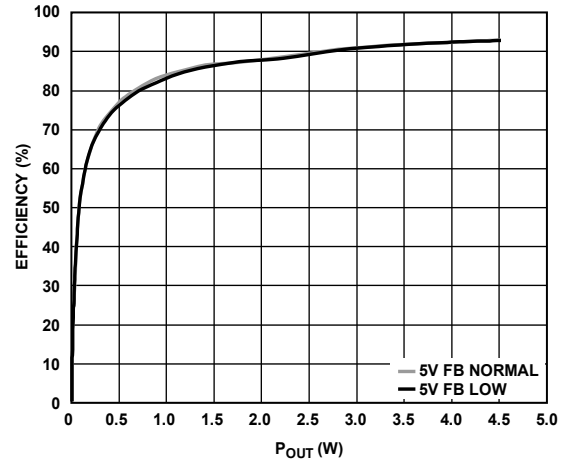

Figure 34. Efficiency vs. P_{OUT} , $R_L = 4 \Omega$, FB and 220 pF Capacitor, $P_{VDD} = 5 V$, Analog Gain = 8.4

13327-026

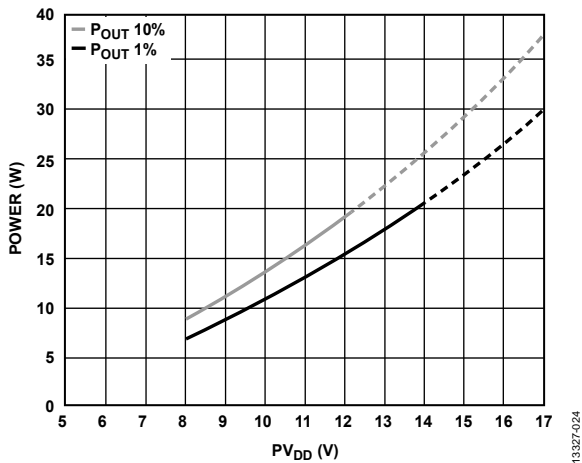

Figure 32. Output Power vs. P_{VDD} , $R_L = 4 \Omega$, Analog Gain = 15

13327-024

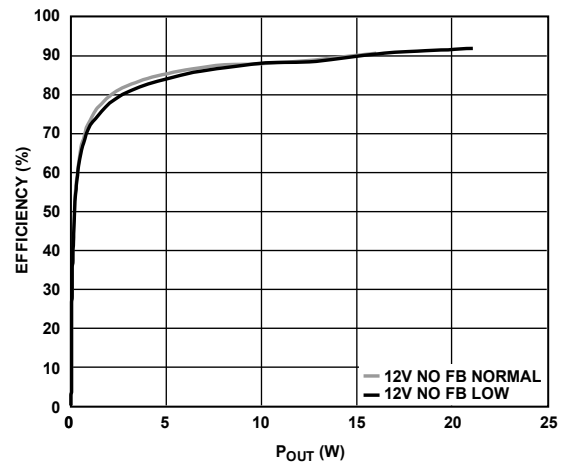

Figure 35. Efficiency vs. P_{OUT} , $R_L = 4 \Omega$, No FB and 220 pF, $P_{VDD} = 12 V$, Analog Gain = 12.6

13327-027

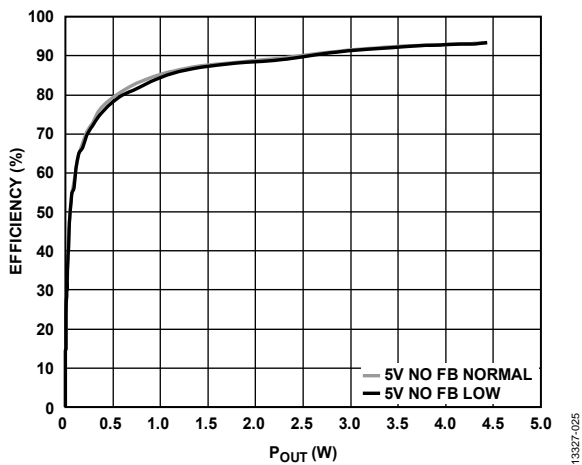

Figure 33. Efficiency vs. Output Power (P_{OUT}), $R_L = 4 \Omega$, No Ferrite Bead (FB) and 220 pF Capacitor, $P_{VDD} = 5 V$, Analog Gain = 8.4

13327-025

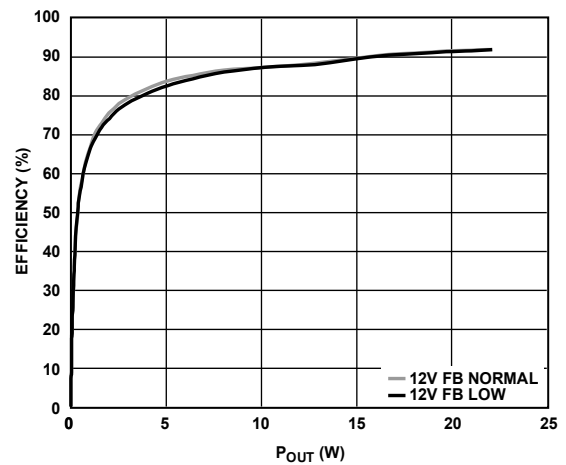

Figure 36. Efficiency vs. P_{OUT} , $R_L = 4 \Omega$, FB and 220 pF Capacitor, $P_{VDD} = 12 V$, Analog Gain = 12.6

13327-028

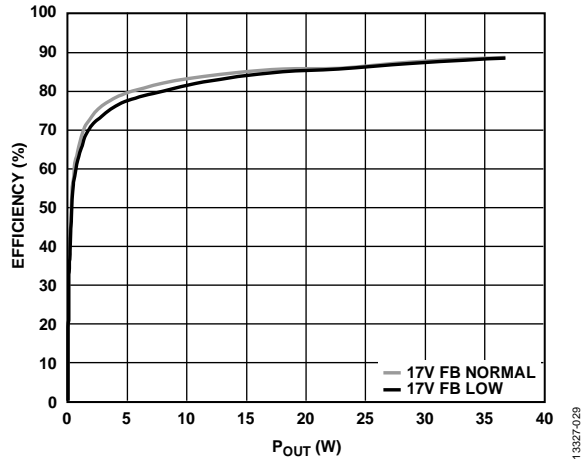

Figure 37. Efficiency vs. P_{OUT} , $R_L = 4 \Omega$, FB and 220 pF Capacitor, $PV_{DD} = 17 V$, Analog Gain = 14

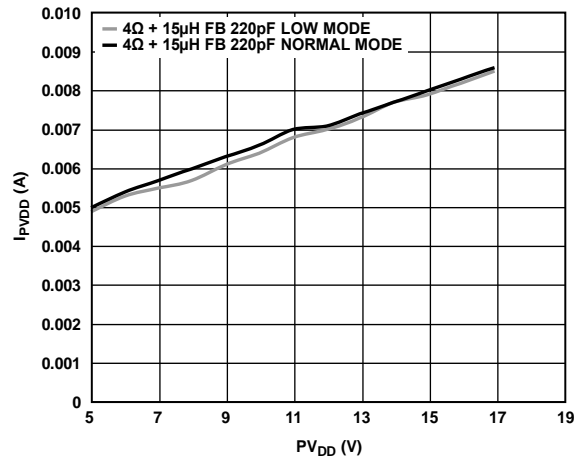

Figure 40. Quiescent Current, $R_L = 4 \Omega$, FB and 220 pF Capacitor, Analog Gain = 12

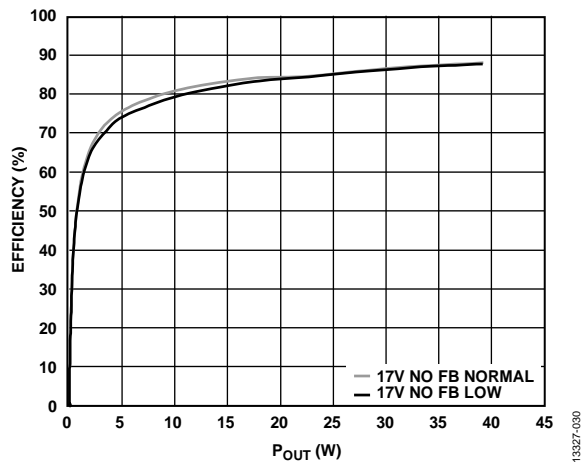

Figure 38. Efficiency vs. P_{OUT} , $R_L = 4 \Omega$, No FB and 220 pF Capacitor, $PV_{DD} = 17 V$, Analog Gain = 14

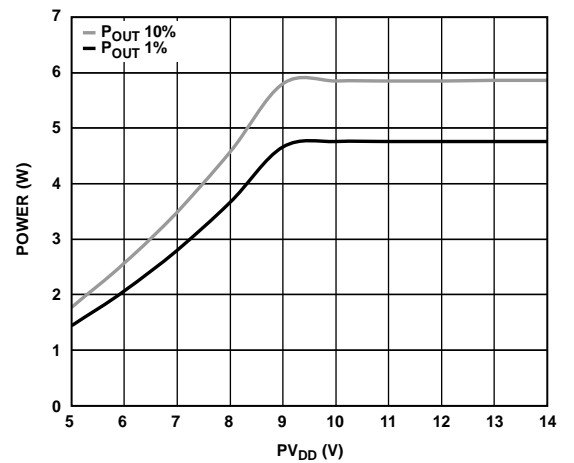

Figure 41. Output Power vs. PV_{DD} , $R_L = 8 \Omega$, Analog Gain = 8

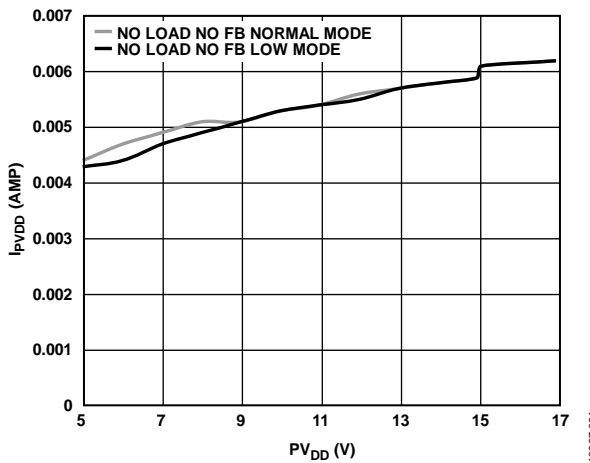

Figure 39. Quiescent Current, $R_L = 4 \Omega$, No FB and 220 pF Capacitor, Analog Gain = 12

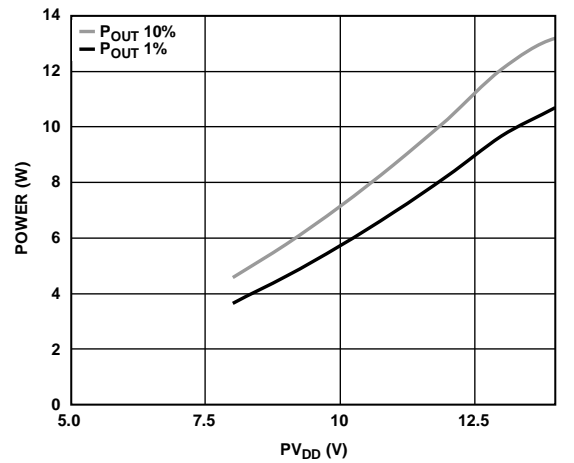

Figure 42. Output Power vs. PV_{DD} , $R_L = 8 \Omega$, Analog Gain = 12

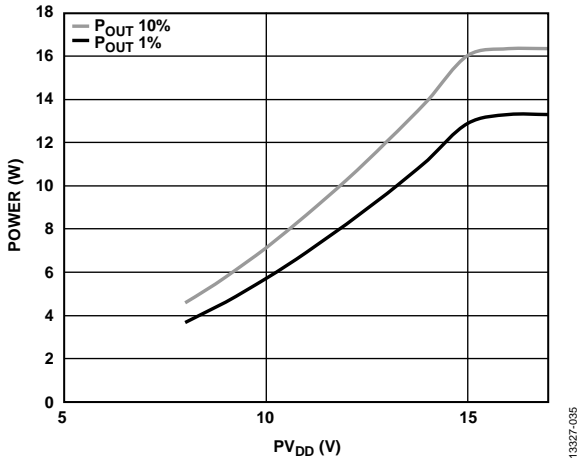

Figure 43. Output Power vs. P_{VDD} , $R_L = 8 \Omega$, Analog Gain = 14

13327-035

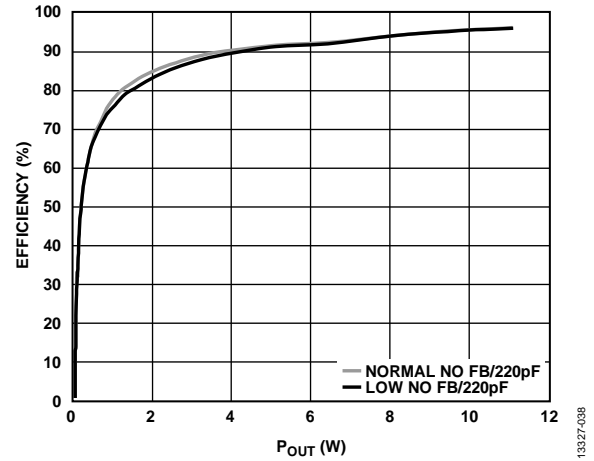

Figure 46. Efficiency vs. P_{OUT} , $R_L = 8 \Omega$, No FB and 220 pF Capacitor, $P_{VDD} = 12 V$, Analog Gain = 12.6

13327-038

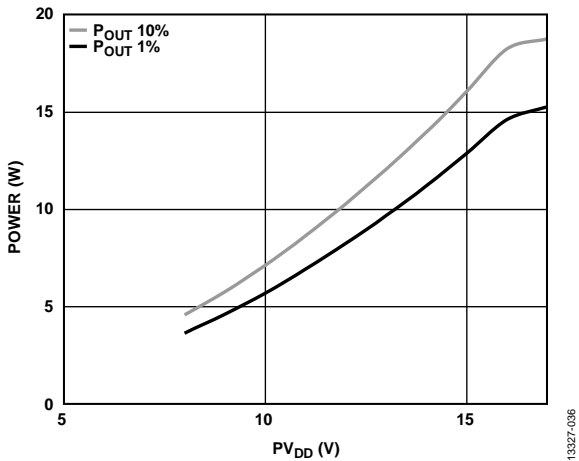

Figure 44. Output Power vs. P_{VDD} , $R_L = 8 \Omega$, Analog Gain = 15

13327-036

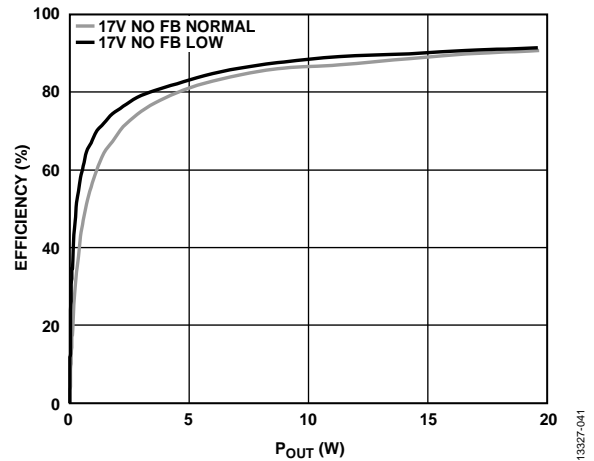

Figure 47. Efficiency vs. P_{OUT} , $R_L = 8 \Omega$, No FB and 220 pF Capacitor, $P_{VDD} = 17 V$, Analog Gain = 14

13327-041

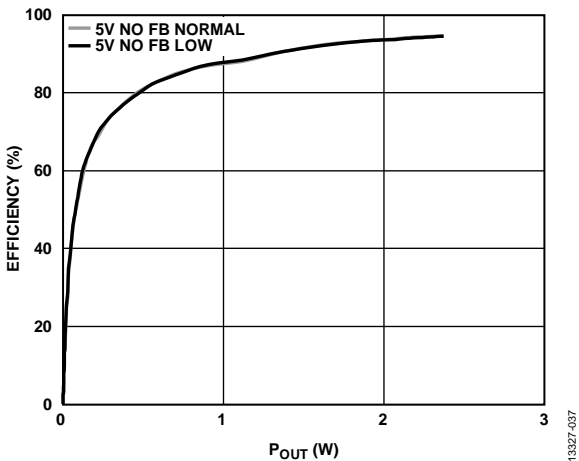

Figure 45. Efficiency vs. P_{OUT} , $R_L = 8 \Omega$, No FB and 220 pF Capacitor, $P_{VDD} = 5 V$, Analog Gain = 8.4

13327-037

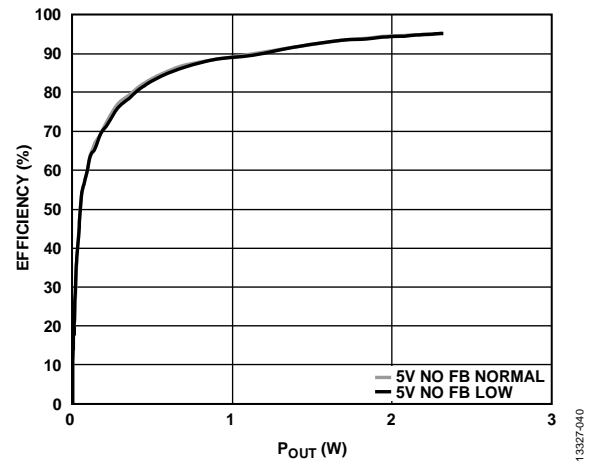

Figure 48. Efficiency vs. P_{OUT} , $R_L = 8 \Omega$, FB and 220 pF Capacitor, $P_{VDD} = 5 V$, Analog Gain = 8.4

13327-040

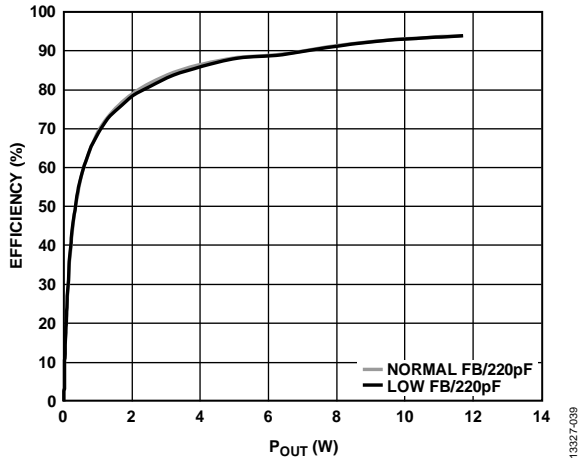

Figure 49. Efficiency vs. P_{OUT} , $R_L = 8\ \Omega$, FB and 220 pF Capacitor, $PV_{DD} = 12\ V$, Analog Gain = 12.6

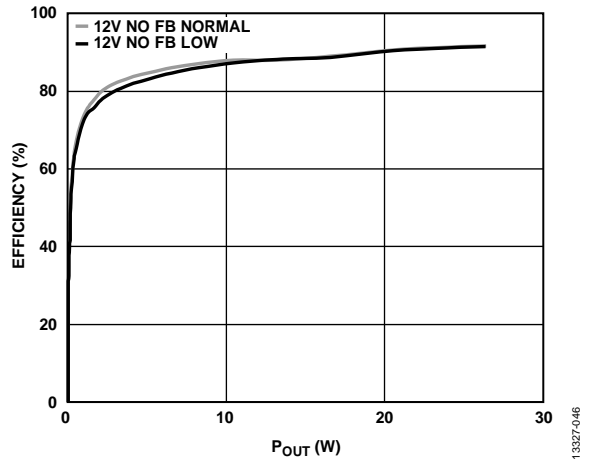

Figure 52. Efficiency vs. P_{OUT} , $R_L = 3\ \Omega$, No FB and 220 pF Capacitor, $PV_{DD} = 12\ V$, Analog Gain = 12.6

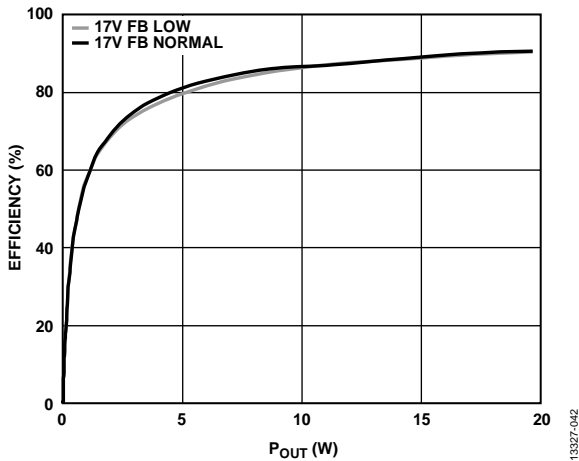

Figure 50. Efficiency vs. P_{OUT} , $R_L = 8\ \Omega$, FB and 220 pF Capacitor, $PV_{DD} = 17\ V$, Analog Gain = 14

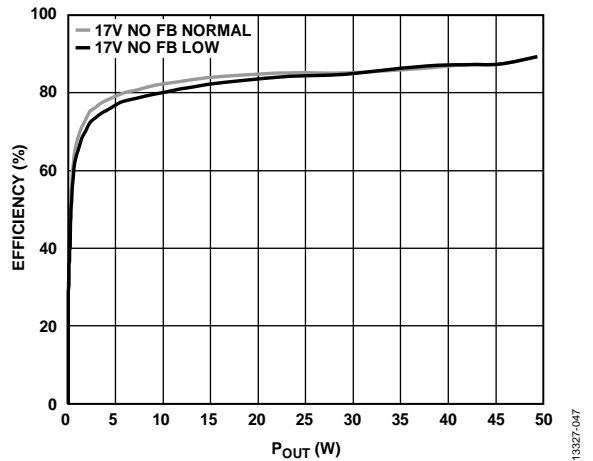

Figure 53. Efficiency vs. P_{OUT} , $R_L = 3\ \Omega$, No FB and 220 pF Capacitor, $PV_{DD} = 17\ V$, Analog Gain = 14

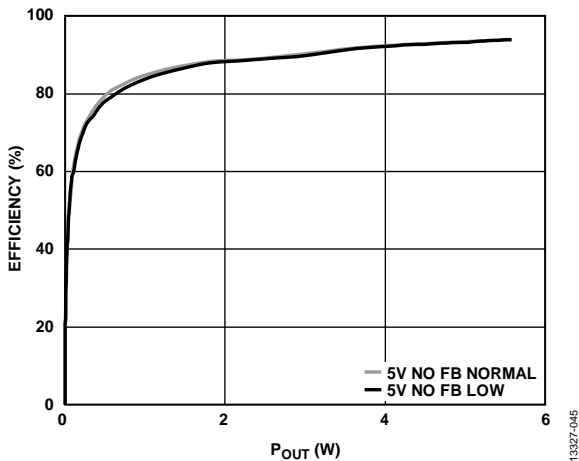

Figure 51. Efficiency vs. P_{OUT} , $R_L = 3\ \Omega$, No FB and 220 pF Capacitor, $PV_{DD} = 5\ V$, Analog Gain = 8.4

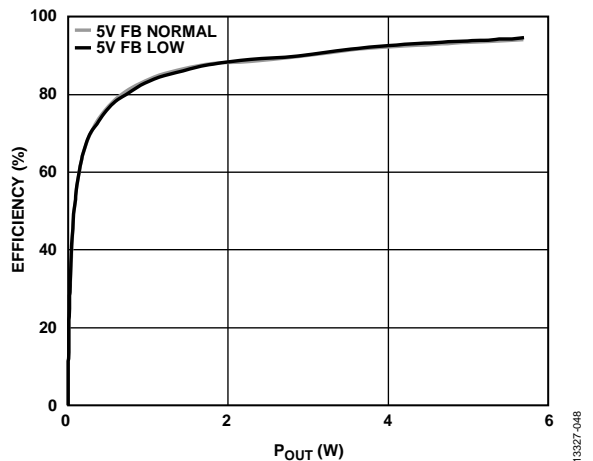

Figure 54. Efficiency vs. P_{OUT} , $R_L = 3\ \Omega$, FB and 220 pF Capacitor, $PV_{DD} = 5\ V$, Analog Gain = 8.4

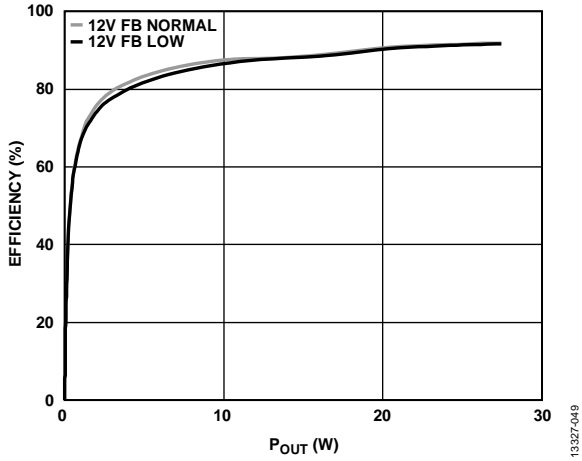

Figure 55. Efficiency vs. P_{OUT} , $R_L = 3 \Omega$, FB and 220 pF Capacitor, $PV_{DD} = 12 V$, Analog Gain = 12.6

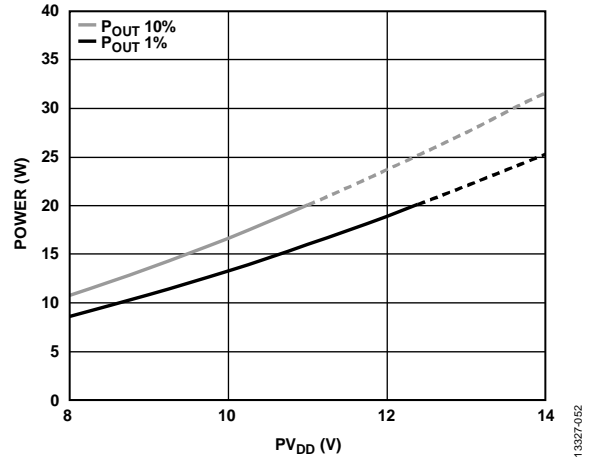

Figure 58. Output Power vs. PV_{DD} , $R_L = 3 \Omega$, Analog Gain = 12.6

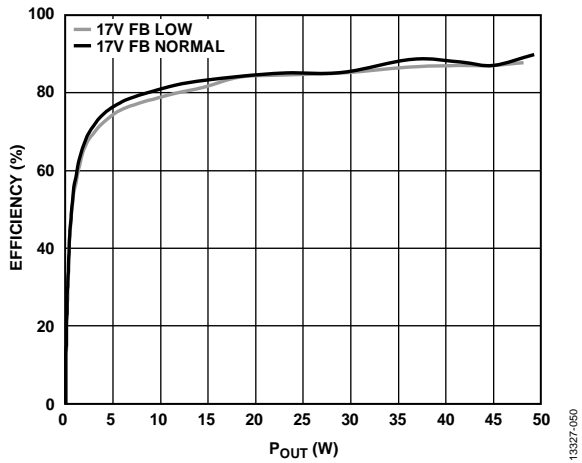

Figure 56. Efficiency vs. P_{OUT} , $R_L = 3 \Omega$, FB and 220 pF Capacitor, $PV_{DD} = 17 V$, Analog Gain = 14

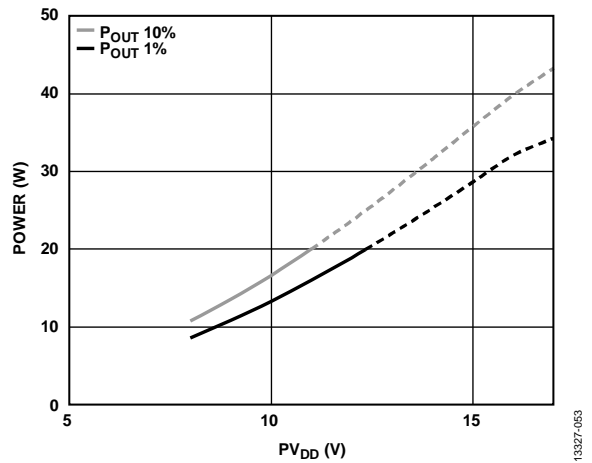

Figure 59. Output Power vs. PV_{DD} , $R_L = 3 \Omega$, Analog Gain = 14

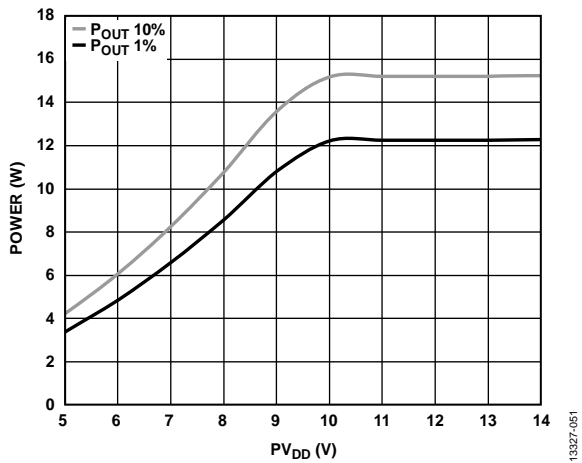

Figure 57. Output Power vs. PV_{DD} , $R_L = 3 \Omega$, Analog Gain = 8.4

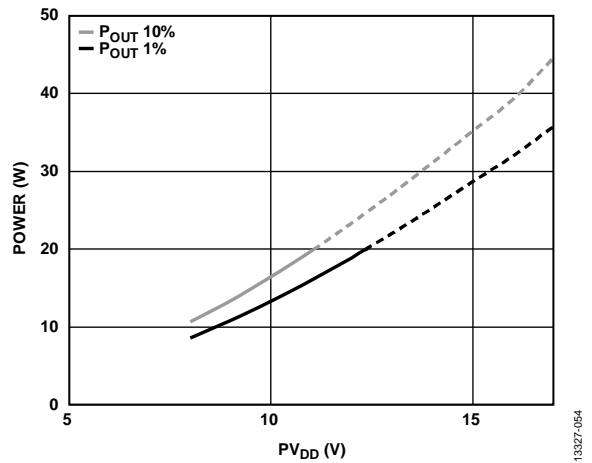

Figure 60. Output Power vs. PV_{DD} , $R_L = 3 \Omega$, Analog Gain = 15

THEORY OF OPERATION

OVERVIEW

The [SSM3515](#) Class-D audio amplifier features a filterless modulation scheme that greatly reduces the external component count, conserving board space and reducing system cost. The [SSM3515](#) does not require an output filter; it relies on the inherent inductance of the speaker coil and the natural filtering of the speaker and human ear to recover the audio component of the square wave output.

Most Class-D amplifiers use some variation of pulse-width modulation (PWM), but the [SSM3515](#) uses Σ - Δ modulation to determine the switching pattern of the output devices, resulting in a number of important benefits. Σ - Δ modulators do not produce a sharp peak with many harmonics in the AM broadcast band, as pulse-width modulators often do. Σ - Δ modulation reduces the amplitude of spectral components at high frequencies, reducing EMI emission that may otherwise be radiated by speakers and long cable traces. Due to the inherent spread spectrum nature of Σ - Δ modulation, the need for oscillator synchronization is eliminated for designs incorporating multiple [SSM3515](#) amplifiers.

The [SSM3515](#) also integrates overcurrent and temperature protection and a thermal warning with optional programmable gain reduction.

POWER SUPPLIES

The power supply pins on the [SSM3515](#) are PVDD, VREG50/AVDD, and VREG18/DVDD.

PVDD, the battery supply, is used for the output stage and also supplies power to the 5 V regulator. In addition, it can be used to supply power to the 1.8 V regulator. This pin must be decoupled to ground using a 100 nF capacitor in parallel with a 1 μ F MLCC capacitor to ground as close as possible to the respective pins. In addition, a bulk electrolytic capacitor may be required depending on the output power to supply the current at low frequency output. Typically, 220 μ F and 25 V is recommended. This must be sized according to the power supply regulation in the system.

VREG50/AVDD (5 V) is the analog supply used for the input stage, modulator, power stage driver, and other blocks. It uses the VREG50/AVDD pin. It is generated internally by the integrated 5 V linear regulator. This pin must be decoupled to ground using the 100 nF and 10 μ F capacitor.

VREG18/DVDD (1.8 V) is the supply for the digital circuitry. It uses the VREG18/DVDD pin. It can be generated internally using an integrated 1.8 V linear regulator. Alternatively, an external 1.8 V supply can be used to save the power dissipation. The VREG18/DVDD pin must be decoupled to ground using 100 nF and 10 μ F MLCC capacitors close to the pin.

POWER-UP SEQUENCE

If the REG_EN pin is tied to PVDD, the power-up sequence is performed internally. As the PVDD voltage ramps up, the VREG18/DVDD voltage (generated internally) also ramps up. The typical wait time before the I²C commands can be sent to the device depends on the PVDD supply ramp-up time.

If the REG_EN pin is tied low, ensure that 1.8 V is supplied externally and that PV_{DD} is greater than 4.5 V before sending I²C commands to enable the device.

POWER-DOWN OPERATION

The [SSM3515](#) offers several power down options via I²C. Register 0x00 provides multiple options for setting the various power-down modes.

Set the SPWDN bit to 1 to fully power down the device. Only the I²C, 1.8 V regulator is kept alive.

The [SSM3515](#) monitors both the BCLK and FSYNC pins for clock presence when in 2-wire mode. When no BCLK or FSYNC signals are present, the device automatically powers down all internal circuitry to its lowest power state. When a BCLK or FSYNC signal returns, the device automatically powers up following its usual power up sequence.

When enabled, the APWDN_EN bit (auto power down), activates a low power state as soon as 2048 consecutive zero input samples are received. Only the I²C and digital audio input blocks are kept active.

REG_EN PIN SETUP AND CONTROL

The REG_EN (regulator enable) pin enables or disables the internal 1.8 V regulator.

Table 10. Regulator Enable Pin Function

REG_EN	1.8 V Regulator	Comment
Ground	Disabled	External 1.8 V
PVDD	Enabled	Internal 1.8 V

The status of the REG_EN pin determines if the 1.8 V supply is generated internally or if it must be provided externally. If the REG_EN pin is tied to PVDD, the internal 1.8 V regulator is enabled. If the REG_EN pin is tied to ground, a 1.8 V supply must be supplied externally to the VREG18/DVDD pin for the device to operate. For the device to respond to I²C commands, the 1.8 V supply must be stable.

ADDR PIN SETUP AND CONTROL

The ADDR pin sets the device I²C address. See Table 11 for details.

CLOCKING

In 3-wire mode (BCLK, FSYNC, SDATA), a BCLK signal must be provided to the [SSM3515](#) for correct operation. The BCLK

signal must have a minimum frequency of 2.048 MHz. The BCLK signal is used for internal clocking of the device. The BCLK rate is detected automatically, but the sampling frequency must be known to the device. The supported BCLK rates at 32 kHz to 48 kHz are 50, 64, 100, 128, 192, 200, 256, 384, 400, and 512 times the sample rate.

Table 11. Pin Setup List

ADDR Pin	SCL Pin	SDA Pin	Control Mode	7-Bit I ² C Address	TDM Slot
Connected to Ground Using a 47 k Ω Resistor	SCL	SDA	I ² C	0x14	1
Open (No Connection)	SCL	SDA	I ² C	0x15	2
Connected to 1.8 V Using a 47 k Ω Resistor	SCL	SDA	I ² C	0x16	3
Connected to 1.8 V	SCL	SDA	I ² C	0x17	4

DIGITAL AUDIO SERIAL INTERFACE

The **SSM3515** includes a standard serial audio interface that is slave only. The interface is capable of receiving I²S, left justified, PCM, or TDM formatted data.

The serial interface has three main operating modes, listed in Table 12.

Table 12. Operating Modes

Mode	Format	Comments
2-Channel (Stereo)	I ² S/left justified	Register control using I ² C port
Multichannel TDM	I ² S/left justified	Register control using I ² C port

Stereo modes, typically I²S or left justified, are used when there is one or two devices on the interface bus. Standard multichannel TDM modes are more flexible and offer the ability to have multiple devices on the bus. In both of these cases, the register control uses an I²C port.

STEREO (I²S/LEFT JUSTIFIED) OPERATING MODE

Stereo modes use both edges of FSYNC to determine placement of data. Stereo mode is enabled when SAI_MODE = 0 and the data format is determined by the SDATA_FMT register setting.

The I²S or left justified interface formats accept any number of BCLK cycles per FSYNC cycle. Sample rates from 8 kHz to 192 kHz are accepted. The maximum BCLK rate is 24.576 MHz.

TDM OPERATING MODE

The TDM operating mode allows multiple chips to use a single serial interface bus for audio data.

The FSYNC signal operates at the desired sample rate. A rising edge of the FSYNC signal indicates the start of a new frame. For proper operation, this signal must be one BCLK cycle wide, transitioning on a falling BCLK edge. The MSB of data must be present on the SDATA one BCLK cycle later. The SDATA signal latches on the rising edge of BCLK.

Each chip on the TDM bus can occupy 16, 24, 32, 48, or 64 BCLK cycles. This is set with the TDM_BCLKS bits and all devices on the bus must have the same setting. Up to 16 **SSM3515** devices can be used on a single TDM bus, but only 4 unique I²C device addresses are available. The **SSM3515** automatically determines how many possible devices can be placed on the bus from the BCLK rate. There is no limit to the total number of BCLK cycles per FSYNC pulse.

Which chip slot each **SSM3515** uses is determined by the ADDR pin settings (see Table 11 for details), or by the TDM_SLOT bits in Register 0x05.

The input data width to the DAC can be either 16-bit or 24-bit.

I²C CONTROL

The **SSM3515** supports a 2-wire serial (I²C-compatible) microprocessor bus driving multiple peripherals. Two pins, serial data (SDA) and serial clock (SCL), carry information between the **SSM3515** and the system I²C master controller. The **SSM3515** is always a slave on the bus, meaning it cannot initiate a data transfer. Each slave device is recognized by a unique address. Using the ADDR pin provides the four device addresses, which are listed in Table 11. The address byte format is shown in Table 13. The address resides in the first seven bits of the I²C write. The LSB of this byte sets either a read or write operation. Logic Level 1 corresponds to a read operation, and Logic Level 0 corresponds to a write operation.

Connect 2.2 k Ω pull-up resistors on the lines connected to the SDA and SCL pins. The voltage on these signal lines must not be more than 5 V.

Addressing

Initially, each device on the I²C bus is in an idle state, monitoring the SDA and SCL lines for a start condition and the proper address. The I²C master initiates a data transfer by establishing a start condition, defined by a high to low transition on SDA while SCL remains high. This indicates that an address or data stream follows. All devices on the bus respond to the start condition and shift the next eight bits (the 7-bit address plus the R/W bit) MSB first. The device that recognizes the transmitted address responds by pulling the data line low during the ninth clock pulse. This ninth bit is an acknowledge bit. All other devices withdraw from the bus at this point and return to the idle condition. The device address for the **SSM3515** is determined by the state of the ADDR pin. See Table 11 for four available addresses.

The R/W bit determines the direction of the data. A Logic 0 on the LSB of the first byte means the master writes information to the peripheral, whereas a Logic 1 means the master reads information from the peripheral after writing the subaddress and repeating the start address. A data transfer occurs until a stop condition is encountered. A stop condition occurs when SDA transitions from low to high while SCL is held high. The timing for the I²C port is shown in Figure 61.

Stop and start conditions can be detected at any stage during the data transfer. If these conditions are asserted out of sequence with normal read and write operations, the **SSM3515** immediately jumps to the idle condition. During a given SCL high period, the user must issue only one start condition, one stop condition, or a single stop condition followed by a single start condition. If the user issues an invalid subaddress, the **SSM3515** does not issue an acknowledge and returns to the idle condition. If the user exceeds the highest subaddress while in auto-increment mode, one of two actions is taken.

In read mode, the SSM3515 outputs the highest subaddress register contents until the master device issues a no acknowledge, indicating the end of a read. A no acknowledge condition is when the SDA line is not pulled low on the ninth clock pulse on SCL. If the highest subaddress location is reached while in write mode, the data for the invalid byte is not loaded into any subaddress register, a no acknowledge is issued by the SSM3515, and the device returns to the idle condition.

I²C Read and Write Operations

Figure 62 shows the timing of a single-word write operation. Every ninth clock, the SSM3515 issues an acknowledge (ACK) by pulling SDA low.

Figure 63 shows the timing of a burst mode write sequence. This figure shows an example in which the target destination registers are two bytes. The SSM3515 increments its subaddress register

every byte because the requested subaddress corresponds to a register or memory area with a byte word length.

The timing of a single word read operation is shown in Figure 64. Note that the first R/W bit is 0, indicating a write operation.

This is because the subaddress still must be written to set up the internal address. After the SSM3515 acknowledges the receipt of the subaddress, the master must issue a repeated start command followed by the chip address byte with the R/W set to 1 (read). This causes the SSM3515 SDA to reverse and begin driving data back to the master. The master then responds every ninth pulse with an acknowledge pulse to the SSM3515. See Table 15 for a list of abbreviations in Figure 62 through Figure 65.

Table 13. I²C Device Address Byte Format Using the ADDR Pin¹

Bit 0	Bit 1	Bit 2	Bit 3	Bit 4	Bit 5	Bit 6	Bit 7
0	0	1	0	1	X	X	R/W

¹ X means don't care.

Table 14. ADDR Pin to I²C Device Address Mapping

ADDR Pin	ADDR Voltage	I ² C Address Bit 5	I ² C Address Bit 6
GND	GND	Not applicable	Not applicable
Pull-Down 47 kΩ Resistor	$0.25 \times V_{REG18}/DVDD$	0	0
Open	$0.5 \times V_{REG18}/DVDD$	0	1
Pull-Up 47 kΩ Resistor	$0.75 \times V_{REG18}/DVDD$	1	0
DVDD	DVDD	1	1

Table 15. Abbreviations for Figure 62 Through Figure 65

Symbol	Meaning
S	Start bit
P	Stop bit
A _M	Acknowledge by master
A _S	Acknowledge by slave

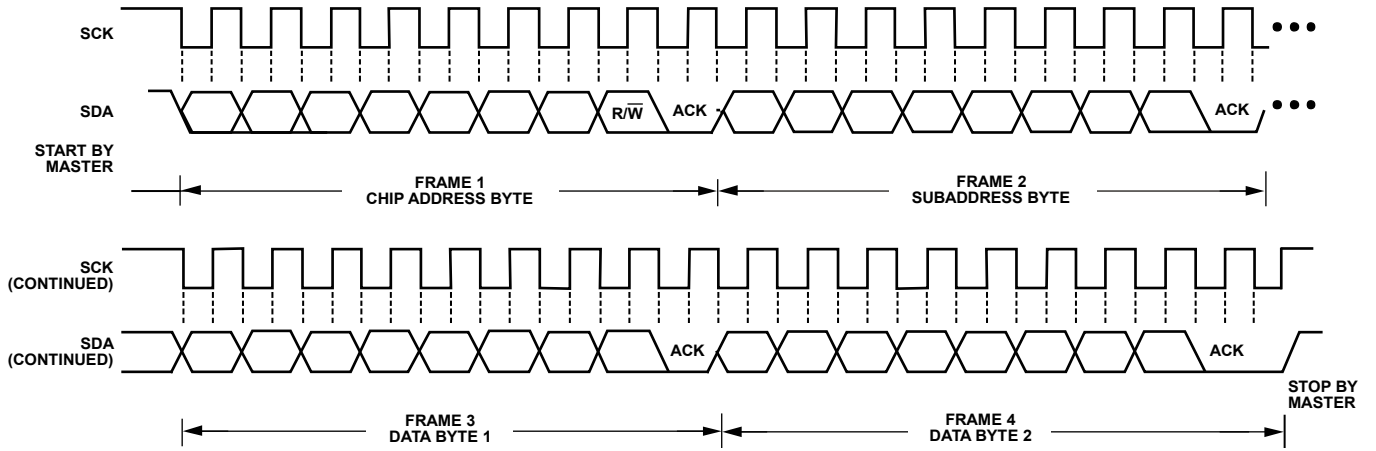

Figure 61. I²C Read/Write Timing

13327-066

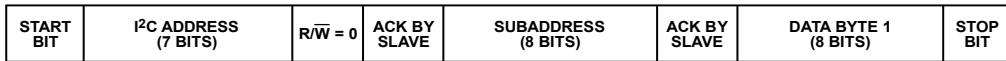

Figure 62. Single Word I²C Write Format

13327-067

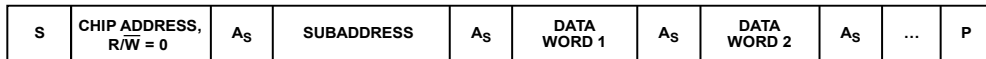

Figure 63. Burst Mode I²C Write Format

13327-068



Figure 64. Single Word I²C Read Format

13327-069

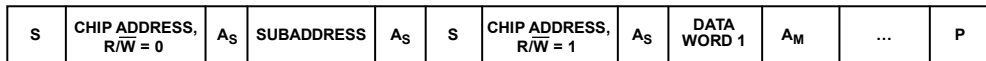

Figure 65. Burst Mode I²C Read Format

13327-070

ANALOG AND DIGITAL GAIN

Several selectable settings are available for the analog gain of the system. These provide optimal gain settings at various PVDD supply voltages. The ANA_GAIN bits are available in Register 0x01, Bits[1:0].

The available options are as shown in Table 16.

Table 16. Analog Gain Options

PV _{DD}	ANA_GAIN	Amplifier Analog Gain Selection
5 V to 9 V	00	8.4 V full-scale gain mapping
9 V to 13 V	01	12.6 V full-scale gain mapping
13 V to 14 V	10	14 V full-scale gain mapping
14 V to 16 V	11	15 V full-scale gain mapping

There is also a digital gain or volume control that provides fine control in 0.375 dB steps from -70 dB to +24 dB.

POP AND CLICK SUPPRESSION

Voltage transients at the output of audio amplifiers may occur when shutdown is activated or deactivated. Voltage transients as small as 10 mV can be heard as an audible pop in the speaker. Clicks and pops are defined as undesirable audible transients generated by the amplifier system that do not come from the system input signal.

Such transients may be generated when the amplifier system changes its operating mode. For example, system power-up and power-down can be sources of audible transients.

The SSM3515 has a pop and click suppression architecture that reduces these output transients, resulting in noiseless activation and deactivation.

Either mute or power-down must be set before the BCLK is removed to ensure a pop free power-down.

EMI NOISE

The SSM3515 uses a proprietary modulation and spread spectrum technology to minimize EMI emissions from the device. The SSM3515 can pass FCC Class B emissions testing with an unshielded 20-inch cable using ferrite bead-based filtering. For applications that have difficulty passing FCC Class B emission tests, the SSM3515 includes a modulation select pin (ultralow EMI emission mode) that significantly reduces the radiated emissions at the Class-D outputs, particularly above 100 MHz. Note that reducing the supply voltage greatly reduces radiated emissions.

OUTPUT MODULATION DESCRIPTION

The SSM3515 uses three-level, Σ - Δ output modulation. Each output can swing from GND to PV_{DD} and vice versa. Ideally, when no input signal is present, the output differential voltage is 0 V because there is no need to generate a pulse. In a real-world situation, there are always noise sources present.

Due to this constant presence of noise, a differential pulse is occasionally generated in response to this stimulus. A small amount of current flows into the inductive load when the differential pulse is generated. However, most of the time, the output differential voltage is 0 V. This feature ensures that the current flowing through the inductive load is small.

When the user sends an input signal, an output pulse is generated to follow the input voltage. The differential pulse density is increased by raising the input signal level. Figure 66 depicts three-level, Σ - Δ output modulation with and without input stimulus.

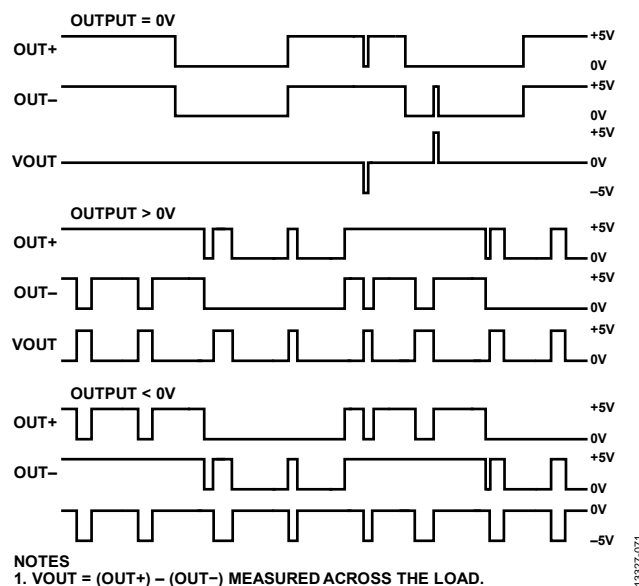

Figure 66. Three-Level, Σ - Δ Output Modulation With and Without Input Stimulus

FAULTS AND LIMITER STATUS REPORTING

The SSM3515 offers comprehensive protections against the faults at the outputs and reporting to help with system design. The faults listed in Table 17 are reported using the status registers.

Table 17. Register 0x0A, Faults

Fault Type	Flag Set Condition	Status Reported Register
5 V Regulator UV	5 V regulator voltage at VREG50/AVDD < 3.6 V	Register 0x0A, Bit 6, UVLO_VREG
Limiters/Gain Reduction Engage	Limiters engaged	Register 0x0A, Bit 5, LIM_EG
Clipping	DAC clipping	Register 0x0A, Bit 4, CLIP
Output Overcurrent (OC)	Output current > 6 A peak	Register 0x0A, Bit 3, AMP_OC
Die Overtemperature (OT)	Die temperature > 145°C	Register 0x0A, Bit 2, OTF
Die Overtemperature Warning (OTW)	Die temperature > 117°C	Register 0x0A, Bit 4, OTW
Battery Voltage > VBAT_INF	Battery voltage PV _{DD} > VBAT_INF	Register 0x0A, Bit 0, BAT_WARN

The faults listed in Table 17 are reported in Register 0x0A and can be read via I²C by the microcontroller in the system.

In the event of a fault occurrence, how the device reacts to the faults can be controlled by using Register 0x0B.

Table 18. Register 0x0B, Fault Recovery

Fault Type	Flag Set Condition	Status Reported Register
OTW	The amount of gain reduction applied if there is an OTW	Register 0x0B, Bits[7:6], OTW_GAIN
Manual Recovery	Use to attempt manual recovery in case of a fault event	Register 0x0B, Bit 5, MRCV
Autorecovery Attempts	When autorecovery from faults is used, set the number of attempts using this bit	Register 0x0B, Bits[4:3], MAX_AR
UV	Recovery can be automatic or manual	Register 0x0B, Bit 2, ARCV_UV
Die OT	Recovery can be automatic or manual	Register 0x0B, Bit 1, ARCV_OT
OC	Recovery can be automatic or manual	Register 0x0B, Bit 0, ARCV_OC

When the automatic recovery mode is set, the device attempts to recover itself after the fault event and, in case the fault persists, then the device sets the fault again. This process repeats until the fault is resolved.

When the manual recovery mode is used, the device shuts down and the recovery must be attempted using the system microcontroller.

VBAT SENSING

The SSM3515 contains an 8-bit ADC that measures the voltage of the battery voltage (VBAT) supply. The battery voltage information is stored in Register 0x06 as an 8-bit unsigned format. The ADC input range is fixed internally as 3.8 V to 16.2 V. To convert the hexadecimal (hex) value to the voltage value, use the following steps:

- Convert the hex value to decimal. For example, if the hex value is 0xA9, the decimal value = 169.
- Calculate the voltage using the following equation:

$$\text{Voltage} = 3.8 \text{ V} + 12.4 \text{ V} \times \text{Decimal Value}/255$$

With a decimal value of 169,

$$\text{Voltage} = 3.8 \text{ V} + 12.4 \text{ V} \times 169/255 = 12.02 \text{ V}$$

LIMITER AND BATTERY TRACKING THRESHOLD CONTROL

The SSM3515 contains an output limiter that can be used to limit the peak output voltage of the amplifier. The limiter works on the rms and peak value of the signal. The limiter threshold, slope, attack rate, and release rate are programmable using Register 0x07, Register 0x08, and Register 0x09. The limiter can be enabled or disabled using LIM_EN, Bits[1:0] in Register 0x07.

The threshold at which the output is limited is determined by the LIM_THRES register setting, in Register 0x08, Bits[7:3]. When the output signal level exceeds the set threshold level, the limiter activates and limits the signal level to the set limit. Below the set threshold, the output level is not affected. The limiter threshold can be set from 1 V peak to 15 V peak.

The limiter threshold can be set above the maximum output voltage of the amplifier. In this case, the limiter allows maximum peak output; in other words, the output may clip depending on the power supply voltage and not the limiter.

The limiter threshold can be set as fixed or to vary with the battery voltage via the VBAT_TRACK bit (Register 0x07, Bit 2). When set to fixed, the limiter threshold is fixed and does not vary with battery voltage. The threshold can be set from 1 V peak to 15 V peak using the LIM_THRES bit (see Figure 68).

When set to a variable threshold, the SSM3515 monitors the VBAT supply and automatically adjusts the limiter threshold based on the VBAT supply voltage.

The VBAT supply voltage at which the limiter threshold level begins to decrease the output level is determined by the VBAT inflection point, the VBAT_INF bits (Register 0x09, Bits[7:0]).

The VBAT_INF point is defined as the battery voltage at which the limiter either activates or deactivates depending on the LIM_EN mode (see Table 19). When the battery voltage is greater than VBAT_INF, the limiter is not active. When it battery voltage is less than VBAT_INF, the limiter is activated. The VBAT_INF bits can be set from 3.8 V to 16.2 V. The 8-bit value for the voltage can be calculated using the following equation.

$$\text{Voltage} = 3.8 + 12.4 \times \text{Decimal Value}/255$$

Convert the decimal value to an 8-bit hex value and use it to set the VBAT_INF bits.

The rate at which the limiter threshold is lowered relative to the amount change in VBAT below the VBAT_INF point is determined by the slope bits (Register 0x08, Bits[1:0]).

The slope is the ratio of the limiter threshold reduction to the VBAT voltage reduction.

$$\text{Slope} = \Delta \text{Limiter Threshold} / \Delta \text{VBAT}$$

The slope ratio can be set from 1:1 to 4:1. This function is useful to prevent early shutdown under low battery conditions. As the VBAT voltage falls, the limiter threshold is lowered. This results in the lower output level and therefore helps to reduce the current drawn from the battery and in turn helps prevent early shutdown due to low VBAT.

The limiter offers various active modes which can be set using the LIM_EN bits (Register 0x07, Bits[1:0]) and the VBAT_TRACK bit, as shown in Table 19.

When LIM_EN = 01, the limiter is enabled. When LIM_EN = 10, the limiter mutes the output if VBAT falls below VBAT_INF. When LIM_EN = 11, the limiter engages only when the battery voltage is lower than VBAT_INF. When VBAT is above VBAT_INF, no limiting occurs. Note that there is hysteresis on VBAT_INF for the limiter disengaging.

The limiter, when active, reduces the gain of the amplifier. The rate of gain reduction or attack rate is determined by the LIM_ATR bits (Register 0x07, Bits[5:4]). Similarly, when the signal level drops below the limiter threshold, the gain is restored. The gain release rate is determined by the LIM_RRT bits (Register 0x07, Bits[7:6]).

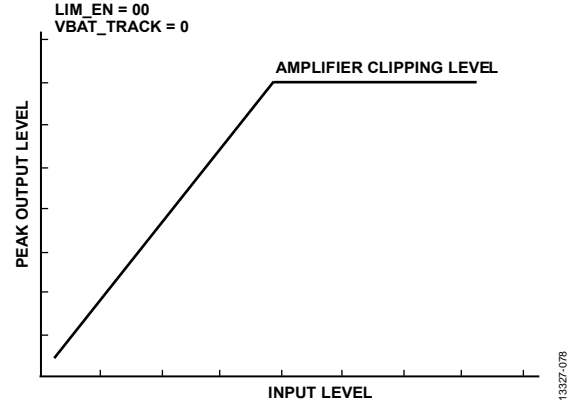

Figure 67. Limiter Example (LIM_EN = 0b0, VBAT_TRACK = 0bx)

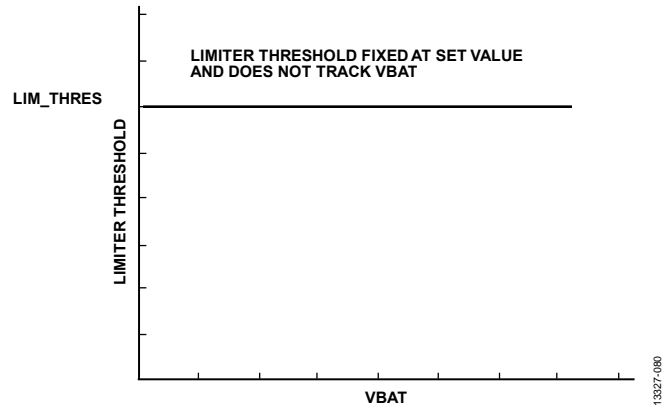

Figure 68. Limiter Fixed (LIM_EN = 0b01, VBAT_TRACK = 0b0)

Table 19. Limiter Modes

LIM_EN	VBAT_TRACK	Limiter	VBAT < VBAT_INF	VBAT > VBAT_INF	Comments
00	0/1	No	Not applicable	Not applicable	See Figure 67
01	0	Fixed	Use the set threshold	Use the set threshold	See Figure 68
01	1	Variable	Lowers the threshold	Use the set threshold	See Figure 69 and Figure 70
10	0/1	Fixed	Mutes the output	Use the set threshold	
11	0	Fixed	Use the set threshold	No limiting	See Figure 71 and Figure 72
11	1	Variable	Lowers the threshold	No limiting	See Figure 73 and Figure 74

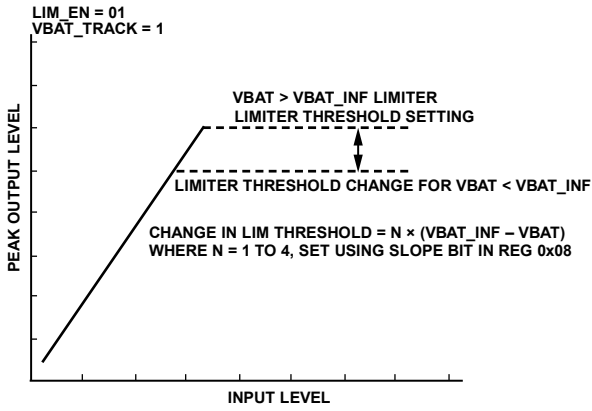

Figure 69. Limiter Fixed (LIM_EN = 0b01, VBAT_TRACK = 0b1)

13327-081

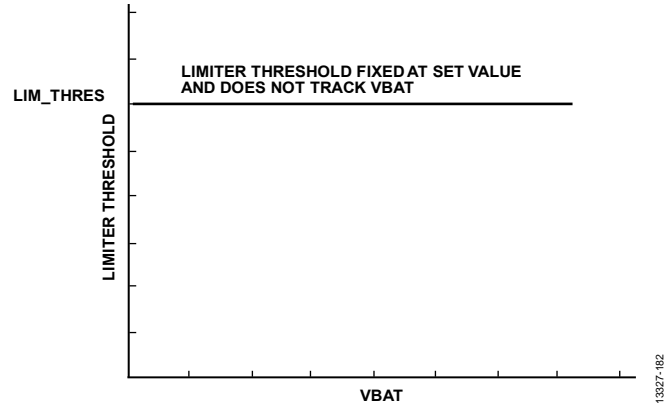

Figure 72. Limiter Fixed (LIM_EN = 0b11, VBAT_TRACK = 0b0)

13327-182

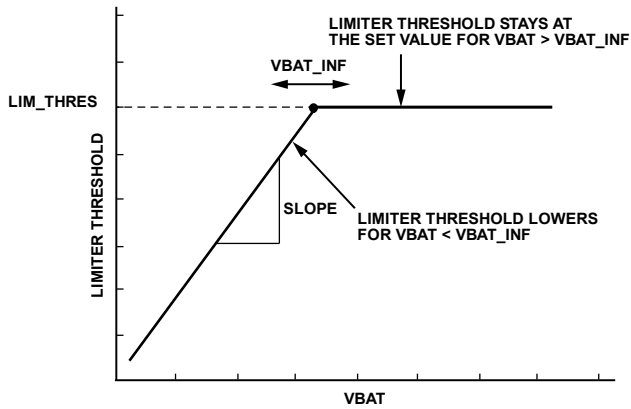

Figure 70. Output Level vs. VBAT in Limiter Tracking Mode (LIM_EN = 0b01, VBAT_TRACK = 0b1)

13327-181

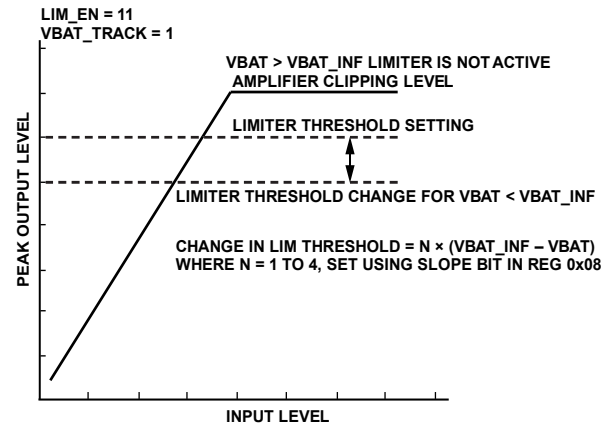

Figure 73. Limiter Example (LIM_EN = 0b11, VBAT_TRACK = 0b1)

13327-083

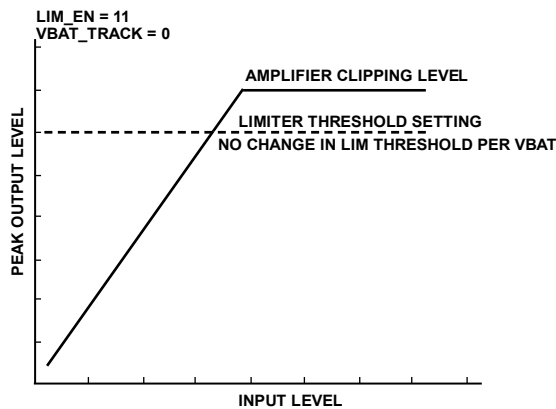

Figure 71. Limiter Example (LIM_EN = 0b11, VBAT_TRACK = 0)

13327-082

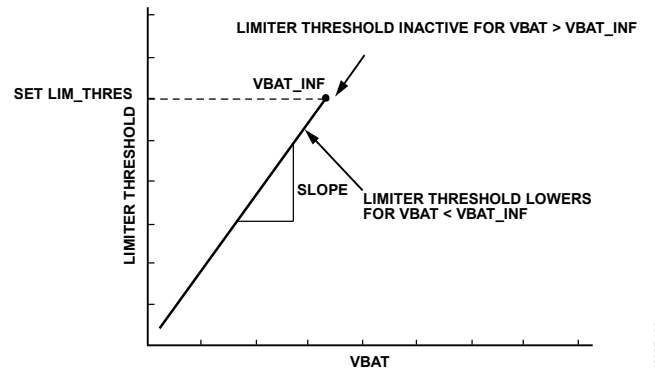

Figure 74. Output Level vs. VBAT in Limiter Tracking Mode (LIM_EN = 0b11, VBAT_TRACK = 0b1)

13327-083

LAYOUT

As output power increases, care must be taken to lay out PCB traces and wires properly among the amplifier, load, and power supply; a poor layout increases voltage drops, consequently decreasing efficiency. A good practice is to use short, wide PCB tracks to decrease voltage drops and minimize inductance. For lowest dc resistance (DCR) and minimum inductance, ensure that track widths are at least 200 mil for every inch of length and use 1 oz or 2 oz copper. Use large traces for the power supply inputs and amplifier outputs. Proper grounding guidelines improve audio performance, minimize crosstalk between channels, and prevent switching noise from coupling into the audio signal.

To maintain high output swing and high peak output power, the PCB traces that connect the output pins to the load and supply pins must be as wide as possible to maintain the minimum trace resistances. It is also recommended that a large ground plane be used for minimum impedances. In addition, good PCB layout isolates critical analog paths from sources of high interference. Separate high frequency circuits (analog and digital) from low frequency circuits.

Properly designed multilayer PCBs can reduce EMI emission and increase immunity to the RF field by a factor of 10 or more, compared with double-sided boards. A multilayer board allows a complete layer to be used for the ground plane, whereas the ground plane side of a double-sided board is often disrupted by signal crossover.

If the system has separate analog and digital ground and power planes, the analog ground plane must be directly beneath the analog power plane, and, similarly, the digital ground plane must be directly beneath the digital power plane. There must be no overlap between analog and digital ground planes or between analog and digital power planes.

BOOTSTRAP CAPACITORS

The output stage of the SSM3515 uses a high-side NMOS driver, rather than PMOS. Therefore, a bootstrap supply is needed to drive the high-side NMOS. To generate the boosted gate driver voltage for the high-side NMOS, a 0.22 μF bootstrap capacitor is used from each output pin to BST \pm pins. This capacitor boosts the voltage at BST \pm pins when the high-side NMOS turns on and acts as a floating power supply for that particular switching cycle. The bootstrap capacitor is charged during the low-side NMOS active period.

POWER SUPPLY DECOUPLING

To ensure high efficiency, low total harmonic distortion (THD), and high power supply rejection ratio (PSRR), proper power supply decoupling is necessary. Noise transients on the power supply lines are short duration voltage spikes. These spikes can contain frequency components that extend into the hundreds of megahertz. The power supply input must be decoupled with a good quality, low ESL, low ESR bulk capacitor larger than 220 μF . This capacitor bypasses low frequency noises to the ground plane.

For high frequency transient noises, place 1 μF capacitors as close as possible to the PVDD pins of the device.

REGISTER SUMMARY

Table 20. Register Summary

Reg.	Name	Bits	Bit 7	Bit 6	Bit 5	Bit 4	Bit 3	Bit 2	Bit 1	Bit 0	Reset	RW	
0x00	Power Control	[7:0]	APWDN_EN	BSNS_PWDN	RESERVED				S_RST	SPWDN	0x81	R/W	
0x01	Gain and Edge Control	[7:0]	RESERVED			EDGE	RESERVED		ANA_GAIN		0x01	R/W	
0x02	DAC Control	[7:0]	DAC_HV	DAC_MUTE	DAC_HPF	DAC_LPM	RESERVED	DAC_FS			0x32	R/W	
0x03	DAC Volume Control	[7:0]	VOL									0x40	R/W
0x04	SAI Control 1	[7:0]	DAC_POL	BCLK_POL	TDM_BCLKS			FSYNC_MODE	SDATA_FMT	SAI_MODE	0x11	R/W	
0x05	SAI Control 2	[7:0]	DATA_WIDTH	RESERVED		AUTO_SLOT	TDM_SLOT				0x00	R/W	
0x06	Battery Voltage Output	[7:0]	VBAT									0x00	R
0x07	Limiter Control 1	[7:0]	LIM_RRT		LIM_ATR		RESERVED	VBAT_TRACK	LIM_EN		0xA4	R/W	
0x08	Limiter Control 2	[7:0]	LIM_THRES					RESERVED	SLOPE		0x51	R/W	
0x09	Limiter Control 3	[7:0]	VBAT_INF									0x22	R/W
0x0A	Status	[7:0]	RESERVED	UVLO_VREG	LIM_EG	CLIP	AMP_OC	OTF	OTW	BAT_WARN	0x00	R	
0x0B	Fault Control	[7:0]	OTW_GAIN		MRCV	MAX_AR		ARCV_UV	ARCV_OT	ARCV_OC	0x18	R/W	

REGISTER DETAILS

POWER CONTROL REGISTER

Address: 0x00, Reset: 0x81, Name: Power Control

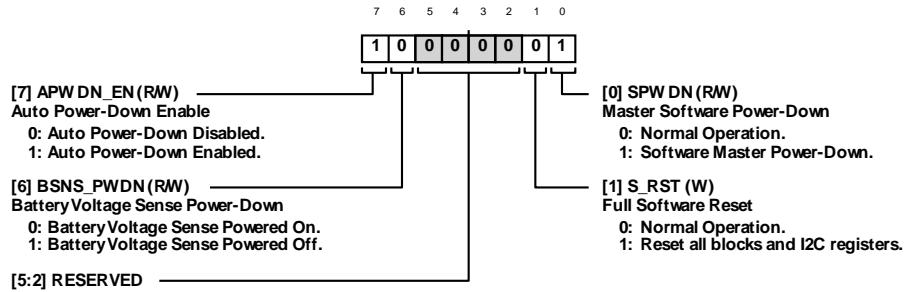

Table 21. Bit Descriptions for Power Control

Bits	Bit Name	Settings	Description	Reset	Access
7	APWDN_EN	0 1	Auto Power-Down Enable. Auto power-down automatically puts the IC in a low power state when 2048 consecutive zero input samples have been received. Auto Power-Down Disabled. Auto Power-Down Enabled. When APWDN_EN = 1 the device automatically powers down when 2048 consecutive zero value input samples have been received. The device automatically powers up when a single nonzero sample is received.	0x1	R/W
6	BSNS_PWDN	0 1	Battery Voltage Sense Power-Down. Battery Voltage Sense Powered On. Battery Voltage Sense Powered Off.	0x0	R/W
[5:2]	RESERVED		Reserved.	0x0	R/W
1	S_RST	0 1	Full Software Reset. Normal Operation. Reset all Blocks and I ² C Registers.	0x0	W
0	SPWDN	0 1	Master Software Power-Down. Software power-down puts all blocks except the I ² C interface in a low-power state. Normal Operation. Software Master Power-Down.	0x1	R/W

GAIN AND EDGE CONTROL REGISTER

Address: 0x01, Reset: 0x01, Name: Gain and Edge Control

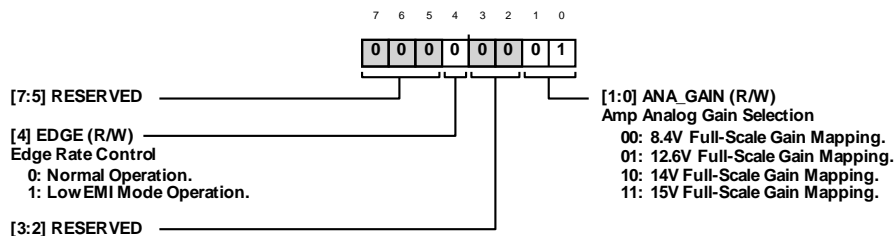

Table 22. Bit Descriptions for Gain and Edge Control

Bits	Bit Name	Settings	Description	Reset	Access
[7:5]	RESERVED		Reserved.	0x0	R/W

Bits	Bit Name	Settings	Description	Reset	Access
4	EDGE	0 1	Edge Rate Control. This controls the edge speed of the power stage. The low EMI operation mode reduces the edge speed, lowering EMI and power efficiency Normal Operation. Low EMI Mode Operation.	0x0	R/W
[3:2]	RESERVED		Reserved.	0x0	R/W
[1:0]	ANA_GAIN	00 01 10 11	Amp Analog Gain Selection. 8.4 V Full-Scale Gain Mapping. 12.6 V Full-Scale Gain Mapping. 14 V Full-Scale Gain Mapping. 15 V Full-Scale Gain Mapping.	0x1	R/W

DAC CONTROL REGISTER

Address: 0x02, Reset: 0x32, Name: DAC Control

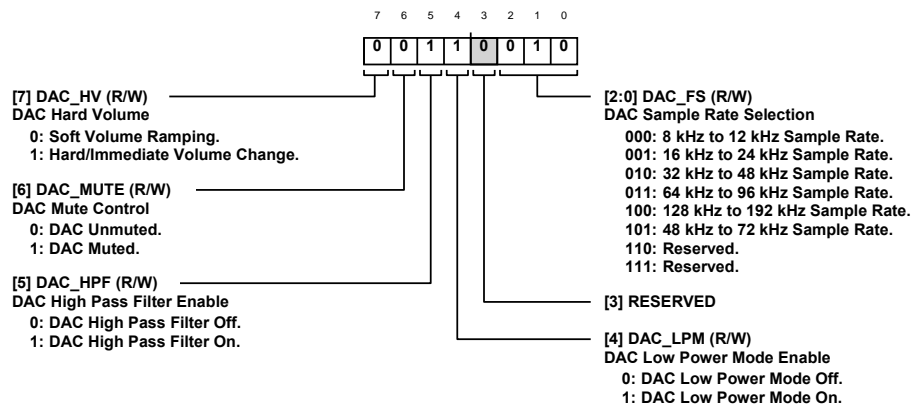

Table 23. Bit Descriptions for DAC Control

Bits	Bit Name	Settings	Description	Reset	Access
7	DAC_HV	0 1	DAC Hard Volume. Soft Volume Ramping. Hard/Immediate Volume Change.	0x0	R/W
6	DAC_MUTE	0 1	DAC Mute Control. DAC Unmuted. DAC Muted.	0x0	R/W
5	DAC_HPF	0 1	DAC High-Pass Filter Enable. DAC High-Pass Filter Off. DAC High-Pass Filter On.	0x1	R/W
4	DAC_LPM	0 1	DAC Low Power Mode Enable. DAC Low Power Mode Off. DAC Low Power Mode On.	0x1	R/W
3	RESERVED		Reserved.	0x0	R/W

Bits	Bit Name	Settings	Description	Reset	Access
[2:0]	DAC_FS		DAC Sample Rate Selection.	0x2	R/W
		000	8 kHz to 12 kHz Sample Rate.		
		001	16 kHz to 24 kHz Sample Rate.		
		010	32 kHz to 48 kHz Sample Rate.		
		011	64 kHz to 96 kHz Sample Rate.		
		100	128 kHz to 192 kHz Sample Rate.		
		101	48 kHz to 72 kHz Sample Rate.		
		110	Reserved.		
		111	Reserved.		

DAC VOLUME CONTROL REGISTER

Address: 0x03, Reset: 0x40, Name: DAC Volume Control

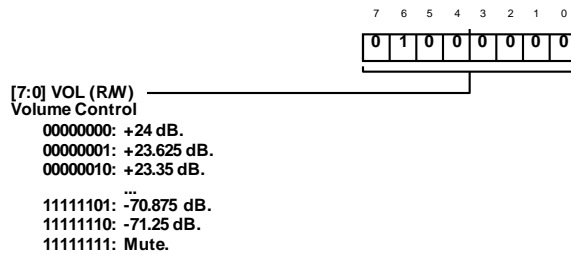

Table 24. Bit Descriptions for DAC Volume Control

Bits	Bit Name	Settings	Description	Reset	Access
[7:0]	VOL		Volume Control.	0x40	R/W
		00000000	+24 dB.		
		00000001	+23.625 dB.		
		00000010	+23.35 dB.		
		00000011	+22.875 dB.		
		00000100	+22.5 dB.		
		00000101	...		
		00111111	+0.375 dB.		
		01000000	0.		
		01000001	-0.375 dB.		
		01000010	...		
		11111101	-70.875 dB.		
		11111110	-71.25 dB.		
		11111111	Mute.		

SAI CONTROL 1 REGISTER

Address: 0x04, Reset: 0x11, Name: SAI Control 1

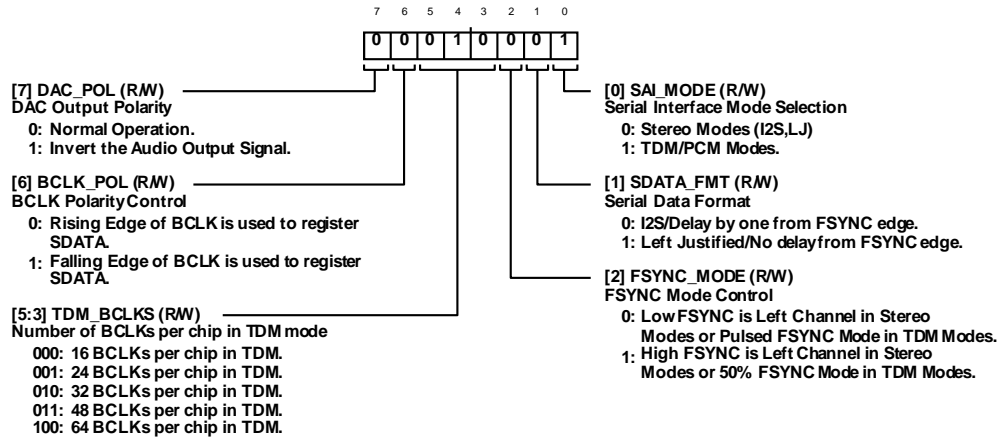
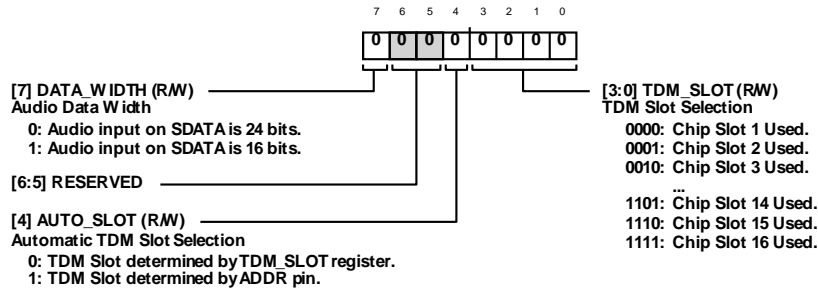

Table 25. Bit Descriptions for SAI Control 1

Bits	Bit Name	Settings	Description	Reset	Access
7	DAC_POL	0 1	DAC Output Polarity. Normal Operation. Invert the Audio Output Signal.	0x0	R/W
6	BCLK_POL	0 1	BCLK Polarity Control. Rising Edge of BCLK is Used to Register SDATA. Falling Edge of BCLK is Used to Register SDATA.	0x0	R/W
[5:3]	TDM_BCLKS	000 001 010 011 100	Number of BCLKs per Chip in TDM Mode. Any number of BCLK cycles per FSYNC can be used in stereo modes (I2S/LJ) or in TDM mode with only one chip. When in TDM mode and having multiple chips on the TDM bus, the number of BCLKs per chip must be defined. 16 BCLKs per Chip in TDM. 24 BCLKs per Chip in TDM. 32 BCLKs per Chip in TDM. 48 BCLKs per Chip in TDM. 64 BCLKs per Chip in TDM.	0x2	R/W
2	FSYNC_MODE	0 1	FSYNC Mode Control. Low FSYNC is Left Channel in Stereo Modes or Pulsed FSYNC Mode in TDM Modes. High FSYNC is Left Channel in Stereo Modes or 50% FSYNC Mode in TDM Modes.	0x0	R/W
1	SDATA_FMT	0 1	Serial Data Format. I2S/Delay by One from FSYNC Edge. Left Justified/No Delay from FSYNC Edge.	0x0	R/W
0	SAI_MODE	0 1	Serial Interface Mode Selection. Stereo Modes (I2S, LJ). TDM/PCM Modes.	0x1	R/W

SAI CONTROL 2 REGISTER

Address: 0x05, Reset: 0x00, Name: SAI Control 2

**Table 26. Bit Descriptions for SAI Control 2**

Bits	Bit Name	Settings	Description	Reset	Access
7	DATA_WIDTH	0 1	Audio Data Width. 0 Audio Input on SDATA is 24 Bits. 1 Audio Input on SDATA is 16 Bits.	0x0	R/W
[6:5]	RESERVED		Reserved.	0x0	R/W
4	AUTO_SLOT	0 1	Automatic TDM Slot Selection. 0 TDM Slot Determined by the TDM_SLOT Register. 1 TDM Slot Determined by the ADDR Pin.	0x0	R/W
[3:0]	TDM_SLOT	0000 0001 0010 0011 0100 0101 0110 0111 1000 1001 1010 1011 1100 1101 1110 1111	TDM Slot Selection. Chip Slot 1 Used. Chip Slot 2 Used. Chip Slot 3 Used. Chip Slot 4 Used. Chip Slot 5 Used. Chip Slot 6 Used. Chip Slot 7 Used. Chip Slot 8 Used. Chip Slot 9 Used. Chip Slot 10 Used. Chip Slot 11 Used. Chip Slot 12 Used. Chip Slot 13 Used. Chip Slot 14 Used. Chip Slot 15 Used. Chip Slot 16 Used.	0x0	R/W

BATTERY VOLTAGE OUTPUT REGISTER

Address: 0x06, Reset: 0x00, Name: Battery Voltage Output

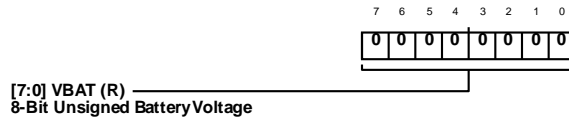

Table 27. Bit Descriptions for Battery Voltage Output

Bits	Bit Name	Settings	Description	Reset	Access
[7:0]	VBAT		8-Bit Unsigned Battery Voltage	0x0	R

LIMITER CONTROL 1 REGISTER

Address: 0x07, Reset: 0xA4, Name: Limiter Control 1

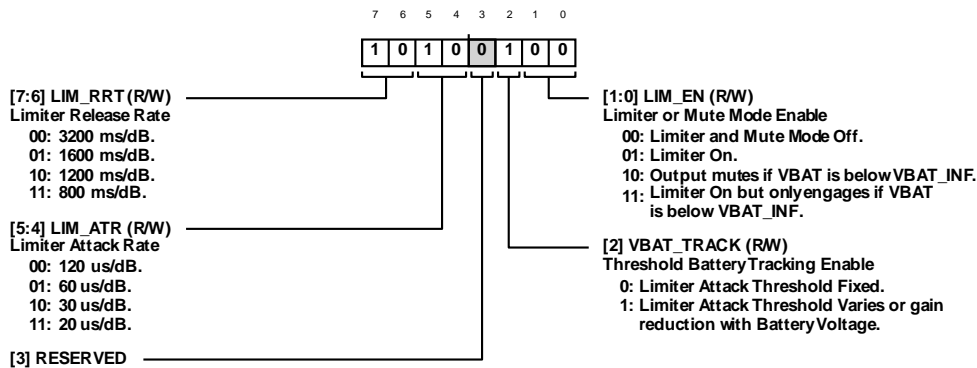

Table 28. Bit Descriptions for Limiter Control 1

Bits	Bit Name	Settings	Description	Reset	Access
[7:6]	LIM_RRT	00 01 10 11	Limiter Release Rate. 3200 ms/dB. 1600 ms/dB. 1200 ms/dB. 800 ms/dB.	0x2	R/W
[5:4]	LIM_ATR	00 01 10 11	Limiter Attack Rate. 120 μs/dB. 60 μs/dB. 30 μs/dB. 20 μs/dB.	0x2	R/W
3	RESERVED		Reserved.	0x0	R/W
2	VBAT_TRACK	0 1	Threshold Battery Tracking Enable. 0 Limiter Attack Threshold Fixed. 1 Limiter Attack Threshold Varies or Gain Reduction with Battery Voltage.	0x1	R/W
[1:0]	LIM_EN	00 01 10 11	Limiter or Mute Mode Enable. 00 Limiter and Mute Mode Off. 01 Limiter On. 10 Output Mutes if VBAT is Below VBAT_INF. 11 Limiter On But Only Engages if VBAT is Below VBAT_INF.	0x0	R/W

LIMITER CONTROL 2 REGISTER

Address: 0x08, Reset: 0x51, Name: Limiter Control 2

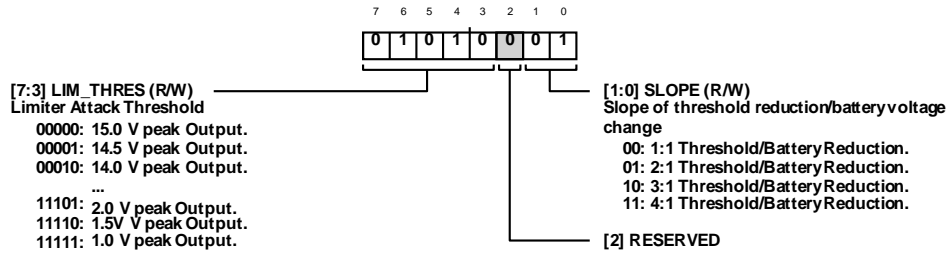

Table 29. Bit Descriptions for Limiter Control 2

Bits	Bit Name	Settings	Description	Reset	Access
[7:3]	LIM_THRES		Limiter Attack Threshold.	0xA	R/W
		00000	15.0 V peak Output.		
		00001	14.5 V peak Output.		
		00010	14.0 V peak Output.		
		00011	13.5 V peak Output.		
		00100	13.0 V peak Output.		
		00101	12.5 V peak Output.		
		00110	12.0 V peak Output.		
		00111	11.5 V peak Output.		
		01000	11.0 V peak Output.		
		01001	10.5 V peak Output.		
		01010	10.0 V peak Output.		
		01011	9.5 V peak Output.		
		01100	9.0 V peak Output.		
		01101	8.5 V peak Output.		
		01110	8.25 V peak Output.		
		01111	8.0 V peak Output.		
		10000	7.75 V peak Output.		
		10001	7.5 V peak Output.		
		10010	7.25 V peak Output.		
		10011	7.0 V peak Output.		
		10100	6.5 V peak Output.		
		10101	6.0 V peak Output.		
		10110	5.5 V peak Output.		
		10111	5.0 V peak Output.		
		11000	4.5 V peak Output.		
		11001	4.0 V peak Output.		
		11010	3.5 V peak Output.		
		11011	3.0 V peak Output.		
		11100	2.5 V peak Output.		
		11101	2.0 V peak Output.		
		11110	1.5 V peak Output.		
		11111	1.0 V peak Output.		

Bits	Bit Name	Settings	Description	Reset	Access
2	RESERVED		Reserved.	0x0	R/W
[1:0]	SLOPE	00 01 10 11	Slope of Threshold Reduction/Battery Voltage Change. 1:1 Threshold/Battery Reduction. 2:1 Threshold/Battery Reduction. 3:1 Threshold/Battery Reduction. 4:1 Threshold/Battery Reduction.	0x1	R/W

LIMITER CONTROL 3 REGISTER

Address: 0x09, Reset: 0x22, Name: Limiter Control 3

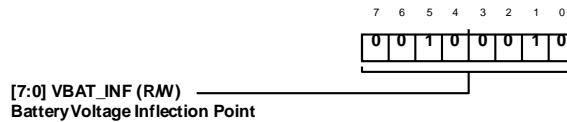

Table 30. Bit Descriptions for Limiter Control 3

Bits	Bit Name	Settings	Description	Reset	Access
[7:0]	VBAT_INF		Battery Voltage Inflection Point. This is the VBAT sense value at which the limiter either activates or starts reducing the threshold. It corresponds to the value that can be read in the VBAT read only status register. To calculate this value in volts, refer to the VBAT Sensing section. $Voltage = 3.8 + 12.4 \times Decimal\ Value / 255$.	0x22	R/W

STATUS REGISTER

Address: 0x0A, Reset: 0x00, Name: Status

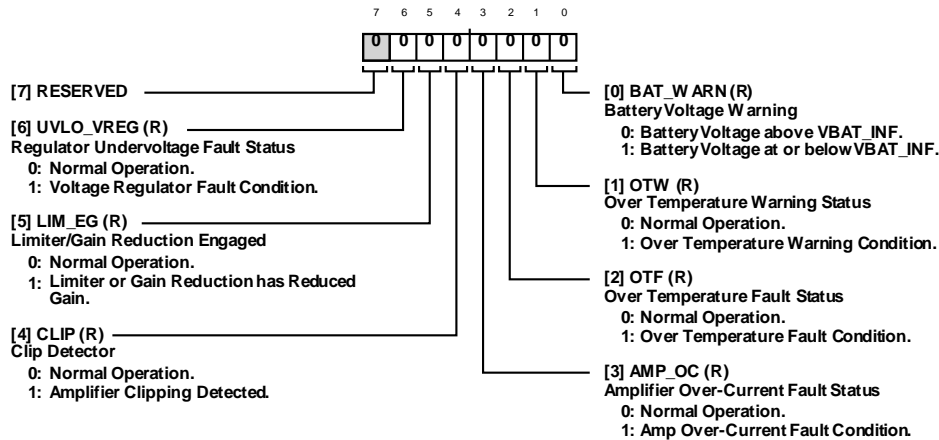

Table 31. Bit Descriptions for Status

Bits	Bit Name	Settings	Description	Reset	Access
7	RESERVED		Reserved.	0x0	R
6	UVLO_VREG	0 1	Regulator Undervoltage Fault Status. Normal Operation. Voltage Regulator Fault Condition.	0x0	R
5	LIM_EG	0 1	Limiter/Gain Reduction Engaged. Normal Operation. Limiter or Gain Reduction has Reduced Gain.	0x0	R

Bits	Bit Name	Settings	Description	Reset	Access
4	CLIP	0 1	Clip Detector. Normal Operation. Amplifier Clipping Detected.	0x0	R
3	AMP_OC	0 1	Amplifier Overcurrent Fault Status. Normal Operation. Amp Over-Current Fault Condition.	0x0	R
2	OTF	0 1	Overtemperature Fault Status. Normal Operation. Overtemperature Fault Condition.	0x0	R
1	OTW	0 1	Overtemperature Warning Status. Normal Operation. Overtemperature Warning Condition.	0x0	R
0	BAT_WARN	0 1	Battery Voltage Warning. Battery Voltage Above VBAT_INF. Battery Voltage at or Below VBAT_INF.	0x0	R

FAULT CONTROL REGISTER

Address: 0x0B, Reset: 0x18, Name: Fault Control

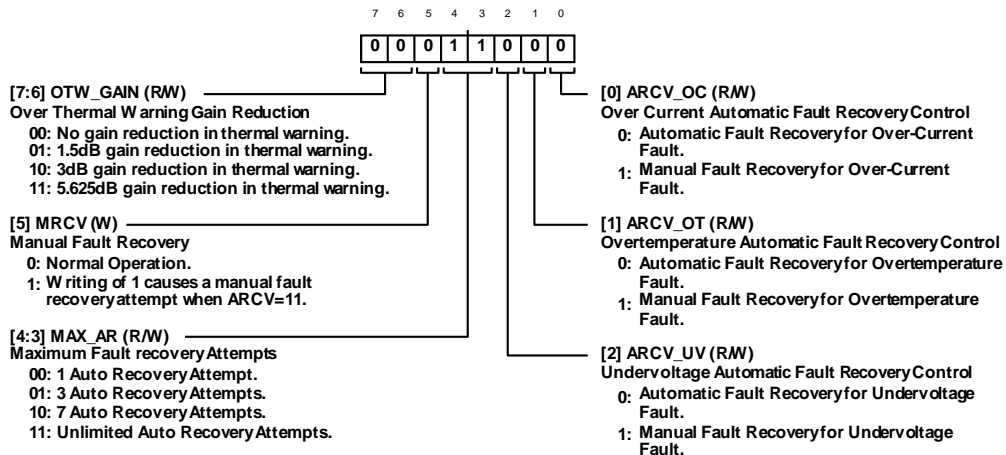

Table 32. Bit Descriptions for Fault Control

Bits	Bit Name	Settings	Description	Reset	Access
[7:6]	OTW_GAIN	00 01 10 11	Over Thermal Warning Gain Reduction. No Gain Reduction in Thermal Warning. 1.5 dB Gain Reduction in Thermal Warning. 3 dB Gain Reduction in Thermal Warning. 5.625 dB Gain Reduction in Thermal Warning.	0x0	R/W
5	MRCV	0 1	Manual Fault Recovery. Normal Operation. Writing of 1 Causes a Manual Fault Recovery Attempt when ARCV = 11.	0x0	W

Bits	Bit Name	Settings	Description	Reset	Access
[4:3]	MAX_AR	00 01 10 11	Maximum Fault Recovery Attempts. The maximum autorecovery register determines how many attempts at autorecovery are performed. 1 Autorecovery Attempt. 3 Autorecovery Attempts. 7 Autorecovery Attempts. Unlimited Autorecovery Attempts.	0x3	R/W
2	ARCV_UV	0 1	Undervoltage Automatic Fault Recovery Control. Automatic Fault Recovery for Undervoltage Fault. Manual Fault Recovery for Undervoltage Fault.	0x0	R/W
1	ARCV_OT	0 1	Overtemperature Automatic Fault Recovery Control. Automatic Fault Recovery for Overtemperature Fault. Manual Fault Recovery for Overtemperature Fault.	0x0	R/W
0	ARCV_OC	0 1	Overcurrent Automatic Fault Recovery Control. Automatic Fault Recovery for Overcurrent Fault. Manual Fault Recovery for Overcurrent Fault.	0x0	R/W

TYPICAL APPLICATION CIRCUIT

Figure 75 shows a typical application circuit for a single channel output.

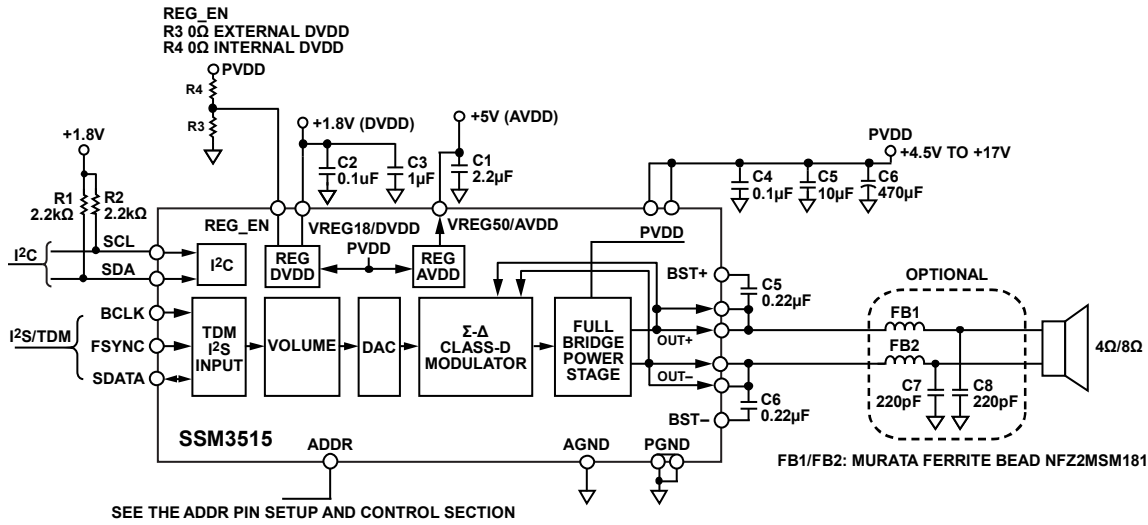

Figure 75. Typical Application Circuit for Single Channel Output

13327-184

OUTLINE DIMENSIONS

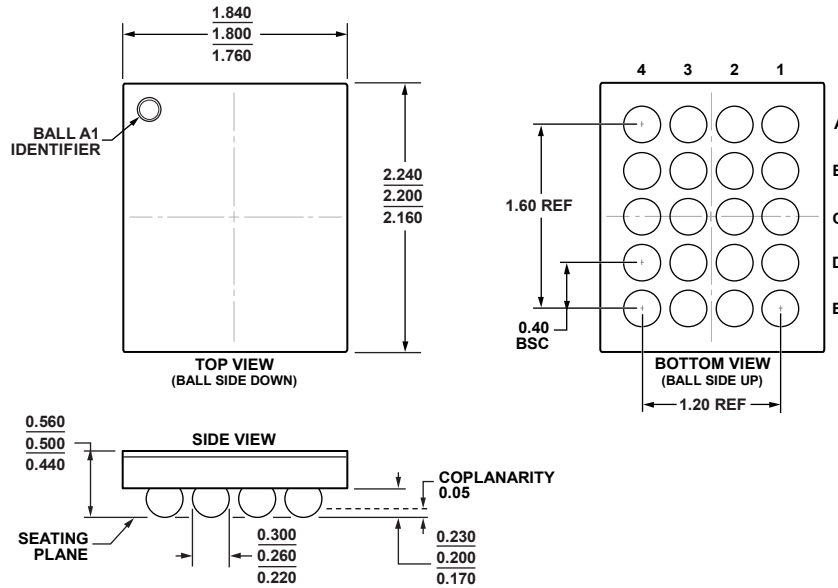

Figure 76. 20-Ball Wafer Level Chip Scale Package [WLCSP]
(CB-20-10)
Dimensions shown in millimeters

12-19-2012-A

ORDERING GUIDE

Model ¹	Temperature Range	Package Description	Package Option
SSM3515CCBZ-RL	-40°C to +85°C	20-Ball Wafer Level Chip Scale Package [WLCSP]	CB-20-10
SSM3515CCBZ-R7	-40°C to +85°C	20-Ball Wafer Level Chip Scale Package [WLCSP]	CB-20-10
EVAL-SSM3515Z		Evaluation Board	

¹ Z = RoHS Compliant Part.

I²C refers to a communications protocol originally developed by Philips Semiconductors (now NXP Semiconductors).

Mouser Electronics

Authorized Distributor

Click to View Pricing, Inventory, Delivery & Lifecycle Information:

[Analog Devices Inc.:](#)

[EVAL-SSM3515Z](#) [SSM3515CCBZ-RL](#) [SSM3515CCBZ-R7](#)