

Approximate Performance in Laboratory Tests

Tensile Strength: 3900 N
Direct Torque: 2 Nm
Body Torque: 0.5 Nm
Shear Strength: 900 N

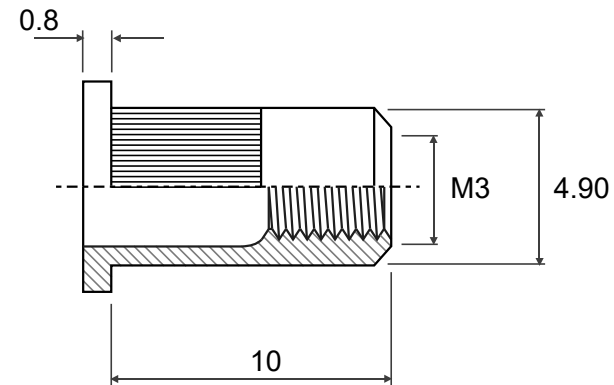

	Material		Customer Part No.	
	Finish		Web Ref No	