

# UL(AC), DL(DC) Series

## UL489 Miniature Molded Case Circuit Breakers

- Available in AC and DC models
- DIN Rail Mounted
- 17.5mm width
- Thermal Magnetic
- 240V, 480Y/277V AC, 50/60Hz
- 125V DC (1 pole); 250V DC (2 pole)
- 10kA Short Circuit Interrupting Capacity
- HACR Type 40°C
- Line/Load reversible



IEC 60947-2  
Short Circuit Tested

### Current/ Voltage Rating

**UL-Series** 0.3 - 63A/ 240V AC, 0.3-32A/ 480Y/277V AC\* (48V DC / pole pending)

**DL-Series** 0.3 - 63A/ 125/ 250V DC

**Calibration Temperature** 40°C (104°F)

**Ambient Temperature** -25°C to +55°C (-13°F to 131°F)

**Storage Temperature** -40°C to +70°C (-40°F to 158°F)

**Terminal Size Acceptability** Top: 18-3 AWG; Bottom: 18-2 AWG

**Terminal Torque (min/max)** 2 Nm (17.7 lb.in.) / 2.5Nm (22.2 lb.in)

**Electrical Life** 6,000 switching cycles ON/ OFF

**Mechanical Life** 10,000 switching cycles ON/ OFF

**Vibration Resistance** > 15g according to DIN EN 60069-2-59 during a load with  $I_1 = 1.05 \times I_N$

**Resistance to mechanical shocks** 25g @ 11ms

**Degree of protection acc. IEC/EN 60529** IP20

**Mounting Orientation** In any plane

\*One device, dual voltage ratings.

### Short Circuit Interrupting Capacity According to UL 489

Poles	Type	0.3-32A	40-63A
1	AC	10kA @ 120, 240, 277V	10kA @ 120, 240V
2-3	AC	10kA @ 120, 240, 480Y/277V	10kA @ 120 240V

Poles	Type	0.3-32A	40-63A
1	DC	10kA @ 125V	10kA @ 125V
2	DC	10kA @ 250V	10kA @ 250V

### Short Circuit Interrupting Capacity According to IEC 60947-2, DIN EN 60947-2

Poles	Type	0.3-32	40-63A
1	AC	15kA@240V	15kA@240V
2-3	AC	15kA@415V	10kA@415V

## Marking Details



## Dimensions in mm

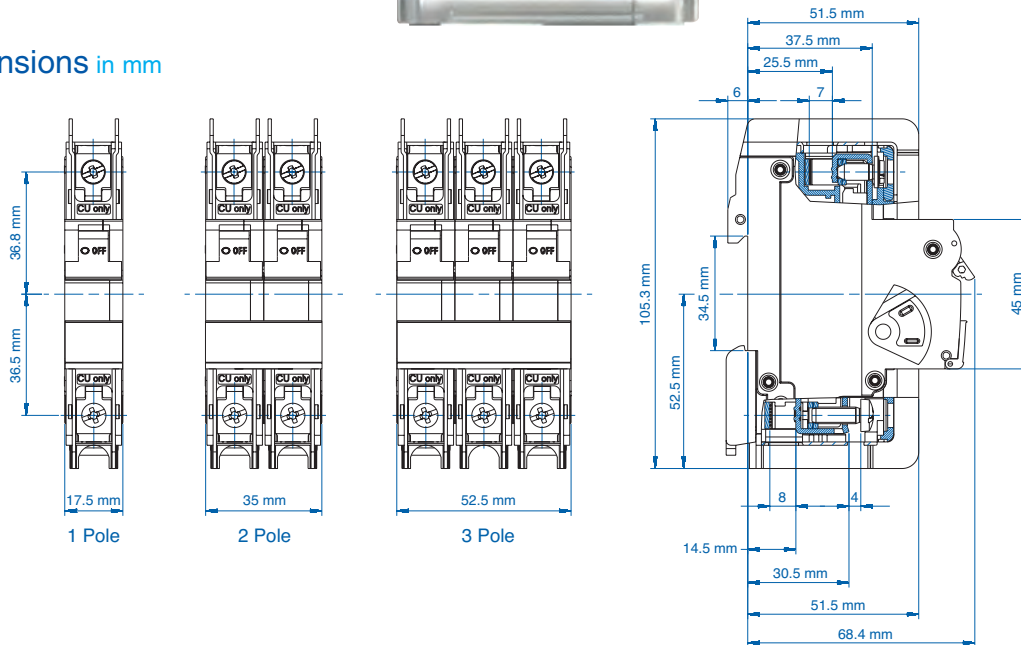

Trip-Characteristics*				Applications								
Characteristic Trip Boundaries				Lighting Wiring Protection Control Circuits	Business Equipment Appliances	Transformers	Power Supplies Heaters	Motors		Reactive Load	Telecommu- nications/ Computer Equipment	Power Supplies
Thermal Trip		Magnetic Trip						Low Inrush	High Inrush			
Must not Trip >100ms	Must Trip <1hr	Must not Trip >100ms	Must Trip at 100ms									
C-Characteristics AC												
1.05xRC	1.35xRC	5xRC	10xRC									
C-Characteristics DC												
1.05xRC	1.35xRC	7xRC	14xRC									
D-Characteristics AC												
1.05xRC	1.35xRC	10xRC	16xRC									
D-Characteristics DC												
1.05xRC	1.35xRC	14xRC	22.4xRC									

\*The value of each characteristic is shown vertically beneath its corresponding heading.



### Warning!

This information should only be used as a selection guide. The use of a Miniature Circuit Breaker in an application with a certain Trip-Characteristic always requires prototype testing! It is the responsibility of the circuit design engineer to select the appropriate Miniature Circuit Breaker for his specific application.

UL 489

UL 508

UL 1077

UL 1077  
Equipment Breakers

Earth Leakage  
Circuit Breakers

ANNEX

# UL - Series

## C-Trip Characteristic



### Application Examples:

Low inrush motors, resistive loads, wiring protection, receptacles, lighting, and control circuit applications. Relatively short thermal trip delay and medium magnetic trip point.



### One Pole

Rated Current	Type/ Cat. No.	Rated Voltage
0.3A	1C03UL	277V AC
0.5A	1C05UL	277V AC
1.0A	1C1UL	277V AC
1.6A	1C1.6UL	277V AC
2.0A	1C2UL	277V AC
3.0A	1C3UL	277V AC
4.0A	1C4UL	277V AC
5.0A	1C5UL	277V AC
6.0A	1C6UL	277V AC
8.0A	1C8UL	277V AC
10A	1C10UL	277V AC
12A	1C12UL	277V AC
13A	1C13UL	277V AC
15A	1C15UL	277V AC
16A	1C16UL	277V AC
20A	1C20UL	277V AC
25A	1C25UL	277V AC
30A	1C30UL	277V AC
32A	1C32UL	277V AC
40A	1C40UL	240V AC
50A	1C50UL	240V AC
60A	1C60UL	240V AC
63A	1C63UL	240V AC

Standard Pack: 12

Weight:  
0.3-32A:  
1.74kg (3.83lb.)  
40-63A:  
1.98kg (4.37lb.)



### Three Pole

Rated Current	Type/ Cat. No.	Rated Voltage
0.3A	3C03UL	480Y/277V AC
0.5A	3C05UL	480Y/277V AC
1.0A	3C1UL	480Y/277V AC
1.6A	3C1.6UL	480Y/277V AC
2.0A	3C2UL	480Y/277V AC
3.0A	3C3UL	480Y/277V AC
4.0A	3C4UL	480Y/277V AC
5.0A	3C5UL	480Y/277V AC
6.0A	3C6UL	480Y/277V AC
8.0A	3C8UL	480Y/277V AC
10A	3C10UL	480Y/277V AC
12A	3C12UL	480Y/277V AC
13A	3C13UL	480Y/277V AC
15A	3C15UL	480Y/277V AC
16A	3C16UL	480Y/277V AC
20A	3C20UL	480Y/277V AC
25A	3C25UL	480Y/277V AC
30A	3C30UL	480Y/277V AC
32A	3C32UL	480Y/277V AC
40A	3C40UL	240V AC
50A	3C50UL	240V AC
60A	3C60UL	240V AC
63A	3C63UL	240V AC

Standard Pack: 4

Weight:  
0.3-32A:  
1.74kg (3.83lb.)  
40-63A:  
1.98kg (4.37lb.)



### Two Pole

Rated Current	Type/ Cat. No.	Rated Voltage
0.3A	2C03UL	480Y/277V AC
0.5A	2C05UL	480Y/277V AC
1.0A	2C1UL	480Y/277V AC
1.6A	2C1.6UL	480Y/277V AC
2.0A	2C2UL	480Y/277V AC
3.0A	2C3UL	480Y/277V AC
4.0A	2C4UL	480Y/277V AC
5.0A	2C5UL	480Y/277V AC
6.0A	2C6UL	480Y/277V AC
8.0A	2C8UL	480Y/277V AC
10A	2C10UL	480Y/277V AC
12A	2C12UL	480Y/277V AC
13A	2C13UL	480Y/277V AC
15A	2C15UL	480Y/277V AC
16A	2C16UL	480Y/277V AC
20A	2C20UL	480Y/277V AC
25A	2C25UL	480Y/277V AC
30A	2C30UL	480Y/277V AC
32A	2C32UL	480Y/277V AC
40A	2C40UL	240V AC
50A	2C50UL	240V AC
60A	2C60UL	240V AC
63A	2C63UL	240V AC

Standard Pack: 6

Weight:  
0.3-32A:  
1.74kg (3.83lb.)  
40-63A:  
1.98kg (4.37lb.)



### Add-on Neutral Pole

Rated Current	Type/ Cat. No.	Rated Voltage
0.3-32A	N32UL	480/277V AC
40-63A	N63UL	240V AC

Standard Pack: 6

Weight:  
0.99kg (2.18 lb.)

### Standard Dual Connection Terminal

- Box clamp terminals  
Top: 18-3 AWG;  
Bottom: 18-2 AWG  
(Line/Load reversible)
- Ring tongue terminals

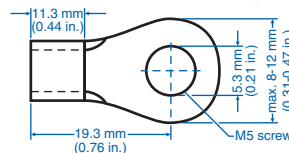
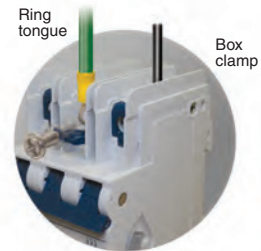

\* May differ by manufacturer. Top terminal ring tongue max. thickness 1.6mm.

**UL - Series**

**D-Trip  
Characteristic**



**Application Examples:**

High inrush motors, transformers, power supplies, heaters and reactive loads. Relatively long thermal trip delay and very high magnetic trip point.

**One Pole**



Rated Current	Type/ Cat. No.	Rated Voltage
0.3A	1D03UL	277V AC
0.5A	1D05UL	277V AC
1.0A	1D1UL	277V AC
1.6A	1D1.6UL	277V AC
2.0A	1D2UL	277V AC
3.0A	1D3UL	277V AC
4.0A	1D4UL	277V AC
5.0A	1D5UL	277V AC
6.0A	1D6UL	277V AC
8.0A	1D8UL	277V AC
10A	1D10UL	277V AC
12A	1D12UL	277V AC
13A	1D13UL	277V AC
15A	1D15UL	277V AC
16A	1D16UL	277V AC
20A	1D20UL	277V AC
25A	1D25UL	277V AC
30A	1D30UL	277V AC
32A	1D32UL	277V AC
40A	1D40UL	240V AC
50A	1D50UL	240V AC
60A	1D60UL	240V AC
63A	1D63UL	240V AC

Standard Pack: 12

Weight:  
0.3-32A:  
1.74kg (3.83lb.)  
40-63A:  
1.98kg (4.37lb.)

**Three Pole**



Rated Current	Type/ Cat. No.	Rated Voltage
0.3A	3D03UL	480Y/277V AC
0.5A	3D05UL	480Y/277V AC
1.0A	3D1UL	480Y/277V AC
1.6A	3D1.6UL	480Y/277V AC
2.0A	3D2UL	480Y/277V AC
3.0A	3D3UL	480Y/277V AC
4.0A	3D4UL	480Y/277V AC
5.0A	3D5UL	480Y/277V AC
6.0A	3D6UL	480Y/277V AC
8.0A	3D8UL	480Y/277V AC
10A	3D10UL	480Y/277V AC
12A	3D12UL	480Y/277V AC
13A	3D13UL	480Y/277V AC
15A	3D15UL	480Y/277V AC
16A	3D16UL	480Y/277V AC
20A	3D20UL	480Y/277V AC
25A	3D25UL	480Y/277V AC
30A	3D30UL	480Y/277V AC
32A	3D32UL	480Y/277V AC
40A	3D40UL	240V AC
50A	3D50UL	240V AC
60A	3D60UL	240V AC
63A	3D63UL	240V AC

Standard Pack: 4

Weight:  
0.3-32A:  
1.74kg (3.83lb.)  
40-63A:  
1.98kg (4.37lb.)

**Two Pole**



Rated Current	Type/ Cat. No.	Rated Voltage
0.3A	2D03UL	480Y/277V AC
0.5A	2D05UL	480Y/277V AC
1.0A	2D1UL	480Y/277V AC
1.6A	2D1.6UL	480Y/277V AC
2.0A	2D2UL	480Y/277V AC
3.0A	2D3UL	480Y/277V AC
4.0A	2D4UL	480Y/277V AC
5.0A	2D5UL	480Y/277V AC
6.0A	2D6UL	480Y/277V AC
8.0A	2D8UL	480Y/277V AC
10A	2D10UL	480Y/277V AC
12A	2D12UL	480Y/277V AC
13A	2D13UL	480Y/277V AC
15A	2D15UL	480Y/277V AC
16A	2D16UL	480Y/277V AC
20A	2D20UL	480Y/277V AC
25A	2D25UL	480Y/277V AC
30A	2D30UL	480Y/277V AC
32A	2D32UL	480Y/277V AC
40A	2D40UL	240V AC
50A	2D50UL	240V AC
60A	2D60UL	240V AC
63A	2D63UL	240V AC

Standard Pack: 6

Weight:  
0.3-32A:  
1.74kg (3.83lb.)  
40-63A:  
1.98kg (4.37lb.)

**Add-on Neutral Pole**



Rated Current	Type/ Cat. No.	Rated Voltage
0.3-32A	N32UL	480/277V AC
40-63A	N63UL	240V AC

Standard Pack: 6

Weight:  
0.99kg (2.18 lb.)

**Standard Dual Connection Terminal**

- Box clamp terminals  
Top: 18-3 AWG;  
Bottom: 18-2 AWG  
(Line/Load reversible)
- Ring tongue terminals

*\* May differ by manufacturer. Top terminal ring tongue max. thickness 1.6mm.*

UL 489

UL 508

UL 1077

UL 1077  
Equipment Breakers

Earth Leakage  
Circuit Breakers

ANNEX

# UL - Series C-Trip (DC) Characteristic

### Application Examples:

Telecommunication equipment,  
computer equipment, uninterruptable power supplies.



E329510

### One Pole



Standard Pack: 12

Weight:  
0.3-32A:  
1.86kg (4.1lb.)  
40-63A:  
2.10kg (4.6lb.)

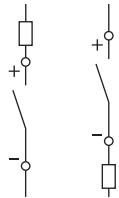

Rated Current	Type/ Cat. No.	Rated Voltage
0.3A	1C03DL	125V DC
0.5A	1C05DL	125V DC
1.0A	1C1DL	125V DC
1.6A	1C1.6DL	125V DC
2.0A	1C2DL	125V DC
3.0A	1C3DL	125V DC
4.0A	1C4DL	125V DC
5.0A	1C5DL	125V DC
6.0A	1C6DL	125V DC
8.0A	1C8DL	125V DC
10A	1C10DL	125V DC
12A	1C12DL	125V DC
13A	1C13DL	125V DC
15A	1C15DL	125V DC
16A	1C16DL	125V DC
20A	1C20DL	125V DC
25A	1C25DL	125V DC
30A	1C30DL	125V DC
32A	1C32DL	125V DC
40A	1C40DL	125V DC
50A	1C50DL	125V DC
60A	1C60DL	125V DC
63A	1C63DL	125V DC

### Two Pole



Standard Pack: 6

Weight:  
0.3-32A:  
1.86kg (4.1lb.)  
40-63A:  
2.10kg (4.6lb.)

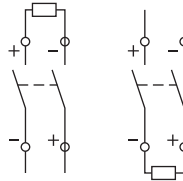

Rated Current	Type/ Cat. No.	Rated Voltage
0.3A	2C03DL	250V DC
0.5A	2C05DL	250V DC
1.0A	2C1DL	250V DC
1.6A	2C1.6DL	250V DC
2.0A	2C2DL	250V DC
3.0A	2C3DL	250V DC
4.0A	2C4DL	250V DC
5.0A	2C5DL	250V DC
6.0A	2C6DL	250V DC
8.0A	2C8DL	250V DC
10A	2C10DL	250V DC
12A	2C12DL	250V DC
13A	2C13DL	250V DC
15A	2C15DL	250V DC
16A	2C16DL	250V DC
20A	2C20DL	250V DC
25A	2C25DL	250V DC
30A	2C30DL	250V DC
32A	2C32DL	250V DC
40A	2C40DL	250V DC
50A	2C50DL	250V DC
60A	2C60DL	250V DC
63A	2C63DL	250V DC



**Warning!**  
Correct polarity must be observed  
when connecting the DC circuit breakers.



### Standard Dual Connection Terminal

- Box clamp terminals  
Top: 18-3 AWG;  
Bottom: 18-2 AWG  
(Line/Load reversible)
- Ring tongue terminals

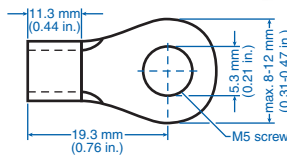
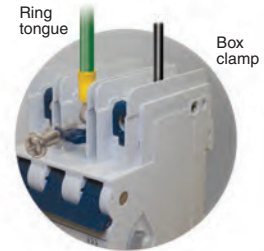

\* May differ by manufacturer. Top terminal ring tongue max. thickness 1.6mm.

# UL - Series D-Trip (DC) Characteristic

### Application Examples:

Telecommunication equipment,  
computer equipment, uninterruptable power supplies.



### One Pole



Standard Pack: 12

Weight:

0.3-32A:

1.86kg (4.1lb.)

40-63A:

2.10kg (4.6lb.)

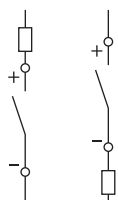

Rated Current	Type/ Cat. No.	Rated Voltage
0.3A	1D03DL	125V DC
0.5A	1D05DL	125V DC
1.0A	1D1DL	125V DC
1.6A	1D1.6DL	125V DC
2.0A	1D2DL	125V DC
3.0A	1D3DL	125V DC
4.0A	1D4DL	125V DC
5.0A	1D5DL	125V DC
6.0A	1D6DL	125V DC
8.0A	1D8DL	125V DC
10A	1D10DL	125V DC
12A	1D12DL	125V DC
13A	1D13DL	125V DC
15A	1D15DL	125V DC
16A	1D16DL	125V DC
20A	1D20DL	125V DC
25A	1D25DL	125V DC
30A	1D30DL	125V DC
32A	1D32DL	125V DC
40A	1D40DL	125V DC
50A	1D50DL	125V DC
60A	1D60DL	125V DC
63A	1D63DL	125V DC

### Two Pole



Standard Pack: 6

Weight:

0.3-32A:  
1.86kg (4.1lb.)

40-63A:  
2.10kg (4.6lb.)

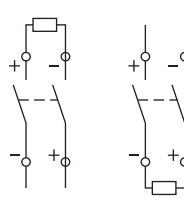

Rated Current	Type/ Cat. No.	Rated Voltage
0.3A	2D03DL	250V DC
0.5A	2D05DL	250V DC
1.0A	2D1DL	250V DC
1.6A	2D1.6DL	250V DC
2.0A	2D2DL	250V DC
3.0A	2D3DL	250V DC
4.0A	2D4DL	250V DC
5.0A	2D5DL	250V DC
6.0A	2D6DL	250V DC
8.0A	2D8DL	250V DC
10A	2D10DL	250V DC
12A	2D12DL	250V DC
13A	2D13DL	250V DC
15A	2D15DL	250V DC
16A	2D16DL	250V DC
20A	2D20DL	250V DC
25A	2D25DL	250V DC
30A	2D30DL	250V DC
32A	2D32DL	250V DC
40A	2D40DL	250V DC
50A	2D50DL	250V DC
60A	2D60DL	250V DC
63A	2D63DL	250V DC



### Warning!

Correct polarity must be observed  
when connecting the DC circuit breakers.



### Standard Dual Connection Terminal

- Box clamp terminals  
Top: 18-3 AWG;  
Bottom: 18-2 AWG  
(Line/Load reversible)
- Ring tongue terminals

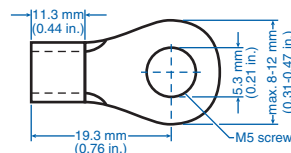
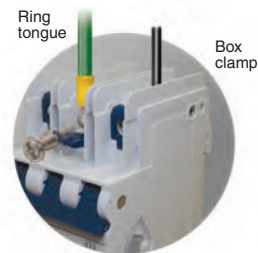

\* May differ by manufacturer. Top terminal ring tongue max. thickness 1.6mm.

UL 489

UL 508

UL 1077

UL 1077  
Equipment Breakers

Earth Leakage  
Circuit Breakers

ANNEX

# UL/DL Series Accessories

For mounting instructions please refer to page 43.



## Auxiliary Contact, Alarm Switch

Type/ Cat No.	Description	Contacts Type	Std Pk
H10UL	1 Auxiliary Contact	1NO	6
H11UL	2 Auxiliary Contacts	1NO + 1NC	6
H12UL	3 Auxiliary Contacts	1NO + 2NC	6
H21UL	3 Auxiliary Contacts	2NO + 1NC	6
HLS11L*	1 Auxiliary/1 Signal Contact	1CO + 1CO (Signal)	6

<b>Rated Operating Currents</b>	10A@240V AC 3A@110V DC 1A@220V DC
---------------------------------	---

<b>Minimum Contact Load</b>	1mA @ 24V DC
<b>Torque</b>	max. 0.8Nm (7 lb.in)

<b>Wire Range:</b>	
<b>Single Wire</b>	1.0mm <sup>2</sup> - 2.5mm <sup>2</sup> (18-14 AWG)
<b>Stranded Wire</b>	1.0mm <sup>2</sup> - 1.5mm <sup>2</sup> (18-16 AWG)
<b>Stranded Wire with Ferrule</b>	1.0mm <sup>2</sup> - 1.5mm <sup>2</sup> (18-16 AWG)

## Shunt Trip

Type/ Cat No.	Rated Voltage U <sub>N</sub>	Max. Operating Current @ U <sub>N</sub>	Std Pk
FA12UL	12V AC/DC	1.3A	5
FA24UL	24V AC/DC	0.6A	5
FA48UL	48 - 72V AC/DC	0.2A	5
FA110UL	110 - 240V AC/DC, 277V AC	0.25A @ 110V 0.5A @ 240V 0.58A @ 277V	5

## Undervoltage Trip\*

Type/ Cat No.	Line Voltage V <sub>E</sub>	Std Pk
UA120UL	120V AC, 60Hz	5

Reset-Hold Voltage = 0.85 x V<sub>E</sub>  
Drop-Out Voltage = 0.35 ~ 0.7 x V<sub>E</sub>

V<sub>E</sub> = Rated Voltage

## Neutral Pole

Type/ Cat No.	Rated Current I <sub>N</sub>	Rated Voltage U <sub>N</sub>	Std Pk
N32UL	0.3 - 32A	480Y/277V AC	6
N63UL	40 - 63A	240V AC	6

## Touch Protection Caps

to cover the terminal screw holes on the switching devices, neutral Poles and shunt trips for increased touch protection.

Type/ Cat No.	Std Pk
BS.UL	100

## Cooling Spacer



Type/ Cat No.	Std Pk
15.960	1



## Lock-out Adapter\*\*

Type/ Cat No.	Std Pk
E983419	10

Type/ Cat No.	Std Pk
EASS	10

\* UL not approved.

\*\* UL and DL series can also be locked in the on and off position by simply using a common lead or meter seal, which gets fed through the hole in the handle and a corresponding hole in the housing.

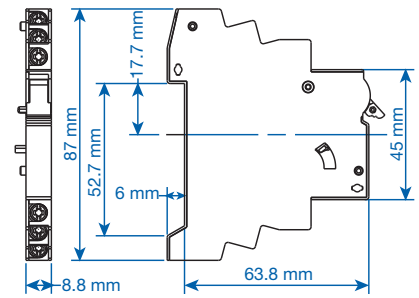

Dimensions HxxUL.

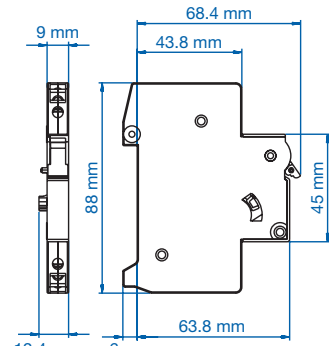

Dimensions HLS11L.

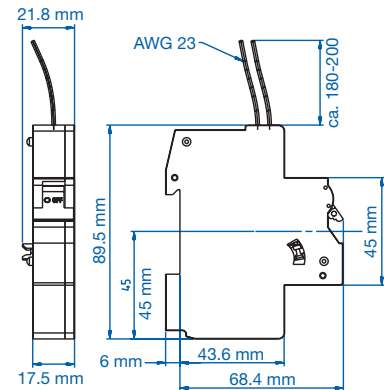

Dimensions UA120UL

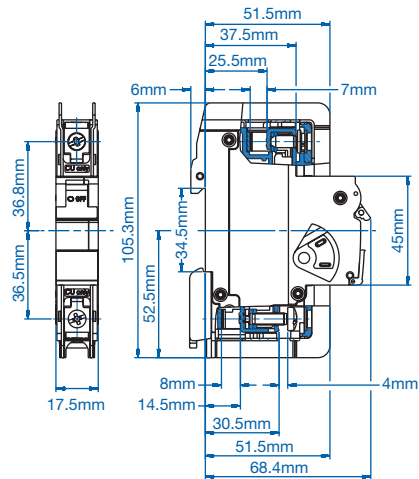

Dimensions NxxUL, FxxUL

# UL Series (AC) Trip Curves

UL 489

UL 508

UL 1077

UL 1077  
Equipment Breakers

Earth Leakage  
Circuit Breakers

ANNEX

## C (AC) Trip Curve

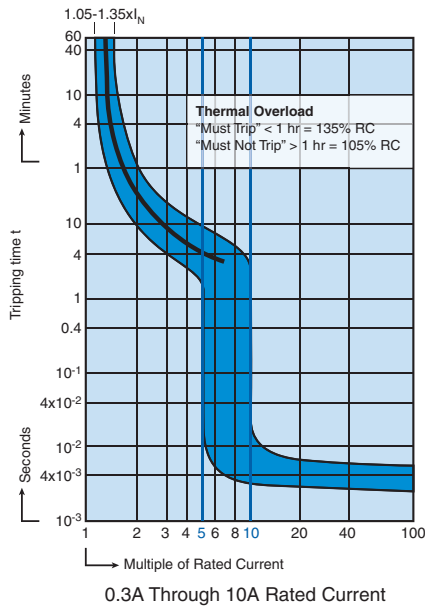

## D (AC) Trip Curve

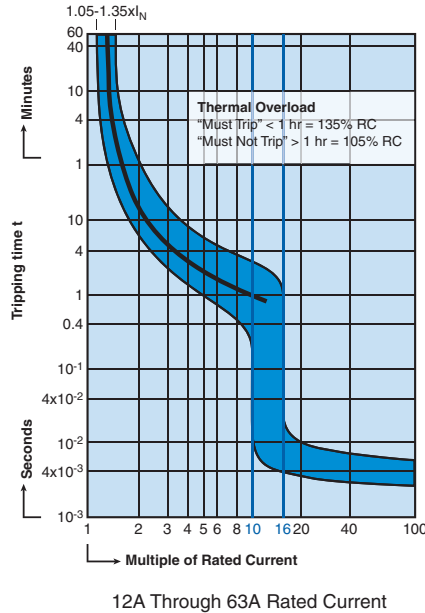
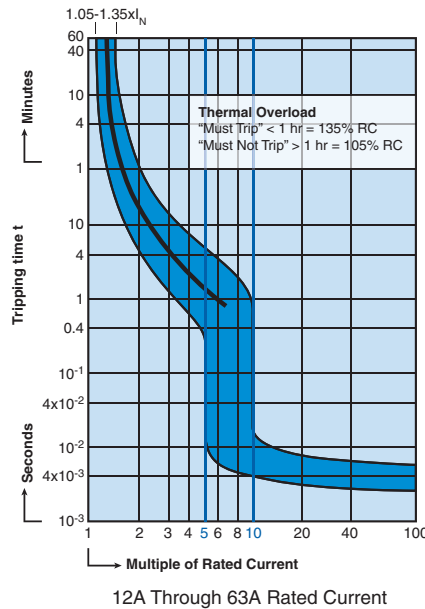
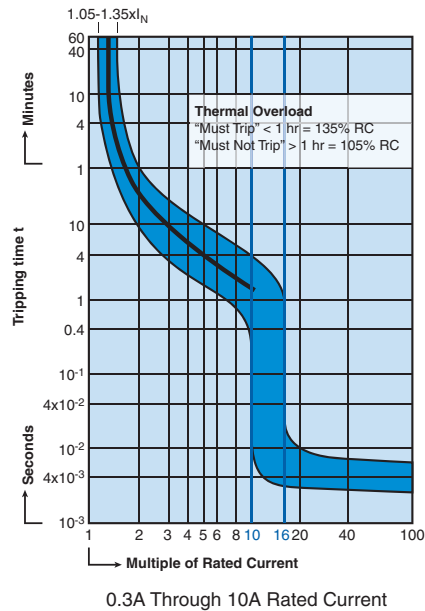

### “C” Magnetic Trip Parameters Rated current 0.3A to 63A.

1. Hold for a minimum of 100ms at surge of 5 times rated current.
2. Trip in under 100ms at 10 times rated current.

### “D” Magnetic Trip Parameters Rated current 0.3A to 63A.

1. Hold for a minimum of 100ms at surge of 10 times rated current.
2. Trip in under 100ms at 16 times rated current.



# UL Series (DC) Trip Curves

## C (DC) Trip Curve

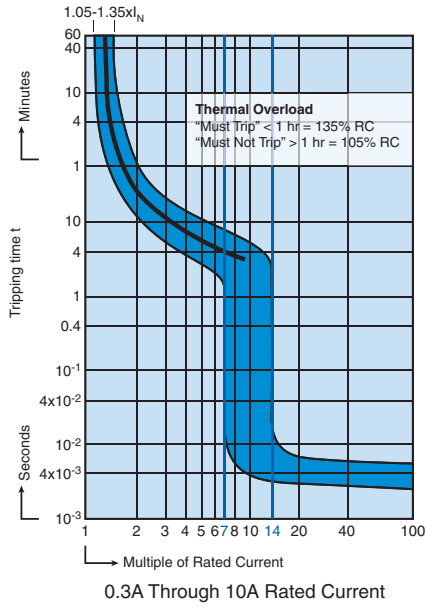

## D (DC) Trip Curve

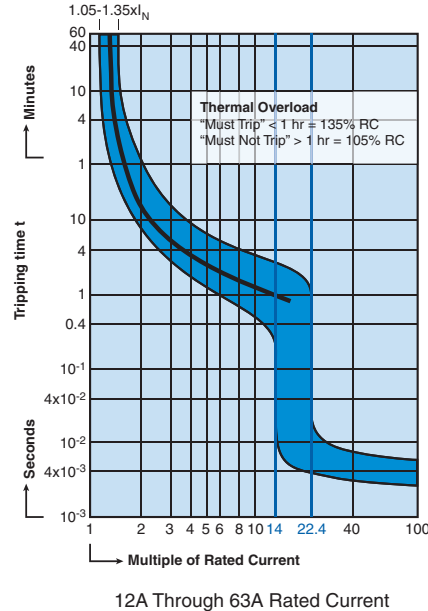
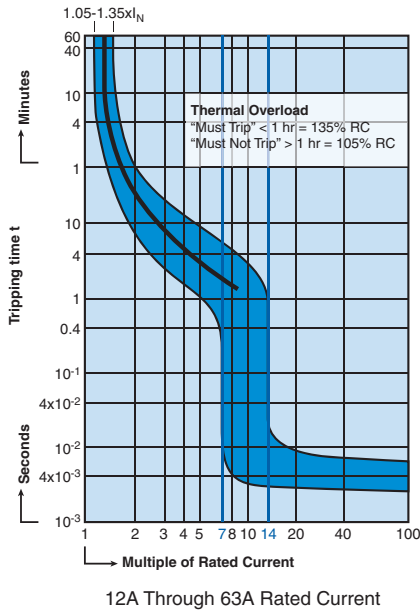
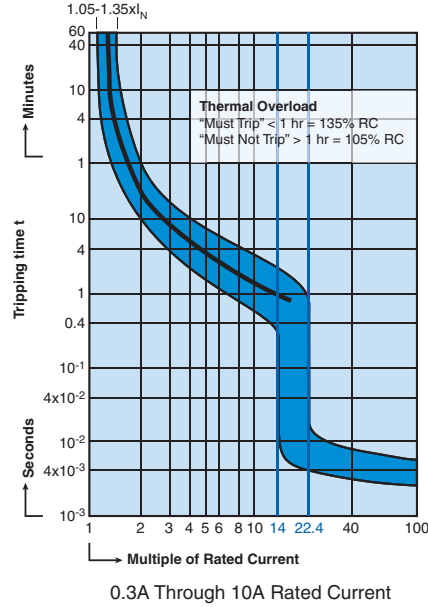

### “C” Magnetic Trip Parameters Rated current 0.3A to 63A.

1. Hold for a minimum of 100ms at surge of 7 times rated current.
2. Trip in under 100ms at 14 times rated current.

### “D” Magnetic Trip Parameters Rated current 0.3A to 63A.

1. Hold for a minimum of 100ms at surge of 14 times rated current.
2. Trip in under 100ms at 22.4 times rated current.

**UL/ DL Series Internal Resistance**

Rated Current (A)	Trip Characteristic	
	C (Ohm)	D (Ohm)
0.3	16.8620	16.8620
0.5	6.8540	6.0009
1.0	1.7000	1.7560
1.6	0.5870	0.5870
2.0	0.4190	0.4190
3.0	0.2020	0.2020
4.0	0.1090	0.1090
5.0	0.0654	0.0654
6.0	0.0528	0.0491
8.0	0.0278	0.0240
10	0.0216	0.0187
12	0.0084	0.0085
13	0.0084	0.0085
15/ 16	0.0085	0.0076
20	0.0067	0.0064
25	0.0050	0.0041
30/ 32	0.0032	0.0027
40	0.0025	0.0022
50	0.0019	0.0018
60/ 63	0.0018	0.0017

**UL Series Let-through Energy I<sup>2</sup>t Diagram, D Trip 1 pole**

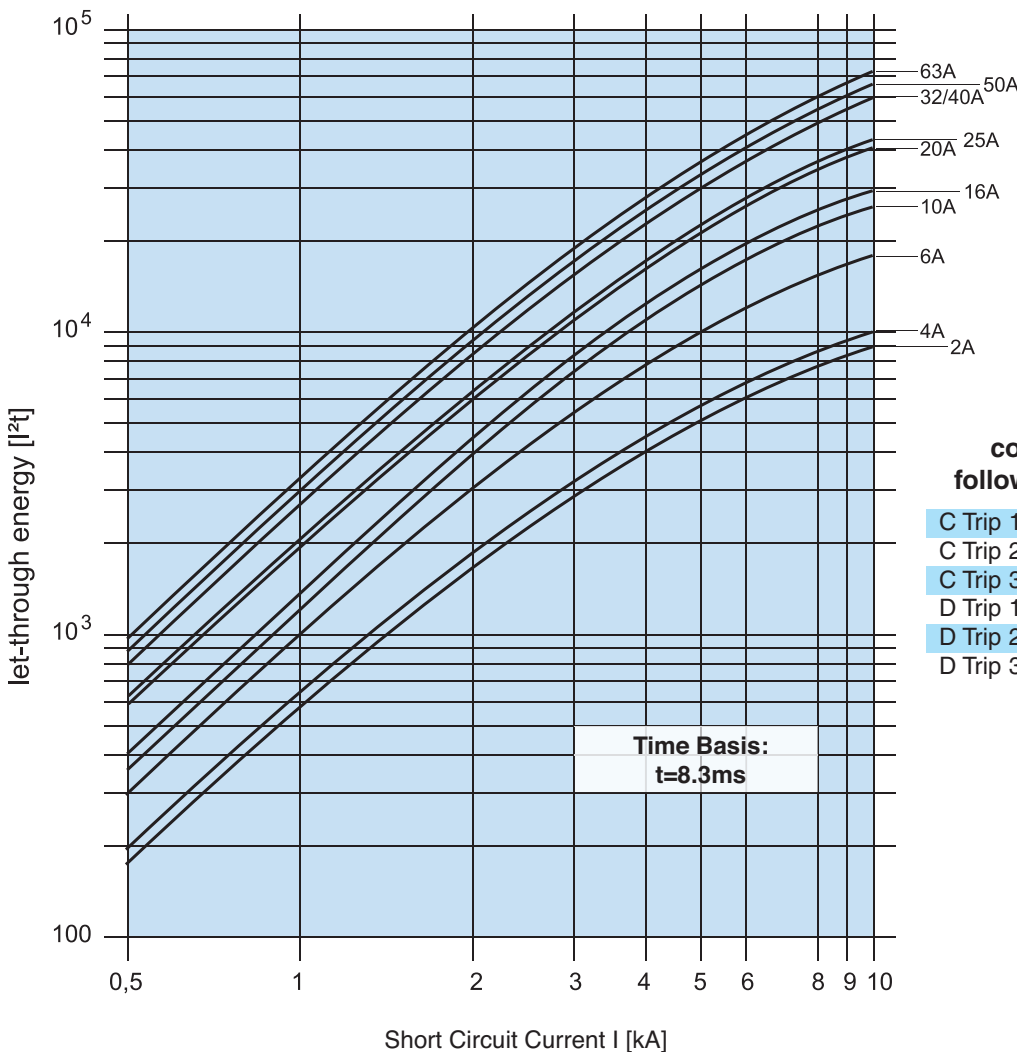

UL 489

UL 508

UL 1077

UL 1077  
Equipment Breakers

Earth Leakage  
Circuit Breakers

ANNEX

# Mouser Electronics

Authorized Distributor

Click to View Pricing, Inventory, Delivery & Lifecycle Information:

[Altech:](#)

[BS.UL](#)