

Data sheet | Item number: 2086-1222/300-000

THR PCB terminal block; push-button; 1.5 mm²; Pin spacing 3.5 mm; 2-pole;
Push-in CAGE CLAMP®; Solder pin length 1.5 mm; 1,50 mm²; black

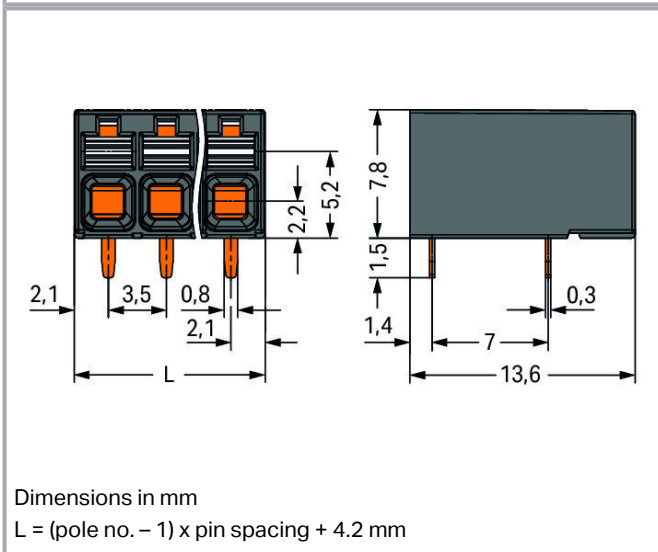

www.wago.com/2086-1222/300-000

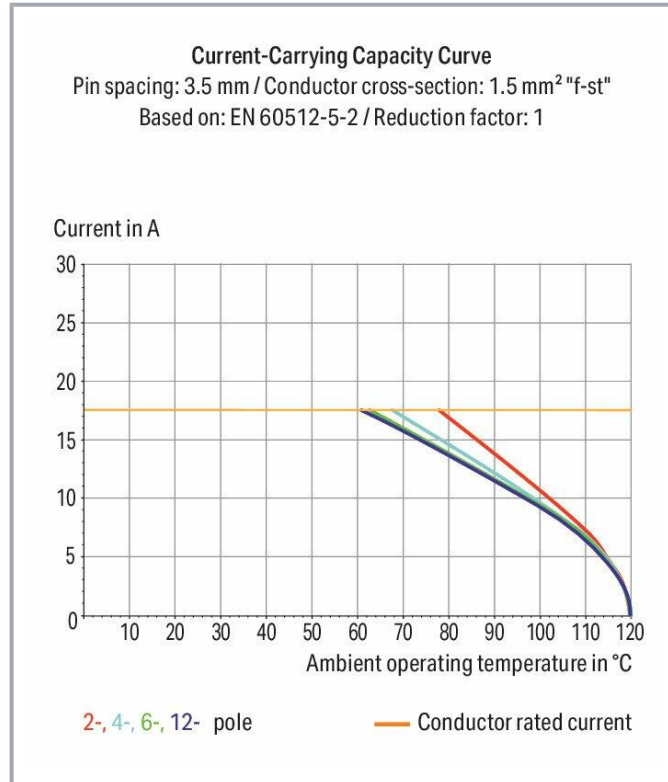
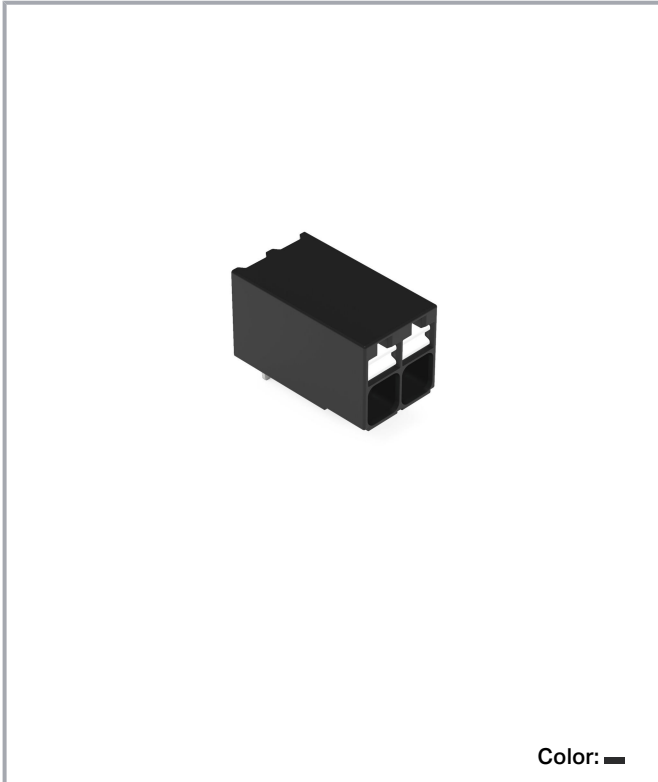

Subject to changes. Please also observe the further product documentation!

WAGO Kontakttechnik GmbH & Co. KG
Hansastr. 27
32423 Minden
Phone: +49571 887-0 | Fax: +49571 887-169
Email: info.de@wago.com | Web: www.wago.com

Do you have any questions about our products?
We are always happy to take your call at 01788 568 008.

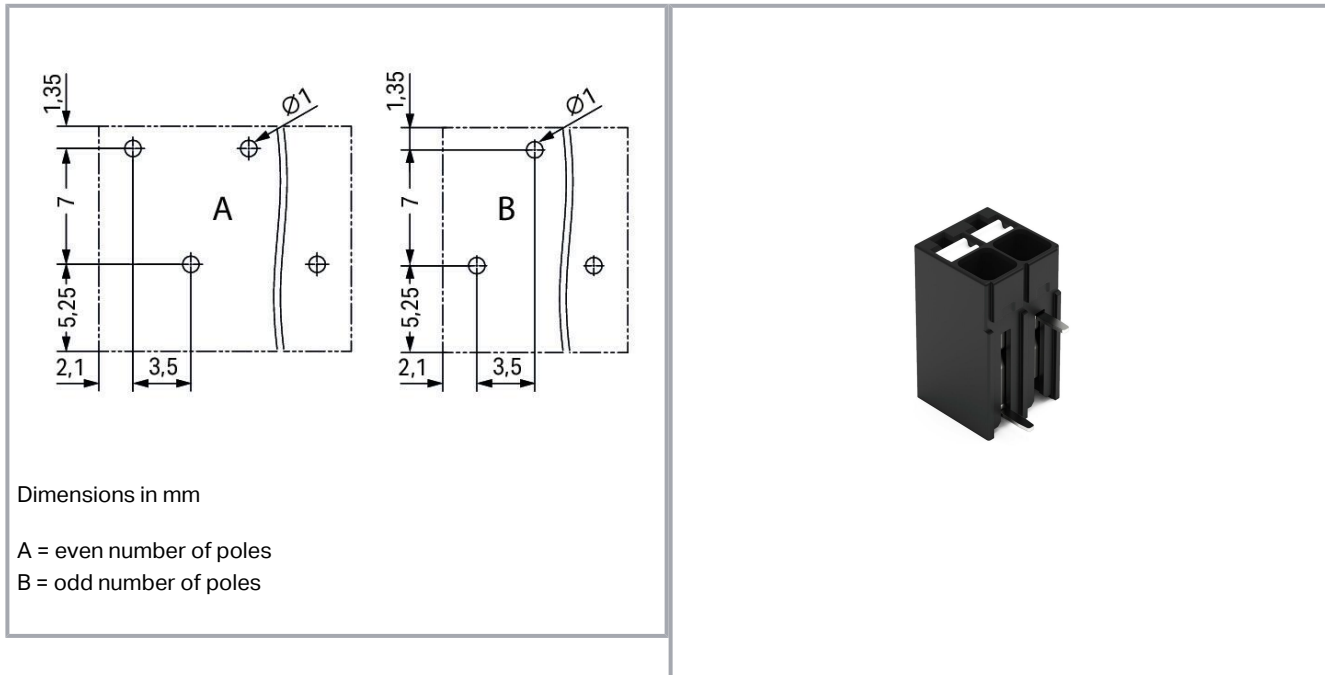

Item description

- Ideal for compact device connection, panel feedthrough and tight spaces
- Push-in CAGE CLAMP® allows push-in termination of solid and fine-stranded conductors with ferrules
- SMD and THR variants available
- Delivery in tape-and-reel packaging for full integration into SMT soldering process
- Push-button moves in direction of conductor connection
- Conductor connection and mating direction both parallel and perpendicular to the PCB
- Choice of double pin spacing or alternating pin spacing, 3.5 and 5 mm pin spacing

Data

Electrical data

Ratings per IEC/EN

Ratings per	IEC/EN 60664-1
Nominal voltage (III/3)	250 V
Rated surge voltage (III/3)	4 kV
Rated voltage (III/2)	320 V
Rated surge voltage (III/2)	4 kV
Nominal voltage (II/2)	630 V

Subject to changes. Please also observe the further product documentation!

WAGO Kontakttechnik GmbH & Co. KG
Hansastr. 27
32423 Minden
Phone: +49571 887-0 | Fax: +49571 887-169
Email: info.de@wago.com | Web: www.wago.com

Do you have any questions about our products?
We are always happy to take your call at 01788 568 008.



Rated surge voltage (II/2)	4 kV
Rated current	17.5 A
Legend (ratings)	(III / 2) $\hat{=}$ Overvoltage category III / Pollution degree 2

Ratings per UL

Approvals per	UL 1059
Rated voltage UL (Use Group B)	300 V
Rated current UL (Use Group B)	10 A
Rated voltage UL (Use Group C)	300 V
Rated current UL (Use Group C)	10 A
Rated voltage UL (Use Group D)	300 V
Rated current UL (Use Group D)	10 A

Ratings per CSA

Approvals per	CSA
Rated voltage CSA (Use Group B)	300 V
Rated current CSA (Use Group B)	10 A
Rated voltage CSA (Use Group D)	300 V
Rated current CSA (Use Group D)	10 A

Connection data

Total number of potentials	2
Number of connection types	1
Number of levels	1

Connection 1

Connection technology	Push-in CAGE CLAMP [®]
Actuation type	Push-button
Solid conductor	0.14 ... 1.5 mm ² / 24 ... 16 AWG
Fine-stranded conductor	0.14 ... 1.5 mm ² / 24 ... 16 AWG
Fine-stranded conductor; with insulated ferrule	0.25 ... 0.75 mm ²
Fine-stranded conductor; with uninsulated ferrule	0.25 ... 1.5 mm ²
Conductor diameter	24 ... 16 AWG
Strip length	8 ... 9 mm / 0.31 ... 0.35 inch
Conductor connection direction to PCB	0°
Pole No.	2

Subject to changes. Please also observe the further product documentation!



Physical data

Pin spacing	3.5 mm / 0.138 inch
Width	7.7 mm / 0.303 inch
Height	9.3 mm / 0.366 inch
Height from the surface	7.8 mm / 0.307 inch
Depth	13.6 mm / 0.535 inch
Solder pin length	1.5 mm
Solder pin dimensions	0.3 x 0.8 mm
Plated through-hole diameter (THR)	1 ^(+0.1) mm

PCB contact

PCB Contact	THR
Solder pin arrangement	over the entire terminal strip (staggered)
Number of solder pins per potential	1

Material data

Color	black
Insulation material	Polyphthalamide (PPA GF)
Flammability class per UL94	V0
Clamping spring material	Chrome nickel spring steel (CrNi)
Contact material	Electrolytic copper (E _{Cu})
Contact plating	tin-plated
Weight	1 g

Environmental requirements

Limit temperature range	-60 ... +105 °C
-------------------------	-----------------

Commercial data

PU (SPU)	432 Stück
Packaging type	BOX
Country of origin	CH
GTIN	4055144088892
Customs tariff number	85369010000



Approvals / Certificates

Subject to changes. Please also observe the further product documentation!

WAGO Kontakttechnik GmbH & Co. KG
 Hansastr. 27
 32423 Minden
 Phone: +49571 887-0 | Fax: +49571 887-169
 Email: info.de@wago.com | Web: www.wago.com

Do you have any questions about our products?
 We are always happy to take your call at 01788 568 008.









Country specific Approvals

Logo	Approval	Additional Approval Text	Certificate name
	CB DEKRA Certification B.V.	IEC 60947-7-4	NL-74022
	CSA DEKRA Certification B.V.	C22.2	80060692
	KEMA/KEUR DEKRA Certification B.V.	EN 60947-7-4	71- 119449

Optional accessories

Ferrule		
Ferrule		
	Item no.: 216-101 Ferrule; Sleeve for 0.5 mm ² / AWG 22; uninsulated; electro-tin plated; silver-colored	www.wago.com/216-101
	Item no.: 216-104 Ferrule; Sleeve for 1.5 mm ² / AWG 16; uninsulated; electro-tin plated; silver-colored	www.wago.com/216-104
	Item no.: 216-102 Ferrule; Sleeve for 0.75 mm ² / AWG 20; uninsulated; electro-tin plated; silver-colored	www.wago.com/216-102
	Item no.: 216-103 Ferrule; Sleeve for 1 mm ² / AWG 18; uninsulated; electro-tin plated	www.wago.com/216-103
	Item no.: 216-142 Ferrule; Sleeve for 0.75 mm ² / 18 AWG; uninsulated; electro-tin plated; electrolytic copper; gastight crimped; acc. to DIN 46228, Part 1/08.92	www.wago.com/216-142
	Item no.: 216-132 Ferrule; Sleeve for 0.34 mm ² / AWG 24; uninsulated; electro-tin plated	www.wago.com/216-132
	Item no.: 216-121 Ferrule; Sleeve for 0.5 mm ² / AWG 22; uninsulated; electro-tin plated; silver-colored	www.wago.com/216-121
	Item no.: 216-143 Ferrule; Sleeve for 1 mm ² / AWG 18; uninsulated; electro-tin plated; electrolytic copper; gastight crimped; acc. to DIN 46228, Part 1/08.92	www.wago.com/216-143
	Item no.: 216-131 Ferrule; Sleeve for 0.25 mm ² / AWG 24; uninsulated; electro-tin plated; silver-colored	www.wago.com/216-131
	Item no.: 216-141 Ferrule; Sleeve for 0.5 mm ² / 20 AWG; uninsulated; electro-tin plated; electrolytic copper; gastight crimped; acc. to DIN 46228, Part 1/08.92	www.wago.com/216-141



Subject to changes. Please also observe the further product documentation!

	Item no.: 216-152 Ferrule; Sleeve for 0.34 mm ² / AWG 24; uninsulated; electro-tin plated	www.wago.com/216-152
	Item no.: 216-202 Ferrule; Sleeve for 0.75 mm ² / 18 AWG; insulated; electro-tin plated; gray	www.wago.com/216-202
	Item no.: 216-151 Ferrule; Sleeve for 0.25 mm ² / AWG 24; uninsulated; electro-tin plated	www.wago.com/216-151
	Item no.: 216-144 Ferrule; Sleeve for 1.5 mm ² / AWG 16; uninsulated; electro-tin plated; electrolytic copper; gastight crimped; acc. to DIN 46228, Part 1/08.92; silver-colored	www.wago.com/216-144
	Item no.: 216-201 Ferrule; Sleeve for 0.5 mm ² / 20 AWG; insulated; electro-tin plated; white	www.wago.com/216-201
	Item no.: 216-241 Ferrule; Sleeve for 0.5 mm ² / 20 AWG; insulated; electro-tin plated; electrolytic copper; gastight crimped; acc. to DIN 46228, Part 4/09.90; white	www.wago.com/216-241
	Item no.: 216-242 Ferrule; Sleeve for 0.75 mm ² / 18 AWG; insulated; electro-tin plated; electrolytic copper; gastight crimped; acc. to DIN 46228, Part 4/09.90; gray	www.wago.com/216-242
	Item no.: 216-301 Ferrule; Sleeve for 0.25 mm ² / AWG 24; insulated; electro-tin plated; yellow	www.wago.com/216-301
	Item no.: 216-302 Ferrule; Sleeve for 0.34 mm ² / 22 AWG; insulated; electro-tin plated; green	www.wago.com/216-302

Tool

Operating tool		
	Item no.: 210-719 Operating tool; Blade: 2.5 x 0.4 mm; with a partially insulated shaft	www.wago.com/210-719

Testing and measuring

Testing accessories		
	Item no.: 735-500 Test pin; 1 mm Ø; with solder connection for test wire	www.wago.com/735-500
	Item no.: 859-500 Test pin; 1 mm Ø; with solder connection for test wire	www.wago.com/859-500

Downloads

Documentation

Additional Information

Technical explanations	Apr 3, 2019	pdf 2.0 MB	Download
THR Soldering Process		pdf 548.2 kB	Download

Subject to changes. Please also observe the further product documentation!

CAD/CAE-Data

CAD data

2D/3D Models 2086-1222/300-000	URL	Download
--------------------------------	---------------------	--------------------------

CAE data

ZUKEN Portal 2086-1222/300-000	URL	Download
--------------------------------	---------------------	--------------------------

Environmental Product Compliance

Compliance Search

Environmental Product Compliance 2086-1222/300-000	URL	Download
--	---------------------	--------------------------

THR PCB terminal block; push-button; 1.5 mm²; Pin spacing 3.5 mm; 2-pole; Push-in CAGE CLAMP®; Solder pin length 1.5 mm; 1,50 mm²; black

Installation Notes

Conductor termination



Inserting solid conductor via push-in termination.

Conductor removal

Subject to changes. Please also observe the further product documentation!



Removing fine-stranded conductors via push-buttons.

Conductor termination



Inserting and removing fine-stranded conductors via push-buttons.

Testing



Testing via 1 mm Ø test pin.

Touch contact with current bar.

Marking

Subject to changes. Please also observe the further product documentation!



Pole marking via direct marking
perpendicular to conductor entry.

Subject to changes. Please also observe the further product documentation!