

**POSITIVE VOLTAGE REGULATORS**

- OUTPUT CURRENT UP TO 100 mA
- OUTPUT VOLTAGES OF 5; 6; 8; 9; 12; 15; 18; 24V
- THERMAL OVERLOAD PROTECTION
- SHORT CIRCUIT PROTECTION
- NO EXTERNAL COMPONENTS ARE REQUIRED
- AVAILABLE IN EITHER  $\pm 5\%$  (AC) OR  $\pm 10\%$  (C) SELECTION

**DESCRIPTION**

The L78L00 series of three-terminal positive regulators employ internal current limiting and thermal shutdown, making them essentially indestructible. If adequate heatsink is provided, they can deliver up to 100 mA output current. They are intended as fixed voltage regulators in a wide range of applications including local or on-card regulation for elimination of noise and distribution problems associated with single-point regulation. In addition, they can be used with power pass elements to make high-current voltage regulators.

The L78L00 series used as Zener diode/resistor combination replacement, offers an effective output impedance improvement of typically two orders of magnitude, along with lower quiescent current and lower noise.

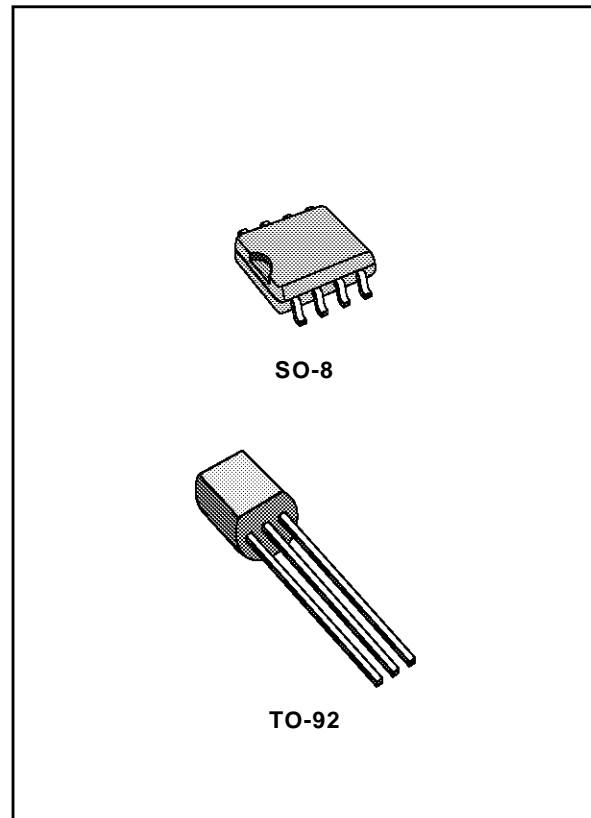

**SCHEMATIC DIAGRAM**

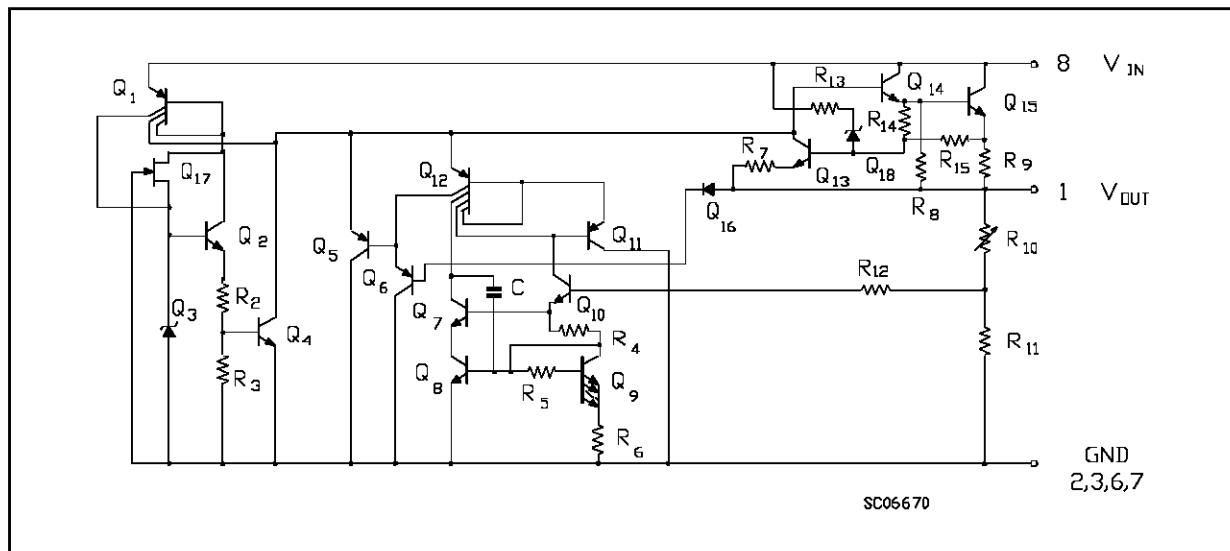

## L78L00 SERIES

### ABSOLUTE MAXIMUM RATING

Symbol	Parameter	Value	Unit	
$V_i$	DC Input Voltage	$V_o = 5 \text{ V to } 9 \text{ V}$	30	V
		$V_o = 12 \text{ V to } 15 \text{ V}$	35	V
		$V_o = 18 \text{ V to } 24 \text{ V}$	40	V
$I_o$	Output Current	100	mA	
$P_{tot}$	Power Dissipation	Internally limited (*)		
$T_{stg}$	Storage Temperature Range	- 40 to 150	°C	
$T_{op}$	Operating Junction Temperature Range	For L78L00C, L78L00AC	0 to 125	°C
		For L78L00AB	- 40 to 125	°C

(\*) Our SO-8 package used for Voltage Regulators is modified internally to have pins 2, 3, 6 and 7 electrically commoned to the die attach flag. This particular frame decreases the total thermal resistance of the package and increases its ability to dissipate power when an appropriate area of copper on the printed circuit board is available for heatsinking. The external dimensions are the same as for the standard SO-8

### TEST CIRCUITS

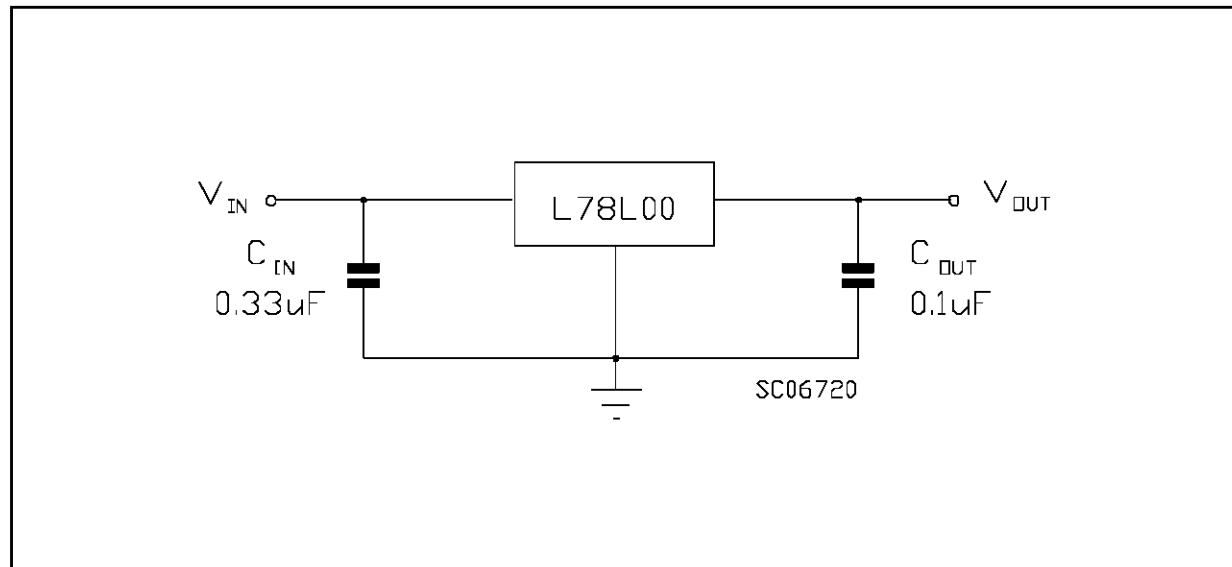

CONNECTION DIAGRAM AND ORDERING NUMBERS (top view)

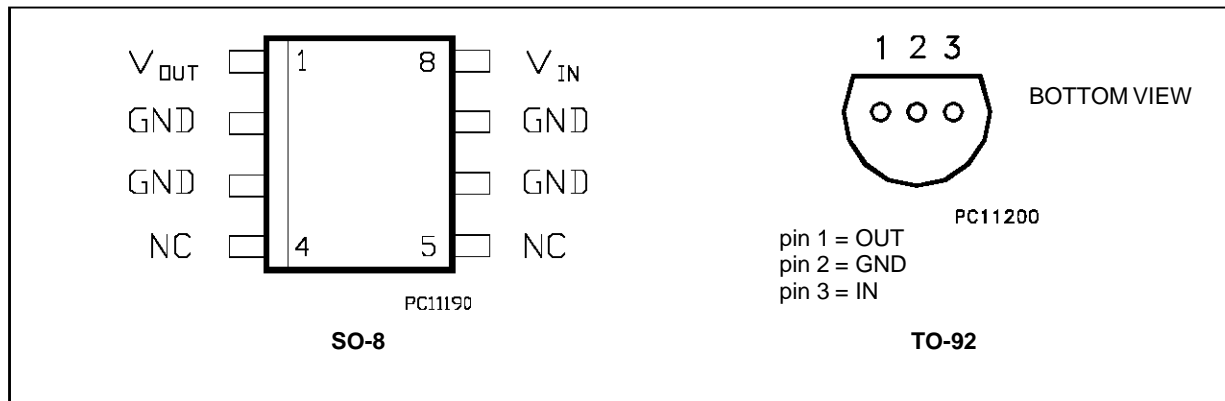

ORDERING NUMBERS

Type	SO-8	TO-92	Output Voltage
L78L05C	L78L05CD	L78L05CZ	5 V
L78L05AC	L78L05ACD	L78L05ACZ	5 V
L78L05AB	L78L05ABD	L78L05ABZ	5 V
L78L06C	L78L06CD	L78L06CZ	6 V
L78L06AC	L78L06ACD	L78L06ACZ	6 V
L78L06AB	L78L06ABD	L78L06ABZ	6 V
L78L08C	L78L08CD	L78L08CZ	8 V
L78L08AC	L78L08ACD	L78L08ACZ	8 V
L78L08AB	L78L08ABD	L78L08ABZ	8 V
L78L09C	L78L09CD	L78L09CZ	9 V
L78L09AC	L78L09ACD	L78L09ACZ	9 V
L78L09AB	L78L09ABD	L78L09ABZ	9 V
L78L12C	L78L12CD	L78L12CZ	12 V
L78L12AC	L78L12ACD	L78L12ACZ	12 V
L78L12AB	L78L12ABD	L78L12ABZ	12 V
L78L15C	L78L15CD	L78L15CZ	15 V
L78L15AC	L78L15ACD	L78L15ACZ	15 V
L78L15AB	L78L15ABD	L78L15ABZ	15 V
L78L18C	L78L18CD	L78L18CZ	18 V
L78L18AC	L78L18ACD	L78L18ACZ	18 V
L78L18AB	L78L18ABD	L78L18ABZ	18 V
L78L24C	L78L24CD	L78L24CZ	24 V
L78L24AC	L78L24ACD	L78L24ACZ	24 V
L78L24AB	L78L24ABD	L78L24ABZ	24 V

## L78L00 SERIES

**ELECTRICAL CHARACTERISTICS FOR L78L05** (refer to the test circuits,  $T_j = 0$  to  $125$  °C,  $V_i = 10V$ ,  $I_o = 40$  mA,  $C_i = 0.33$   $\mu$ F,  $C_o = 0.1$   $\mu$ F unless otherwise specified)

Symbol	Parameter	Test Conditions	Min.	Typ.	Max.	Unit
$V_o$	Output Voltage	$T_j = 25$ °C	4.6	5	5.4	V
$V_o$	Output Voltage	$I_o = 1$ to $40$ mA $V_i = 7$ to $20$ V $I_o = 1$ to $70$ mA $V_i = 10$ V	4.5 4.5		5.5 5.5	V V
$\Delta V_o$	Line Regulation	$V_i = 7$ to $20$ V $T_j = 25$ °C $V_i = 8$ to $20$ V $T_j = 25$ °C			200 150	mV mV
$\Delta V_o$	Load Regulation	$I_o = 1$ to $100$ mA $T_j = 25$ °C $I_o = 1$ to $40$ mA $T_j = 25$ °C			60 30	mV mV
$I_d$	Quiescent Current	$T_j = 25$ °C $T_j = 125$ °C			6 5.5	mA mA
$\Delta I_d$	Quiescent Current Change	$I_o = 1$ to $40$ mA			0.2	mA
$\Delta I_d$	Quiescent Current Change	$V_i = 8$ to $20$ V			1.5	mA
eN	Output Noise Voltage	$B = 10$ Hz to $100$ KHz $T_j = 25$ °C		40		$\mu$ V
SVR	Supply Voltage Rejection	$I_o = 40$ mA $f = 120$ Hz $T_j = 25$ °C $V_i = 8$ to $18$ V	40	49		dB
$V_d$	Dropout Voltage			1.7		V

**ELECTRICAL CHARACTERISTICS FOR L78L06** (refer to the test circuits,  $T_j = 0$  to  $125$  °C,  $V_i = 12V$ ,  $I_o = 40$  mA,  $C_i = 0.33$   $\mu$ F,  $C_o = 0.1$   $\mu$ F unless otherwise specified)

Symbol	Parameter	Test Conditions	Min.	Typ.	Max.	Unit
$V_o$	Output Voltage	$T_j = 25$ °C	5.52	6	6.48	V
$V_o$	Output Voltage	$I_o = 1$ to $40$ mA $V_i = 8.5$ to $20$ V $I_o = 1$ to $70$ mA $V_i = 12$ V	5.4 5.4		6.6 6.6	V V
$\Delta V_o$	Line Regulation	$V_i = 8.5$ to $20$ V $T_j = 25$ °C $V_i = 9$ to $20$ V $T_j = 25$ °C			200 150	mV mV
$\Delta V_o$	Load Regulation	$I_o = 1$ to $100$ mA $T_j = 25$ °C $I_o = 1$ to $40$ mA $T_j = 25$ °C			60 30	mV mV
$I_d$	Quiescent Current	$T_j = 25$ °C $T_j = 125$ °C			6 5.5	mA mA
$\Delta I_d$	Quiescent Current Change	$I_o = 1$ to $40$ mA			0.2	mA
$\Delta I_d$	Quiescent Current Change	$V_i = 8$ to $20$ V			1.5	mA
eN	Output Noise Voltage	$B = 10$ Hz to $100$ KHz $T_j = 25$ °C		50		$\mu$ V
SVR	Supply Voltage Rejection	$I_o = 40$ mA $f = 120$ Hz $T_j = 25$ °C $V_i = 9$ to $20$ V	38	46		dB
$V_d$	Dropout Voltage			1.7		V

**ELECTRICAL CHARACTERISTICS FOR L78L08** (refer to the test circuits,  $T_j = 0$  to  $125\text{ }^\circ\text{C}$ ,  $V_i = 14\text{V}$ ,  $I_o = 40\text{ mA}$ ,  $C_i = 0.33\text{ }\mu\text{F}$ ,  $C_o = 0.1\text{ }\mu\text{F}$  unless otherwise specified)

Symbol	Parameter	Test Conditions	Min.	Typ.	Max.	Unit
$V_o$	Output Voltage	$T_j = 25\text{ }^\circ\text{C}$	7.36	8	8.64	V
$V_o$	Output Voltage	$I_o = 1$ to $40\text{ mA}$ $V_i = 10.5$ to $23\text{ V}$ $I_o = 1$ to $70\text{ mA}$ $V_i = 14\text{ V}$	7.2 7.2		8.8 8.8	V V
$\Delta V_o$	Line Regulation	$V_i = 10.5$ to $23\text{ V}$ $T_j = 25\text{ }^\circ\text{C}$ $V_i = 11$ to $23\text{ V}$ $T_j = 25\text{ }^\circ\text{C}$			200 150	mV mV
$\Delta V_o$	Load Regulation	$I_o = 1$ to $100\text{ mA}$ $T_j = 25\text{ }^\circ\text{C}$ $I_o = 1$ to $40\text{ mA}$ $T_j = 25\text{ }^\circ\text{C}$			80 40	mV mV
$I_d$	Quiescent Current	$T_j = 25\text{ }^\circ\text{C}$ $T_j = 125\text{ }^\circ\text{C}$			6 5.5	mA mA
$\Delta I_d$	Quiescent Current Change	$I_o = 1$ to $40\text{ mA}$			0.2	mA
$\Delta I_d$	Quiescent Current Change	$V_i = 11$ to $23\text{ V}$			1.5	mA
eN	Output Noise Voltage	$B = 10\text{Hz}$ to $100\text{KHz}$ $T_j = 25\text{ }^\circ\text{C}$		60		$\mu\text{V}$
SVR	Supply Voltage Rejection	$I_o = 40\text{ mA}$ $f = 120\text{ Hz}$ $T_j = 25\text{ }^\circ\text{C}$ $V_i = 12$ to $23\text{ V}$	36	45		dB
$V_d$	Dropout Voltage			1.7		V

**ELECTRICAL CHARACTERISTICS FOR L78L09** (refer to the test circuits,  $T_j = 0$  to  $125\text{ }^\circ\text{C}$ ,  $V_i = 15\text{V}$ ,  $I_o = 40\text{ mA}$ ,  $C_i = 0.33\text{ }\mu\text{F}$ ,  $C_o = 0.1\text{ }\mu\text{F}$  unless otherwise specified)

Symbol	Parameter	Test Conditions	Min.	Typ.	Max.	Unit
$V_o$	Output Voltage	$T_j = 25\text{ }^\circ\text{C}$	8.28	9	9.72	V
$V_o$	Output Voltage	$I_o = 1$ to $40\text{ mA}$ $V_i = 11.5$ to $23\text{ V}$ $I_o = 1$ to $70\text{ mA}$ $V_i = 15\text{ V}$	8.1 8.1		9.9 9.9	V V
$\Delta V_o$	Line Regulation	$V_i = 11.5$ to $23\text{ V}$ $T_j = 25\text{ }^\circ\text{C}$ $V_i = 12$ to $23\text{ V}$ $T_j = 25\text{ }^\circ\text{C}$			250 200	mV mV
$\Delta V_o$	Load Regulation	$I_o = 1$ to $100\text{ mA}$ $T_j = 25\text{ }^\circ\text{C}$ $I_o = 1$ to $40\text{ mA}$ $T_j = 25\text{ }^\circ\text{C}$			80 40	mV mV
$I_d$	Quiescent Current	$T_j = 25\text{ }^\circ\text{C}$ $T_j = 125\text{ }^\circ\text{C}$			6 5.5	mA mA
$\Delta I_d$	Quiescent Current Change	$I_o = 1$ to $40\text{ mA}$			0.2	mA
$\Delta I_d$	Quiescent Current Change	$V_i = 12$ to $23\text{ V}$			1.5	mA
eN	Output Noise Voltage	$B = 10\text{Hz}$ to $100\text{KHz}$ $T_j = 25\text{ }^\circ\text{C}$		70		$\mu\text{V}$
SVR	Supply Voltage Rejection	$I_o = 40\text{ mA}$ $f = 120\text{ Hz}$ $T_j = 25\text{ }^\circ\text{C}$ $V_i = 12$ to $23\text{ V}$	36	44		dB
$V_d$	Dropout Voltage			1.7		V

## L78L00 SERIES

**ELECTRICAL CHARACTERISTICS FOR L78L12** (refer to the test circuits,  $T_j = 0$  to  $125$  °C,  $V_i = 19$ V,  $I_o = 40$  mA,  $C_i = 0.33$   $\mu$ F,  $C_o = 0.1$   $\mu$ F unless otherwise specified)

Symbol	Parameter	Test Conditions	Min.	Typ.	Max.	Unit
$V_o$	Output Voltage	$T_j = 25$ °C	11.1	12	12.9	V
$V_o$	Output Voltage	$I_o = 1$ to $40$ mA $V_i = 14.5$ to $27$ V $I_o = 1$ to $70$ mA $V_i = 19$ V	10.8 10.8		13.2 13.2	V V
$\Delta V_o$	Line Regulation	$V_i = 14.5$ to $27$ V $T_j = 25$ °C $V_i = 16$ to $27$ V $T_j = 25$ °C			250 200	mV mV
$\Delta V_o$	Load Regulation	$I_o = 1$ to $100$ mA $T_j = 25$ °C $I_o = 1$ to $40$ mA $T_j = 25$ °C			100 50	mV mV
$I_d$	Quiescent Current	$T_j = 25$ °C $T_j = 125$ °C			6.5 6	mA mA
$\Delta I_d$	Quiescent Current Change	$I_o = 1$ to $40$ mA			0.2	mA
$\Delta I_d$	Quiescent Current Change	$V_i = 16$ to $27$ V			1.5	mA
eN	Output Noise Voltage	$B = 10$ Hz to $100$ KHz $T_j = 25$ °C		80		$\mu$ V
SVR	Supply Voltage Rejection	$I_o = 40$ mA $f = 120$ Hz $T_j = 25$ °C $V_i = 15$ to $25$ V	36	42		dB
$V_d$	Dropout Voltage			1.7		V

**ELECTRICAL CHARACTERISTICS FOR L78L15** (refer to the test circuits,  $T_j = 0$  to  $125$  °C,  $V_i = 23$ V,  $I_o = 40$  mA,  $C_i = 0.33$   $\mu$ F,  $C_o = 0.1$   $\mu$ F unless otherwise specified)

Symbol	Parameter	Test Conditions	Min.	Typ.	Max.	Unit
$V_o$	Output Voltage	$T_j = 25$ °C	13.8	15	16.2	V
$V_o$	Output Voltage	$I_o = 1$ to $40$ mA $V_i = 17.5$ to $30$ V $I_o = 1$ to $70$ mA $V_i = 23$ V	13.5 13.5		16.5 16.5	V V
$\Delta V_o$	Line Regulation	$V_i = 17.5$ to $30$ V $T_j = 25$ °C $V_i = 20$ to $30$ V $T_j = 25$ °C			300 250	mV mV
$\Delta V_o$	Load Regulation	$I_o = 1$ to $100$ mA $T_j = 25$ °C $I_o = 1$ to $40$ mA $T_j = 25$ °C			150 75	mV mV
$I_d$	Quiescent Current	$T_j = 25$ °C $T_j = 125$ °C			6.5 6	mA mA
$\Delta I_d$	Quiescent Current Change	$I_o = 1$ to $40$ mA			0.2	mA
$\Delta I_d$	Quiescent Current Change	$V_i = 20$ to $30$ V			1.5	mA
eN	Output Noise Voltage	$B = 10$ Hz to $100$ KHz $T_j = 25$ °C		90		$\mu$ V
SVR	Supply Voltage Rejection	$I_o = 40$ mA $f = 120$ Hz $T_j = 25$ °C $V_i = 18.5$ to $28.5$ V	33	39		dB
$V_d$	Dropout Voltage			1.7		V

**ELECTRICAL CHARACTERISTICS FOR L78L18** (refer to the test circuits,  $T_j = 0$  to  $125$  °C,  $V_i = 27V$ ,  $I_o = 40$  mA,  $C_i = 0.33$   $\mu F$ ,  $C_o = 0.1$   $\mu F$  unless otherwise specified)

Symbol	Parameter	Test Conditions	Min.	Typ.	Max.	Unit
$V_o$	Output Voltage	$T_j = 25$ °C	16.6	18	19.4	V
$V_o$	Output Voltage	$I_o = 1$ to $40$ mA $V_i = 22$ to $33$ V $I_o = 1$ to $70$ mA $V_i = 27$ V	16.2 16.2		19.8 19.8	V V
$\Delta V_o$	Line Regulation	$V_i = 22$ to $33$ V $T_j = 25$ °C $V_i = 22$ to $33$ V $T_j = 25$ °C			320 270	mV mV
$\Delta V_o$	Load Regulation	$I_o = 1$ to $100$ mA $T_j = 25$ °C $I_o = 1$ to $40$ mA $T_j = 25$ °C			170 85	mV mV
$I_d$	Quiescent Current	$T_j = 25$ °C $T_j = 125$ °C			6.5 6	mA mA
$\Delta I_d$	Quiescent Current Change	$I_o = 1$ to $40$ mA			0.2	mA
$\Delta I_d$	Quiescent Current Change	$V_i = 23$ to $33$ V			1.5	mA
eN	Output Noise Voltage	$B = 10$ Hz to $100$ KHz $T_j = 25$ °C		120		$\mu$ V
SVR	Supply Voltage Rejection	$I_o = 40$ mA $f = 120$ Hz $T_j = 25$ °C $V_i = 23$ to $33$ V	32	38		dB
$V_d$	Dropout Voltage			1.7		V

**ELECTRICAL CHARACTERISTICS FOR L78L24** (refer to the test circuits,  $T_j = 0$  to  $125$  °C,  $V_i = 33V$ ,  $I_o = 40$  mA,  $C_i = 0.33$   $\mu F$ ,  $C_o = 0.1$   $\mu F$  unless otherwise specified)

Symbol	Parameter	Test Conditions	Min.	Typ.	Max.	Unit
$V_o$	Output Voltage	$T_j = 25$ °C	22.1	24	25.9	V
$V_o$	Output Voltage	$I_o = 1$ to $40$ mA $V_i = 27$ to $38$ V $I_o = 1$ to $70$ mA $V_i = 33$ V	21.6 21.6		26.4 26.4	V V
$\Delta V_o$	Line Regulation	$V_i = 27$ to $38$ V $T_j = 25$ °C $V_i = 28$ to $38$ V $T_j = 25$ °C			350 300	mV mV
$\Delta V_o$	Load Regulation	$I_o = 1$ to $100$ mA $T_j = 25$ °C $I_o = 1$ to $40$ mA $T_j = 25$ °C			200 100	mV mV
$I_d$	Quiescent Current	$T_j = 25$ °C $T_j = 125$ °C			6.5 6	mA mA
$\Delta I_d$	Quiescent Current Change	$I_o = 1$ to $40$ mA			0.2	mA
$\Delta I_d$	Quiescent Current Change	$V_i = 28$ to $38$ V			1.5	mA
eN	Output Noise Voltage	$B = 10$ Hz to $100$ KHz $T_j = 25$ °C		200		$\mu$ V
SVR	Supply Voltage Rejection	$I_o = 40$ mA $f = 120$ Hz $T_j = 25$ °C $V_i = 29$ to $35$ V	30	37		dB
$V_d$	Dropout Voltage			1.7		V

## L78L00 SERIES

### ELECTRICAL CHARACTERISTICS FOR L78L05AB AND L78L05AC

(refer to the test circuits,  $V_i = 10V$ ,  $I_o = 40$  mA,  $C_i = 0.33$   $\mu F$ ,  $C_o = 0.1$   $\mu F$ ,  $T_j = 0$  to  $125$   $^{\circ}C$  for L78L05AC,  $T_j = -40$  to  $125$   $^{\circ}C$  for L78L05AB, unless otherwise specified)

Symbol	Parameter	Test Conditions	Min.	Typ.	Max.	Unit
$V_o$	Output Voltage	$T_j = 25$ $^{\circ}C$	4.8	5	5.2	V
$V_o$	Output Voltage	$I_o = 1$ to $40$ mA $V_i = 7$ to $20$ V $I_o = 1$ to $70$ mA $V_i = 10$ V	4.75 4.75		5.25 5.25	V V
$\Delta V_o$	Line Regulation	$V_i = 7$ to $20$ V $T_j = 25$ $^{\circ}C$ $V_i = 8$ to $20$ V $T_j = 25$ $^{\circ}C$			150 100	mV mV
$\Delta V_o$	Load Regulation	$I_o = 1$ to $100$ mA $T_j = 25$ $^{\circ}C$ $I_o = 1$ to $40$ mA $T_j = 25$ $^{\circ}C$			60 30	mV mV
$I_d$	Quiescent Current	$T_j = 25$ $^{\circ}C$ $T_j = 125$ $^{\circ}C$			6 5.5	mA mA
$\Delta I_d$	Quiescent Current Change	$I_o = 1$ to $40$ mA			0.1	mA
$\Delta I_d$	Quiescent Current Change	$V_i = 8$ to $20$ V			1.5	mA
eN	Output Noise Voltage	$B = 10$ Hz to $100$ KHz $T_j = 25$ $^{\circ}C$		40		$\mu V$
SVR	Supply Voltage Rejection	$I_o = 40$ mA $f = 120$ Hz $T_j = 25$ $^{\circ}C$ $V_i = 8$ to $18$ V	41	49		dB
$V_d$	Dropout Voltage			1.7		V

### ELECTRICAL CHARACTERISTICS FOR L78L06AB AND L78L06AC

(refer to the test circuits,  $V_i = 12V$ ,  $I_o = 40$  mA,  $C_i = 0.33$   $\mu F$ ,  $C_o = 0.1$   $\mu F$ ,  $T_j = 0$  to  $125$   $^{\circ}C$  for L78L06AC,  $T_j = -40$  to  $125$   $^{\circ}C$  for L78L06AB, unless otherwise specified)

Symbol	Parameter	Test Conditions	Min.	Typ.	Max.	Unit
$V_o$	Output Voltage	$T_j = 25$ $^{\circ}C$	5.76	6	6.24	V
$V_o$	Output Voltage	$I_o = 1$ to $40$ mA $V_i = 8.5$ to $20$ V $I_o = 1$ to $70$ mA $V_i = 12$ V	5.7 5.7		6.3 6.3	V V
$\Delta V_o$	Line Regulation	$V_i = 8.5$ to $20$ V $T_j = 25$ $^{\circ}C$ $V_i = 9$ to $20$ V $T_j = 25$ $^{\circ}C$			150 100	mV mV
$\Delta V_o$	Load Regulation	$I_o = 1$ to $100$ mA $T_j = 25$ $^{\circ}C$ $I_o = 1$ to $40$ mA $T_j = 25$ $^{\circ}C$			60 30	mV mV
$I_d$	Quiescent Current	$T_j = 25$ $^{\circ}C$ $T_j = 125$ $^{\circ}C$			6 5.5	mA mA
$\Delta I_d$	Quiescent Current Change	$I_o = 1$ to $40$ mA			0.1	mA
$\Delta I_d$	Quiescent Current Change	$V_i = 9$ to $20$ V			1.5	mA
eN	Output Noise Voltage	$B = 10$ Hz to $100$ KHz $T_j = 25$ $^{\circ}C$		50		$\mu V$
SVR	Supply Voltage Rejection	$I_o = 40$ mA $f = 120$ Hz $T_j = 25$ $^{\circ}C$ $V_i = 9$ to $20$ V	39	46		dB
$V_d$	Dropout Voltage			1.7		V



**ELECTRICAL CHARACTERISTICS FOR L78L08AB AND L78L08AC**

(refer to the test circuits,  $V_i = 14V$ ,  $I_o = 40\text{ mA}$ ,  $C_i = 0.33\ \mu F$ ,  $C_o = 0.1\ \mu F$ ,  $T_j = 0\text{ to }125\ ^\circ C$  for L78L08AC,  $T_j = -40\text{ to }125\ ^\circ C$  for L78L08AB, unless otherwise specified)

Symbol	Parameter	Test Conditions	Min.	Typ.	Max.	Unit
$V_o$	Output Voltage	$T_j = 25\ ^\circ C$	7.68	8	8.32	V
$V_o$	Output Voltage	$I_o = 1\text{ to }40\text{ mA}$ $V_i = 10.5\text{ to }23\text{ V}$ $I_o = 1\text{ to }70\text{ mA}$ $V_i = 14\text{ V}$	7.6 7.6		8.4 8.4	V V
$\Delta V_o$	Line Regulation	$V_i = 10.5\text{ to }23\text{ V}$ $T_j = 25\ ^\circ C$ $V_i = 11\text{ to }23\text{ V}$ $T_j = 25\ ^\circ C$			175 125	mV mV
$\Delta V_o$	Load Regulation	$I_o = 1\text{ to }100\text{ mA}$ $T_j = 25\ ^\circ C$ $I_o = 1\text{ to }40\text{ mA}$ $T_j = 25\ ^\circ C$			80 40	mV mV
$I_d$	Quiescent Current	$T_j = 25\ ^\circ C$ $T_j = 125\ ^\circ C$			6 5.5	mA mA
$\Delta I_d$	Quiescent Current Change	$I_o = 1\text{ to }40\text{ mA}$			0.1	mA
$\Delta I_d$	Quiescent Current Change	$V_i = 11\text{ to }23\text{ V}$			1.5	mA
eN	Output Noise Voltage	$B = 10\text{Hz to }100\text{KHz}$ $T_j = 25\ ^\circ C$		60		$\mu V$
SVR	Supply Voltage Rejection	$I_o = 40\text{ mA}$ $f = 120\text{ Hz}$ $T_j = 25\ ^\circ C$ $V_i = 12\text{ to }23\text{ V}$	37	45		dB
$V_d$	Dropout Voltage			1.7		V

**ELECTRICAL CHARACTERISTICS FOR L78L09AB AND L78L09AC**

(refer to the test circuits,  $V_i = 15V$ ,  $I_o = 40\text{ mA}$ ,  $C_i = 0.33\ \mu F$ ,  $C_o = 0.1\ \mu F$ ,  $T_j = 0\text{ to }125\ ^\circ C$  for L78L09AC,  $T_j = -40\text{ to }125\ ^\circ C$  for L78L09AB, unless otherwise specified)

Symbol	Parameter	Test Conditions	Min.	Typ.	Max.	Unit
$V_o$	Output Voltage	$T_j = 25\ ^\circ C$	8.64	9	9.36	V
$V_o$	Output Voltage	$I_o = 1\text{ to }40\text{ mA}$ $V_i = 11.5\text{ to }23\text{ V}$ $I_o = 1\text{ to }70\text{ mA}$ $V_i = 15\text{ V}$	8.55 8.55		9.45 9.45	V V
$\Delta V_o$	Line Regulation	$V_i = 11.5\text{ to }23\text{ V}$ $T_j = 25\ ^\circ C$ $V_i = 12\text{ to }23\text{ V}$ $T_j = 25\ ^\circ C$			225 150	mV mV
$\Delta V_o$	Load Regulation	$I_o = 1\text{ to }100\text{ mA}$ $T_j = 25\ ^\circ C$ $I_o = 1\text{ to }40\text{ mA}$ $T_j = 25\ ^\circ C$			80 40	mV mV
$I_d$	Quiescent Current	$T_j = 25\ ^\circ C$ $T_j = 125\ ^\circ C$			6 5.5	mA mA
$\Delta I_d$	Quiescent Current Change	$I_o = 1\text{ to }40\text{ mA}$			0.1	mA
$\Delta I_d$	Quiescent Current Change	$V_i = 12\text{ to }23\text{ V}$			1.5	mA
eN	Output Noise Voltage	$B = 10\text{Hz to }100\text{KHz}$ $T_j = 25\ ^\circ C$		70		$\mu V$
SVR	Supply Voltage Rejection	$I_o = 40\text{ mA}$ $f = 120\text{ Hz}$ $T_j = 25\ ^\circ C$ $V_i = 12\text{ to }23\text{ V}$	37	44		dB
$V_d$	Dropout Voltage			1.7		V

## L78L00 SERIES

### ELECTRICAL CHARACTERISTICS FOR L78L12AB AND L78L12AC

(refer to the test circuits,  $V_i = 19V$ ,  $I_o = 40$  mA,  $C_i = 0.33$   $\mu F$ ,  $C_o = 0.1$   $\mu F$ ,  $T_j = 0$  to  $125$   $^{\circ}C$  for L78L12AC,  $T_j = -40$  to  $125$   $^{\circ}C$  for L78L12AB, unless otherwise specified)

Symbol	Parameter	Test Conditions	Min.	Typ.	Max.	Unit
$V_o$	Output Voltage	$T_j = 25$ $^{\circ}C$	11.5	12	12.5	V
$V_o$	Output Voltage	$I_o = 1$ to $40$ mA $V_i = 14.5$ to $27$ V $I_o = 1$ to $70$ mA $V_i = 19$ V	11.4 11.4		12.6 12.6	V V
$\Delta V_o$	Line Regulation	$V_i = 14.5$ to $27$ V $T_j = 25$ $^{\circ}C$ $V_i = 16$ to $27$ V $T_j = 25$ $^{\circ}C$			250 200	mV mV
$\Delta V_o$	Load Regulation	$I_o = 1$ to $100$ mA $T_j = 25$ $^{\circ}C$ $I_o = 1$ to $40$ mA $T_j = 25$ $^{\circ}C$			100 50	mV mV
$I_d$	Quiescent Current	$T_j = 25$ $^{\circ}C$ $T_j = 125$ $^{\circ}C$			6.5 6	mA mA
$\Delta I_d$	Quiescent Current Change	$I_o = 1$ to $40$ mA			0.1	mA
$\Delta I_d$	Quiescent Current Change	$V_i = 16$ to $27$ V			1.5	mA
eN	Output Noise Voltage	$B = 10$ Hz to $100$ KHz $T_j = 25$ $^{\circ}C$		80		$\mu V$
SVR	Supply Voltage Rejection	$I_o = 40$ mA $f = 120$ Hz $T_j = 25$ $^{\circ}C$ $V_i = 15$ to $25$ V	37	42		dB
$V_d$	Dropout Voltage			1.7		V

### ELECTRICAL CHARACTERISTICS FOR L78L15AB AND L78L15AC

(refer to the test circuits,  $V_i = 23V$ ,  $I_o = 40$  mA,  $C_i = 0.33$   $\mu F$ ,  $C_o = 0.1$   $\mu F$ ,  $T_j = 0$  to  $125$   $^{\circ}C$  for L78L15AC,  $T_j = -40$  to  $125$   $^{\circ}C$  for L78L15AB, unless otherwise specified)

Symbol	Parameter	Test Conditions	Min.	Typ.	Max.	Unit
$V_o$	Output Voltage	$T_j = 25$ $^{\circ}C$	14.4	15	15.6	V
$V_o$	Output Voltage	$I_o = 1$ to $40$ mA $V_i = 17.5$ to $30$ V $I_o = 1$ to $70$ mA $V_i = 23$ V	14.25 14.25		15.75 15.75	V V
$\Delta V_o$	Line Regulation	$V_i = 17.5$ to $30$ V $T_j = 25$ $^{\circ}C$ $V_i = 20$ to $30$ V $T_j = 25$ $^{\circ}C$			300 250	mV mV
$\Delta V_o$	Load Regulation	$I_o = 1$ to $100$ mA $T_j = 25$ $^{\circ}C$ $I_o = 1$ to $40$ mA $T_j = 25$ $^{\circ}C$			150 75	mV mV
$I_d$	Quiescent Current	$T_j = 25$ $^{\circ}C$ $T_j = 125$ $^{\circ}C$			6.5 6	mA mA
$\Delta I_d$	Quiescent Current Change	$I_o = 1$ to $40$ mA			0.1	mA
$\Delta I_d$	Quiescent Current Change	$V_i = 20$ to $30$ V			1.5	mA
eN	Output Noise Voltage	$B = 10$ Hz to $100$ KHz $T_j = 25$ $^{\circ}C$		90		$\mu V$
SVR	Supply Voltage Rejection	$I_o = 40$ mA $f = 120$ Hz $T_j = 25$ $^{\circ}C$ $V_i = 18.5$ to $28.5$ V	34	39		dB
$V_d$	Dropout Voltage			1.7		V

**ELECTRICAL CHARACTERISTICS FOR L78L18AB AND L78L18AC**

(refer to the test circuits,  $V_i = 27V$ ,  $I_o = 40$  mA,  $C_i = 0.33$   $\mu F$ ,  $C_o = 0.1$   $\mu F$ ,  $T_j = 0$  to  $125$   $^{\circ}C$  for L78L18AC,  $T_j = -40$  to  $125$   $^{\circ}C$  for L78L18AB, unless otherwise specified)

Symbol	Parameter	Test Conditions	Min.	Typ.	Max.	Unit
$V_o$	Output Voltage	$T_j = 25$ $^{\circ}C$	17.3	18	18.7	V
$V_o$	Output Voltage	$I_o = 1$ to $40$ mA $V_i = 22$ to $33$ V	17.1		18.9	V
$V_o$	Output Voltage	$I_o = 1$ to $70$ mA $V_i = 27$ V	17.1		18.9	V
$\Delta V_o$	Line Regulation	$V_i = 22$ to $33$ V $T_j = 25$ $^{\circ}C$			320	mV
$\Delta V_o$	Line Regulation	$V_i = 22$ to $33$ V $T_j = 25$ $^{\circ}C$			270	mV
$\Delta V_o$	Load Regulation	$I_o = 1$ to $100$ mA $T_j = 25$ $^{\circ}C$			170	mV
$\Delta V_o$	Load Regulation	$I_o = 1$ to $40$ mA $T_j = 25$ $^{\circ}C$			85	mV
$I_d$	Quiescent Current	$T_j = 25$ $^{\circ}C$			6.5	mA
$I_d$	Quiescent Current	$T_j = 125$ $^{\circ}C$			6	mA
$\Delta I_d$	Quiescent Current Change	$I_o = 1$ to $40$ mA			0.1	mA
$\Delta I_d$	Quiescent Current Change	$V_i = 23$ to $33$ V			1.5	mA
eN	Output Noise Voltage	$B = 10$ Hz to $100$ KHz $T_j = 25$ $^{\circ}C$		120		$\mu V$
SVR	Supply Voltage Rejection	$I_o = 40$ mA $f = 120$ Hz $T_j = 25$ $^{\circ}C$	33	38		dB
$V_d$	Dropout Voltage			1.7		V

**ELECTRICAL CHARACTERISTICS FOR L78L24AB AND L78L24AC**

(refer to the test circuits,  $V_i = 33V$ ,  $I_o = 40$  mA,  $C_i = 0.33$   $\mu F$ ,  $C_o = 0.1$   $\mu F$ ,  $T_j = 0$  to  $125$   $^{\circ}C$  for L78L24AC,  $T_j = -40$  to  $125$   $^{\circ}C$  for L78L24AB, unless otherwise specified)

Symbol	Parameter	Test Conditions	Min.	Typ.	Max.	Unit
$V_o$	Output Voltage	$T_j = 25$ $^{\circ}C$	23	24	25	V
$V_o$	Output Voltage	$I_o = 1$ to $40$ mA $V_i = 27$ to $38$ V	22.8		25.2	V
$V_o$	Output Voltage	$I_o = 1$ to $70$ mA $V_i = 33$ V	22.8		25.2	V
$\Delta V_o$	Line Regulation	$V_i = 27$ to $38$ V $T_j = 25$ $^{\circ}C$			350	mV
$\Delta V_o$	Line Regulation	$V_i = 28$ to $38$ V $T_j = 25$ $^{\circ}C$			300	mV
$\Delta V_o$	Load Regulation	$I_o = 1$ to $100$ mA $T_j = 25$ $^{\circ}C$			200	mV
$\Delta V_o$	Load Regulation	$I_o = 1$ to $40$ mA $T_j = 25$ $^{\circ}C$			100	mV
$I_d$	Quiescent Current	$T_j = 25$ $^{\circ}C$			6.5	mA
$I_d$	Quiescent Current	$T_j = 125$ $^{\circ}C$			6	mA
$\Delta I_d$	Quiescent Current Change	$I_o = 1$ to $40$ mA			0.1	mA
$\Delta I_d$	Quiescent Current Change	$V_i = 28$ to $38$ V			1.5	mA
eN	Output Noise Voltage	$B = 10$ Hz to $100$ KHz $T_j = 25$ $^{\circ}C$		200		$\mu V$
SVR	Supply Voltage Rejection	$I_o = 40$ mA $f = 120$ Hz $T_j = 25$ $^{\circ}C$	31	37		dB
$V_d$	Dropout Voltage			1.7		V

# L78L00 SERIES

**Figure 1:** L78L05/12 Output Voltage vs Ambient Temperature

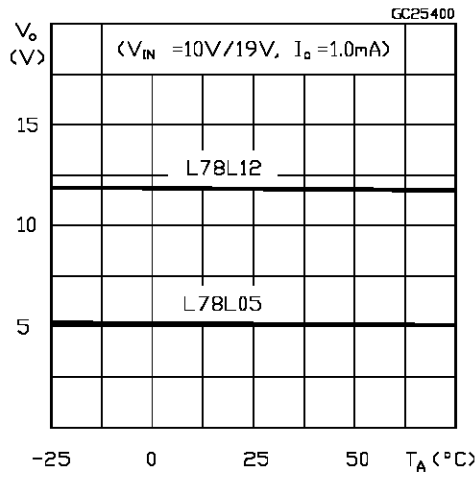

**Figure 2:** L78L05/12/24 Load Characteristics.

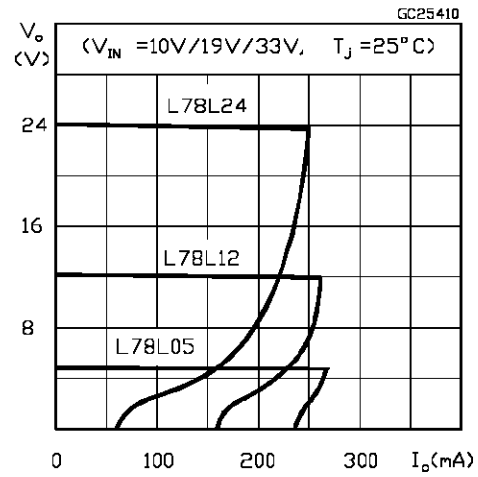

**Figure 3:** L78L05/12/24 Thermal Shutdown.

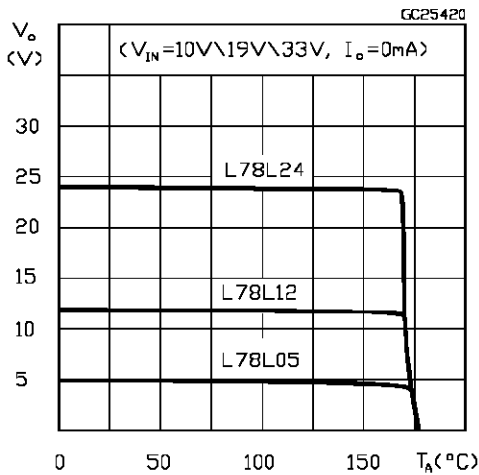

**Figure 4:** L78L05/12 Quiescent Current vs Output Current

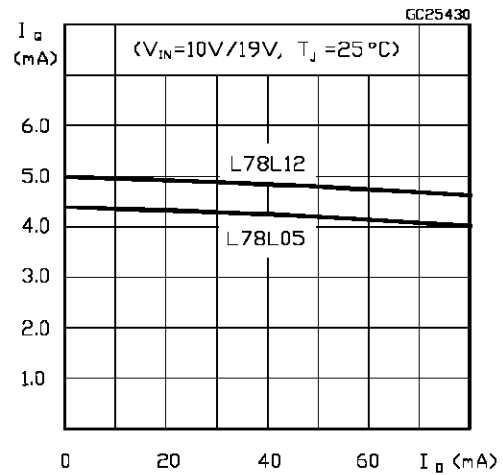

**Figure 5:** L78L05 Quiescent Current vs Input Voltage

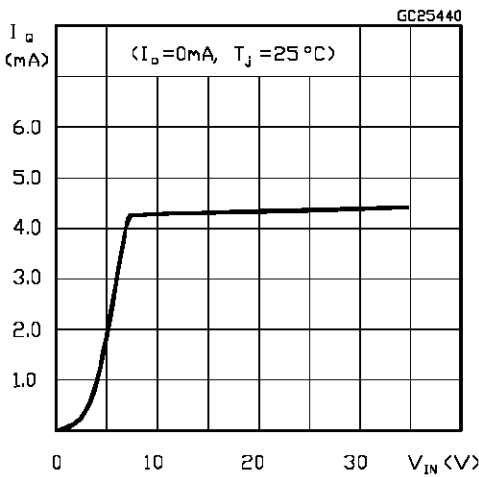

**Figure 6:** L78L05/12/24 Output Characteristics.

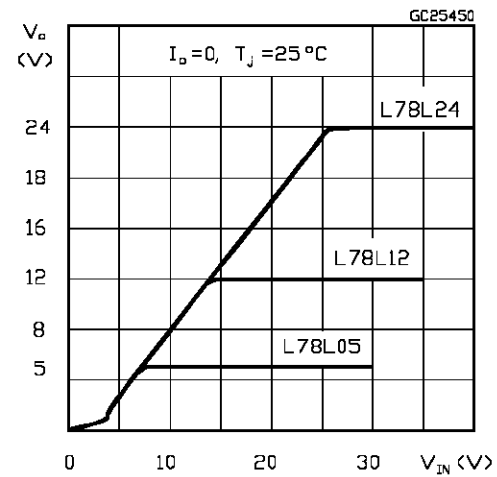

Figure 7 : L78L05/12/24 Ripple Rejection.

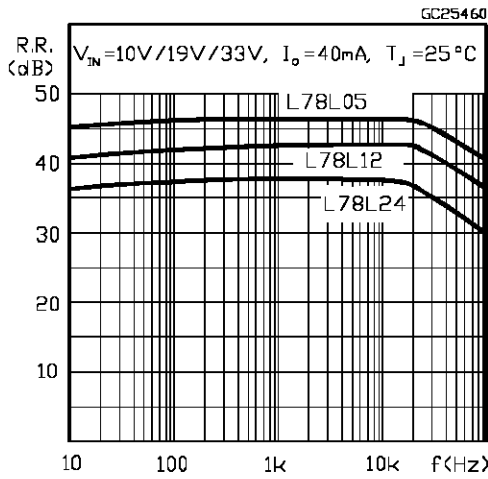

Figure 8 : L78L05 Dropout Characteristics.

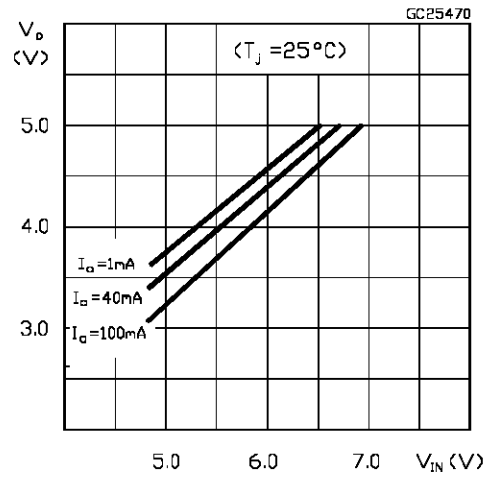
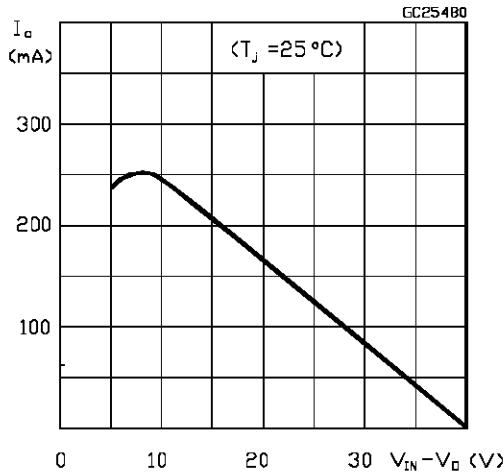
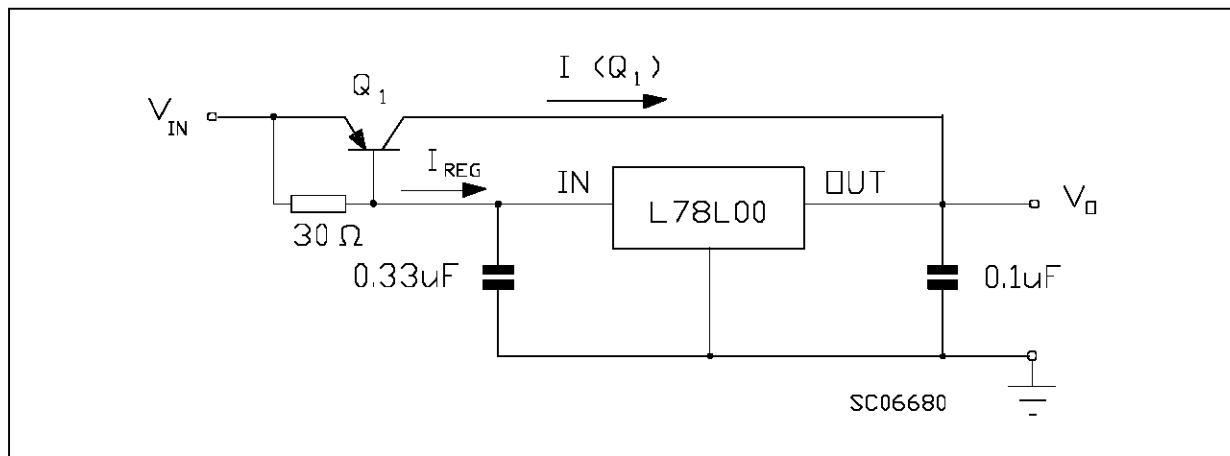

Figure 9 : L78L00 Series Short Circuit Output Current.



TYPICAL APPLICATIONS:

Figure 10: High Output Current Short Circuit Protected



## L78L00 SERIES

Figure 11 : Output Boost Circuit.

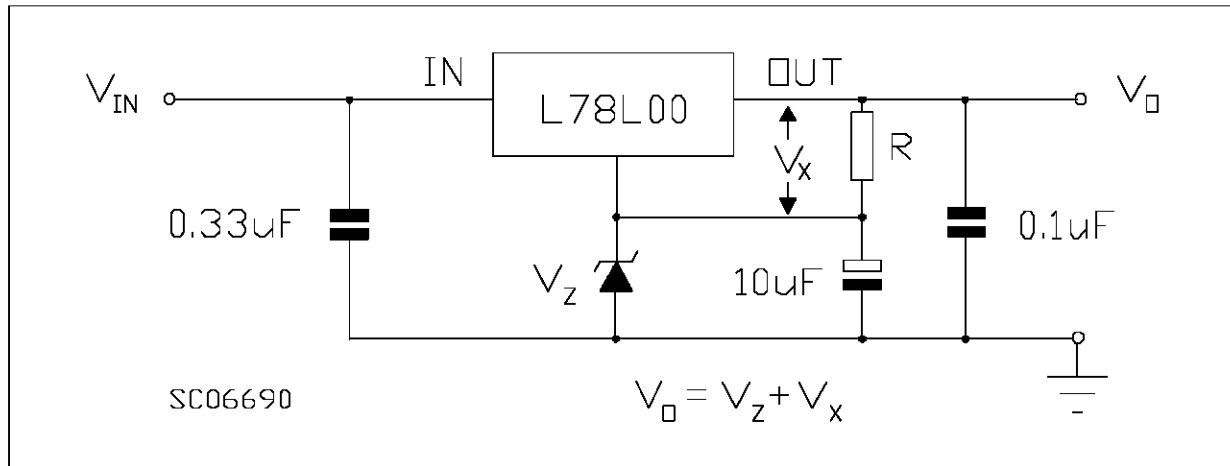

Figure 12 : Current Regulator.

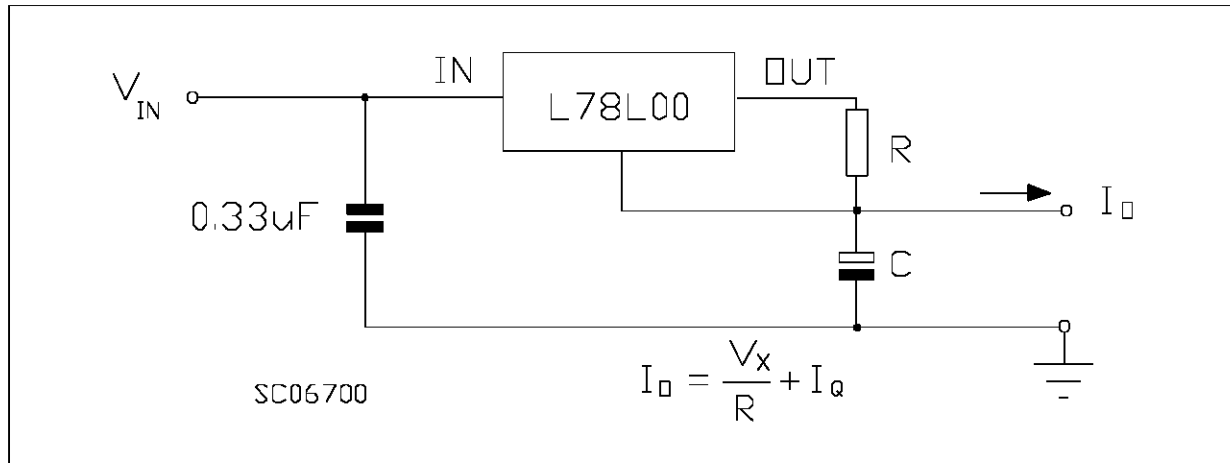
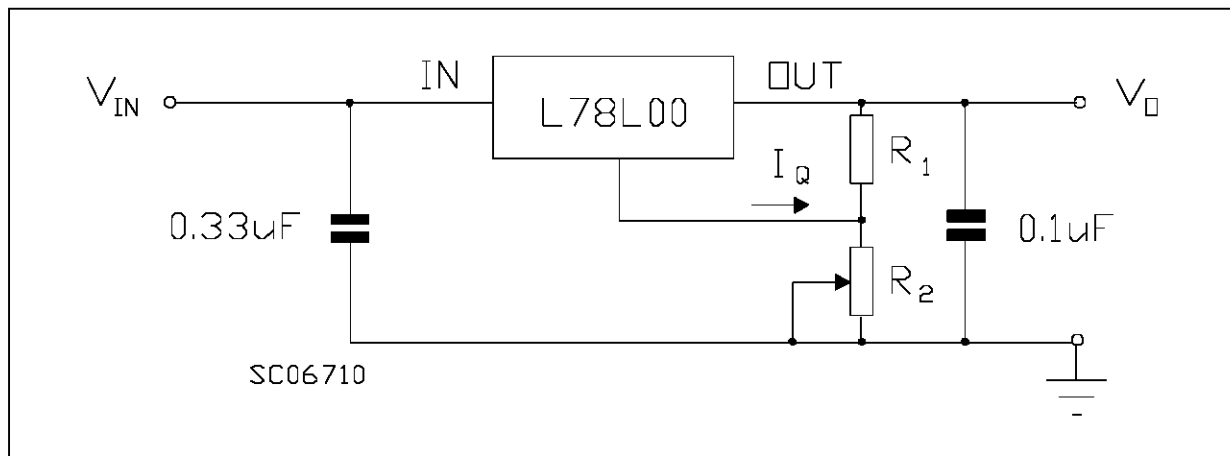
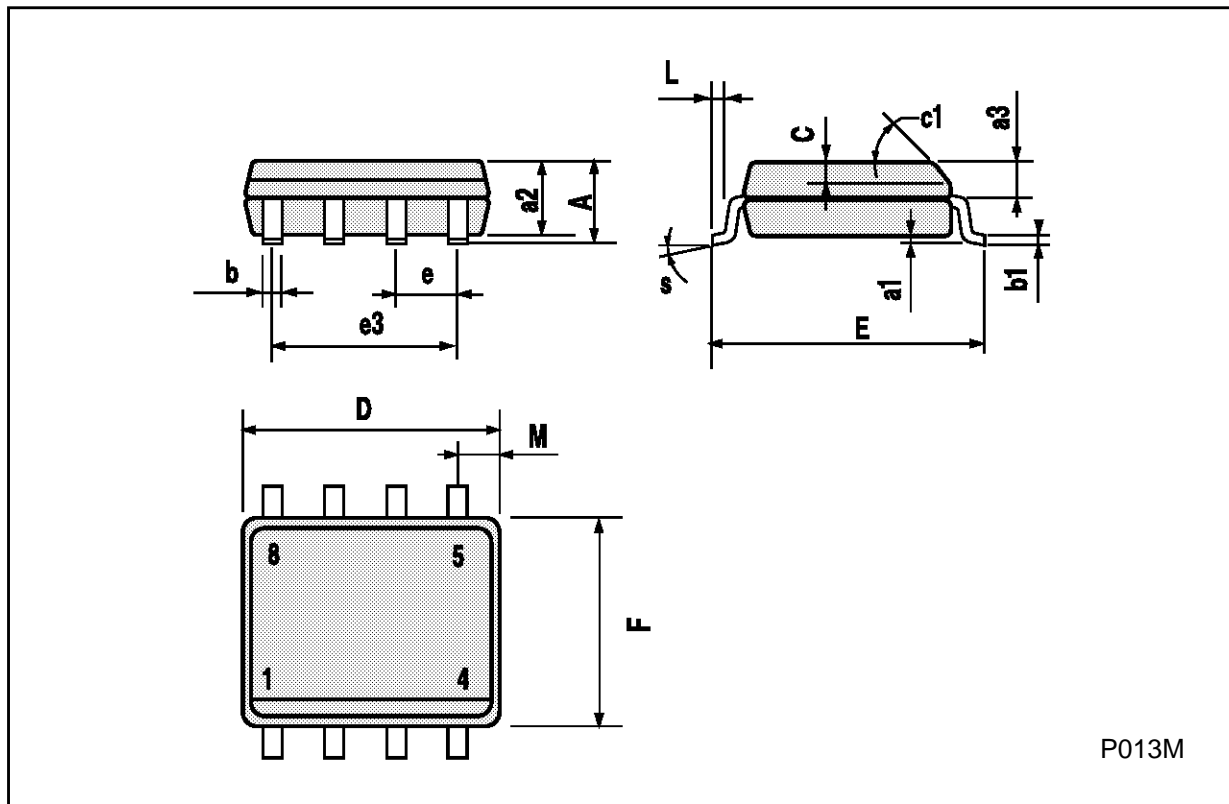

Figure 13: Adjustable Output Regulator



**SO8 MECHANICAL DATA**

DIM.	mm			inch		
	MIN.	TYP.	MAX.	MIN.	TYP.	MAX.
A			1.75			0.068
a1	0.1		0.25	0.003		0.009
a2			1.65			0.064
a3	0.65		0.85	0.025		0.033
b	0.35		0.48	0.013		0.018
b1	0.19		0.25	0.007		0.010
C	0.25		0.5	0.010		0.019
c1	45° (typ.)					
D	4.8		5.0	0.188		0.196
E	5.8		6.2	0.228		0.244
e		1.27			0.050	
e3		3.81			0.150	
F	3.8		4.0	0.14		0.157
L	0.4		1.27	0.015		0.050
M			0.6			0.023
S	8° (max.)					



P013M

# L78L00 SERIES

## TO-92 MECHANICAL DATA

DIM.	mm			inch		
	MIN.	TYP.	MAX.	MIN.	TYP.	MAX.
A	4.58		5.33	0.180		0.210
B	4.45		5.2	0.175		0.204
C	3.2		4.2	0.126		0.165
D	12.7			0.500		
E		1.27			0.050	
F	0.4		0.51	0.016		0.020
G	0.35			0.14		

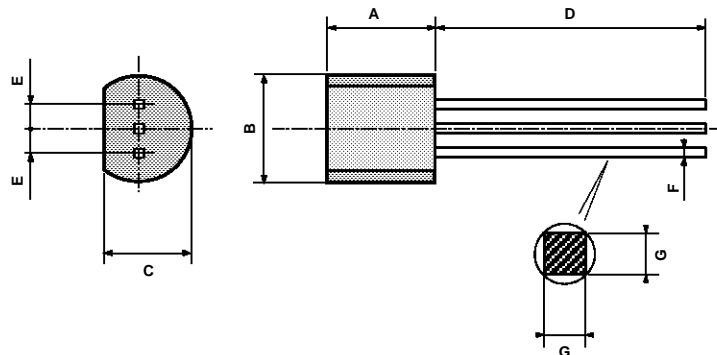



Information furnished is believed to be accurate and reliable. However, SGS-THOMSON Microelectronics assumes no responsibility for the consequences of use of such information nor for any infringement of patents or other rights of third parties which may result from its use. No license is granted by implication or otherwise under any patent or patent rights of SGS-THOMSON Microelectronics. Specifications mentioned in this publication are subject to change without notice. This publication supersedes and replaces all information previously supplied. SGS-THOMSON Microelectronics products are not authorized for use as critical components in life support devices or systems without express written approval of SGS-THOMSON Microelectronics.

© 1994 SGS-THOMSON Microelectronics - All Rights Reserved

SGS-THOMSON Microelectronics GROUP OF COMPANIES

Australia - Brazil - France - Germany - Hong Kong - Italy - Japan - Korea - Malaysia - Malta - Morocco - The Netherlands -  
Singapore - Spain - Sweden - Switzerland - Taiwan - Thailand - United Kingdom - U.S.A