

DESCRIPTION

The MCS1802 is a linear Hall-effect current sensor for AC or DC current sensing. The Hall array is differential, which cancels out any stray magnetic field.

A primary conductor with a low resistance allows current to flow close to the IC, which contains high-accuracy Hall-effect sensors. This current generates a magnetic field that is sensed at two different points by the integrated Hall-effect transducers. The magnetic field difference between these two points is then converted into a voltage that is proportional to the applied current. A spinning current technique is used for a low stable offset.

The galvanic isolation between the pins of the primary conductive path and the sensor leads allows the MCS1802 to replace opto-isolators or other isolation devices.

The MCS1802 requires a minimal number of readily available, standard external components. The device's small footprint saves board area and makes it well-suited for space-constrained applications. The MCS1802 is available in an SOIC-8 package.

FEATURES

- 3.3V Single Supply
- Immune to External Magnetic Fields by Differential Sensing
- 2.2kV_{RMS} Minimum Isolation Voltage
- Operating Temperature: -40°C to +125°C
- 0.9mΩ Internal Conductor Resistance
- 5A to 50A Range
- Adjustable Bandwidth up to 100kHz
- 4μs Output Rising Time
- Ratiometric Output from Supply Voltage
- Output Proportional to AC or DC Currents
- Factory-Trimmed for Accuracy
- No Magnetic Hysteresis
- Integrated Shield Suppressing Capacitive Coupling from Current Conductor to Die (Up to 10V/ns)
- Available in an SOIC-8 Package

APPLICATIONS

- Motor Control
- Automotive Systems
- Load Detection and Management
- Switch-Mode Power Supplies
- Over-Current Fault Protection

All MPS parts are lead-free, halogen-free, and adhere to the RoHS directive. For MPS green status, please visit the MPS website under Quality Assurance. "MPS", the MPS logo, and "Simple, Easy Solutions" are trademarks of Monolithic Power Systems, Inc. or its subsidiaries.

TYPICAL APPLICATION

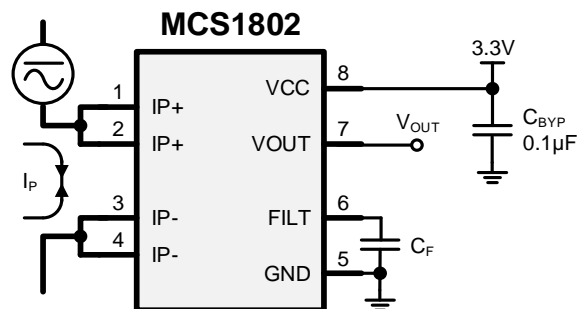

Note:

1) V_{OUT} is proportional to I_P within the specified range. The noise vs. bandwidth tradeoff can be adjusted by connecting a capacitor (C_F) between FILT and GND.

ORDERING INFORMATION

| Part Number* | Optimized Primary Current Range (A) | Typ Sensitivity (SENS)(mV/A) | Top Marking |
|---------------------|--|-------------------------------------|--------------------|
| MCS1802GS-05 | ±5 | 264 | MC180205 |
| MCS1802GS-10 | ±10 | 132 | MC180210 |
| MCS1802GS-20 | ±20 | 66 | MC180220 |
| MCS1802GS-30 | ±30 | 44 | MC180230 |
| MCS1802GS-40 | ±40 | 33 | MC180240 |
| MCS1802GS-50 | ±50 | 26.4 | MC180250 |

* For Tape & Reel, add suffix -Z (e.g. MCS1802GS-05-Z).

TOP MARKING (MCS1802GS-05)

MC180205
LLLLLLLLL
MPSYWW

MC180205: Part number
LLLLLLLLL: Lot number
MPS: MPS prefix
Y: Year code
WW: Week code

TOP MARKING (MCS1802GS-10)

MC180210
LLLLLLLLL
MPSYWW

MC180210: Part number
LLLLLLLLL: Lot number
MPS: MPS prefix
Y: Year code
WW: Week code

TOP MARKING (MCS1802GS-20)

MC180220
LLLLLLLLL
MPSYWW

MC180220: Part number
LLLLLLLLL: Lot number
MPS: MPS prefix
Y: Year code
WW: Week code

TOP MARKING (MCS1802GS-30)

MC180230
LLLLLLLLL
MPSYWW

MC180230: Part number
LLLLLLLLL: Lot number
MPS: MPS prefix
Y: Year code
WW: Week code

TOP MARKING (MCS1802GS-40)

MC180240
LLLLLLLLL
MPSYWW

MC180240: Part number
LLLLLLLLL: Lot number
MPS: MPS prefix
Y: Year code
WW: Week code

TOP MARKING (MCS1802GS-50)

MC180250

LLLLLLLL

MPSYWW

MC180250: Part number

LLLLLLLL: Lot number

MPS: MPS prefix

Y: Year code

WW: Week code

PACKAGE REFERENCE

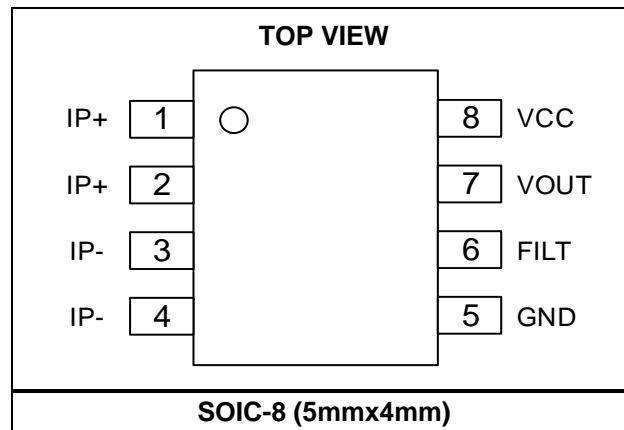

PIN FUNCTIONS

| Pin # | Name | Description |
|-------|------|--|
| 1, 2 | IP+ | Primary current (+). IP+ is a terminal for the current being sampled. These pins are internally connected together. |
| 3, 4 | IP- | Primary current (-). IP- is a terminal for the current being sampled. These pins are internally connected together. |
| 5 | GND | Ground. Signal ground terminal. |
| 6 | FILT | Filter. FILT is a terminal for the external capacitor (C_F), which sets the bandwidth. FLT can be left floating when the bandwidth setting is not required. |
| 7 | VOUT | Analog output. |
| 8 | VCC | Voltage supply. Connect VCC to a 3.3V power supply |

ABSOLUTE MAXIMUM RATINGS ⁽²⁾

| | |
|------------------------------|-----------------|
| Supply voltage (V_{CC}) | -0.1V to +6V |
| Output voltage (V_{OUT}) | -0.1V to +6V |
| V_{FILT} | -0.1V to +6V |
| Junction temperature | 165°C |
| Lead temperature | 260°C |
| Storage temperature | -65°C to +165°C |

ESD Ratings

| | |
|--------------------------------|-------------|
| Pin 6, Pin 7, and Pin 8 | |
| Human body model (HBM) | $\pm 2000V$ |
| Pin 5, Pin 6, Pin 7, and Pin 8 | |
| Charged device model (CDM) | $\pm 2000V$ |

Recommended Operating Conditions ⁽³⁾

| | |
|-----------------------------------|-----------------|
| Supply voltage (V_{CC}) | 3.0V to 3.6V |
| Operating junction temp (T_J) | -40°C to +125°C |

Notes:

- 2) Exceeding these ratings may damage the device.
- 3) The device is not guaranteed to function outside of its operating conditions.

ISOLATION CHARACTERISTICS

| Parameters | Symbol | Condition | Rating | Units |
|-----------------------------------|------------|---|--------|-----------------------|
| Withstand isolation voltage | V_{ISO} | Agency type-tested for 60 seconds in accordance with IEC62368-1. 100% Production tested at $1.2 \times V_{ISO}$ for 1 second. | 2200 | V_{RMS} |
| Maximum isolation working voltage | V_{IOWM} | Maximum approved working voltage for basic isolation, according to IEC62368-1. | 350 | V_{PK} |
| | | | 250 | V_{RMS} OR V_{DC} |
| External clearance | CLR | Shortest distance through the air from the IP leads to the signal leads. | 4.2 | mm |
| External creepage | CPG | Shortest distance along the package body from the IP leads to the signal leads. | 4.2 | mm |

MCS1802 COMMON ELECTRICAL CHARACTERISTICS ⁽⁴⁾

 Typical values are $V_{CC} = 3.3V$, $C_F = 0nF$, $C_L = 1nF$, $T_J = -40^{\circ}C$ to $+125^{\circ}C$, unless otherwise noted.

| Parameters | Symbol | Condition | Min | Typ | Max | Units |
|---|-------------------------------|---|----------------|--------------|------|---------------------------|
| Supply voltage | V_{CC} | | 3.0 | | 3.6 | V |
| VCC under-voltage lockout threshold | V_{CCUVLO} | V_{CC} rising | 2 | 2.5 | 3 | V |
| VCC under-voltage lockout hysteresis | V_{CCUVLO_HYS} | | | 400 | 750 | mV |
| Operating supply current | I_{CC} | $V_{CC} = 3.3V$ | | 8.5 | 10.5 | mA |
| Output capacitance load ⁽¹⁰⁾ | C_L | From VOUT to GND | | | 10 | nF |
| Output resistive load ⁽¹⁰⁾ | R_L | From VOUT to GND | 4.7 | | | k Ω |
| Primary conductor resistance ⁽¹²⁾ | R_P | Effective | | 0.9 | | m Ω |
| Frequency bandwidth ⁽¹⁰⁾ | f_{BW} | FILT unconnected | | 100 | | kHz |
| Internal filter resistance ⁽⁹⁾ | R_{Fi} | | | 1.5 | | k Ω |
| Internal filter capacitance ⁽⁹⁾ | C_{Fi} | | | 1 | | nF |
| Power-on time ⁽¹⁰⁾ | t_{PO} | $I_P = I_{PMAX}$, FILT unconnected | | 90 | | μs |
| Rise time ⁽¹⁰⁾ | t_R | $I_P = I_{PMAX}$, FILT unconnected | | 4 | | μs |
| Propagation delay ⁽¹⁰⁾ | t_{PD} | $I_P = I_{PMAX}$, FILT unconnected | | 1.5 | | μs |
| Response time ⁽¹⁰⁾ | $t_{RESPONSE}$ | $I_P = I_{PMAX}$, FILT unconnected | | 5 | | μs |
| Noise density ⁽¹⁰⁾ | I_{ND} | Input referenced noise density | | 200 | | $\mu A_{(RMS)}/\sqrt{Hz}$ |
| Noise ⁽¹⁰⁾ | I_N | Input referred, 1nF on FILT (60kHz bandwidth) | | 50 | | $mA_{(RMS)}$ |
| Nonlinearity ⁽¹⁰⁾ | E_{LIN} | Across the full I_P range | | 0.5 | | % |
| Ratiometry | K_{SENS} | $V_{CC} = 3.0$ to $3.6V$ | 98 | 100 | 102 | % |
| | K_{V0} | $V_{CC} = 3.0$ to $3.6V$, $I_P = 0A$ | 99 | 100 | 101 | % |
| Zero current output voltage | $V_{OUT(Q)}$ ($I_P = 0$) | $I_P = 0A$ | | $V_{CC} / 2$ | | V |
| First Hall magnetic coupling factor ⁽⁹⁾ | P_{MCF1} | | 1.1 | 1.2 | 1.3 | mT/A |
| Second Hall magnetic coupling factor ⁽⁹⁾ | P_{MCF2} | | 0.60 | 0.65 | 0.70 | mT/A |
| Hall plate matching ⁽¹⁰⁾ | M_H | | | ± 1 | | % |
| Saturation voltage ⁽⁵⁾ | $V_{OUT(H)}$ | $R_L = 4.7k\Omega$, $T_J = 25^{\circ}C$ | $V_{CC} - 0.3$ | | | V |
| | $V_{OUT(L)}$ | $R_L = 4.7k\Omega$, $T_J = 25^{\circ}C$ | | | 0.3 | V |

MCS1802-05 PERFORMANCE CHARACTERISTICS ⁽⁴⁾
 $V_{CC} = 3.3V$, $C_F = 0nF$, $C_L = 1nF$, $T_J = -40^{\circ}C$ to $+125^{\circ}C$, unless otherwise noted.

| Parameters | Symbol | Condition | Min | Typ ⁽¹¹⁾ | Max | Units |
|---|---------------|---|------|---------------------|------|-------|
| Optimized accuracy range ⁽⁶⁾ | I_P | | -5 | | +5 | A |
| Sensitivity | SENS | $-5A \leq I_P \leq +5A$, $T_J = 25^{\circ}C$ | | 264 | | mV/A |
| Sensitivity error | E_{SENS} | $I_P = 5A$, $T_J = 25^{\circ}C$ to $125^{\circ}C$ | -2 | | +2 | % |
| | | $I_P = 5A$, $T_J = -40^{\circ}C$ to $+25^{\circ}C$ | | ±1.5 | | % |
| Offset voltage ⁽⁷⁾ | V_{OE} | $I_P = 0A$, $T_J = 25^{\circ}C$ to $125^{\circ}C$ | -10 | | +10 | mV |
| | | $I_P = 0A$, $T_J = -40^{\circ}C$ to $+25^{\circ}C$ | | ±5 | | mV |
| Total output error ⁽⁸⁾ | E_{TOT} | $I_P = 5A$, $T_J = 25^{\circ}C$ to $125^{\circ}C$ | -2.5 | | +2.5 | % |
| | | $I_P = 5A$, $T_J = -40^{\circ}C$ to $+25^{\circ}C$ | | ±1.5 | | % |
| Sensitivity error lifetime drift ⁽¹⁰⁾ | $E_{SENS(D)}$ | | | ±1 | | % |
| Total output error lifetime drift ⁽¹⁰⁾ | $E_{TOT(D)}$ | | | ±1 | | % |

MCS1802-10 PERFORMANCE CHARACTERISTICS ⁽⁴⁾
 $V_{CC} = 3.3V$, $C_F = 0nF$, $C_L = 1nF$, $T_J = -40^{\circ}C$ to $+125^{\circ}C$, unless otherwise noted.

| Parameters | Symbol | Condition | Min | Typ ⁽¹¹⁾ | Max | Units |
|---|---------------|--|------|---------------------|------|-------|
| Optimized accuracy range ⁽⁶⁾ | I_P | | -10 | | +10 | A |
| Sensitivity | SENS | $-10A \leq I_P \leq +10A$, $T_J = 25^{\circ}C$ | | 132 | | mV/A |
| Sensitivity error | E_{SENS} | $I_P = 10A$, $T_J = 25^{\circ}C$ to $125^{\circ}C$ | -2 | | +2 | % |
| | | $I_P = 10A$, $T_J = -40^{\circ}C$ to $+25^{\circ}C$ | | ±1.5 | | % |
| Offset voltage ⁽⁷⁾ | V_{OE} | $I_P = 0A$, $T_J = 25^{\circ}C$ to $125^{\circ}C$ | -10 | | +10 | mV |
| | | $I_P = 0A$, $T_J = -40^{\circ}C$ to $+25^{\circ}C$ | | ±5 | | mV |
| Total output error ⁽⁸⁾ | E_{TOT} | $I_P = 10A$, $T_J = 25^{\circ}C$ to $125^{\circ}C$ | -2.5 | | +2.5 | % |
| | | $I_P = 10A$, $T_J = -40^{\circ}C$ to $+25^{\circ}C$ | | ±1.5 | | % |
| Sensitivity error lifetime drift ⁽¹⁰⁾ | $E_{SENS(D)}$ | | | ±1 | | % |
| Total output error lifetime drift ⁽¹⁰⁾ | $E_{TOT(D)}$ | | | ±1 | | % |

MCS1802-20 PERFORMANCE CHARACTERISTICS ⁽³⁾
 $V_{CC} = 3.3V$, $C_F = 0nF$, $C_L = 1nF$, $T_J = -40^{\circ}C$ to $+125^{\circ}C$, unless otherwise noted.

| Parameters | Symbol | Condition | Min | Typ ⁽¹¹⁾ | Max | Units |
|---|---------------|--|------|---------------------|------|-------|
| Optimized accuracy range ⁽⁶⁾ | I_P | | -20 | | +20 | A |
| Sensitivity | SENS | $-20A \leq I_P \leq +20A$, $T_J = 25^{\circ}C$ | | 66 | | mV/A |
| Sensitivity error | E_{SENS} | $I_P = 20A$, $T_J = 25^{\circ}C$ to $125^{\circ}C$ | -2 | | +2 | % |
| | | $I_P = 20A$, $T_J = -40^{\circ}C$ to $+25^{\circ}C$ | | ±1.5 | | % |
| Offset voltage ⁽⁷⁾ | V_{OE} | $I_P = 0A$, $T_J = 25^{\circ}C$ to $125^{\circ}C$ | -10 | | +10 | mV |
| | | $I_P = 0A$, $T_J = -40^{\circ}C$ to $+25^{\circ}C$ | | ±5 | | mV |
| Total output error ⁽⁸⁾ | E_{TOT} | $I_P = 20A$, $T_J = 25^{\circ}C$ to $125^{\circ}C$ | -2.5 | | +2.5 | % |
| | | $I_P = 20A$, $T_J = -40^{\circ}C$ to $+25^{\circ}C$ | | ±1.5 | | % |
| Sensitivity error lifetime drift ⁽¹⁰⁾ | $E_{SENS(D)}$ | | | ±1 | | % |
| Total output error lifetime drift ⁽¹⁰⁾ | $E_{TOT(D)}$ | | | ±1 | | % |

MCS1802-30 PERFORMANCE CHARACTERISTICS ⁽⁴⁾
 $V_{CC} = 3.3V$, $C_F = 0nF$, $C_L = 1nF$, $T_J = -40^{\circ}C$ to $+125^{\circ}C$, unless otherwise noted.

| Parameters | Symbol | Condition | Min | Typ ⁽¹¹⁾ | Max | Units |
|---|---------------|--|------|---------------------|------|-------|
| Optimized accuracy range ⁽⁶⁾ | I_P | | -30 | | +30 | A |
| Sensitivity | SENS | $-30A \leq I_P \leq +30A$, $T_J = 25^{\circ}C$ | | 44 | | mV/A |
| Sensitivity error | E_{SENS} | $I_P = 30A$, $T_J = 25^{\circ}C$ to $125^{\circ}C$ | -2 | | +2 | % |
| | | $I_P = 30A$, $T_J = -40^{\circ}C$ to $+25^{\circ}C$ | | ±1.5 | | % |
| Offset voltage ⁽⁷⁾ | V_{OE} | $I_P = 0A$, $T_J = 25^{\circ}C$ to $125^{\circ}C$ | -10 | | +10 | mV |
| | | $I_P = 0A$, $T_J = -40^{\circ}C$ to $+25^{\circ}C$ | | ±5 | | mV |
| Total output error ⁽⁸⁾ | E_{TOT} | $I_P = 30A$, $T_J = 25^{\circ}C$ to $125^{\circ}C$ | -2.5 | | +2.5 | % |
| | | $I_P = 30A$, $T_J = -40^{\circ}C$ to $+25^{\circ}C$ | | ±1.5 | | % |
| Sensitivity error lifetime drift ⁽¹⁰⁾ | $E_{SENS(D)}$ | | | ±1 | | % |
| Total output error lifetime drift ⁽¹⁰⁾ | $E_{TOT(D)}$ | | | ±1 | | % |

MCS1802-40 PERFORMANCE CHARACTERISTICS ⁽⁴⁾
 $V_{CC} = 3.3V$, $C_F = 0nF$, $C_L = 1nF$, $T_J = -40^{\circ}C$ to $+125^{\circ}C$, unless otherwise noted.

| Parameters | Symbol | Condition | Min | Typ ⁽¹¹⁾ | Max | Units |
|---|---------------|--|------|---------------------|------|-------|
| Optimized accuracy range ⁽⁶⁾ | I_P | | -40 | | +40 | A |
| Sensitivity | SENS | $-40A \leq I_P \leq +40A$, $T_J = 25^{\circ}C$ | | 33 | | mV/A |
| Sensitivity error | E_{SENS} | $I_P = 40A$, $T_J = 25^{\circ}C$ to $125^{\circ}C$ | -2 | | +2 | % |
| | | $I_P = 40A$, $T_J = -40^{\circ}C$ to $+25^{\circ}C$ | | ±1.5 | | % |
| Offset voltage ⁽⁷⁾ | V_{OE} | $I_P = 0A$, $T_J = 25^{\circ}C$ to $125^{\circ}C$ | -10 | | +10 | mV |
| | | $I_P = 0A$, $T_J = -40^{\circ}C$ to $+25^{\circ}C$ | | ±5 | | mV |
| Total output error ⁽⁸⁾ | E_{TOT} | $I_P = 40A$, $T_J = 25^{\circ}C$ to $125^{\circ}C$ | -2.5 | | +2.5 | % |
| | | $I_P = 40A$, $T_J = -40^{\circ}C$ to $+25^{\circ}C$ | | ±1.5 | | % |
| Sensitivity error lifetime drift ⁽¹⁰⁾ | $E_{SENS(D)}$ | | | ±1 | | % |
| Total output error lifetime drift ⁽¹⁰⁾ | $E_{TOT(D)}$ | | | ±1 | | % |

MCS1802-50 PERFORMANCE CHARACTERISTICS ⁽³⁾
 $V_{CC} = 3.3V$, $C_F = 0nF$, $C_L = 1nF$, $T_J = -40^{\circ}C$ to $+125^{\circ}C$, unless otherwise noted.

| Parameters | Symbol | Condition | Min | Typ ⁽¹¹⁾ | Max | Units |
|---|---------------|--|------|---------------------|------|-------|
| Optimized accuracy range ⁽⁶⁾ | I_P | | -50 | | +50 | A |
| Sensitivity | SENS | $-50A \leq I_P \leq +50A$, $T_J = 25^{\circ}C$ | | 26.4 | | mV/A |
| Sensitivity error | E_{SENS} | $I_P = 50A$, $T_J = 25^{\circ}C$ to $125^{\circ}C$ | -2 | | +2 | % |
| | | $I_P = 50A$, $T_J = -40^{\circ}C$ to $+25^{\circ}C$ | | ±1.5 | | % |
| Offset voltage ⁽⁷⁾ | V_{OE} | $I_P = 0A$, $T_J = 25^{\circ}C$ to $125^{\circ}C$ | -10 | | +10 | mV |
| | | $I_P = 0A$, $T_J = -40^{\circ}C$ to $+25^{\circ}C$ | | ±5 | | mV |
| Total output error ⁽⁸⁾ | E_{TOT} | $I_P = 50A$, $T_J = 25^{\circ}C$ to $125^{\circ}C$ | -2.5 | | +2.5 | % |
| | | $I_P = 50A$, $T_J = -40^{\circ}C$ to $+25^{\circ}C$ | | ±1.5 | | % |
| Sensitivity error lifetime drift ⁽¹⁰⁾ | $E_{SENS(D)}$ | | | ±1 | | % |
| Total output error lifetime drift ⁽¹⁰⁾ | $E_{TOT(D)}$ | | | ±1 | | % |

Notes:

- 4) See the Operation section on page 19 for more details.
- 5) Beyond the maximum specified current range (I_P), the current sensor continues to provide an analog output voltage proportional to the primary current until the device reaches the high or low saturation voltage. However, nonlinearity increases when the device operates beyond the specified range (I_P).
- 6) The device can operate at higher primary current levels (I_P) and ambient temperatures (T_A), as long as the device does not exceed the maximum junction temperature (T_J (MAX)).
- 7) The offset voltage does not incorporate any error due to external magnetic fields.
- 8) Percentage of I_P , when $I_P = I_{P_MAX}$. The output filtered.
- 9) Guaranteed by design.
- 10) Guaranteed by characterization.
- 11) Typical values denoted with the "±" sign signify ±3 sigma values.
- 12) The resistance is defined as the total resistance measured from a point of the lead next to the solder joint, assuming that the two I_P+ pins (and I_P- pins) have the same potential (see Figure 1). This definition corresponds to the effective resistance used to estimate the Joule heating, calculated with $R \times I_P^2$.

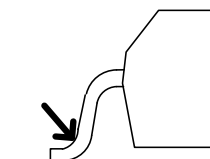
Figure 1: Total Resistance

TYPICAL CHARACTERISTICS

MCS1802GS-50, unless otherwise noted.

Offset Voltage vs. Temperature

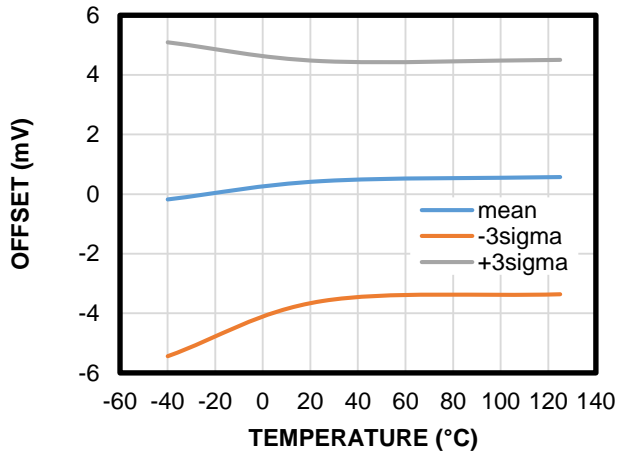

Sensitivity vs. Temperature

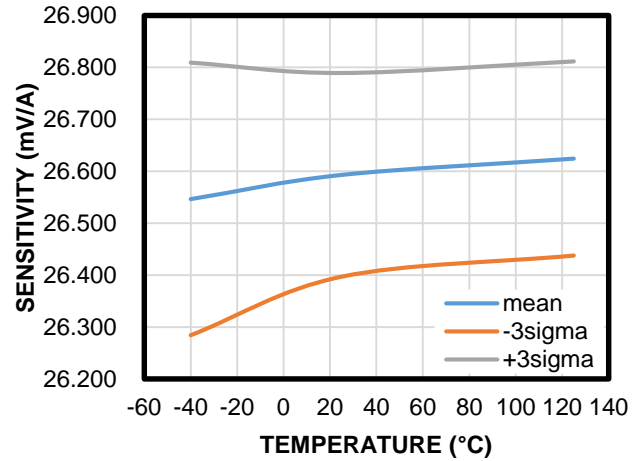

Sensitivity Error vs. Temperature

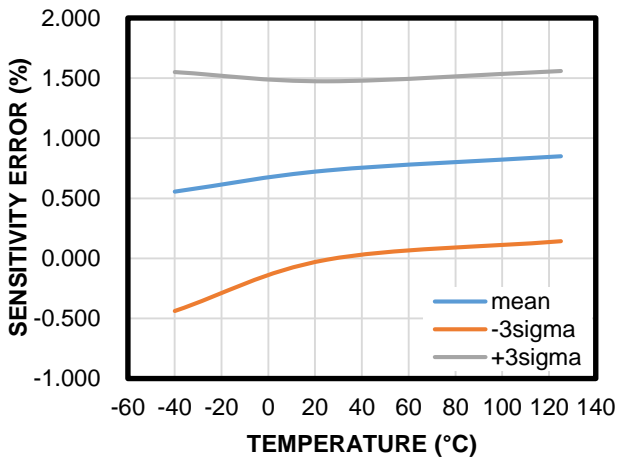

Total Error vs. Temperature

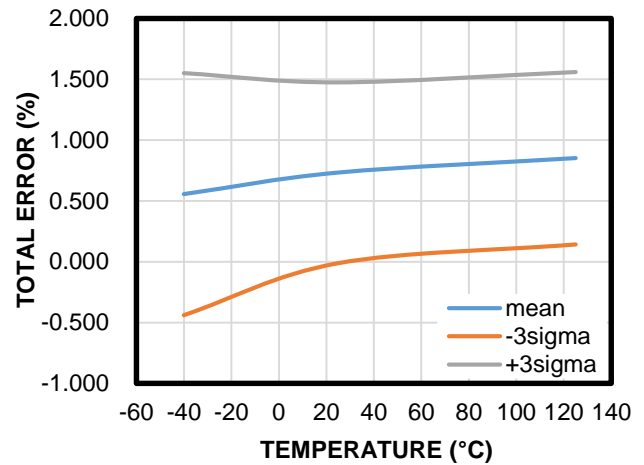

TYPICAL CHARACTERISTICS

MCS1802GS-40, unless otherwise noted.

Offset Voltage vs. Temperature

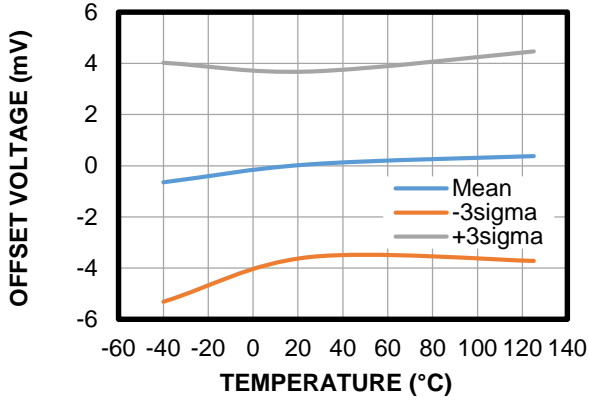

Sensitivity vs. Temperature

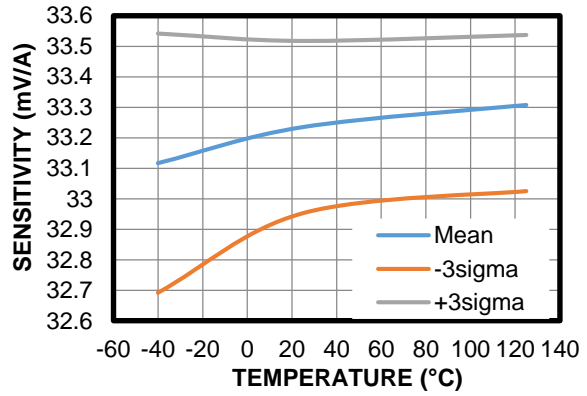

Sensitivity Error vs. Temperature

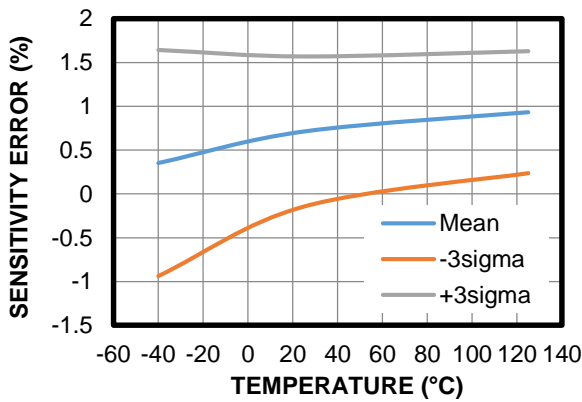

Total Error vs. Temperature

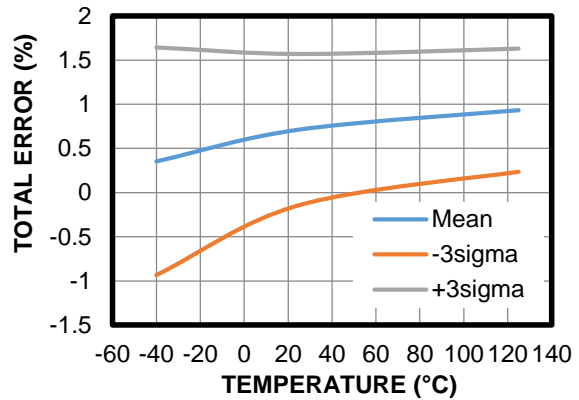

TYPICAL CHARACTERISTICS

MCS1802GS-30, unless otherwise noted.

Offset Voltage vs. Temperature

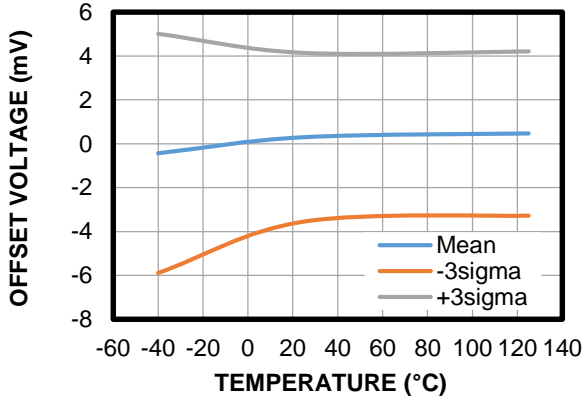

Sensitivity vs. Temperature

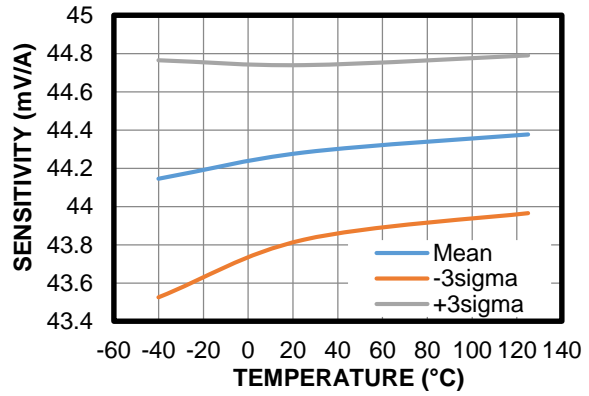

Sensitivity Error vs. Temperature

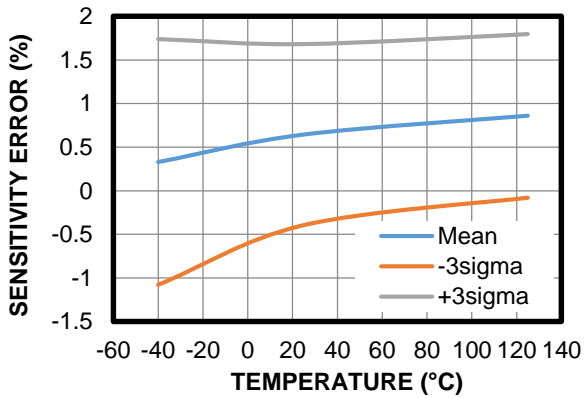

Total Error vs. Temperature

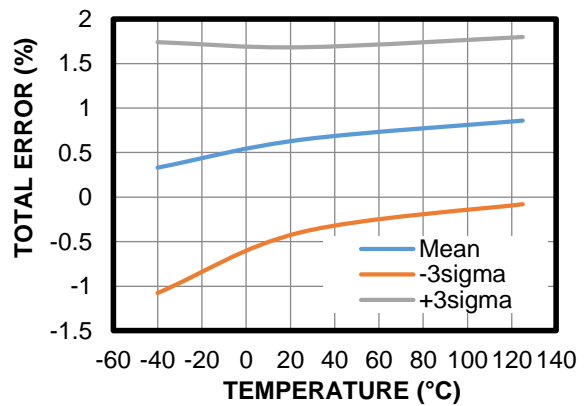

TYPICAL CHARACTERISTICS

MCS1802GS-20, unless otherwise noted.

Offset Voltage vs. Temperature

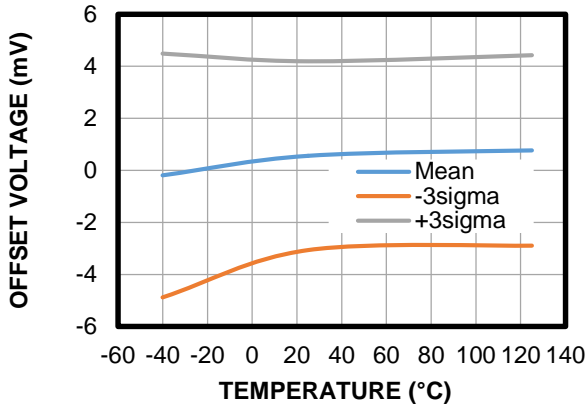

Sensitivity vs. Temperature

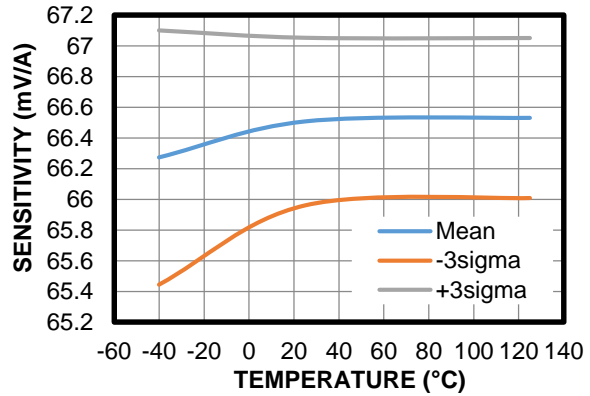

Sensitivity Error vs. Temperature

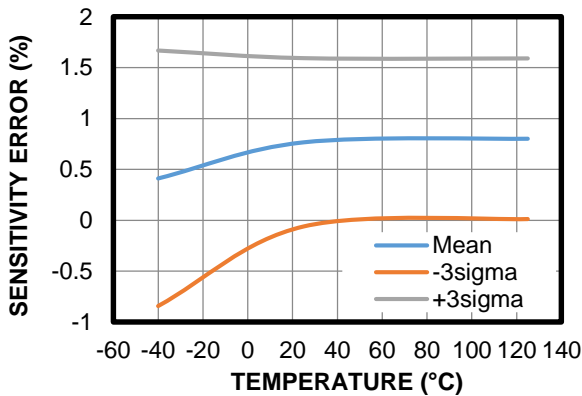

Total Error vs. Temperature

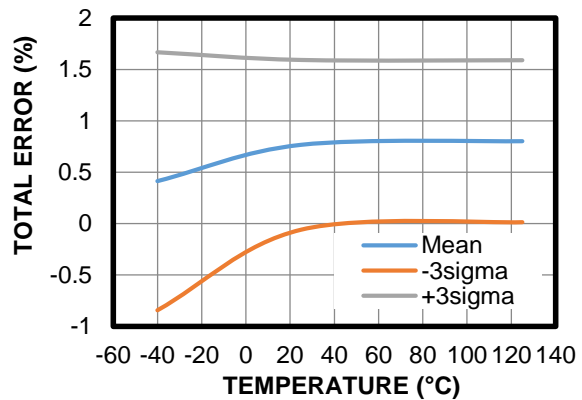

TYPICAL CHARACTERISTICS

MCS1802GS-10, unless otherwise noted.

Offset Voltage vs. Temperature

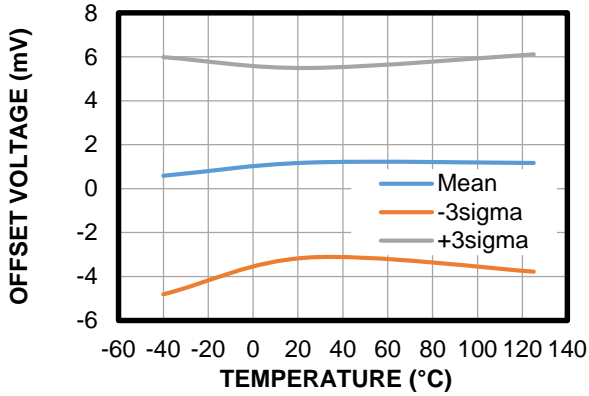

Sensitivity vs. Temperature

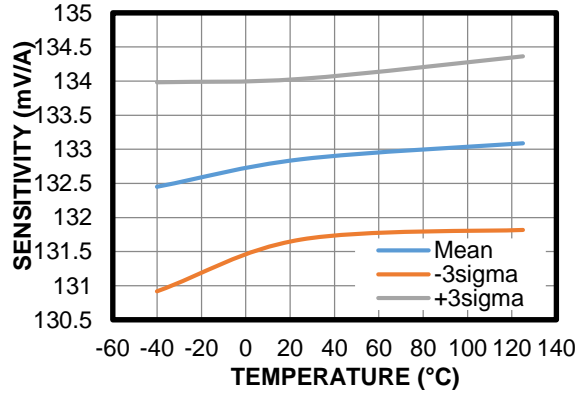

Sensitivity Error vs. Temperature

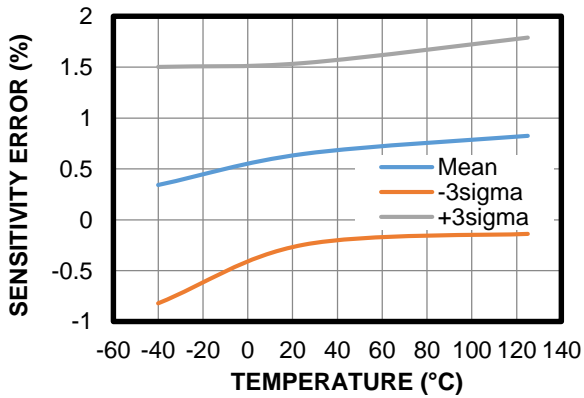

Total Error vs. Temperature

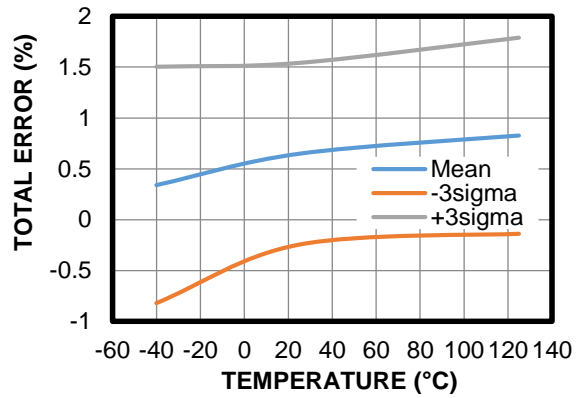

TYPICAL CHARACTERISTICS

MCS1802GS-05, unless otherwise noted.

Offset Voltage vs. Temperature

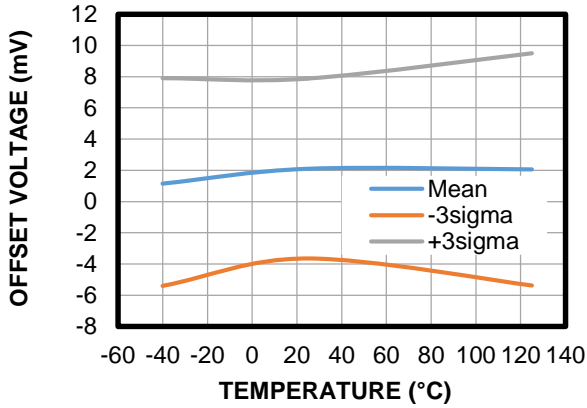

Sensitivity vs. Temperature

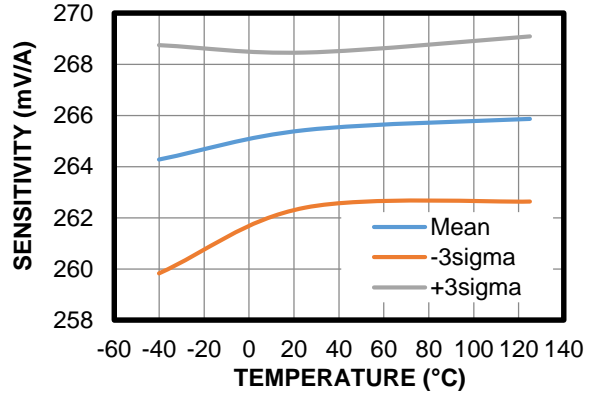

Sensitivity Error vs. Temperature

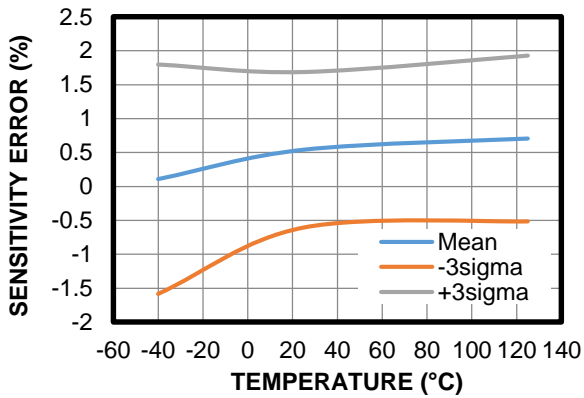

Total Error vs. Temperature

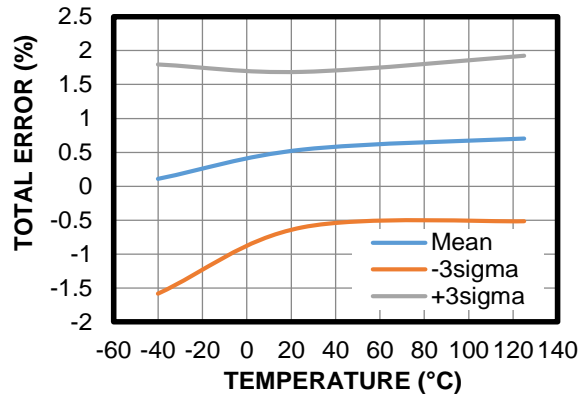

FUNCTIONAL BLOCK DIAGRAM

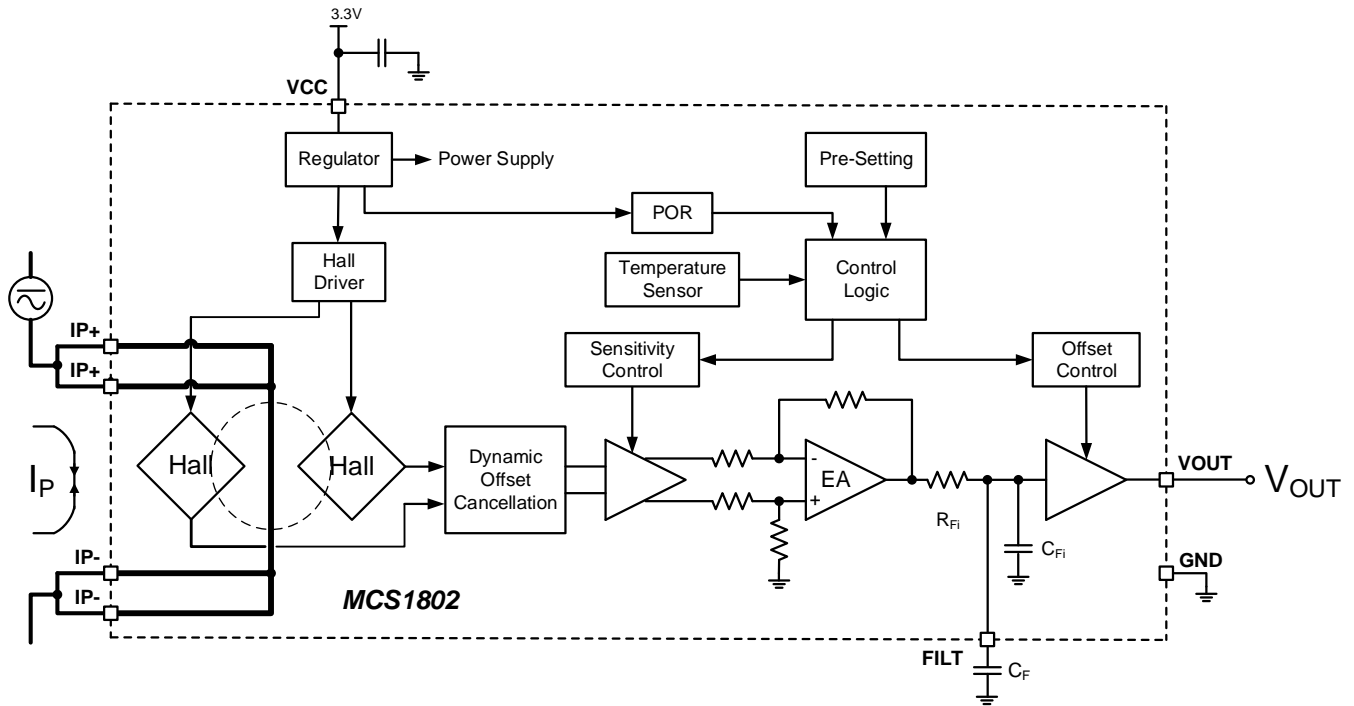

Figure 2: Functional Block Diagram

OPERATION

Current Rating

$I_{P_{MAX}}$ is the rated current. The sensor output is linear, as a function of the primary current (I_P). $I_{P_{MAX}}$ follows the specified performances when I_P is between $-I_{P_{MAX}}$ and $+I_{P_{MAX}}$ (see Figure 3).

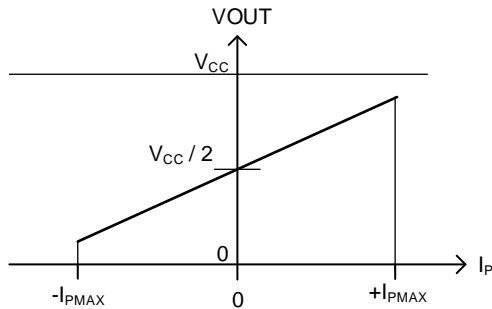

Figure 3 : Sensor Output Function

Sensitivity (SENS)

The sensitivity (SENS) (in mV/A) indicates how the output changes when the primary current changes. SENS is the product of the average between the two coupling constants (P_{MCF1} and P_{MCF2}) (in mT/A) and the transducer gain (in mV/mT). The gain is factory-trimmed to the sensor target sensitivity.

Coupling Constants (P_{MCF1} and P_{MCF2})

Figure 4 shows a cross-section of the sensor. The first and second Hall magnetic coupling factors are defined as the amount of the vertical magnetic field (B_1 and B_2) produced at the sensing points 1 and 2, per unit of current injected in the primary conductor. Due to the asymmetrical shape of the primary conductor, the magnetic field generated at the two sensing points are different.

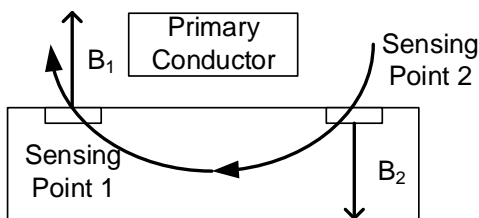

Figure 4: Cross Section of the Sensor

Noise (V_{NOISE})

The noise (V_{NOISE}) is a random deviation that cannot be removed by calibrating the device. The input's referred noise is the root mean square of the sensor's output noise (in mV)

divided by the sensitivity (in mV/A). V_{NOISE} represents the smallest current that the device is able to resolve without any external signal treatment (the resolution is typically 3 times the RMS noise).

Other deviations are systematic, which means that they represent the average deviation across a large number of data points. These deviations can be removed by calibrating the device.

Zero Current Output Voltage ($V_{OUT(Q)}$)

$V_{OUT(Q)}$ is the voltage output when the primary current is 0A. The nominal value is $V_{CC} / 2$. The variation in $V_{OUT(Q)}$ from the nominal value is due to thermal drift, as well as the factory's resolution limits related to voltage offset trimming.

Offset Voltage (V_{OE})

The offset voltage (V_{OE}) is the difference between $V_{CC} / 2$ and the zero current output voltage. To convert this voltage into amperes, divide V_{OE} by the sensitivity.

Nonlinearity (E_{LIN})

The primary current and sensor output should have a linear relationship, indicated by a straight line. A line that is not straight indicates nonlinearity, which is a deviation.

Nonlinearity (in %) can be calculated with Equation (1):

$$E_{LIN} = \frac{\text{Max}(V_{OUT}(I_P) - V_{LIN}(I_P))}{V_{OUT}(I_{P_{MAX}}) - V_{OUT}(-I_{P_{MAX}})} \times 100 \quad (1)$$

Where $V_{LIN}(I_P)$ is the approximate straight line calculated by the least square method. Note that depending on the curvature of $V_{OUT}(I_P)$, E_{LIN} can be positive or negative.

Total Output Error (E_{TOT})

E_{TOT} (in %) is the relative difference between the sensor output and the ideal output at a given primary current (I_P). E_{TOT} can be estimated with Equation (2):

$$E_{TOT}(I_P) = \frac{V_{OUT}(I_P) - V_{OUT_IDEAL}(I_P)}{SENS \times I_P} \times 100 \quad (2)$$

Where V_{OUT_IDEAL} can be calculated with Equation (3):

$$V_{OUT_IDEAL}(I_P) = \frac{VCC}{2} + SENS \times I_P \quad (3)$$

The total output error incorporates all error sources, and is a function of I_P . At currents close to I_{P_MAX} , E_{TOT} is affected mainly by the sensitivity error. At currents close to 0A, E_{TOT} is mostly caused by the offset voltage (V_{OE}). Note that when $I_P = 0A$, E_{TOT} diverges to infinity due to the constant offset.

Ratiometry Coefficients

Generally, the sensor output is ratiometric. This means that the sensitivity and the zero current output scale with VDD . The ratiometry coefficients measure if the sensitivity and zero output current are proportional.

K_{SENS} can be estimated with Equation (4):

$$K_{SENS} = \frac{SENS(VCC)/SENS(5V)}{VCC/5V} \quad (4)$$

K_{VO} can be calculated with Equation (5):

$$K_{VO} = \frac{V_{OUT}(I_P = 0V \text{ to } VCC) / V_{OUT}(I_P = 0V \text{ to } 5V)}{VCC/5V} \quad (5)$$

It is recommended for K_{SENS} and K_{VO} to be equal to 1.

Power On Time (t_{PO})

The power on time (t_{PO}) is the time interval after power is first applied to the device, until the output can correctly indicate the applied primary current. t_{PO} is defined as the time between the following moments:

1. t_1 : The supply reaches the minimum operating voltage (VCC_{MIN}).
2. t_2 : V_{OUT} settles within ±10% of its steady state value under an applied primary current (see Figure 5).

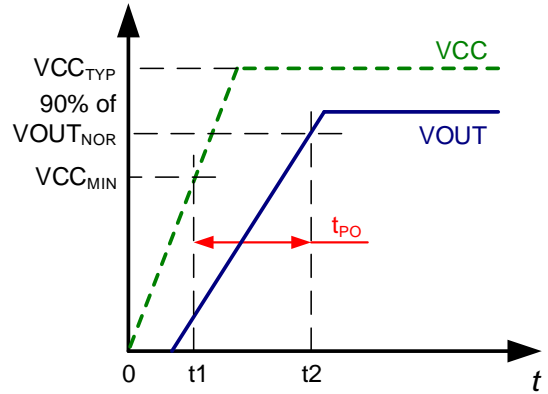

Figure 5: Power On Time (t_{PO})

Propagation Delay (t_{PD})

The propagation delay (t_{PD}) represents the internal latency between an event that has been measured and the sensor's response. t_{PD} is defined as the time between the following moments:

1. t_1 : The primary current signal reaches 20% of I_{P_MAX} .
2. t_2 : V_{OUT} reaches 20% of V_{OUT_MAX} (see Figure 6).

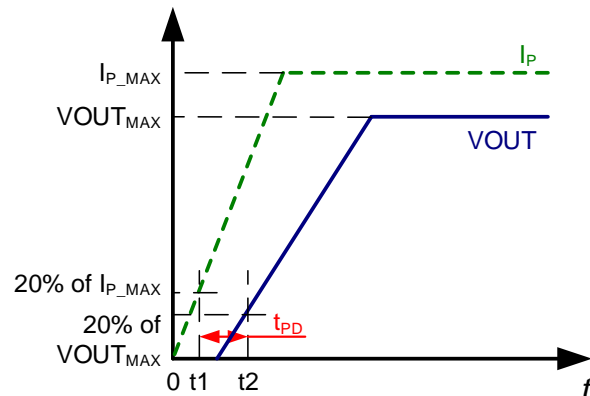

Figure 6: Propagation Delay (t_{PD})

Rising Time (t_R)

The rising time (t_R) is defined as the time between the following moments:

1. t_1 : The sensor's V_{OUT} reaches 10% of its full scale value.
2. t_2 : The sensor's V_{OUT} reaches 90% of its full scale value (see).

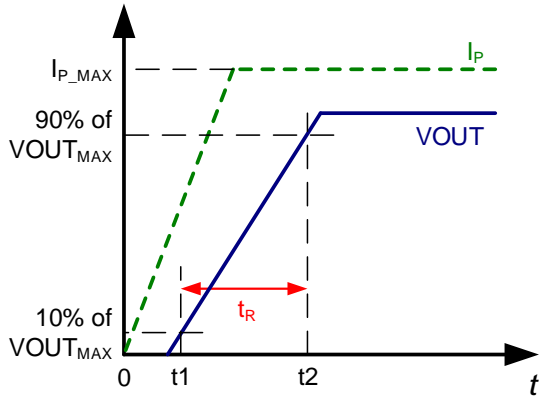

Figure 7: Rising Time (t_R)

The sensor bandwidth (f_{BW}) is defined as the 3dB cutoff frequency.

By using the rising time, f_{BW} can be estimated with Equation (6):

$$f_{BW} = 0.35 / t_R \quad (6)$$

Response Time ($t_{RESPONSE}$)

The response time ($t_{RESPONSE}$) is defined as the time between the following moments:

1. t_1 : The primary current signal reaches 90% of its final value.
2. t_2 : V_{OUT} reaches 90% of its output, as it corresponds to the applied primary current (see Figure 8).

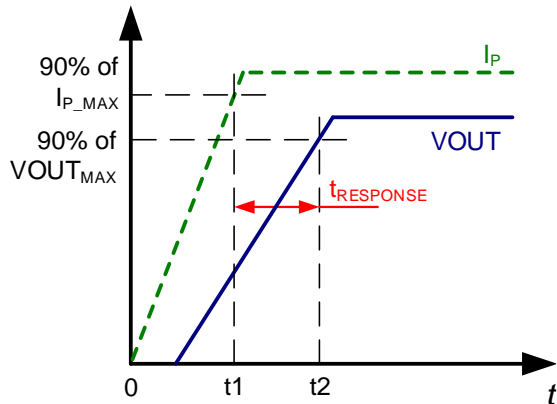

Figure 8: Response Time ($t_{RESPONSE}$)

Remove the ground and power planes under the IC to reduce the effect of eddy currents on t_R and $t_{RESPONSE}$.

Adjustable Bandwidth

The sensor dynamic can be adjusted with an external capacitor (C_F). In this scenario, the bandwidth (f_{BW}) can be calculated with Equation (7):

$$f_{BW} = \frac{1}{2\pi} \times \frac{1}{R_{Fi} \times (C_{Fi} + C_F)} \quad (7)$$

Figure 9 shows the typical bandwidth curve.

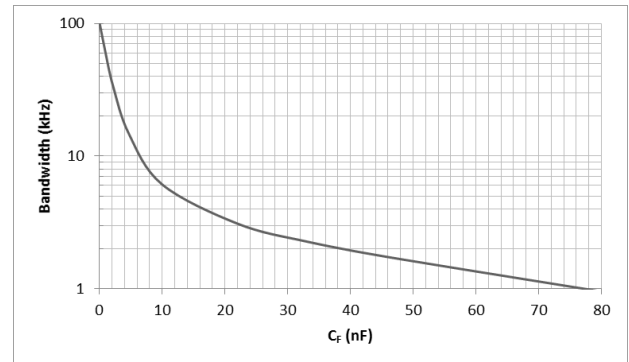

Figure 9: Bandwidth vs. C_F

APPLICATION INFORMATION

Self-Heating Performance

The conductor and MCS1802 temperatures can rise when current flows through the primary conductor. This means that self-heating should be carefully verified to ensure that the IC junction temperature does not exceed the maximum value (see the Absolute Maximum Ratings on page 6).

The thermal behavior strongly depends on the thermal environment of the IC, as well as its cooling capacity. In particular, thermal behavior depends on the PCB copper area's thickness. The thermal response is also related to the current waveform's profile (e.g. the amplitude and frequency of an AC current, or the peaks and duty cycle of a pulsed DC current).

Figure 10 shows the self-heating performance of the MCS1802 with a DC current input. The data is collected when the MCS1802 is mounted on the device's evaluation board and $T_A = 25^\circ\text{C}$. Values were taken 10 minutes after a continuous current.

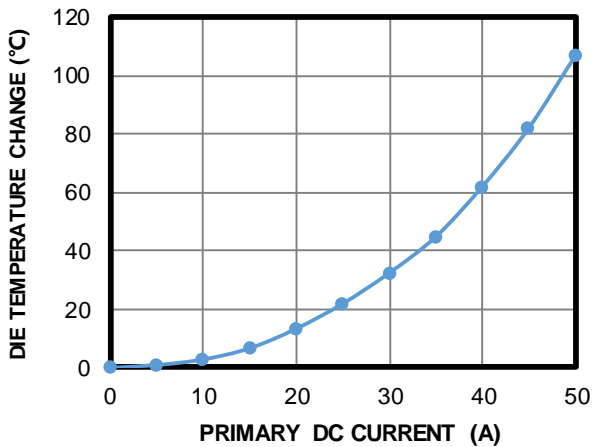
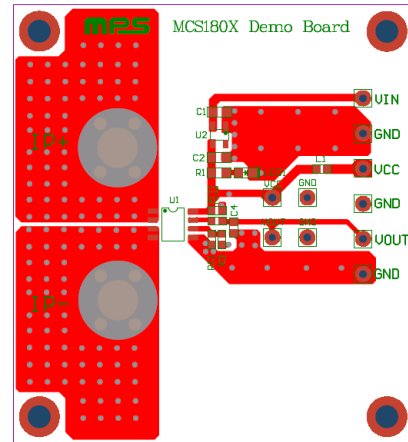
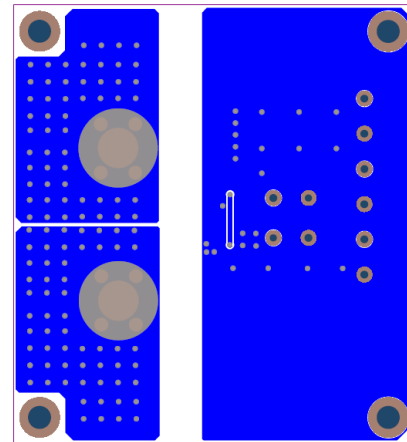

Figure 10: Self-Heating Performance with a DC Current Input

Figure 11 shows the top and bottom layers of the PCB. The board includes a total of 2200mm², 4oz (139μm) copper connected to the primary conductor by the IP+ and IP- pins. The copper covers both the top and bottom sides, and thermal vias connect the two layers.



Top Layer



Bottom Layer

Figure 11: Recommended PCB Layout

TYPICAL APPLICATION CIRCUIT

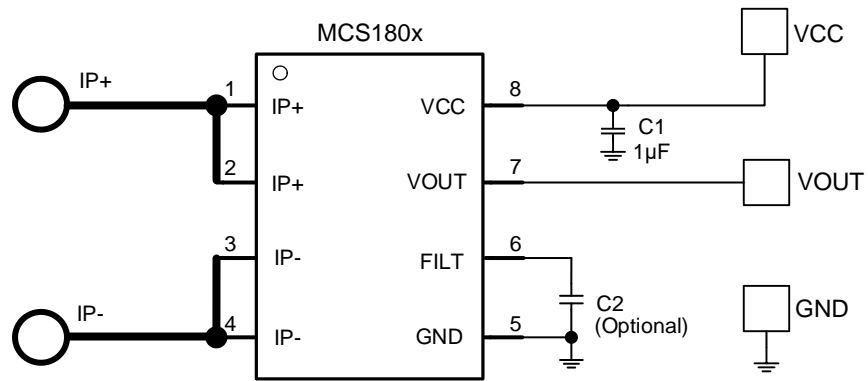
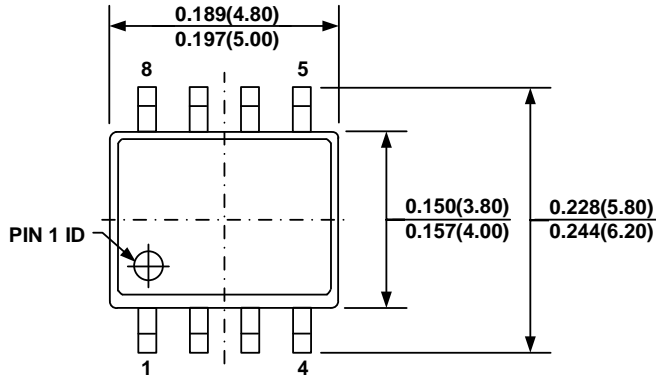

Figure 12: Typical Application Circuit

PACKAGE INFORMATION

SOIC-8



TOP VIEW

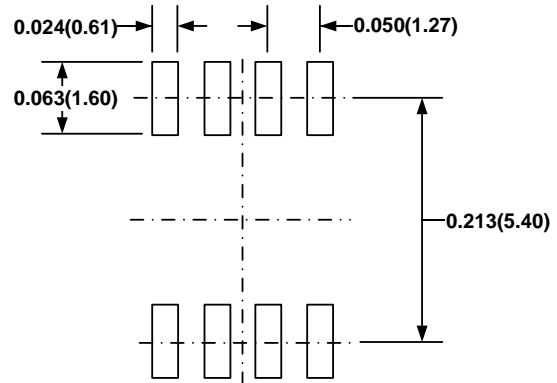

RECOMMENDED LAND PATTERN

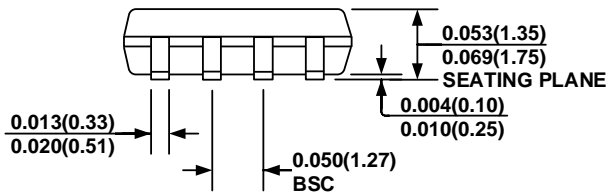

FRONT VIEW

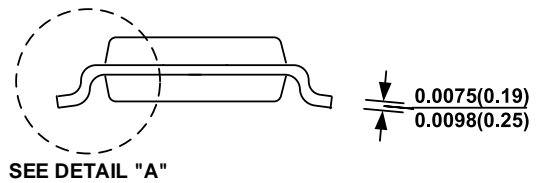

SIDE VIEW

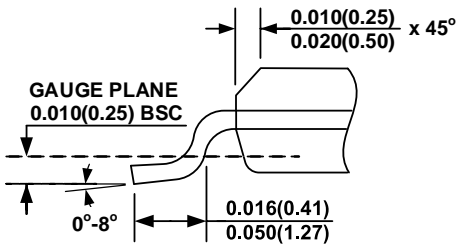

DETAIL "A"

NOTE:

- 1) CONTROL DIMENSION IS IN INCHES. DIMENSION IN BRACKET IS IN MILLIMETERS.
- 2) PACKAGE LENGTH DOES NOT INCLUDE MOLD FLASH, PROTRUSION, OR GATE BURR.
- 3) PACKAGE WIDTH DOES NOT INCLUDE INTERLEAD FLASH OR PROTRUSIONS.
- 4) LEAD COPLANARITY (BOTTOM OF LEADS AFTER FORMING) SHALL BE 0.004" INCHES MAX.
- 5) DRAWING CONFORMS TO JEDEC MS-012, VARIATION AA.
- 6) DRAWING IS NOT TO SCALE.

CARRIER INFORMATION

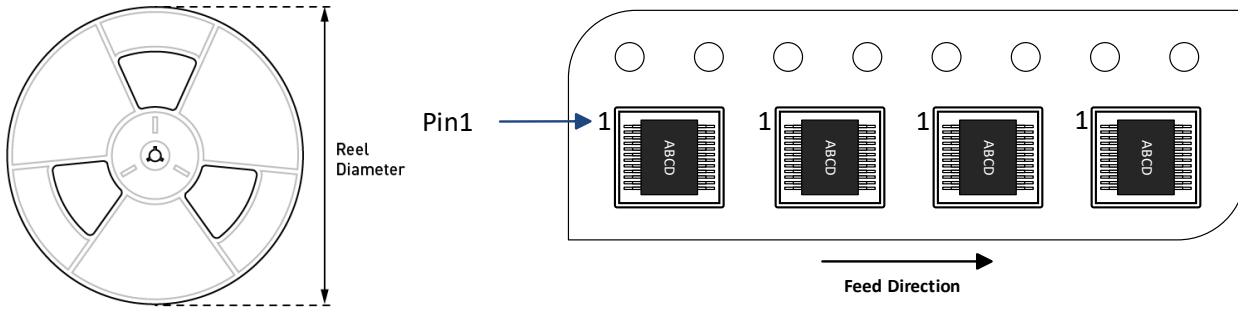

| Part Number | Package Description | Quantity/ Reel | Quantity/ Tube | Quantity/ Tray | Reel Diameter | Carrier Tape Width | Carrier Tape Pitch |
|----------------|---------------------|----------------|----------------|----------------|---------------|--------------------|--------------------|
| MCS1802GS-05-Z | SOIC-8 | 2500 | N/A | N/A | 13in | 12mm | 8mm |
| MCS1802GS-10-Z | SOIC-8 | 2500 | N/A | N/A | 13in | 12mm | 8mm |
| MCS1802GS-20-Z | SOIC-8 | 2500 | N/A | N/A | 13in | 12mm | 8mm |
| MCS1802GS-30-Z | SOIC-8 | 2500 | N/A | N/A | 13in | 12mm | 8mm |
| MCS1802GS-40-Z | SOIC-8 | 2500 | N/A | N/A | 13in | 12mm | 8mm |
| MCS1802GS-50-Z | SOIC-8 | 2500 | N/A | N/A | 13in | 12mm | 8mm |

REVISION HISTORY

| Revision # | Revision Date | Description | Pages Updated |
|------------|---------------|-----------------|---------------|
| 1.0 | 4/14/2021 | Initial Release | - |

Notice: The information in this document is subject to change without notice. Please contact MPS for current specifications. Users should warrant and guarantee that third-party Intellectual Property rights are not infringed upon when integrating MPS products into any application. MPS will not assume any legal responsibility for any said applications.