



























4 Female Connectors with CAGE CLAMP®, 100 % Protected against Mismatching, Pin Spacing 5 mm / 0.197 in, Light Grey

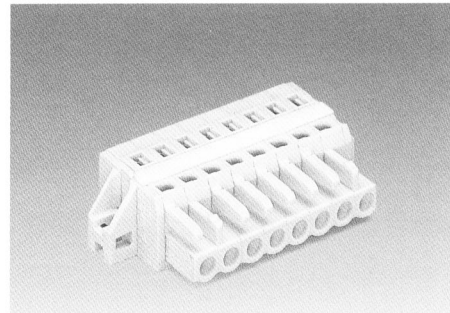
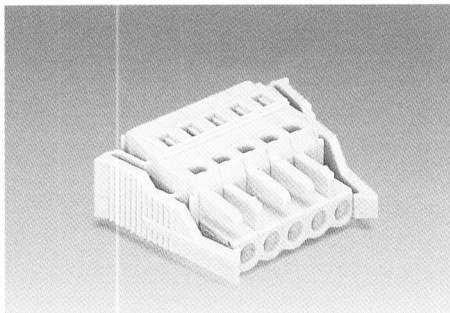
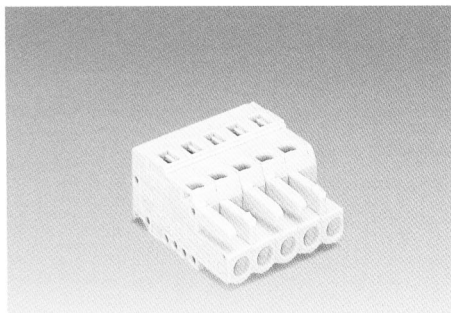







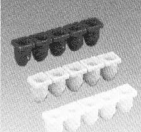

44

<p>Pin spacing 5 mm/0.197 in, light grey 0.08 – 2.5 mm² AWG 28 – 12 250 V/4 kV/3 300 V, 15 A  16 A 300 V, 15 A </p> <p> 8 – 9 mm / 0.33 in</p> <p>*    </p>	<p>Pin spacing 5 mm/0.197 in, light grey 0.08 – 2.5 mm² AWG 28 – 12 250 V/4 kV/3 300 V, 15 A  16 A 300 V, 15 A </p> <p> 8 – 9 mm / 0.33 in</p> <p>*    </p>	<p>Pin spacing 5 mm/0.197 in, light grey 0.08 – 2.5 mm² AWG 28 – 12 250 V/4 kV/3 300 V, 15 A  16 A 300 V, 15 A </p> <p> 8 – 9 mm / 0.33 in</p> <p>*    </p>
---	---	---

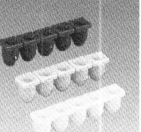

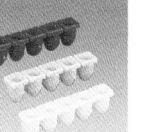
No. of poles	Item-No.	No. of poles	Item-No.	No. of poles	Item-No.	
Female connectors with CAGE CLAMP®, 100 % protected against mismatching, with coding fingers, with two latches, light grey		Female connectors with CAGE CLAMP® and locking device, 100 % protected against mismatching, with coding fingers, with two latches, light grey		Female connectors with CAGE CLAMP® and fixing langes, for racks and feedthrough connections, 100 % protected against mismatching, with reinforcing strips, with coding fingers, with two latches, for screw or similar methods of fixing, light grey		
2 (one latch only)	721-102/026-000	2 (one latch only)	721-102/037-000	2	please use the female connectors for panel mounting (item.-No. 721-102/031-000 to 721-105/031-000) see page 4.45	
3	721-103/026-000 	3	721-103/037-000 	3		
4	721-104/026-000 	4	721-104/037-000 	4		
5	721-105/026-000 	5	721-105/037-000 	5		
6	721-106/026-000	6	721-106/037-000	6		721-106/027-000
:	:	:	:	:		:
10	721-110/026-000	10	721-110/037-000	10	721-110/027-000	
12	721-112/026-000	12	721-112/037-000	12	721-112/027-000	
14	721-114/026-000	14	721-114/037-000	14	721-114/027-000	
16	721-116/026-000	16	721-116/037-000	16	721-116/027-000	
20	721-120/026-000	20	721-120/037-000	20	721-120/027-000	

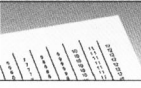
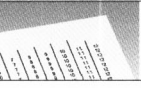
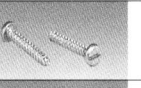
Accessories

	Test plug , w. cable 500 mm/1'7.7" 2 mm/0.079 in Ø, red 210-136 2.3 mm/0.091 in Ø, yel. 210-137		Test plug , w. cable 500 mm/1'7.7" 2 mm/0.079 in Ø, red 210-136 2.3 mm/0.091 in Ø, yel. 210-137		Test plug , w. cable 500 mm/1'7.7" 2 mm/0.079 in Ø, red 210-136 2.3 mm/0.091 in Ø, yel. 210-137
	Insulation stop , 5 pcs/strip 0.08 - 0.2 mm ²  (white) 231-670 0.25 - 0.5 mm ² (light gr.) 231-671 0.75 - 1 mm ² (dark grey) 231-672		Insulation stop , 5 pcs/strip 0.08 - 0.2 mm ²  (white) 231-670 0.25 - 0.5 mm ² (light gr.) 231-671 0.75 - 1 mm ² (dark grey) 231-672		Insulation stop , 5 pcs/strip 0.08 - 0.2 mm ²  (white) 231-670 0.25 - 0.5 mm ² (light gr.) 231-671 0.75 - 1 mm ² (dark grey) 231-672
	Marker strips , self-adhesive 1-12 (40 x) 249-150/210-218 13-24 (40 x) 249-150/210-219		Marker strips , self-adhesive 1-12 (40 x) 249-150/210-218 13-24 (40 x) 249-150/210-219		Tapping screw , B 2.2 x 9.5 209-147 fixing hole Ø 1.8 mm
					Marker strips , self-adhesive 1-12 (40 x) 249-150/210-218 13-24 (40 x) 249-150/210-219

Dimensions (in mm) L₁ = (No. of poles x pin spacing) + 3 mm L₂ = (No. of poles x pin spacing) + 8.8 mm L₃ = (No. of poles x pin spacing) + 14.8 mm

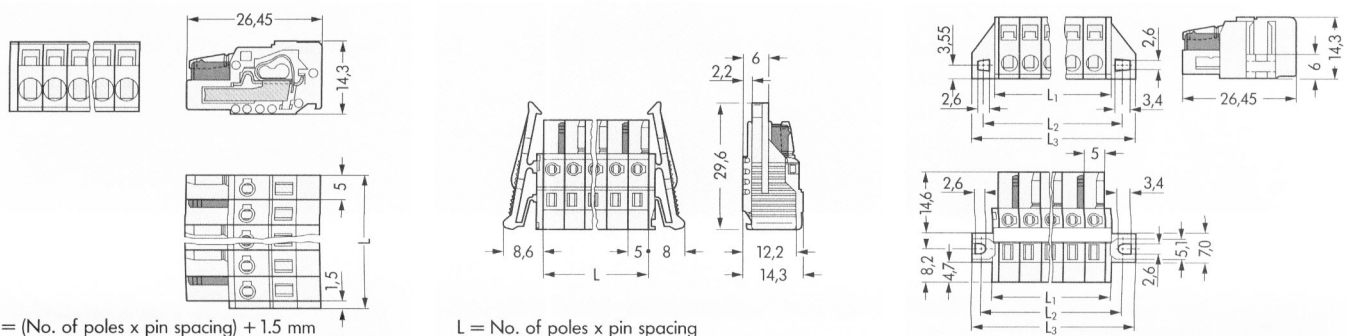

* For further approvals with corresponding ratings see pages 10.3 ff.

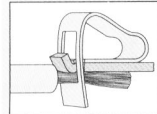

<p>Pin spacing 5 mm/0.197 in, light grey 0.08 – 2.5 mm² AWG 28 – 12 250 V/4 kV/3 300 V, 15 A </p> <p> 8 – 9 mm / 0.33 in</p>	<p>Pin spacing 5 mm/0.197 in, light grey 0.08 – 2.5 mm² AWG 28 – 12 250 V/4 kV/3 300 V, 15 A </p> <p> 8 – 9 mm / 0.33 in</p>	<p>Direct printing</p>
---	--	-------------------------------

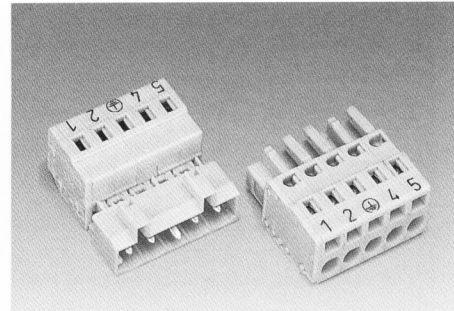
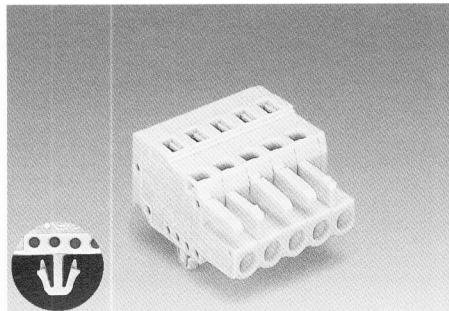
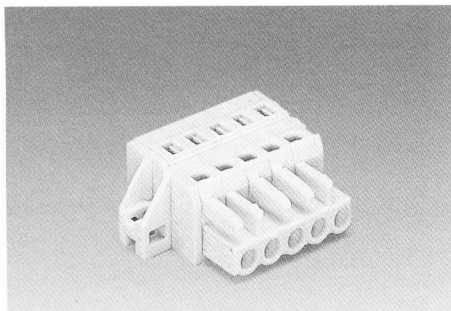

No. of poles	Item-No.	No. of poles	Item-No.
<p>Female connectors with CAGE CLAMP® and fixing flanges, for panel mounting, 100% protected against mismatching, with coding fingers, with two latches, for screw or similar methods of fixing, light grey</p>		<p>Female connectors with CAGE CLAMP® and snap-in mounting feet, 100% protected against mismatching, with coding fingers, with two latches, light grey, for plate thickness 0.6 mm–1.2 mm, fixing hole Ø 3.5 mm (or with mounting adapter 209-137 for DIN 35 rail)</p>	
2 (one latch only)	721-102/031-000	2 (one latch only)	721-102/008-000
3	721-103/031-000 ①	3	721-103/008-000 ①
4	721-104/031-000 ①	4	721-104/008-000 ①
5	721-105/031-000 ①	5	721-105/008-000 ①
6	721-106/031-000	6	721-106/008-000
:	:	:	:
10	721-110/031-000	10	721-110/008-000
12	721-112/031-000	12	721-112/008-000
14	721-114/031-000	14	721-114/008-000
16	721-116/031-000	16	721-116/008-000
20	721-120/031-000	20	721-120/008-000

① 3- to 5-pole female connectors with CAGE CLAMP® are available with special printing, suitable for headers and male connectors with preceding ground (earth) contact.
 Printing 3-pole: 1-⊕-3
 4-pole: 1-2-⊕-4
 5-pole: 1-2-⊕-4-5
 Add. item-No.: .../...-045

Ordering example:
 5-pole female connector with locking device, without printing: 721-105/037-000
 5-pole female connector with locking device, with printing 1-2-⊕-4-5:
 721-105/037-045

Other printings – contact factory

<p>Test plug, w. cable 500 mm/1'7.7" 2 mm/0.079 in Ø, red 210-136 2.3 mm/0.091 in Ø, yel. 210-137</p>	<p>Test plug, w. cable 500 mm/1'7.7" 2 mm/0.079 in Ø, red 210-136 2.3 mm/0.091 in Ø, yel. 210-137</p>	<p>All female connectors with CAGE CLAMP® are also available with printed pole marking. Standard printing: 1-2-3-4-5-... Add. item-No.: .../...-047</p>
<p>Insulation stop, 5 pcs/strip 0.08-0.2 mm² ② (white) 231-670 0.25-0.5 mm² (light gr.) 231-671 0.75-1 mm² (dark grey) 231-672</p> <p>② 0.2 mm² solid/0.14 mm² f-st</p>	<p>Insulation stop, 5 pcs/strip 0.08-0.2 mm² ② (white) 231-670 0.25-0.5 mm² (light gr.) 231-671 0.75-1 mm² (dark grey) 231-672</p> <p>② 0.2 mm² solid/0.14 mm² f-st</p>	
<p>Tapping screw, B 2.2 x 9.5 209-147 fixing hole Ø 1.8 mm</p>	<p>Mounting adapter, for DIN 35 rail, grey 209-137 3 or more poles</p>	<p>Ordering example: 3-pole female connector, without printing: 721-103/026-000 3-pole female connector, with printing 1-2-3: 721-103/026-047</p> <p>Other printings – contact factory</p>
<p>Marker strips, self-adhesive 1-12 (40 x) 249-150/210-218 13-24 (40 x) 249-150/210-219</p>	<p>Marker strips, self-adhesive 1-12 (40 x) 249-150/210-218 13-24 (40 x) 249-150/210-219</p>	

