

## ■ DESCRIPTION

The XC6206 series are precise, low power consumption, high voltage; positive voltage regulators manufactured using CMOS and laser trimming technologies. The series provides large currents with a significantly small dropout voltage. The XC6206 consists of a current limiter circuit, a driver transistor, a precision reference voltage and an error correction circuit. The series is compatible with low ESR ceramic capacitors. The current limiter's foldback circuit also operates as a short protect for the output current limiter and the output pin. Output voltage can be set internally by laser trimming technologies. It is selectable in 100mV increments within a range of 1.2V to 5.0V. SOT-89-3, SOT-23-3, SOT353 and SOT23-3B packages are available.

## ■ FEATURES

- Output Voltage Range                    1.2V to 5.0V (selectable in 100mV steps)
- Highly Accurate                             $\pm 2\%$
- Dropout Voltage                            160mV @ 50mA (3.0V type)
- Low Power Consumption                  $2\ \mu\text{A}$  (TYP.)
- Maximum Output Current                100mA ( $V_{in} \geq V_{out} + 1V$ )
- Internal protector                         current limiter and short protector
- Small packages                            SOT-89-3, SOT-23-3, SOT23-3B, SOT353 and other required

## ■ APPLICATIONS

- Battery powered equipment
- Reference voltage sources
- Cameras, Video cameras
- Mobile phones
- Communication tools

## ■ PACKAGE

- SOT-89-3
- SOT-23-3, SOT23-3B
- SOT353
- Other required

## ■ BLOCK DIAGRAM

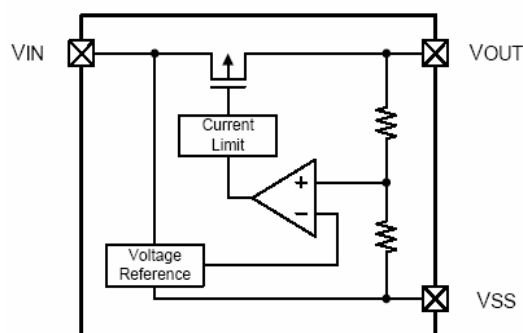

Figure 1

## ■ ABSOLUTE MAXIMUM RATINGS

PARAMETER	SYMBOL	MAXIMUM RATING		UNIT
Input Voltage	$V_{IN}$	$V_{SS}-0.3 \sim V_{SS}+6$		V
Output Current	$V_{OUT}$	$V_{SS}-0.3 \sim V_{IN}+0.3$		
Power Dissipation	$P_D$	SOT-23-3, SOT23-3B	250	mW
		SOT353	250	
		SOT-89-3	500	
Operating Ambient Temperature	$T_{opr}$	-40 ~ +85		°C
Storage Temperature	$T_{stg}$	-40 ~ +125		

**Caution:** The absolute maximum ratings are rated values exceeding which the product could suffer physical damage. These values must therefore not be exceeded under any conditions.

## ■ Electrical Characteristics

Item	Symbol	Condition	MIN	TYP	MAX	UNIT	CIRCUIT	
Output Voltage	$V_{OUT(E)1}$	$V_{IN} = V_{OUT(S)} + 1.0 \text{ V}$ , $I_{OUT} = 1 \text{ mA}$	$V_{OUT(S)} \times 0.98$	$V_{OUT(S)}$	$V_{OUT(S)} \times 1.02$	V	1	
Output Current	$I_{OUT}$	$V_{IN} \geq V_{OUT(S)} + 1.0 \text{ V}$	100	—	—	mA	1	
Dropout Voltage	$V_{drop}$	$I_{OUT} = 50 \text{ mA}$	$1.5 \text{ V} \leq V_{OUT(S)} \leq 2.5 \text{ V}$	—	0.20	0.28	V	1
			$2.6 \text{ V} \leq V_{OUT(S)} \leq 3.3 \text{ V}$	—	0.16	0.24		
			$3.4 \text{ V} \leq V_{OUT(S)} \leq 5.0 \text{ V}$	—	0.12	0.20		
Line Regulations	$\frac{\Delta V_{OUT1}}{\Delta V_{IN} \cdot V_{OUT}}$	$V_{OUT(S)} + 0.5 \text{ V} \leq V_{IN} \leq 5.5 \text{ V}$ $I_{OUT} = 1 \text{ mA}$	—	0.05	0.3	%/V	1	
Input Voltage	$\Delta V_{OUT2}$	$V_{IN} = V_{OUT(S)} + 1.0 \text{ V}$ $1.0 \text{ mA} \leq I_{OUT} \leq 50 \text{ mA}$	—	20	40	mV	1	
Output Voltage Temperature Characteristics	$\frac{\Delta V_{OUT}}{\Delta T_a \cdot V_{OUT}}$	$V_{IN} = V_{OUT(S)} + 1.0 \text{ V}$ , $I_{OUT} = 10 \text{ mA}$ $-40^\circ\text{C} \leq T_a \leq 85^\circ\text{C}$	—	$\pm 100$	—	ppm/°C	1	
Supply Current	$I_{SS1}$	$V_{IN} = V_{OUT(S)} + 1.0 \text{ V}$	—	2	—	$\mu\text{A}$	2	
Input Voltage	$V_{IN}$	—	1.8	—	6	V	—	
Ripple-Rejection	RR	$V_{IN} = V_{OUT(S)} + 1.0 \text{ V}$ , $f = 1.0 \text{ kHz}$ $V_{rip} = 0.5 \text{ V}_{rms}$ , $I_{OUT} = 10 \text{ mA}$	—	40	—	dB	1	
Short current	$I_{short}$	$V_{IN} = V_{OUT(S)} + 1.5 \text{ V}$ ,	—	30	—	mA	1	
Current Limiter	$I_{lim}$	$V_{IN} = V_{OUT(S)} + 1.5 \text{ V}$ ,	—	380	—	mA	1	

■ TEST CIRCUITS

Circuit ①

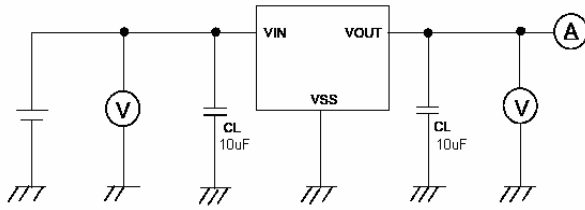

Circuit ②

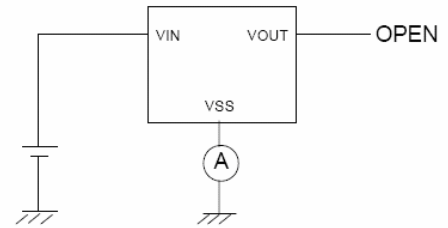

■ TYPICAL APPLICATION CIRCUIT

1、Basic circuit

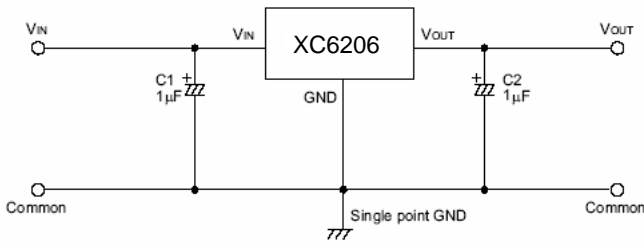

2、High output current positive voltage regulator

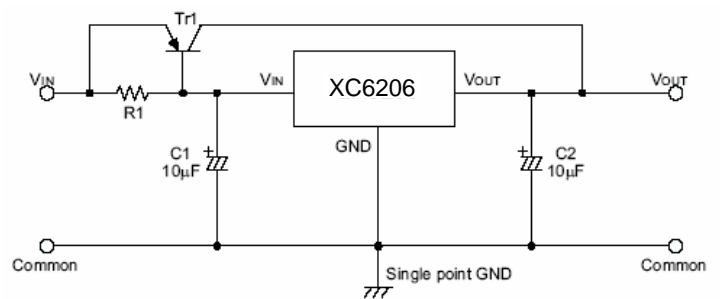

3、Circuit for increasing output voltage

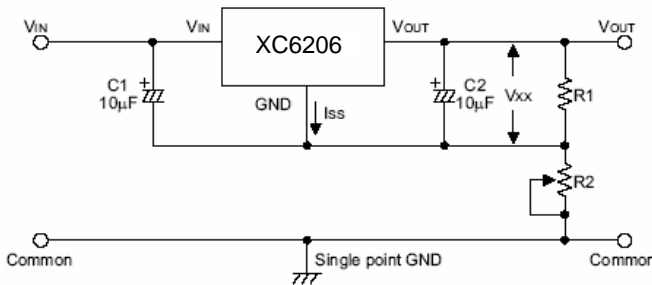

$$V_{OUT} = V_{XX} \left( 1 + \frac{R_2}{R_1} \right) + I_{SS} R_2$$

4、Circuit for increasing output voltage

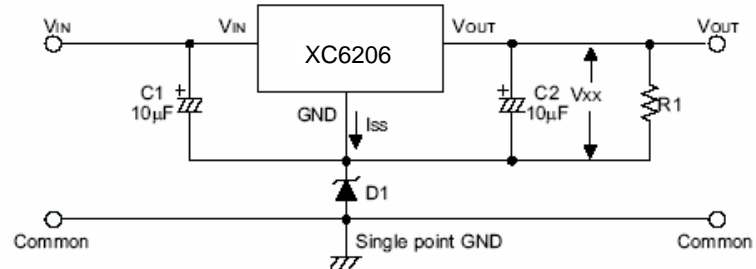

$$V_{OUT} = V_{XX} + V_{D1}$$

5、Constant current regulator

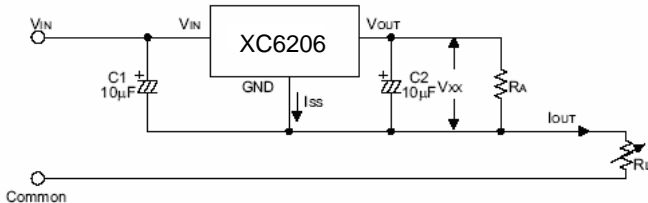

$$I_{OUT} = \frac{V_{XX}}{R_A} + I_{SS}$$

6、Dual supply

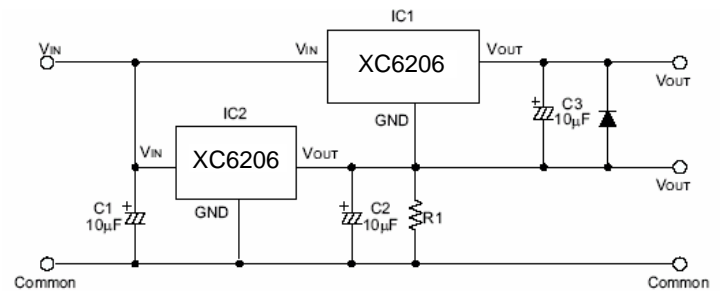

**Caution** The above connection diagram and constant will not guarantee successful operation. Perform thorough evaluation using the actual application to set the constant.

■ Application Conditions

Input capacitor (CIN): 1.0 $\mu$ F or more

Output capacitor (CL):0.1  $\mu$ F or more (tantalum capacitor)

**Caution** A general series regulator may oscillate, depending on the external components selected. Check that no oscillation occurs with the application using the above capacitor.

■ TYPICAL PERFORMANCE CHARACTERISTICS (3.0V output)

1. Output Voltage vs. Output Current

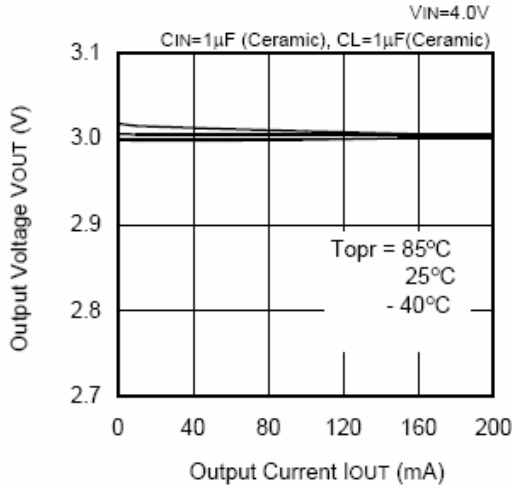

2. Output Voltage vs. Input Voltage

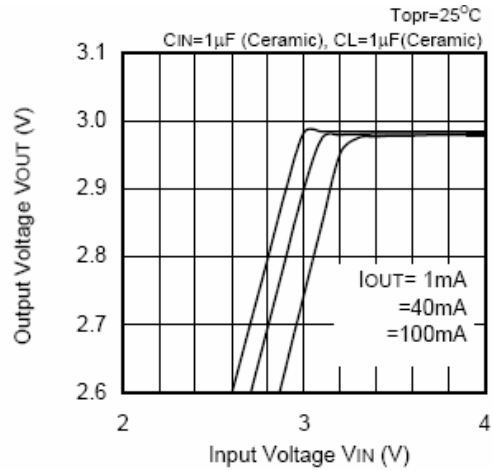

3. Dropout Voltage vs. Output Current

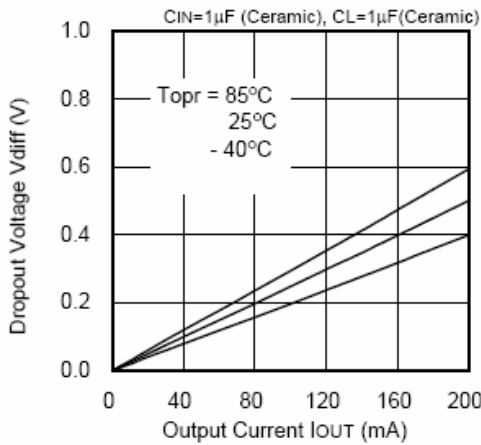

4. Dropout Voltage vs. Output Voltage

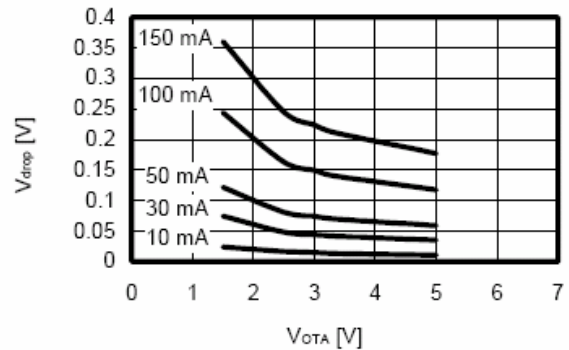

5. Output Voltage vs. Ambient Temperature

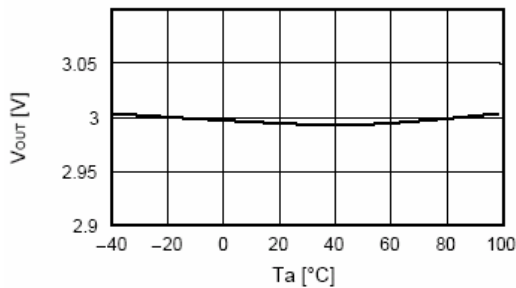

6. Ripple Rejection Rate

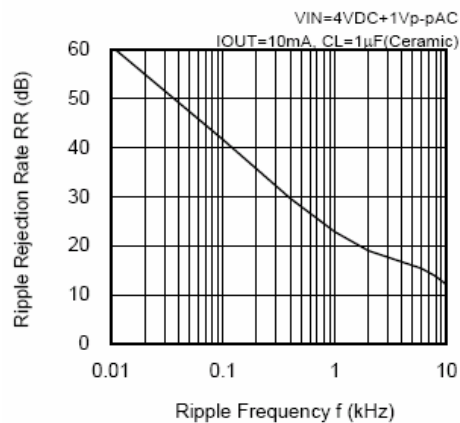

7. Transient Response

Input Transient Response

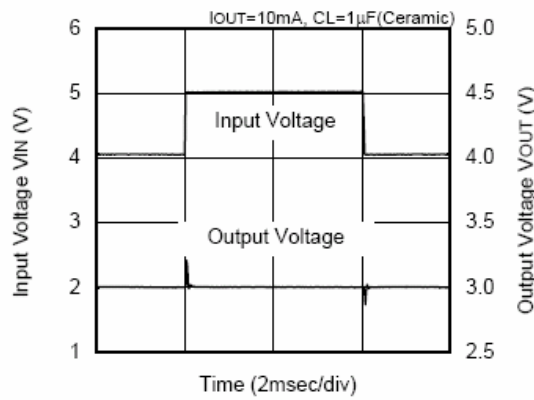

Load Transient Response

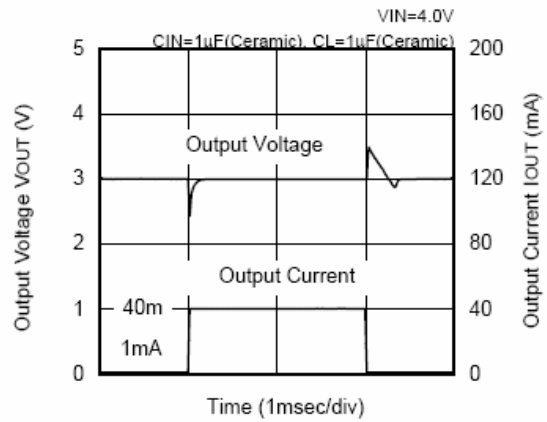

■ ORDERING INFORMATION

XC6206P①②③④⑤

DESIGNATOR	SYMBOL	DESCRIPTION
① ②	Integer	Output Voltage: e. g. ① =3, ② =0 → 3.0V
③	2	Accuracy: within ±2%
④	M	SOT-23
	P	SOT-89
	K	SOT353
	V	SOT23-3B
⑤	R	Embossed Tape: Standard Feed
	L	Embossed Tape: Reverse Feed

■ MARKING RULE

SOT-23, SOT23-3B & SOT-89

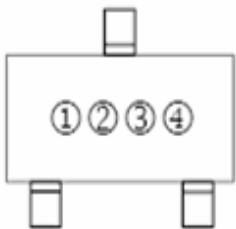

SOT23-3B(TOP VIEW)

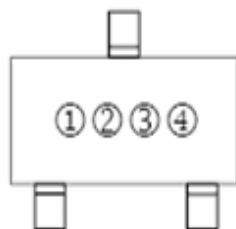

SOT-23 (TOP VIEW)

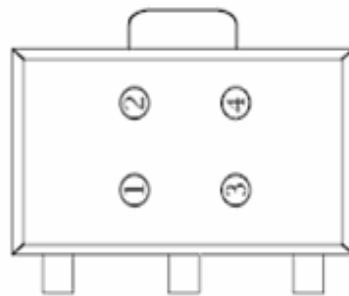

SOT-89 (TOP VIEW)

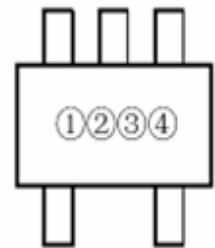

SOT353 (TOP VIEW)

① Represents product series

SYMBOL	PRODUCT SERIES
6	XC6206Pxxxxx

② Represents the type of regulator

VOLTAGE (V)	0.1~3.0	3.1~6.0	6.1~9.0
SYMBOL	5	6	7

③ Represents the Output Voltage

SYMBOL	OUTPUT VOLTAGE (V)			SYMBOL	OUTPUT VOLTAGE (V)		
0	-	3.1	-	F	1.6	4.6	-
1	-	3.2	-	H	1.7	4.7	-
2	-	3.3	-	K	1.8	4.8	-
3	-	3.4	-	L	1.9	4.9	-
4	-	3.5	-	M	2	5.0	-
5	-	3.6	-	N	2.1	5.1	-
6	-	3.7	-	P	2.2	5.2	-
7	-	3.8	-	R	2.3	5.3	-
8	-	3.9	-	S	2.4	5.4	-
9	-	4	-	T	2.5	5.5	-
A	-	4.1	-	U	2.6	5.6	-
B	1.2	4.2	-	V	2.7	5.7	-
C	1.3	4.3	-	X	2.8	5.8	-
D	1.4	4.4	-	Y	2.9	5.9	-
E	1.5	4.5	-	Z	3	6.0	-

④ Represents the assembly lot no.  
0~9, A~Z repeated (G, I, J, O, Q, W excepted)

■ PIN CONFIGURATION

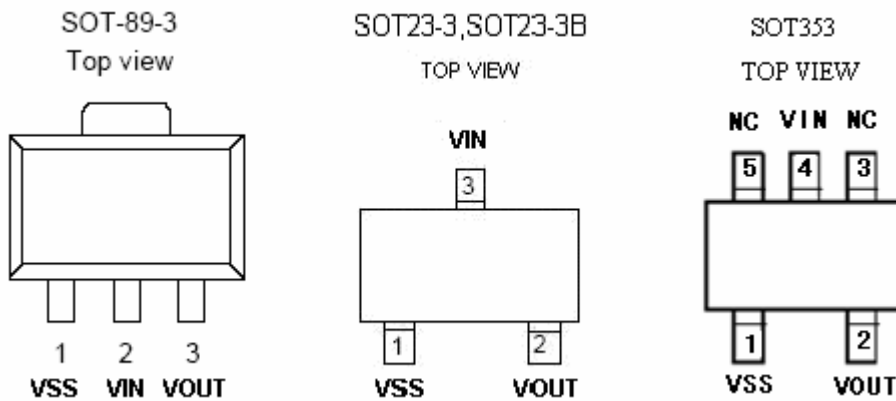

**Remark** Please contact the Natlinear marketing department for other packages.

■ PACKAGING INFORMATION

SOT-89-3

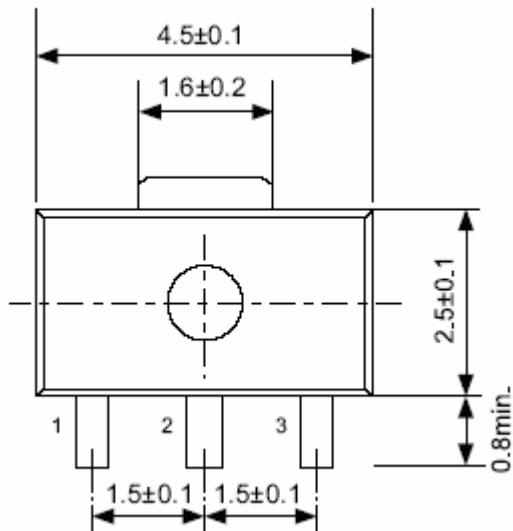

SOT23-3/SOT23-3B

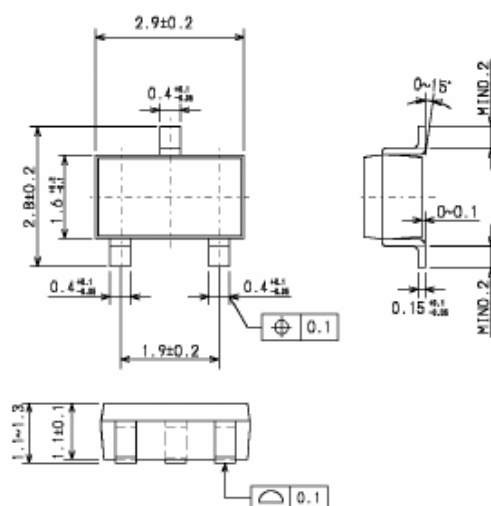

SOT353

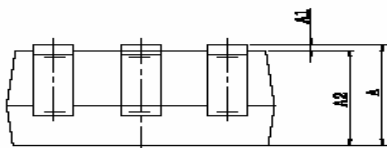
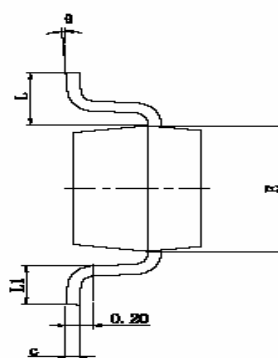
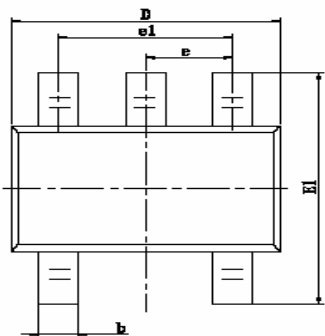

Symbol	Dimensions In Millimeters		Dimensions In Inches	
	Min	Max	Min	Max
A	0.900	1.100	0.035	0.043
A1	0.000	0.100	0.000	0.004
A2	0.900	1.000	0.035	0.039
b	0.150	0.350	0.006	0.014
c	0.080	0.150	0.003	0.006
D	2.000	2.200	0.079	0.087
E	1.150	1.350	0.045	0.053
E1	2.150	2.450	0.085	0.096
e	0.650 TYP		0.026 TYP	
e1	1.200	1.400	0.047	0.055
L	0.525 REF		0.021 REF	
L1	0.260	0.460	0.010	0.018
θ	0°	8°	0°	8°