

SPECIFICATION

- Part No. : **PA.700.J**
- Product Name : Samurai Hexa-Band Cellular SMD Antenna
- Feature : Designed for Japan LTE frequency bands
Covers all in one 4G/3G/2G applications
700~2600MHz
LTE / GSM / CDMA / DCS / PCS / WCDMA / UMTS
/HSDPA / GPRS / EDGE
High efficiency wide-band antenna
Patent pending
SMT for precision mounting and labor saving
40*6*5mm
RoHS ✓

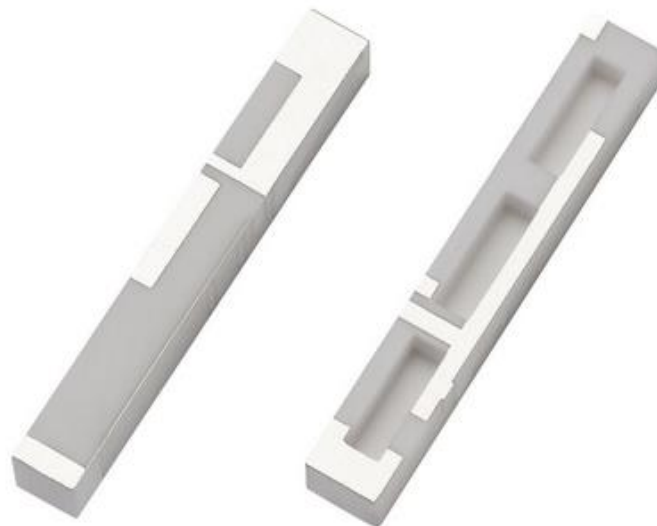

1. Introduction

This revolutionary patent pending Samurai PA.700.J is a 4G/3G/2G high efficiency SMD ceramic antenna operating at 700MHz to 960MHz, 1400MHz to 2600MHz to cover all LTE frequency bands applied in Japan. It uses high grade ceramics to deliver the highest efficiencies on all bands on the shortest device ground-plane lengths possible. The exceptional wide-band response means it covers all standardly used operation bands around the globe.

1.1. Key Advantages

1. Highest efficiency in small size 40mm*6mm*5mm. A comparative metal, FR4, FPC, whip, rod, helix antenna, would have much more reduced efficiency in this configuration for the same size due to their different dielectric constants. Very high efficiency antennas are critical to 3G and 4G devices ability to deliver the stated data-speed rates of systems such as HSPA and LTE.
2. More resistant to detuning compared to other antenna integrations. If tuning is required it can be tuned for the device environment using a matching circuit or other techniques. There is no need for new tooling, thereby saving money if customization is required.
3. Highly reliable and robust- its predecessor the PA.25 antenna is used by the world's leading auto makers in extremely challenging environments. The antenna meets all temperature and mechanical specs required (vibration, drop tests etc.)
4. Rectangular shape - Easy to integrate. Other antenna designs come in irregular shapes and sizes making them hard to integrate.
5. SMD (On-Board) antenna saves on labor, cable and connector costs, leads to higher integration yield rates, and reduces losses in transmission.
6. It mounts directly on edge of device main-board.
7. Transmission losses are kept to absolute minimum resulting in much improved over the air (OTA) TRP (Total Radiated Power) / TIS (Total Isotropic Radiation) device performance compared to similar efficiency cable and connector antenna solutions.

8. Reductions in probability of radiated spurious emissions compared to other antenna technologies are observed when using the PA.700.J and strictly following this application note layout

9. Achieves moderate to high gain in both vertical and horizontal polarization planes. This feature is very useful in certain wireless communications where the antenna orientation is not fixed and the reflections or multipath signals may be present from any plane. In those cases the important parameter to be considered is the total field strength, which is the vector sum of the signal from the horizontal and vertical polarization planes at any instant in time.

LTE Bands (Japan)		Frequency
1	2100	1920~2170MHz
6	800	830~885MHz
8	900	880~960MHz
9	1700	1749~1880MHz
11	1500	1427~1496MHz
18	800	815~875MHz
19	800	832~889MHz
21	1500	1447~1510MHz
41	2500	2496~2690MHz

2. Specification

ELECTRICAL					
Antenna	PA700J				
Standard	4G/3G/G				
Operation Frequency (MHz)	698~800	824~960	1410~1520	1710~2170	2400~2700
Peak Gain	-3.6 dBi	-0.5 dBi	-1.0 dBi	0.5 dBi	2.7 dBi
Average Gain	-5.5 dB	-2.0 dB	-2.5 dB	-2.8 dB	-2.4
Efficiency	30 %	63%	55 %	53%	57%
Return Loss [dB]	-5.0 dB	-14.0 dB	-7.0 dB	-7.0 dB	-7.5 dB
VSWR	<3.5:1				
Impedance	50Ω				
Polarization	Linear				
Radiation Properties	Omni-directional				
Max Input Power	5 W				

* ThePA.700.J antenna performance was measured with 106.5x44 mm ground plane.

MECHANICAL	
Dimensions (mm)	40 x 6 x 5 mm
Material	Ceramic
Termination	Ag (environmental-friendly Pb free)
EVB Connector	SMA-Female

ENVIRONMENTAL	
Operation Temperature	-40°C to 85°C
Storage Temperature	-40°C to 105°C
Relative Humidity	Non-condensing 65°C 95% RH
RoHs Compliant	Yes

* All electrical properties are measured with PA.700.J mounted on its EVB with 106.5x44mm ground.

2.1 LTE Bands – On 50*50mm Ground Plane

LTE BANDS			
Band Number	LTE / LTE-Advanced / WCDMA / HSPA / HSPA+ / TD-SCDMA		
	Uplink	Downlink	Covered
1	UL: 1920 to 1980	DL: 2110 to 2170	✓
2	UL: 1850 to 1910	DL: 1930 to 1990	✓
3	UL: 1710 to 1785	DL: 1805 to 1880	✓
4	UL: 1710 to 1755	DL: 2110 to 2155	✓
5	UL: 824 to 849	DL: 869 to 894	✗
7	UL: 2500 to 2570	DL: 2620 to 2690	✓
8	UL: 880 to 915	DL: 925 to 960	✗
9	UL: 1749.9 to 1784.9	DL: 1844.9 to 1879.9	✓
11	UL: 1427.9 to 1447.9	DL: 1475.9 to 1495.9	✓
12	UL: 699 to 716	DL: 729 to 746	✗
13	UL: 777 to 787	DL: 746 to 756	✗
14	UL: 788 to 798	DL: 758 to 768	✗
17	UL: 704 to 716	DL: 734 to 746 (LTE only)	✗
18	UL: 815 to 830	DL: 860 to 875 (LTE only)	✗
19	UL: 830 to 845	DL: 875 to 890	✗
20	UL: 832 to 862	DL: 791 to 821	✗
21	UL: 1447.9 to 1462.9	DL: 1495.9 to 1510.9	✓
22	UL: 3410 to 3490	DL: 3510 to 3590	✗
23	UL: 2000 to 2020	DL: 2180 to 2200 (LTE only)	✓
24	UL: 1625.5 to 1660.5	DL: 1525 to 1559 (LTE only)	✓
25	UL: 1850 to 1915	DL: 1930 to 1995	✓
26	UL: 814 to 849	DL: 859 to 894	✗
27	UL: 807 to 824	DL: 852 to 869 (LTE only)	✗
28	UL: 703 to 748	DL: 758 to 803 (LTE only)	✗
29	UL: -	DL: 717 to 728 (LTE only)	✗
30	UL: 2305 to 2315	DL: 2350 to 2360 (LTE only)	✓
31	UL: 452.5 to 457.5	DL: 462.5 to 467.5 (LTE only)	✗
32	UL: -	DL: 1452 - 1496	✓
35		1850 to 1910	✓
38		2570 to 2620	✓
39		1880 to 1920	✓
40		2300 to 2400	✓
41		2496 to 2690	✓
42		3400 to 3600	✗
43		3600 to 3800	✗

2.2 LTE Bands – On 100*100mm Ground Plane

LTE BANDS			
Band Number	LTE / LTE-Advanced / WCDMA / HSPA / HSPA+ / TD-SCDMA		
	Uplink	Downlink	Covered
1	UL: 1920 to 1980	DL: 2110 to 2170	✓
2	UL: 1850 to 1910	DL: 1930 to 1990	✓
3	UL: 1710 to 1785	DL: 1805 to 1880	✓
4	UL: 1710 to 1755	DL: 2110 to 2155	✓
5	UL: 824 to 849	DL: 869 to 894	✓
7	UL: 2500 to 2570	DL: 2620 to 2690	✓
8	UL: 880 to 915	DL: 925 to 960	✓
9	UL: 1749.9 to 1784.9	DL: 1844.9 to 1879.9	✓
11	UL: 1427.9 to 1447.9	DL: 1475.9 to 1495.9	✓
12	UL: 699 to 716	DL: 729 to 746	✗
13	UL: 777 to 787	DL: 746 to 756	✗
14	UL: 788 to 798	DL: 758 to 768	✓
17	UL: 704 to 716	DL: 734 to 746 (LTE only)	✗
18	UL: 815 to 830	DL: 860 to 875 (LTE only)	✓
19	UL: 830 to 845	DL: 875 to 890	✓
20	UL: 832 to 862	DL: 791 to 821	✓
21	UL: 1447.9 to 1462.9	DL: 1495.9 to 1510.9	✓
22	UL: 3410 to 3490	DL: 3510 to 3590	✗
23	UL: 2000 to 2020	DL: 2180 to 2200 (LTE only)	✓
24	UL: 1625.5 to 1660.5	DL: 1525 to 1559 (LTE only)	✓
25	UL: 1850 to 1915	DL: 1930 to 1995	✓
26	UL: 814 to 849	DL: 859 to 894	✓
27	UL: 807 to 824	DL: 852 to 869 (LTE only)	✓
28	UL: 703 to 748	DL: 758 to 803 (LTE only)	✗
29	UL: -	DL: 717 to 728 (LTE only)	✗
30	UL: 2305 to 2315	DL: 2350 to 2360 (LTE only)	✓
31	UL: 452.5 to 457.5	DL: 462.5 to 467.5 (LTE only)	✗
32	UL: -	DL: 1452 - 1496	✓
35		1850 to 1910	✓
38		2570 to 2620	✓
39		1880 to 1920	✓
40		2300 to 2400	✓
41		2496 to 2690	✓
42		3400 to 3600	✗
43		3600 to 3800	✗

2.1. Test Set-up

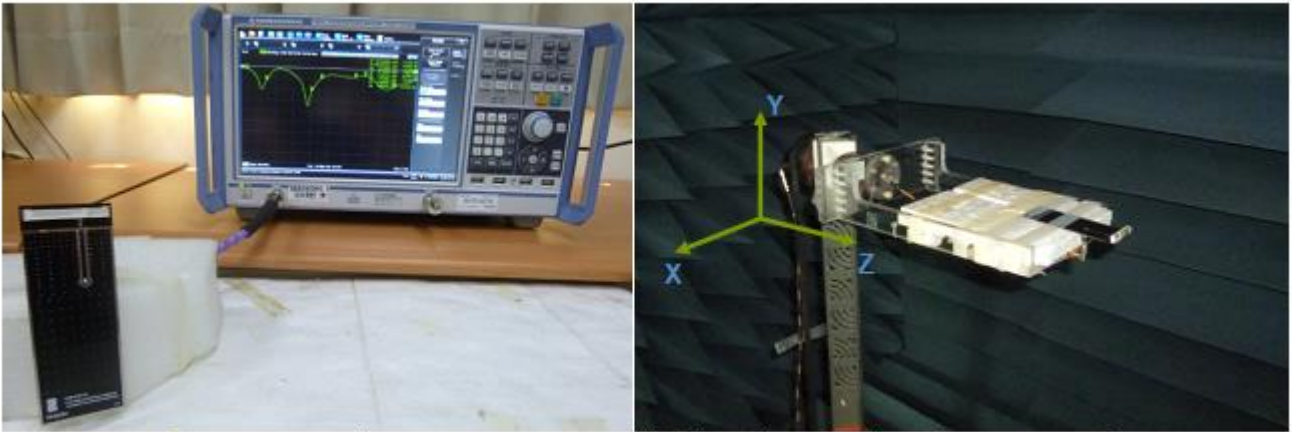

Figure 1. Impedance measurements (left hand) and peak gain, average gain, efficiency and radiation pattern measurements (right hand).

2.2. Return Loss

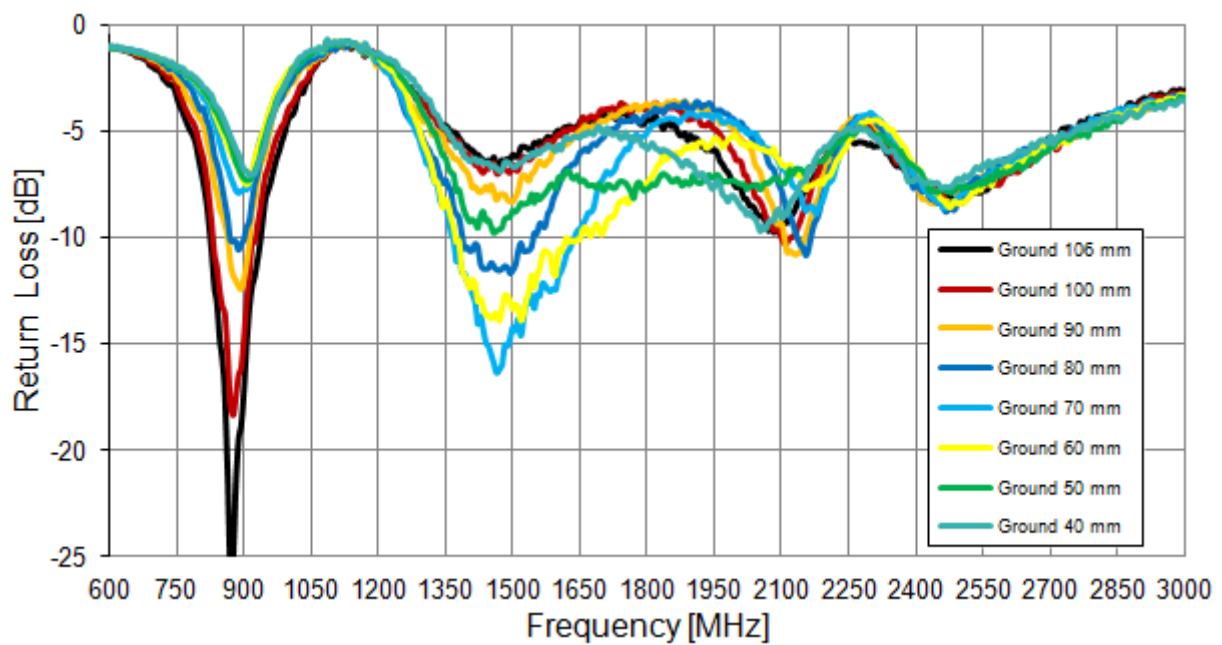

Figure 2. Return Loss of the PA700J LTE antenna.

2.3. VSWR

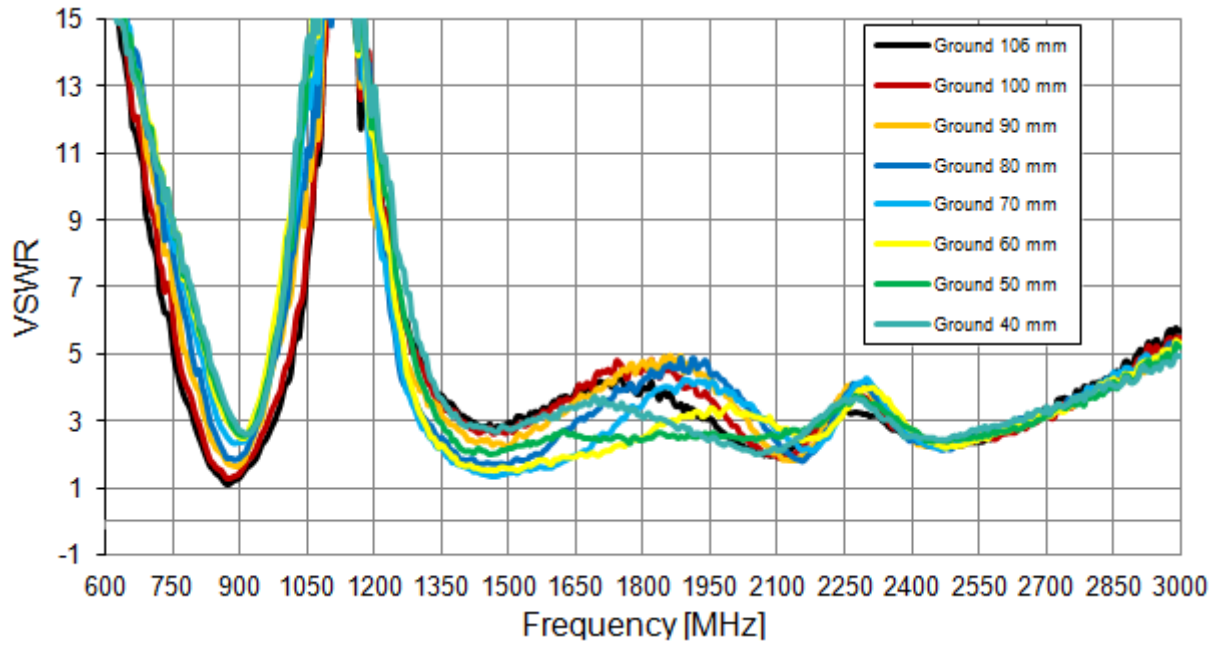

Figure 3. VSWR of the PA700J LTE antenna.

2.4. Efficiency

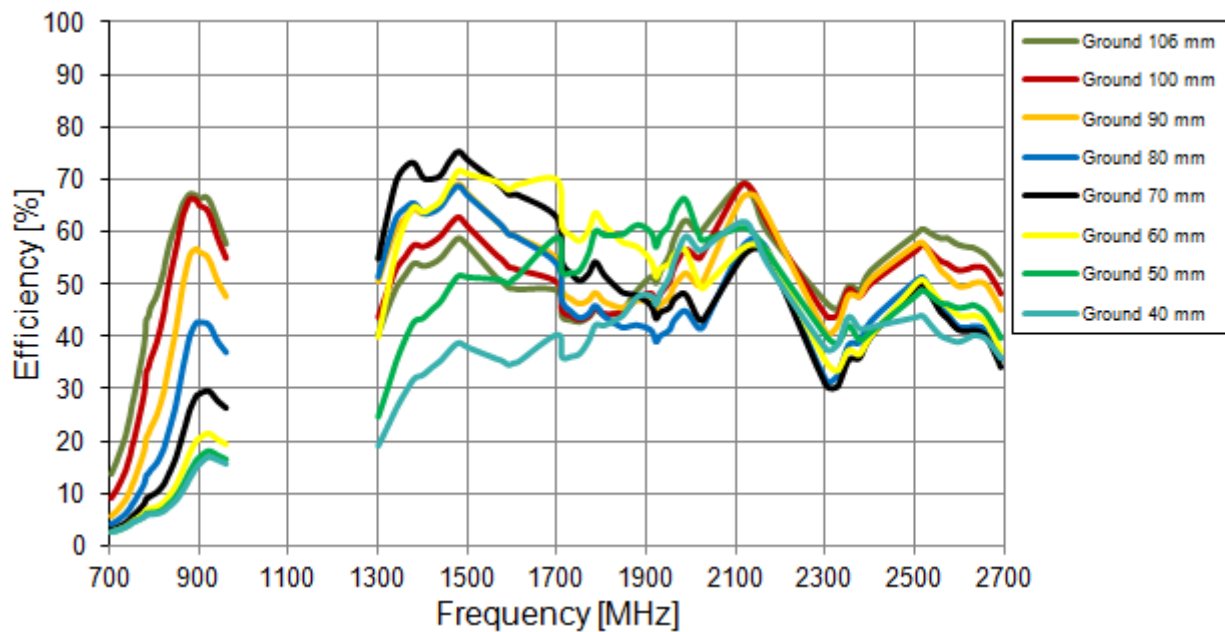

Figure 4. Efficiency of the PA700J LTE antenna.

2.5. Peak Gain

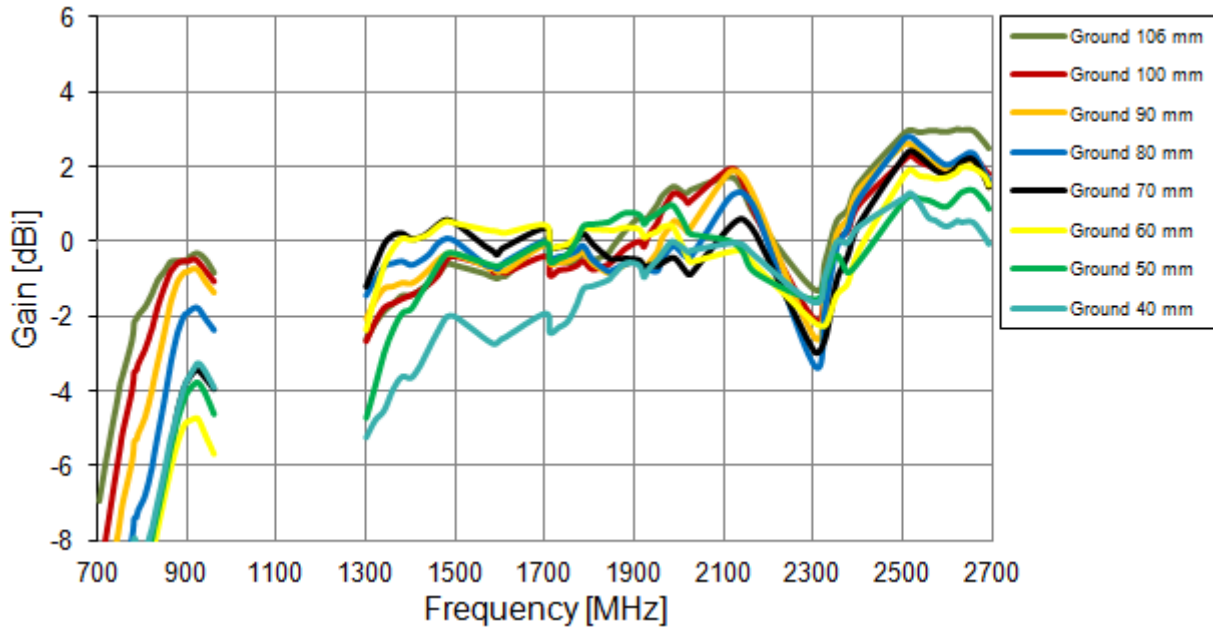

Figure 5. Peak Gain of the PA700J LTE antenna.

2.6. Average Gain

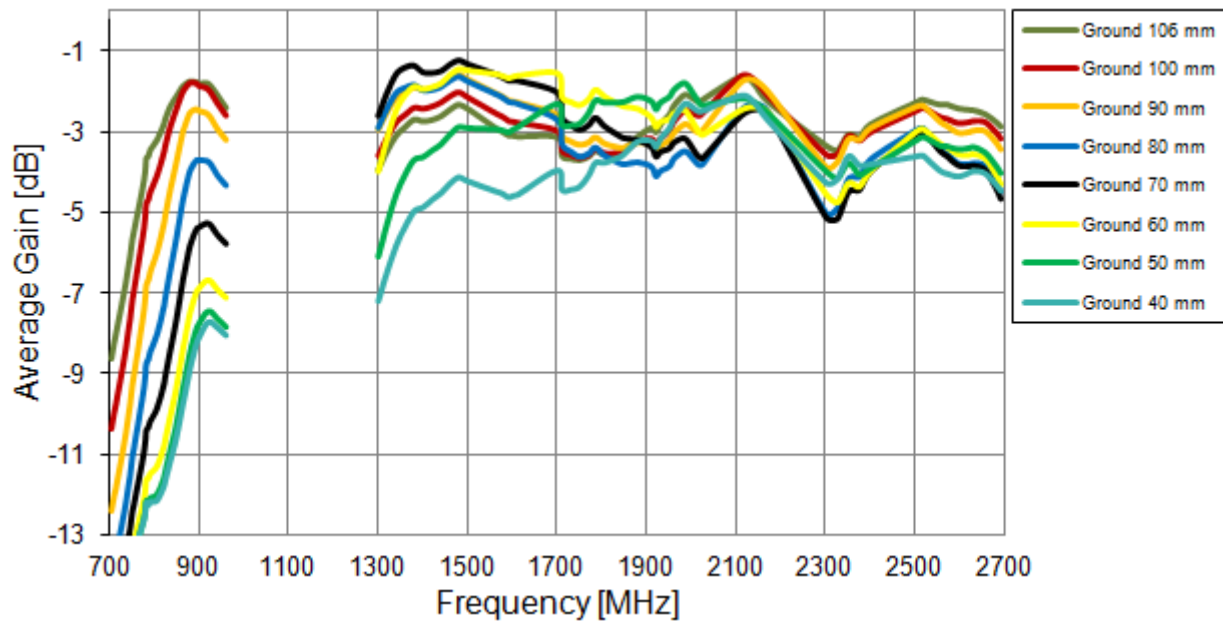

Figure 6. Average Gain of the PA700J LTE antenna.

2.7. 3D Radiation Pattern

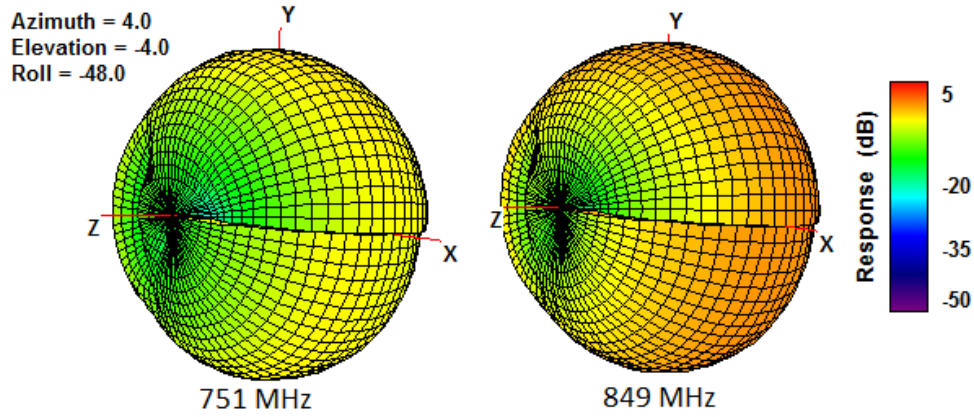

Figure 7. 3D Radiation Pattern at 751 MHz and 849 MHz of the PA700J Antenna.

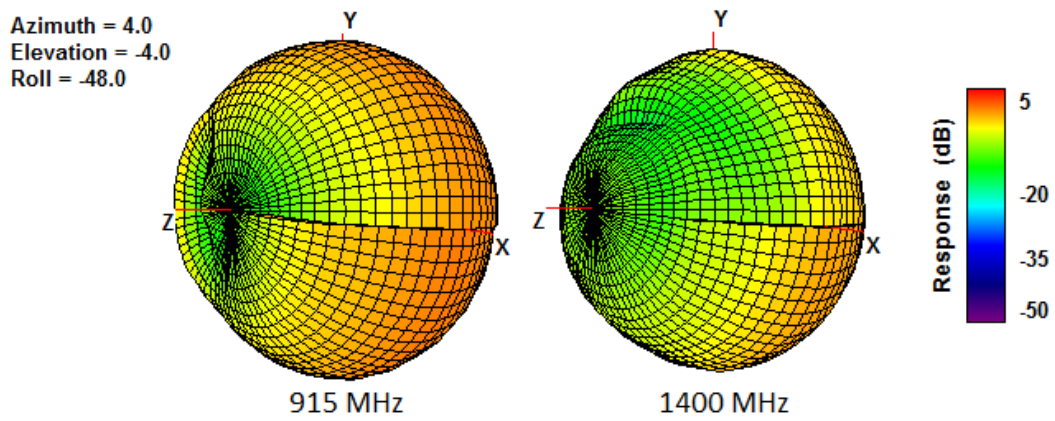

Figure 8. 3D Radiation Pattern at 915 MHz and 1400 MHz of the PA700J Antenna.

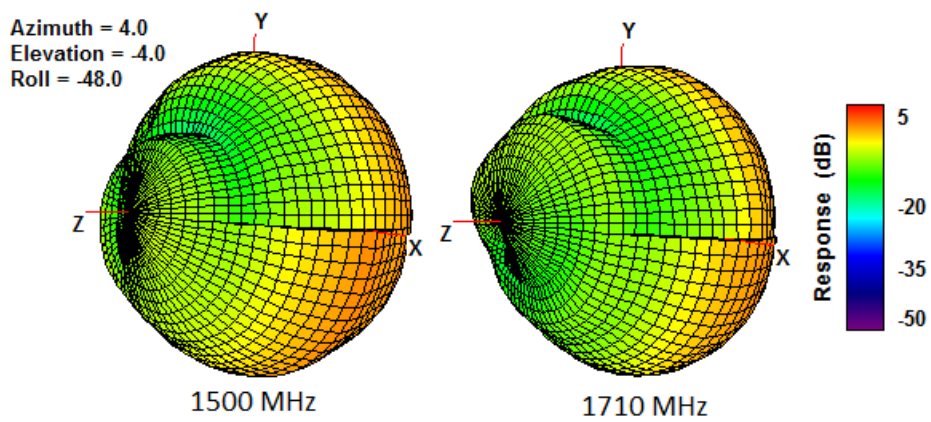

Figure 9. 3D Radiation Pattern at 1500 MHz and 1710 MHz of the PA700J Antenna.

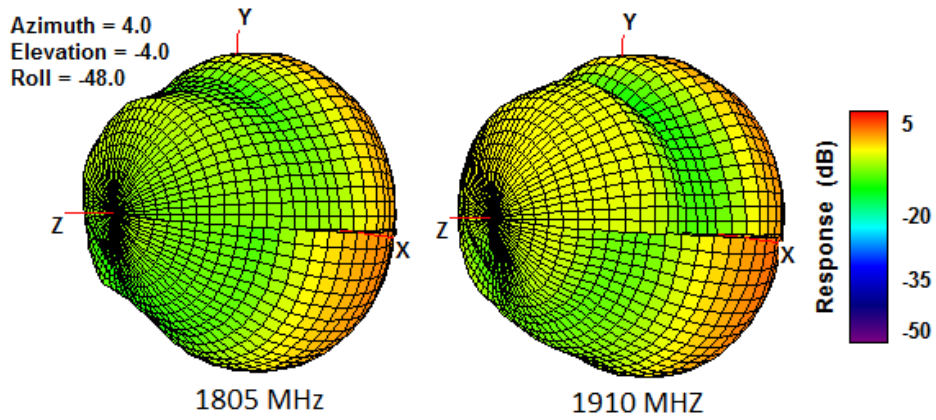

Figure 10. 3D Radiation Pattern at 1805 MHz and 1910 MHz of the PA700J Antenna.

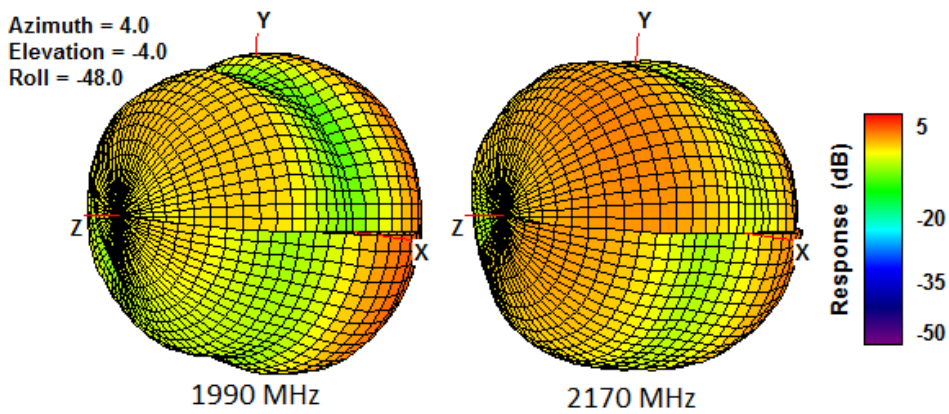

Figure 11. 3D Radiation Pattern at 1990 MHz and 2170 MHz of the PA700J Antenna.

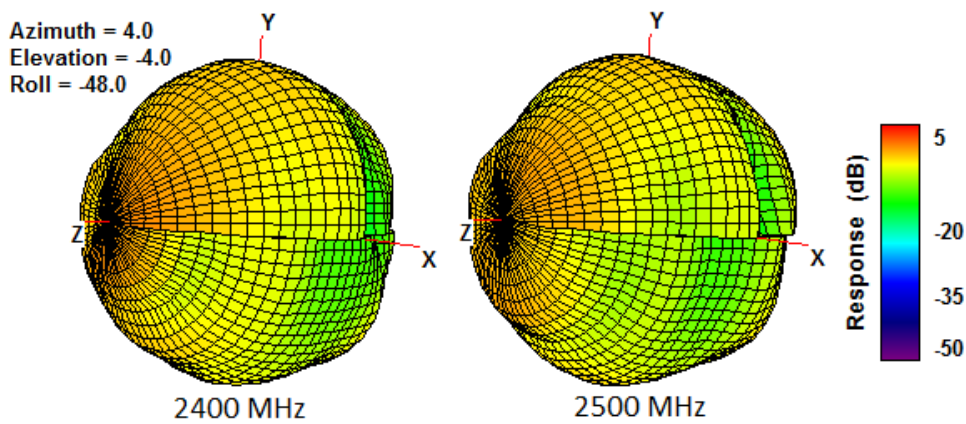
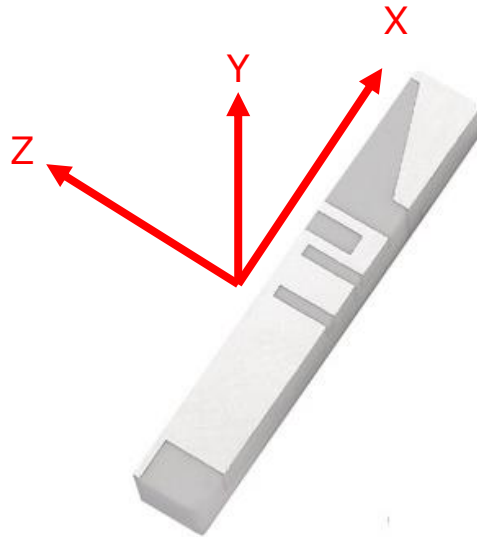
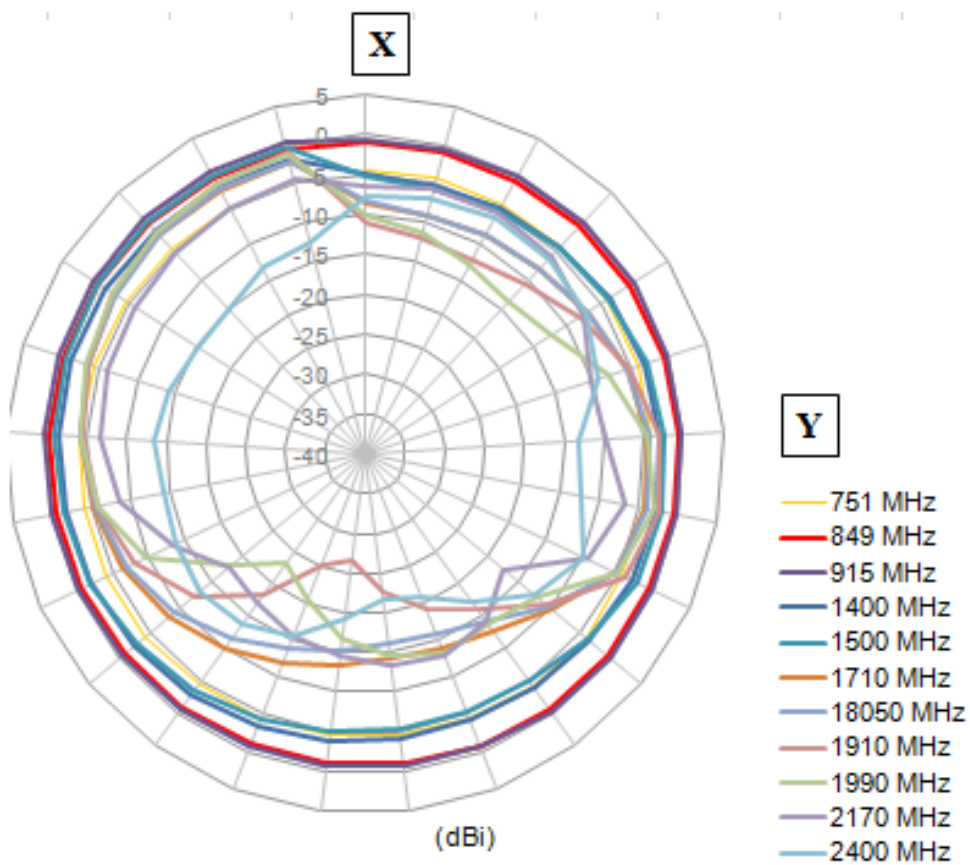

Figure 12. 3D Radiation Pattern at 2400 and 2500 MHz of the PA700J Antenna.

2.8. 2D Radiation Pattern



XY Plane



XZ Plane

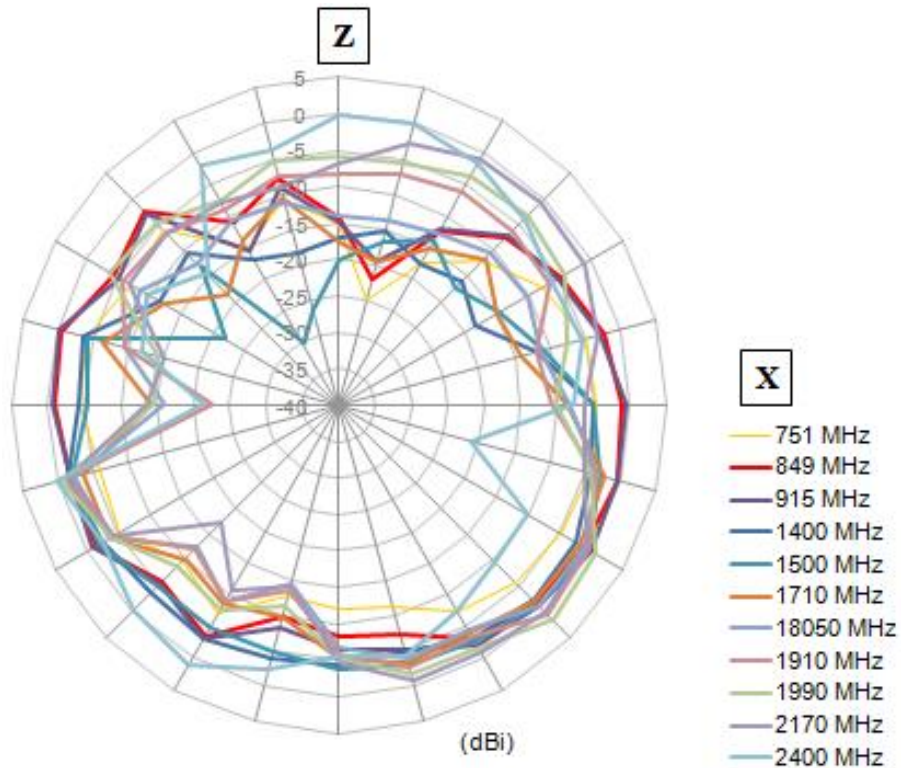

YZ Plane

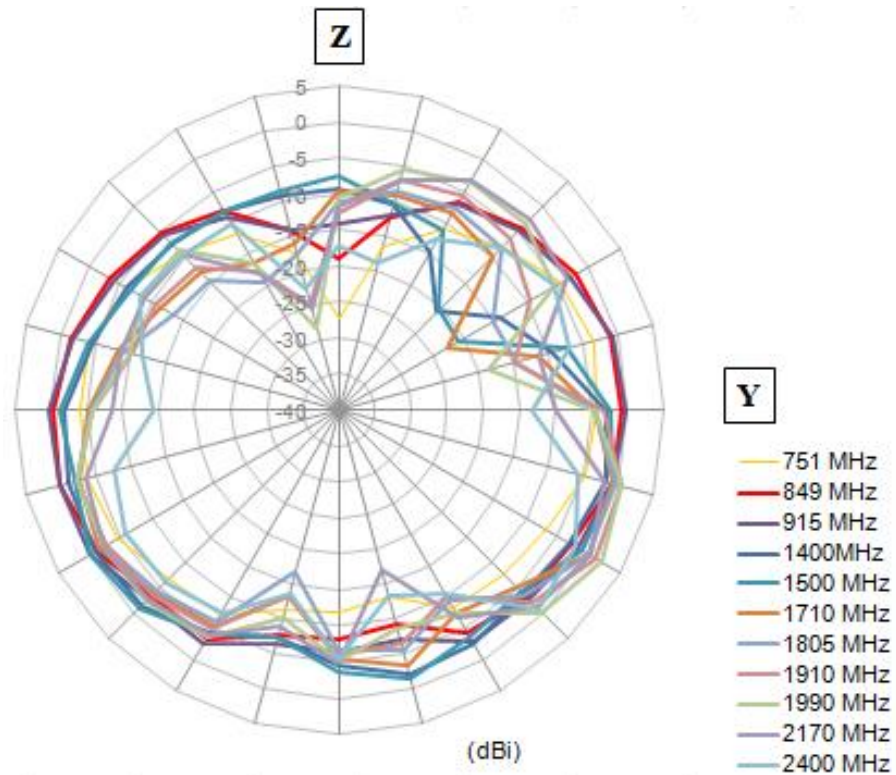
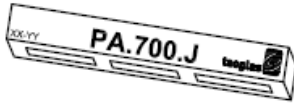
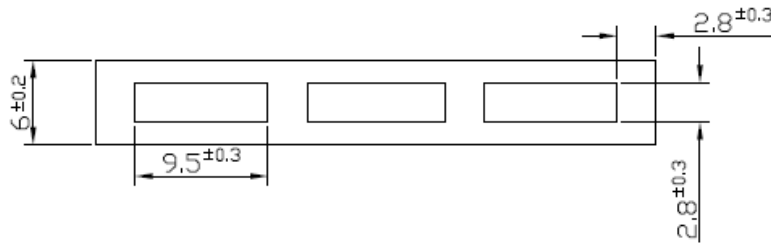

Figure 13. 2D Radiation Pattern of the PA700J Antenna.

3. Mechanical Drawing (Unit: mm)



3D View



Bottom



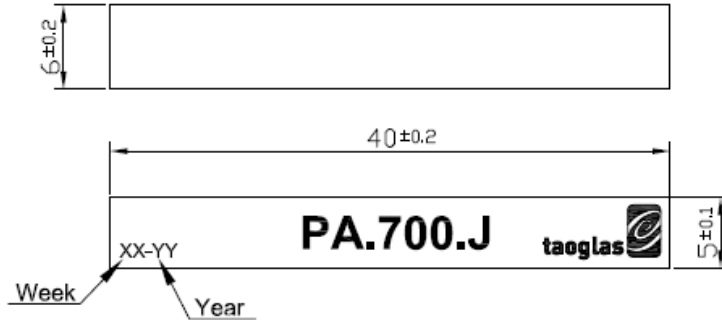

Top



Note: Inductor Value 8.2nH for Taoglas Evaluation Board – different values may be required for different board designs

Note:

1. Week Batch Code
Example: 2012 Week 1=01.12
2. Copper Area 
3. Clearance Area 
4. Soldered Area 
5. Logo & Text Ink Printing : Black

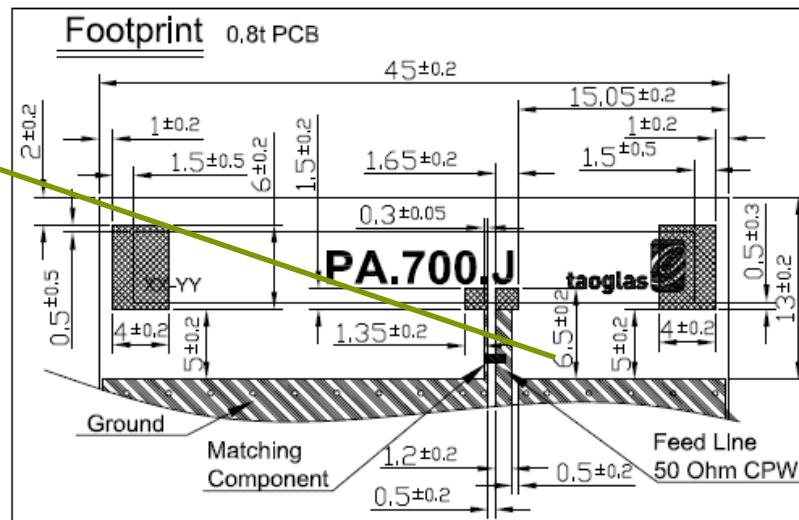
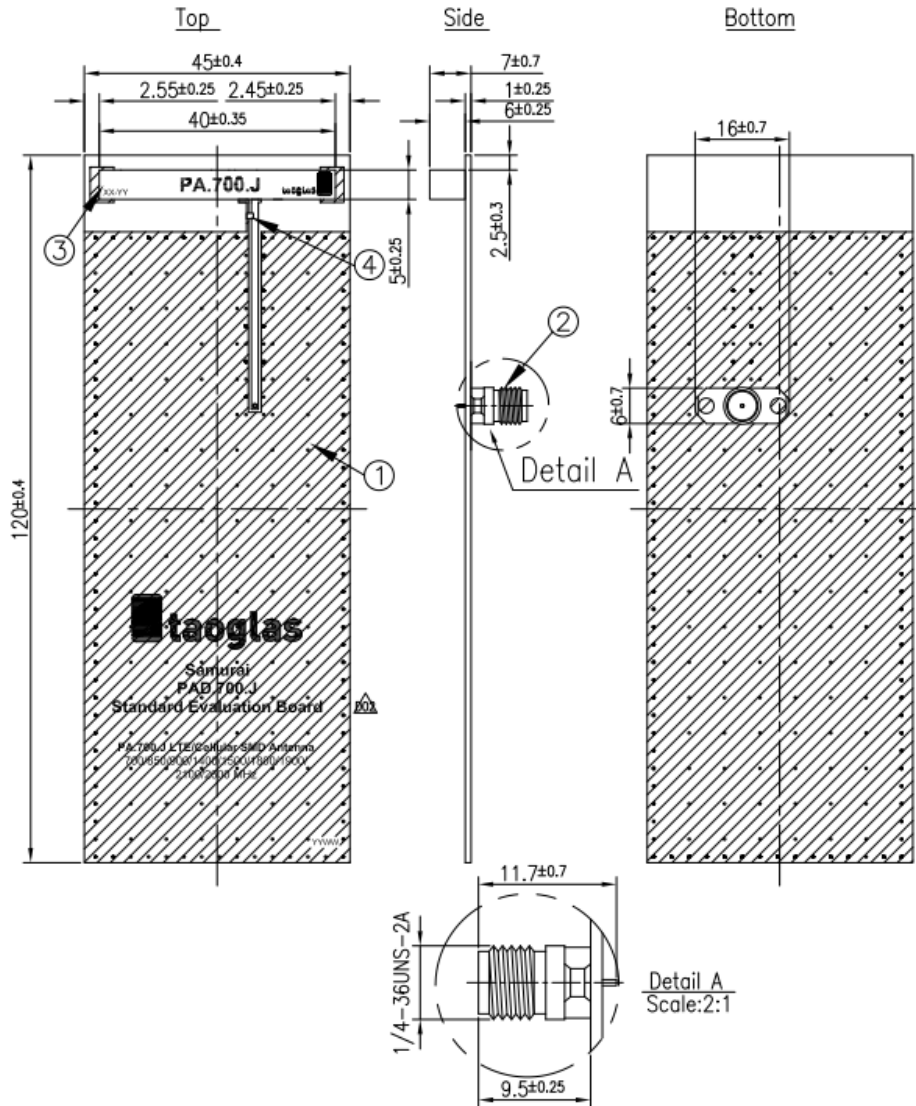

Figure 14. Mechanical Drawing of the PA700J Antenna.

4. EVB Dimensions (Unit: mm)



	Name	Material	Finish	QTY
1	PA.700.J EVB PCB	Composite	Black	1
2	SMA(F) ST PCB	Brass	Gold	1
3	PA.700.J Antenna	Ceramic	White	1
4	L=8.2nH Inductor	Ceramic	N/A	1

Figure 15. Drawing of the PAD.700.J Antenna

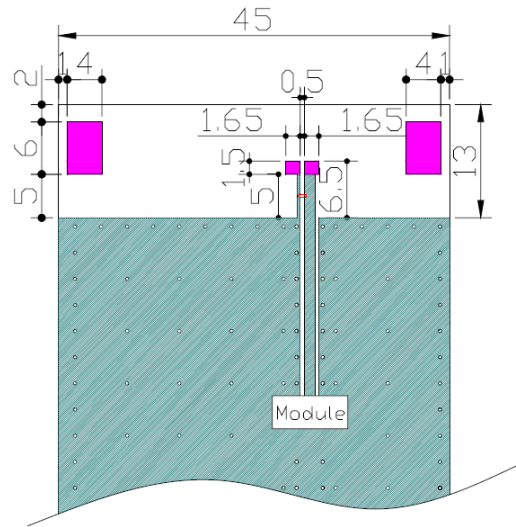

Figure 16. Layout dimensions of the PA700J Antenna.

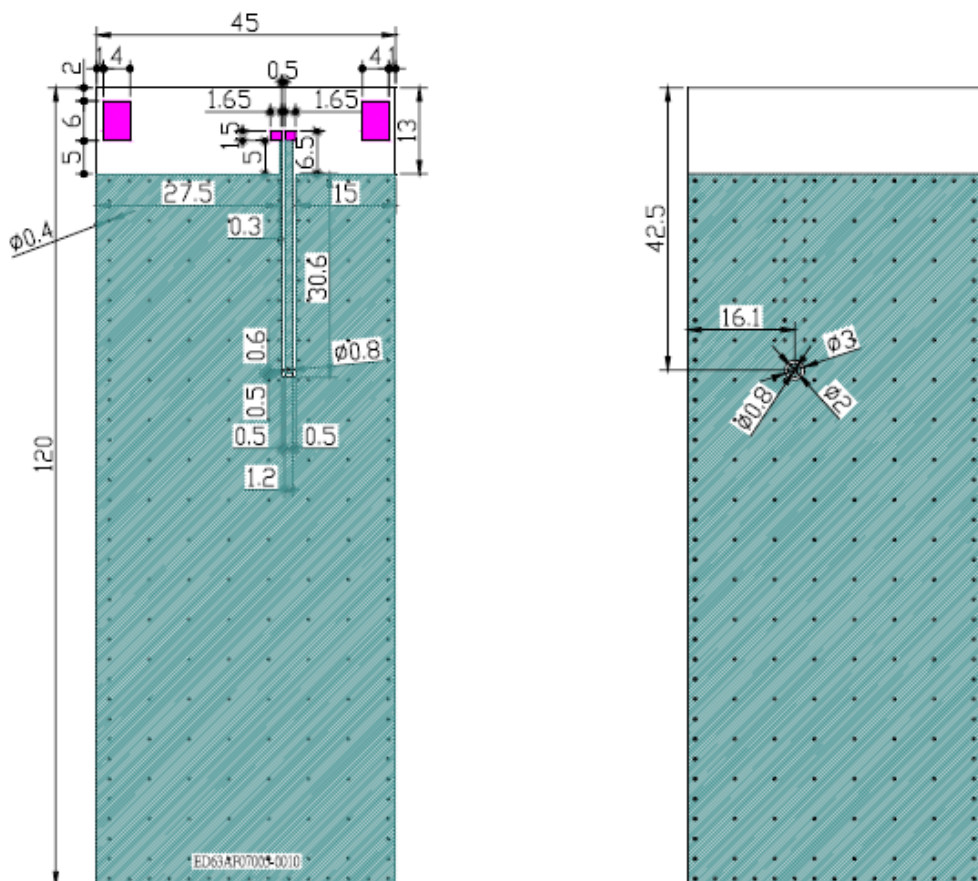

Figure 17. EVB Dimensions of the PA700J.

5. Packaging

Blister tape to IEC 286-3, Polyester

Pieces / Tape = 450

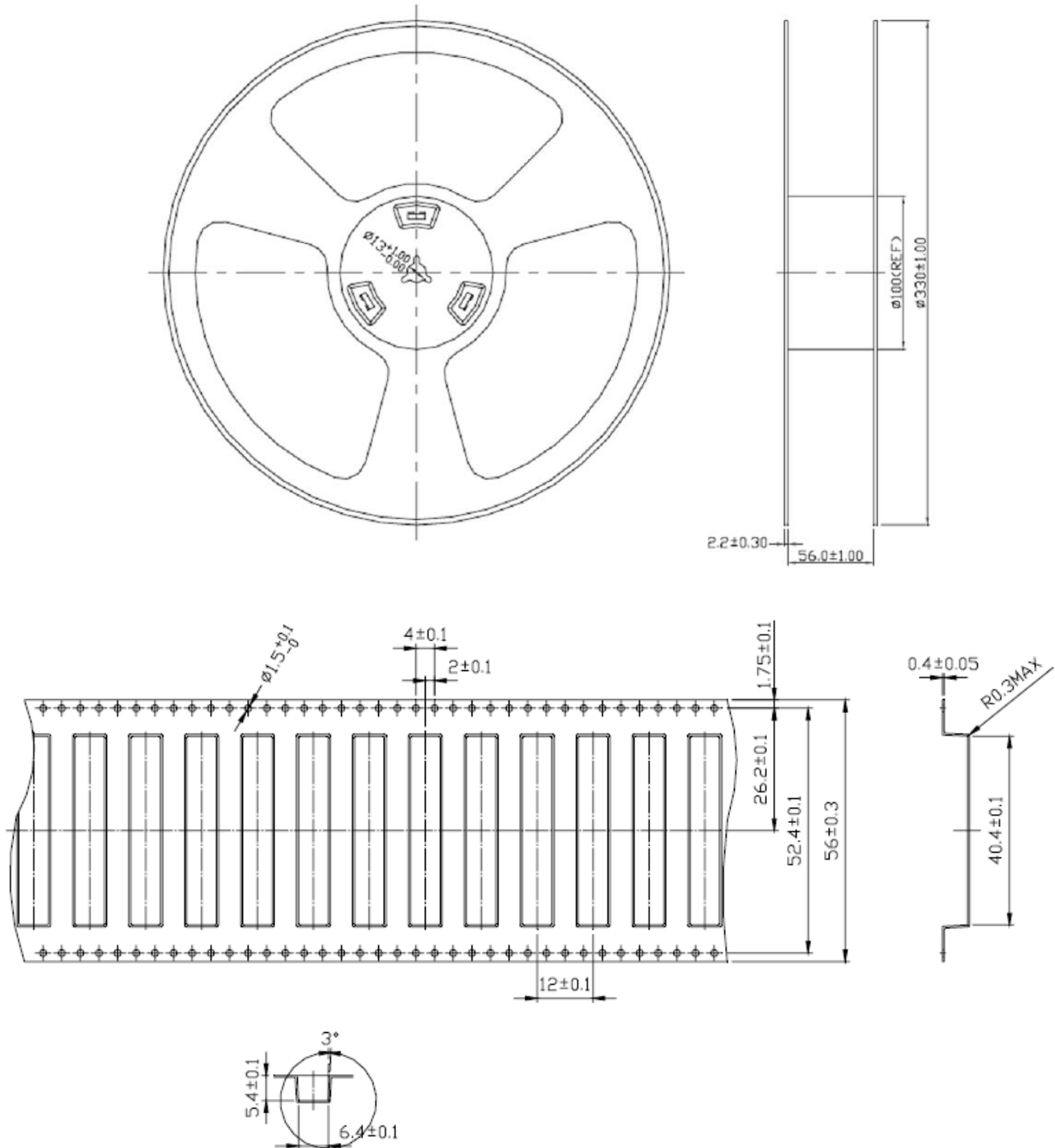
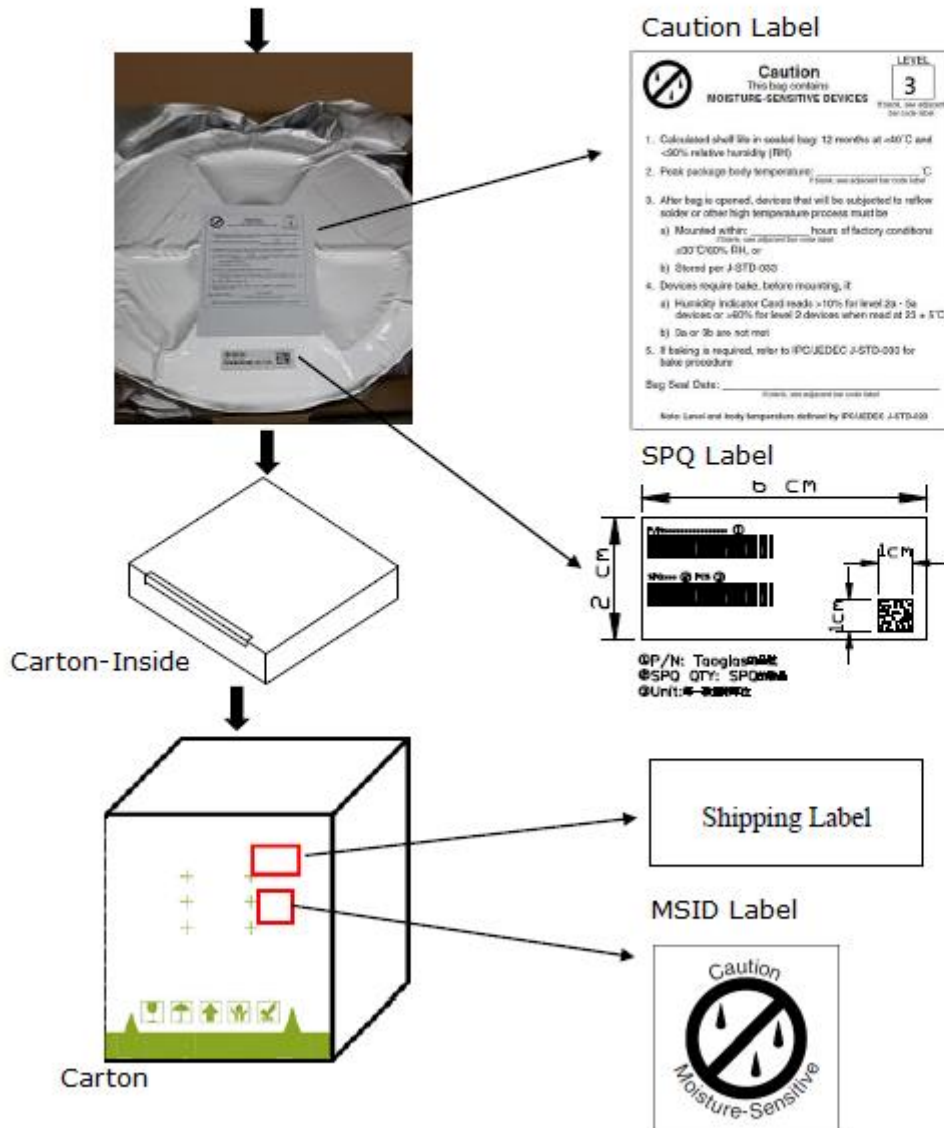
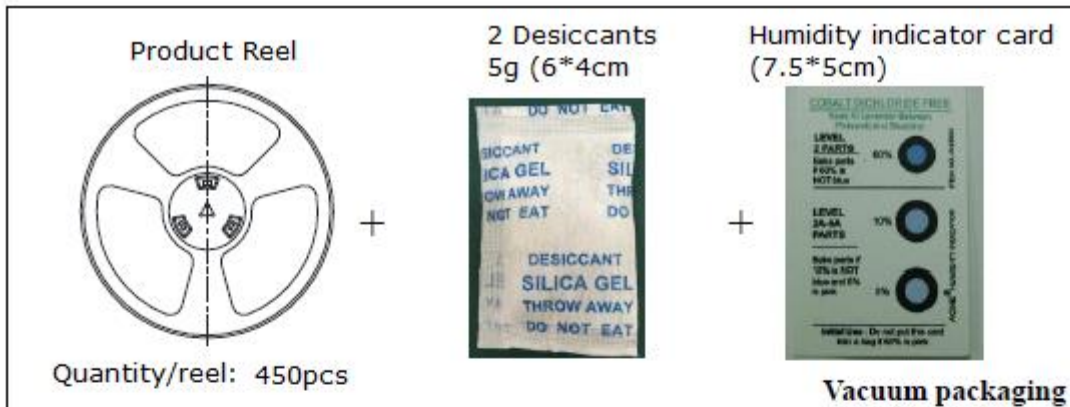

Figure 18. Packing



6. Recommended Reflow Profile

PA.700.J can be assembled following either Sn-Pb or Pb-Free assembly processes. The recommended soldering temperatures are as follows:

Phase	Profile Features	Sn-Pb Assembly	Pb-Free Assembly (SnAgCu)
Ramp-Up	Avg. Ramp-Up Rate (T _{smax} to TP)	3°C/second (max)	3°C/second (max)
Preheat	Temperature Min (T _{smin})	100°	100°
	Temperature Max (T _{smax})	150°	150°
	Time (t _{smin} to t _{smax})	60-120 seconds	60-120 seconds
Reflow	Temperature (TL)	183°C	217°C
	Total Time Above TL b(t _L)	60-150 seconds	60-150 seconds
Peak	Temperature (T _p)	235°C	260°C
	Time (t _p)	10-30 seconds	20-40 seconds
Ramp-Down	Rate	6°C/second (max)	6°C/second (max)
Time from 25°C to peak Temperature		6 minutes max	8 minutes max

Temperature profile – (green area) for the assembly process in reflow ovens

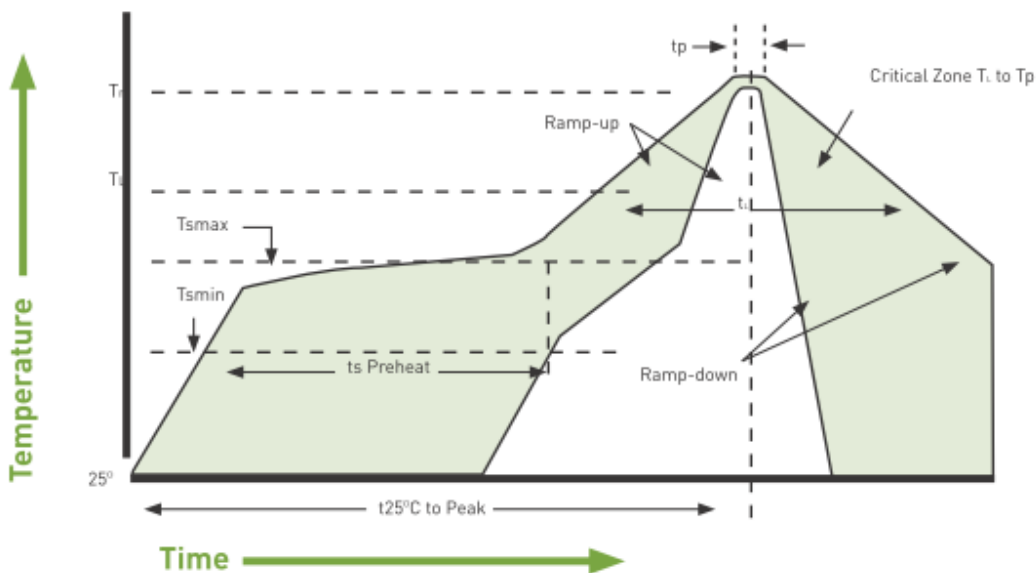

Figure 19. Temperature profile for the assembly process in reflow ovens.

Taoglas makes no warranties based on the accuracy or completeness of the contents of this document and reserves the right to make changes to specifications and product descriptions at any time without notice. Taoglas reserves all rights to this document and the information contained herein.

Reproduction, use or disclosure to third parties without express permission is strictly prohibited.

Copyright © Taoglas Ltd.