

Features

- Low gate charge
- Trench FS Technology,
- saturation voltage: $V_{CE(sat)}$, type =1.75V, $I_c=30A$ and $T_C =25^{\circ}C$
- RoHS product

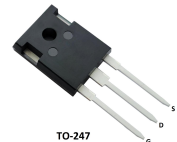
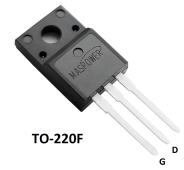
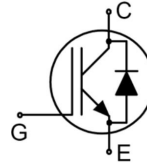

Applications

- General purpose inverters
- UPS

Absolute Ratings ($T_c=25^{\circ}C$)

Parameter	Symbol	Value	Unit
Collector-Emmitter Voltage	V_{ces}	650	V
*Collector Current-continuous	I_c $T=25^{\circ}C$ $T=100^{\circ}C$	60	A
		30	A
Collector Current-pulse(note 1)	I_{CM}	120	A
Diode RMS forward current	I_F $T=25^{\circ}C$ $T=100^{\circ}C$	60	A
		30	A
Gate-Emmitter Voltage	V_{GES}	± 20	V
Turn-off safe area	-	120	A
Surge non repetitive forward current $t_p=10ms$ sinusoidal	I_{FSM}	120	A
Power Dissipation(TO-220)	P_D $T_c=25^{\circ}C$	63	W
Power Dissipation(TO-247)	P_D $T_c=25^{\circ}C$	160	W
Power Dissipation(TO-220F)	P_D $T_c=25^{\circ}C$	46	W
Operating Temperature Range	T_J	-55~175	$^{\circ}C$
Storage Temperature Range	T_{STG}	-55~+150	$^{\circ}C$
Maximum Lead Temperature for Soldering Purposes	T_L	300	$^{\circ}C$

*Collector current limited by maximum Junction temperature

*Notes:

1.Pulse width limited by maximum junction temperature

Thermal Characteristic

Parameter	Symbol	Tests conditions	Min	Typ	Max	Units
Off-Characteristics						

Collector-Emmitter Voltage	BV_{CES}	$I_C=250\mu A, V_{GE}=0V$	650	-	-	V
Breakdown Voltage Temperature Coefficient	$\Delta BV_{CES}/\Delta T_J$	$I_C=0.5mA$, referenced to 25°C	-	0.6	-	V/°C
Zero Gate Voltage Collector Current	I_{CES}	$V_{CE}=650V, V_{GE}=0V, T_C=25^\circ C$	-	-	20	μA
		$V_{CE}=650V, V_{GE}=0V, T_C=175^\circ C$	-	-	2	mA
Gate-body leakage current	I_{GES}	$V_{CE}=0V, V_{GE}=\pm 20V$	-	-	± 200	nA
On-Characteristics						
Gate-Emmitter Threshold Voltage	$V_{GE(th)}$	$V_{CE}=V_{GE}, I_C=250\mu A$	4.5	-	6.5	V
Collector-Emmitter saturation Voltage	V_{CESAT}	$V_{GE}=15V, I_C=30A, T_C=25^\circ C$	-	1.75	2.1	V
		$T_C=125^\circ C$		1.95	-	
		$T_C=175^\circ C$		2.1	-	
Dynamic Characteristics						
Input capacitance	C_{ies}	$V_{CE}=25V, V_{GE}=0V, f=1.0MHz, T_C=25^\circ C$	-	1830	-	pF
Output capacitance	C_{oes}		-	160	-	pF
Reverse transfer capacitance	C_{res}		-	50.3	-	pF
Total Gate Charge	Q_g	$V_{CC}=520V, I_C=30A, R_G=7.9\Omega, V_{GE}=15V, T_C=25^\circ C$	-	64.5	-	nC
Gate to emitter charge	Q_{ge}		-	18.1	-	
Gate to collector charge	Q_{gc}		-	23.7	-	
Gate resistance	R_g	$f=1MHz$, open collector	-	1.1	-	Ω
Short current	I_{sc}	$V_{GE}=15V, V_{CE}=360V, T_{Jstart}\leq 150^\circ C, t\leq 10\mu s$	-	150	-	A
Switching Characteristics						
Turn-On delay time	$t_d(on)$	$V_{CC}=400V, I_C=30A, R_G=7.9\Omega, V_{GE}=15V, T_C=25^\circ C$	-	27.0	-	ns
Turn-On rise time	t_r		-	67.0	-	ns
Turn-off delay time	$t_d(off)$		-	67.0	-	ns
Turn-off Fall time	t_f		-	44.0	-	ns
Turn-on energy	E_{on}		-	0.83	-	mJ
Turn-off energy	E_{off}		-	0.36	-	mJ
Total switching Energy	E_{tot}		-	1.19	-	mJ
Turn-On delay time	$t_d(on)$		$V_{CC}=400V, I_C=30A, R_G$	-	27.0	-

Turn-On rise time	t_r	=7.9 Ω , $V_{GE}=15V$ $T_c=175^\circ C$	-	68.0	-	ns
Turn-off delay time	$t_d(off)$		-	90.0	-	ns
Turn-off Fall time	t_f		-	59.0	-	ns
Turn-on energy	E_{on}		-	1.09	-	mJ
Turn-off energy	E_{off}		-	0.58	-	mJ
Total switching Energy	E_{tot}		-	1.67	-	mJ
Anti-Paraller Diode Characteristics and Maximum Ratings						
Diode Forward Voltage	V_F	$V_{GE}=0V, I_F=15A.$	-	1.5	2.2	V
Diode Reverse recovery time	t_{rr}	$V_{GE}=0V,$ $V_R=400V, I_F=30A$ $di/dt=100A/us$ $T_c=25^\circ C$	-	155	-	ns
Reverse recovery charge	Q_{rr}		-	85.0	-	μC
Diode Reverse recovery Current	I_{rrm}		-	1.14	-	A
Diode Reverse recovery time	t_{rr}	$V_{GE}=0V, V_R=400V,$ $I_F=30A$ $di/dt=100A/us$ $T_c=175^\circ C$	-	307	-	ns
Reverse recovery charge	Q_{rr}		-	685	-	μC
Diode Reverse recovery Current	I_{rrm}		-	3.98	-	A
Parameter	Symbol	Value				Unit
Thermal Resistance, Junction to Case(TO-220/TO-247)	$R_{th(j-c)}$	0.77				$^\circ C/W$
Thermal Resistance, Junction to Ambient (TO-220/TO-247)	$R_{th(j-A)}$	63				$^\circ C/W$
Thermal Resistance, Junction to Case(TO-220F)	$R_{th(j-c)}$	3.2				$^\circ C/W$
Thermal Resistance, Junction to Ambient(TO-220F)	$R_{th(j-A)}$	43.2				$^\circ C/W$

Marking	Package
MSG30T65FT	TO-220
MSG30T65FS	TO-220F
MSG30T65FC	TO-247

Electrical Characteristics (curves)

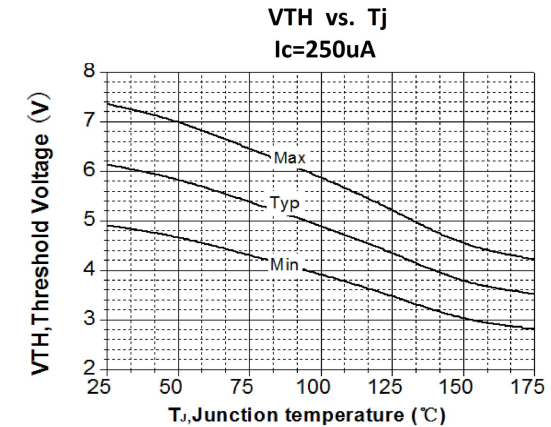
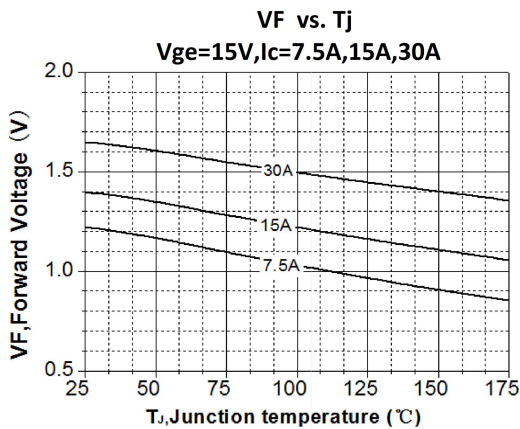
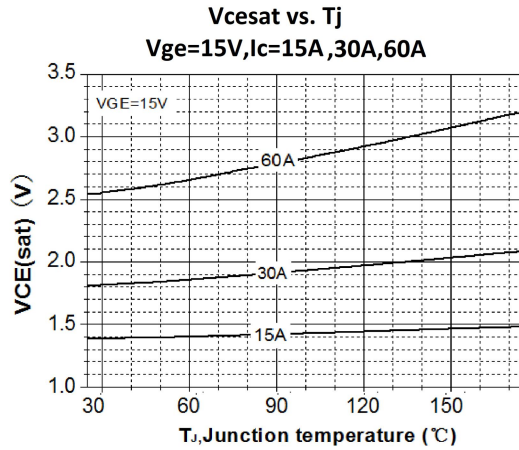
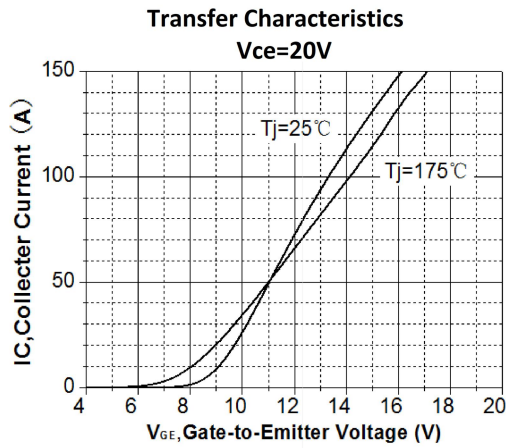
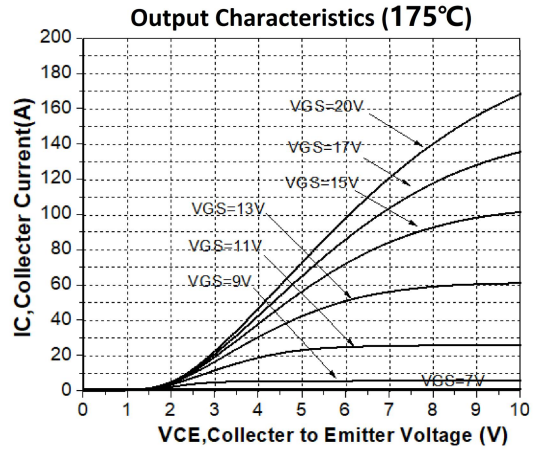
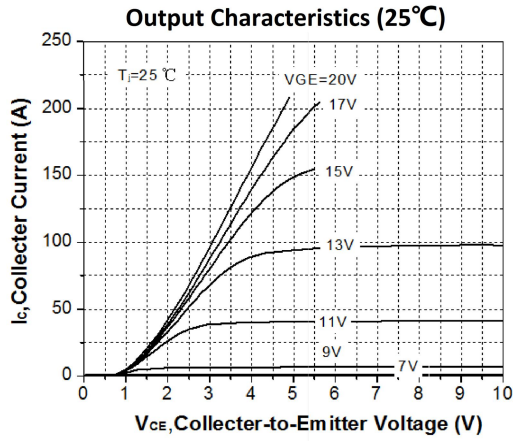

Diode Characteristics

$T_j=25^\circ\text{C}, 175^\circ\text{C}$

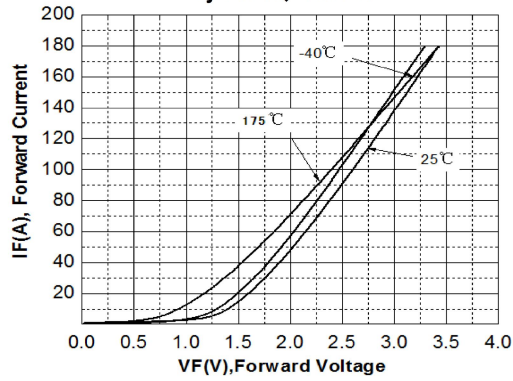

Capacitance Characteristics

$V_{ce}=25\text{V}, V_{ge}=0\text{V}, f=1\text{MHz}$

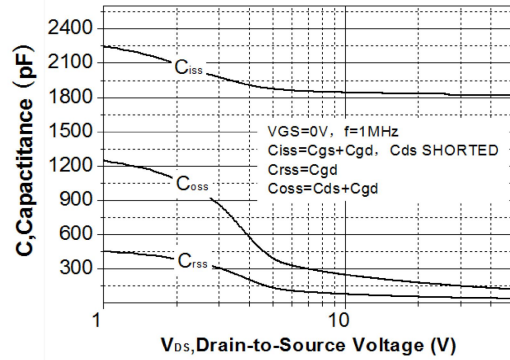

Switching Time vs. IC(25°C)

$V_{ce}=400\text{V}, V_{ge}=15\text{V}, R_G=7.9\text{ohm}$

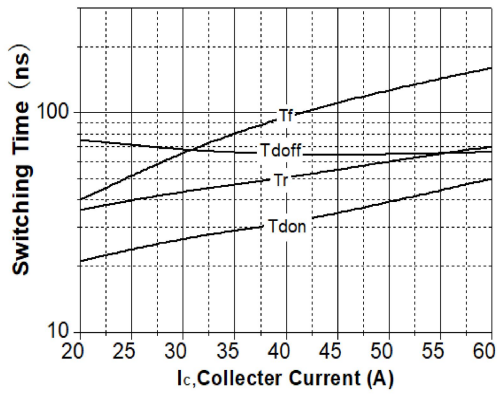

Switching Time vs. IC(175°C)

$V_{ce}=400\text{V}, V_{ge}=15\text{V}, R_G=7.9\text{ohm}$

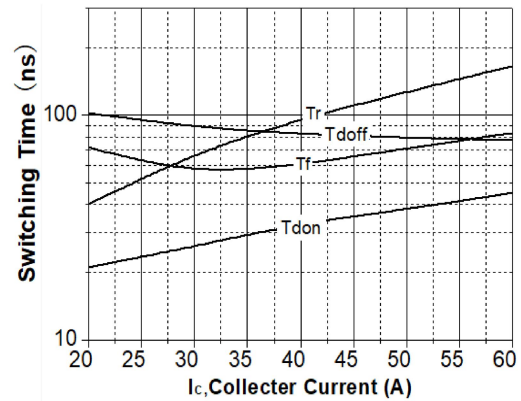

Switching Time vs. Rg(25°C)

$V_{ge}=15\text{V}, V_{ce}=400\text{V}, I_C=30\text{A}$

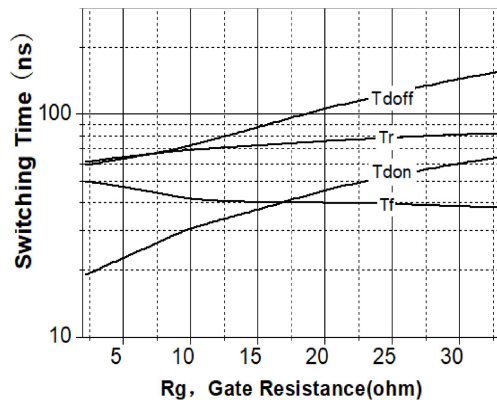

Switching Time vs. Rg(175°C)

$V_{ge}=15\text{V}, V_{ce}=400\text{V}, I_C=30\text{A}$

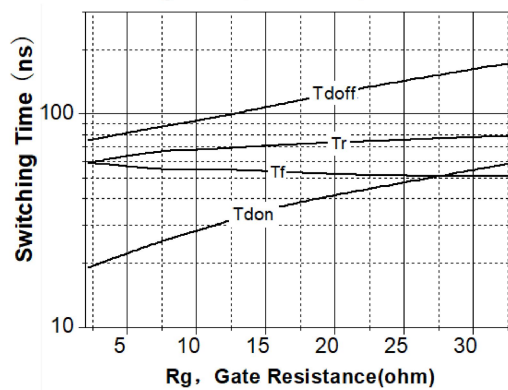

Switching Time vs. Tj
 Vge=15V, Vce=400V, IC=30A, Rg=7.9ohm

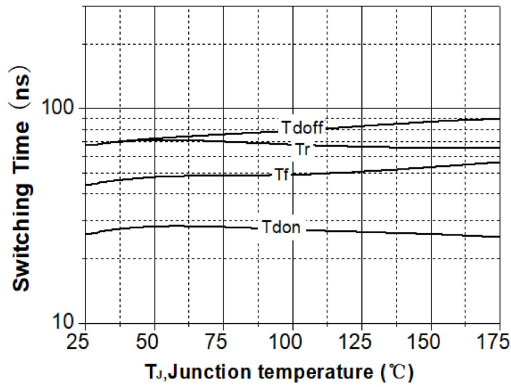

Switching Loss vs. Tj
 Vge=15V, Vce=400V, IC=30A, Rg=7.9ohm

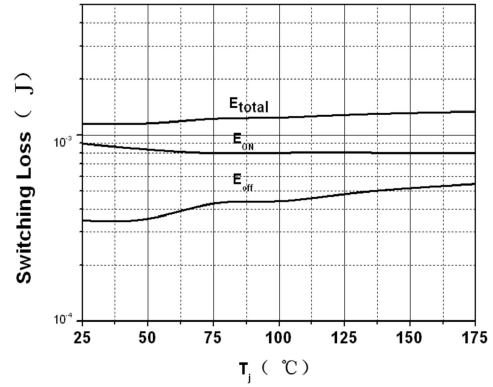

Switching Loss vs. IC(25°C)
 Vge=15V, Vce=400V, Rg=7.9ohm

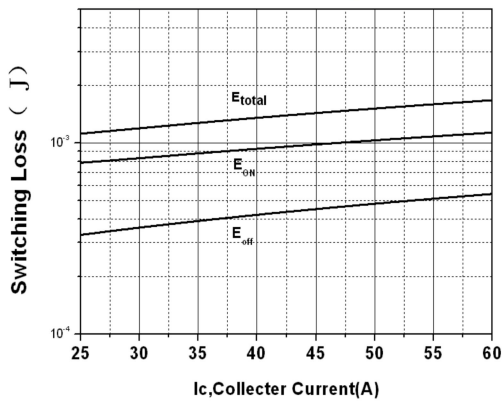

Switching Loss vs. IC(175°C)
 Vge=15V, Vce=400V, Rg=7.9ohm

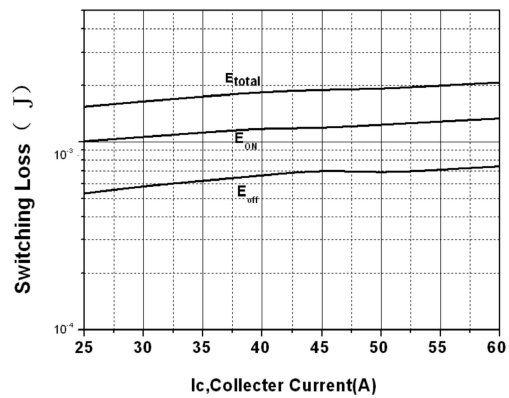

Switching Loss vs. Rg(25°C)
 Vge=15V, Vce=400V, IC=30A

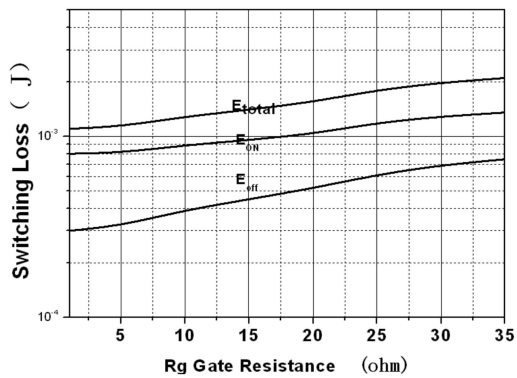

Switching Loss vs. Rg(175°C)
 Vge=15V, Vce=400V, IC=30A

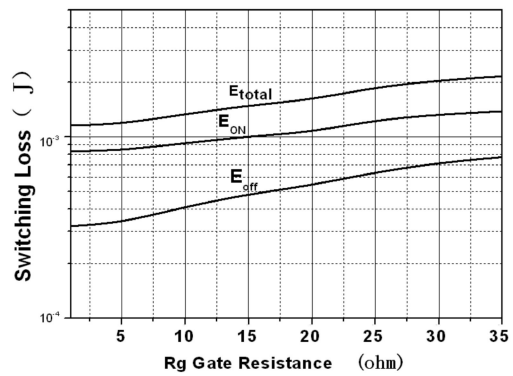

Switching Loss vs. VCE(175°C)
 $V_{ge}=15V, I_C=30A, R_g=7.9\Omega$

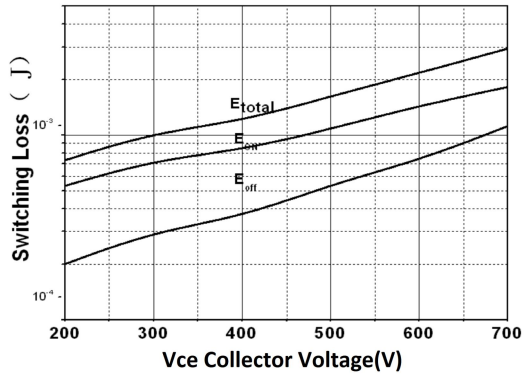

Safe Operating Area
 $T_c=25^\circ C, V_{ge}=15V$

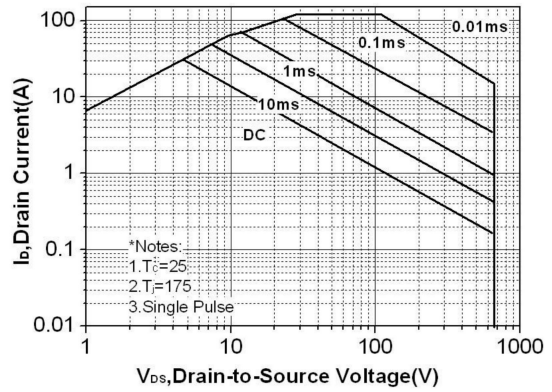

Transient Thermal Impedance

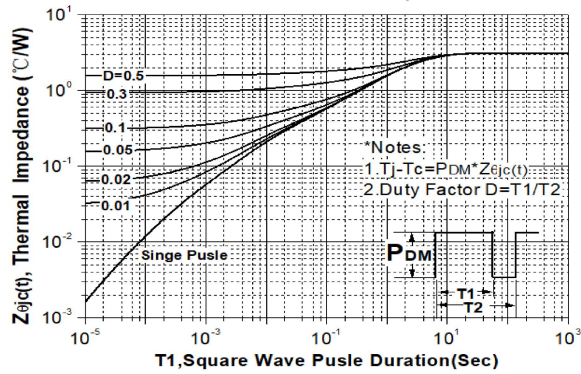

Package Mechanical DATA

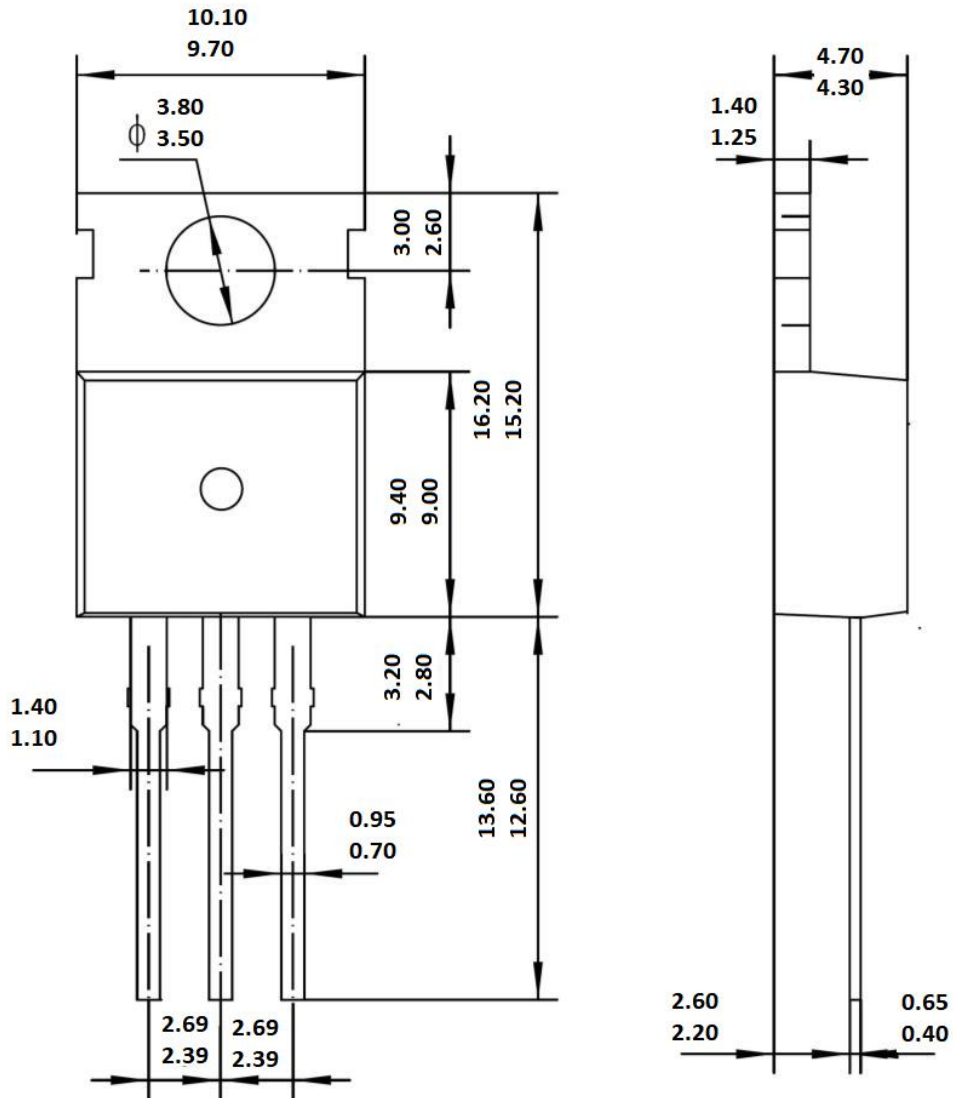

TO-220

Unit: mm

