

NO. 170217

日期

Date: 2017年02月17日

客戶
MESSRS

深圳市立创电子商务有限公司

承認書

SPECIFICATIONS FOR APPROVAL

| | | | |
|---------------|---|------------|---------|
| 制品名 | 貼片型鋁電解電容器 | | |
| PRODUCT NAME: | V-chip Aluminum Electrolytic Capacitors | | |
| 系列 | RVT Series, 105°C, ±20%, Standard | | |
| 規格 | RVT1C102M1010 | 1000UF/16V | 10*10.2 |
| | RVT1H470M0607 | 47UF/50V | 6.3*7.7 |
| | RVT1C221M0607 | 220UF/16V | 6.3*7.7 |
| | RVT1H010M0405 | 1UF/50V | 4*5.4 |
| | RVT1E221M0810 | 220UF/25 | 8*10.5 |
| | RVT1H4R7M0405 | 4.7UF/50V | 4*5.4 |
| | RVT1E220M0505 | 22UF/25V | 5*5.4 |
| | RVT1E100M0405 | 10UF/25V | 4*5.4 |
| | RVT0J470M0405 | 47UF/6.3V | 4*5.4 |
| DESCRIPTION | RVT1H100M0505 | 10UF/50V | 5*5.4 |
| | RVT1E471M1010 | 470UF/25V | 10*10.2 |
| | RVT1A102M1010 | 1000UF/10V | 10*10.2 |
| | RVT1E100M0505 | 10UF/25V | 5*5.4 |
| | RVT1C330M0505 | 33UF/16V | 5*5.4 |
| | RVT0J331M0607 | 330UF/6.3V | 6.3*7.7 |
| | RVT1C470M0605 | 47UF/16V | 6.3*5.4 |
| | RVE1C221M0607 | 220UF/16V | 6.3*7.7 |

| 客戶承認欄 APPROVAL COLUMN | 發行確認欄 APPROVED BY | |
|--------------------------|----------------------|-------------------|
| | 審核 CHECKED BY | 確認 APPROVED BY |
| | 林涛 | 张琴 |

东莞市容强电子科技有限公司

RVT 系列鋁電解電容器

Aluminum Electrolytic Capacitors

RVT SERIES

1. 範圍

Scope

適用“RVT 系列”立式片式鋁電解電容器

This specification covers “RVT Series” V-chip aluminum electrolytic capacitors.

2. 參考標準

Reference Standard

日本工業標準 JIS C-5141、JIS C-5102

Japanese industrial Standard JIS C-5141 characteristics W and JIS C-5102 except as specified in this specification.

3. 環境保護標準

Environmental Protection Standard

遵照歐盟指令 2002/95/EC.

Comply with the EU directive 2002/95/EC.

4. 使用溫度範圍

Operating Temperature Range

-55°C ~ +105°C

5. 電壓範圍

Voltage Range

4 ~ 100V

6. 容量範圍

Capacitance Range

0.1 ~ 1500 μ F

7. 容量偏差範圍

Capacitance Tolerance

$\pm 20\%$ at 120Hz, 20°C

8. 漏電流

Leakage Current

2 分鐘後讀數

$I \leq 0.01 CV$ or 3 (μ A) whichever is greater (after 2 minutes)

9. Tan δ

測試頻率: 120Hz, 溫度: 20°C

Measurement frequency: 120Hz, Temperature: 20°C

| | | | | | | | | | |
|---------------------|------|------|------|------|------|------|------|------|------|
| Rated Voltage (V) | 4 | 6.3 | 10 | 16 | 25 | 35 | 50 | 63 | 100 |
| Tan δ (max.) | 0.50 | 0.30 | 0.24 | 0.20 | 0.18 | 0.14 | 0.14 | 0.12 | 0.12 |

10. 低溫特性

測試頻率: 120Hz

Measurement frequency: 120Hz

| | | | | | | | | | | |
|----------------------------------|----------------|----|-----|----|----|----|----|----|----|-----|
| Rated Voltage (V) | | 4 | 6.3 | 10 | 16 | 25 | 35 | 50 | 63 | 100 |
| Impedance Ratio ZT/Z20 (max.) | Z-25°C /Z+20°C | 7 | 4 | 3 | 2 | 2 | 2 | 2 | 2 | 2 |
| | Z-40°C /Z+20°C | 15 | 8 | 6 | 4 | 4 | 3 | 3 | 3 | 3 |

RVT 系列鋁電解電容器

Aluminum Electrolytic Capacitors RVT SERIES

11. 耐久性

105°C施加額定電壓 2000 小時後, 電容器應滿足以下要求

After 2000 hours application of rated voltage at 105°C, capacitors meet the characteristics requirements listed.

| | |
|-----------------------------|---|
| 容量變化率 Capacitance Change | ±30%初始值內 Within ±30% of initial value |
| 損耗角正切值 Tan δ | ≤200%初始規定值 200% or less of initial specified value |
| 漏電流 Leakage Current | ≤初始規定值 Initial specified value or less |

12. 高溫儲存

105°C放置 1000 小時後, 滿足以下要求

After storage for 1000H at 105°C ±5°C

| | |
|--------------------|--|
| Capacitance Change | Within ±30% of initial value |
| Tan δ | 200% or less of initial specified value |
| Leakage Current | 300% of less of Initial specified value. |

13. 耐焊接熱

Resistance to Soldering Heat

經過回流焊後(參見第 6 頁)在溫室中恢復後, 電容器滿足以下要求

After reflow soldering according to Reflow Soldering Condition (see page 5) and restored at room temperature, they meet the characteristics listed.

| | |
|-----------------------------|---|
| 容量變化率 Capacitance Change | ≤±10%初始值 Within ±10% of initial value |
| 損耗角正切值 Tan δ | ≤初始規定值 Initial specified value or less |
| 漏電流 Leakage Current | ≤初始規定值 Initial specified value or less |

14. 標識

Marking

電容器標識內容如下:

Capacitors shall be legibly marked with the following:

1) 產品系列

Manufacture's mark

2) 額定電壓和額定電容

Rated voltage and nominal capacitance

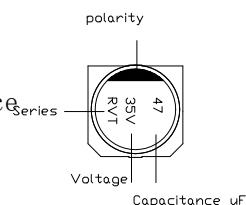

3) 負極標識
Negative polarit

RVT 系列鋁電解電容器

Aluminum Electrolytic Capacitors RVT SERIES

15. 圖樣

Drawing (Unit: mm)

($\varnothing 4 \sim \varnothing 6.3$)



* $L \pm 0.3$ (Applicable to 6.3 x 7.7)

($\varnothing 8, \varnothing 10$)



16. 尺寸

Dimensions (Unit: mm)

| $\varnothing D \times L$ | 4x5.4 | 5x5.4 | 6.3x5.4 | 6.3x7.7 | 8x6.5 | 8x10.5 | 10x10.5 | 12.5x13.5 |
|--------------------------|-------|-------|---------|---------|-------|--------|---------|-----------|
| A | 1.8 | 2.1 | 2.4 | 2.4 | 2.9 | 2.9 | 3.2 | 4.4 |
| B | 4.3 | 5.3 | 6.6 | 6.6 | 8.3 | 8.3 | 10.3 | 13.0 |
| C | 4.3 | 5.3 | 6.6 | 6.6 | 8.3 | 8.3 | 10.3 | 13.0 |
| E | 1.0 | 1.3 | 1.8 | 1.8 | 3.1 | 3.1 | 4.2 | 5.2 |
| L | 5.4 | 5.4 | 5.4 | 7.7 | 6.5 | 10.5 | 10.5 | 13.4 |

17. 編帶說明

符合標準 JIS C0806

Applicable standard JIS C0806

(RVT、RVS、RVE、RVW、RVK、RVH、RVNseries)

盒帶

17.1. 圖樣

Drawing 1 (for $\varnothing 4 \sim \varnothing 10$)



RVT 系列鋁電解電容器

Aluminum Electrolytic Capacitors

RVT SERIES

尺寸

Dimension

| Series | RVT | | | | | | | |
|----------------|-------|-------|---------|---------|-------|--------|---------|-----------|
| ∅D×L | 4×5.4 | 5×5.4 | 6.3×5.4 | 6.3×7.7 | 8×6.5 | 8×10.5 | 10×10.5 | 12.5×13.5 |
| W | 12.0 | 12.0 | 16.0 | 16.0 | 16.0 | 24.0 | 24.0 | 32.0 |
| P | 8.0 | 12.0 | 12.0 | 12.0 | 12.0 | 16.0 | 16.0 | 23.0 |
| F | 5.5 | 5.5 | 7.5 | 7.5 | 7.5 | 11.5 | 11.5 | 13.9 |
| A | 4.7 | 6.0 | 7.0 | 7.0 | 8.7 | 8.7 | 10.7 | 14.2 |
| B | 4.7 | 6.0 | 7.0 | 7.0 | 8.7 | 8.7 | 10.7 | 16.0 |
| T ₂ | 5.8 | 5.8 | 5.8 | 8.3 | 7.0 | 11.0 | 11.0 | 14.4 |

17.2. 卷盤

Reel

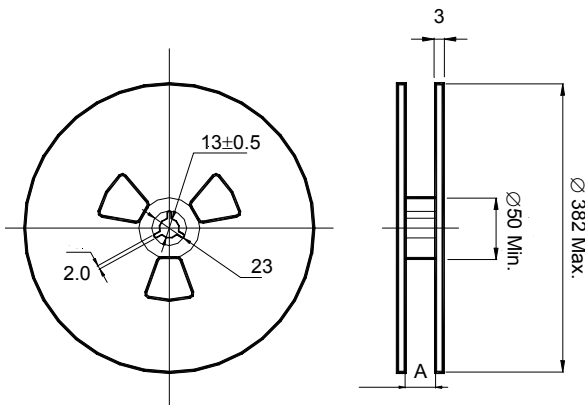

包裝數量 Package quantity

| ∅D×L | 卷裝數量 Qty./Reel | 盒裝數量 Qty./Bag |
|------------|----------------|---------------|
| 4×5.5 | 2000 pcs. | 20000 pcs. |
| 5, 6.3×5.4 | 1000 pcs. | 10000 pcs. |
| 6.3×7.7 | 1000 pcs. | 10000 pcs. |
| 8×6.5 | 1000 pcs. | 10000 pcs. |
| 8×10.5 | 500 pcs. | 5000 pcs. |
| 10×10.5 | 500 pcs. | 5000 pcs. |
| 12.5×13.5 | 200 pcs. | 1000 pcs. |

| ∅D | 4 | 5 | 6.3 | 8*6.5 | 8*10.5 | 10*10.5 | 12.5*13.5 |
|----|----|----|-----|-------|--------|---------|-----------|
| A | 14 | 14 | 18 | 18 | 26 | 26 | 32 |

18. 無鉛回流焊接

Lead-free Reflow Soldering Condition

A. 回流焊條件推薦

Recommended Conditions for Reflow Soldering

- (1) 應採用紅外線及熱風回流焊接, 不宜採用汽相加熱回流焊接;

A thermal condition system such as infrared radiation (IR) or hot blast should be adopted, and vapor heat transfer systems (VPS) are not recommended.

- (2) 推薦回流焊只進行一次, 回流焊次數如果需要二次, 必須相隔 30 分鐘以上;

Reflow soldering should be performed one time. If the capacitor has to be reflowed twice, 30 minutes must be layout between each time.

- (3) 無鉛回流焊, 請符合下述條件:

For lead-free type reflow soldering, please observe proper conditions below:

- a) 從 150°C 至 200°C 的預熱時間在 180 秒鐘以內;

The time of preheating from 150° C to 200° C shall be within maximum 180 seconds;

- b) 電容器頂部溫度超過 217°C 的焊接時間不超過 tL 秒;

The time of soldering temperature at 217° C measured on capacitors' top shall not exceed tL (second);

- c) 電容器頂部尖峰溫度不超過 Tp°C, 在 5°C 範圍內的實際尖峰溫度時間不超過 tp 秒

The peak temperature on capacitors' top shall not exceed Tp(° C), and the time within

RVT 系列铝电解电容器

Aluminum Electrolytic Capacitors RVT SERIES

5° C of actual peak temperature shall not exceed tp (second).

B. 回流焊曲线图

Classification Reflow Profile

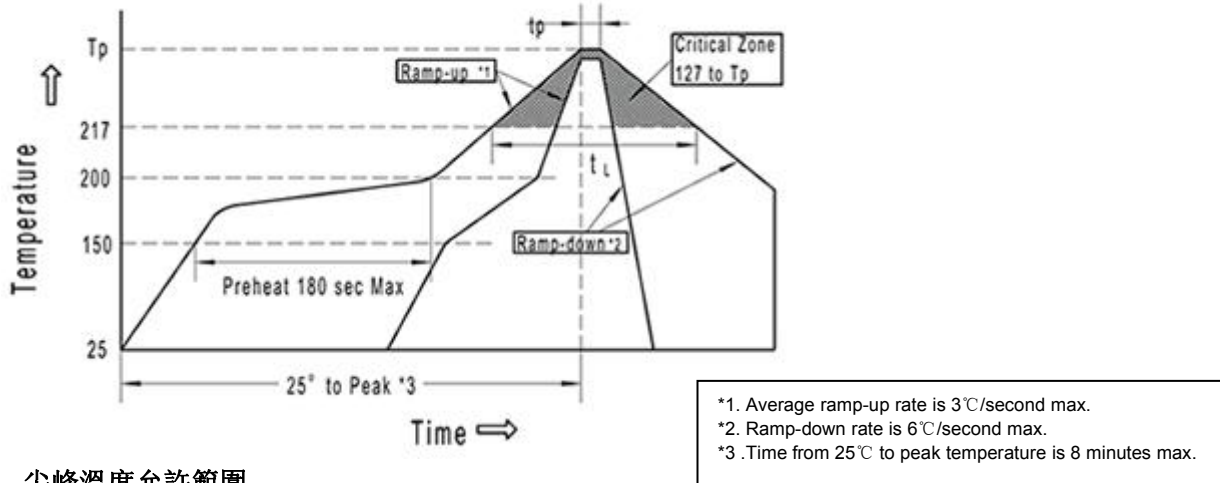

C. 尖峰温度允许范围

| Size | Thickness (mm) | Tp (° C) | tL (second) | tp (second) |
|-----------|----------------|----------|-------------|-------------|
| Ø4~Ø6.3 | ≥2.5 | 250±0 | 80 | 20 |
| Ø8 | ≥2.5 | 240±0 | 80 | 10 |
| Ø10×10.5L | ≥2.5 | 235±0 | 60 | 10 |
| 12.5*13.5 | ≥2.5 | 235±0 | 50 | 10 |

D. 表面安装推荐尺寸

Recommended Land Size (Unit: mm)

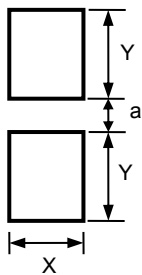

| Size | X | Y | a |
|-----------|-----|-----|-----|
| Ø4 | 1.6 | 2.6 | 1.0 |
| Ø5 | 1.6 | 3.0 | 1.4 |
| Ø6.3 | 1.6 | 3.5 | 2.1 |
| Ø8 | 2.5 | 3.5 | 3.0 |
| Ø10 | 2.5 | 4.0 | 4.0 |
| 12.5*13.5 | 2.8 | 5.3 | 5.0 |

19. 引线原材料

| Name | Material | Percentage |
|------|----------|------------|
| TPCS | Fe | 71.35% |
| | Cu | 20% |
| | Sn | 8.65% |

RVT 系列鋁電解電容器

Aluminum Electrolytic Capacitors RVT SERIES

20. 電容器代碼標志

Series (RVT) Voltage (35V) Capacitance (47 μ F) Capacitance Tolerance (\pm 20%) Case Diameter (\varnothing 6.3*7.7mm)

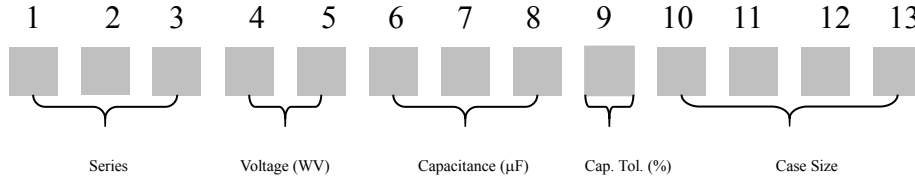

範例:

Example: **RVT** **1V** **470** **M** **0607**

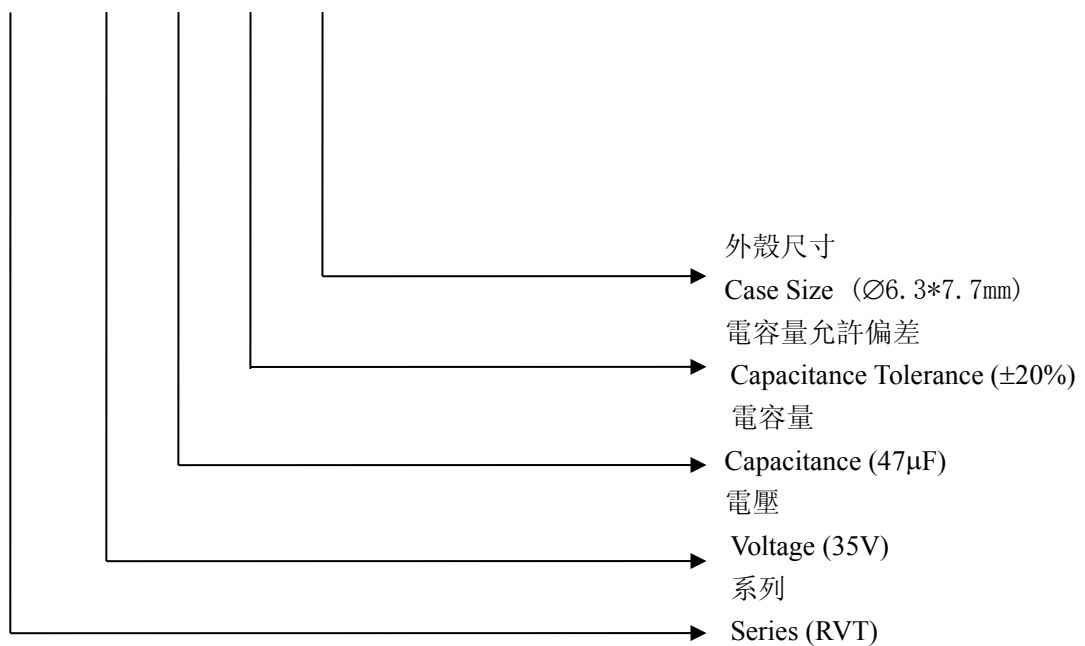

| | | | | | | | | | |
|------------------------|----|-----|----|----|----|----|----|----|-----|
| 额定电压 R.W.Voltage(V) | 4 | 6.3 | 10 | 16 | 25 | 35 | 50 | 63 | 100 |
| 代号 Code | 0G | 0J | 1A | 1C | 1E | 1V | 1H | 1J | 2A |

21. 結構

Construction

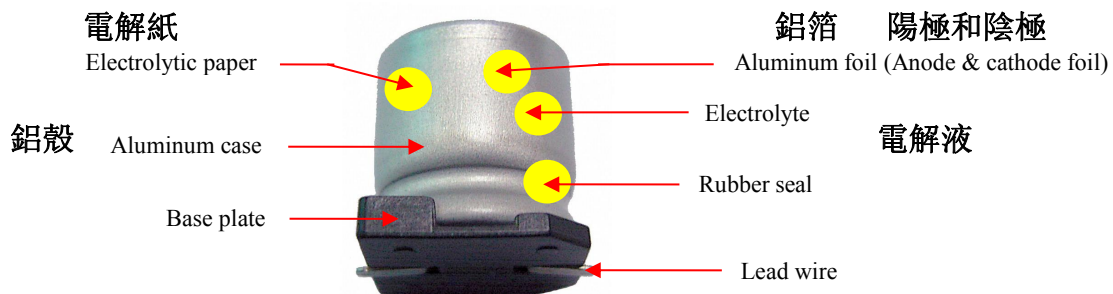

RVT 系列鋁電解電容器

Aluminum Electrolytic Capacitors RVT SERIES

22. 額定紋波電流的頻率導數

Frequency Coefficient of Allowable Ripple Current

| | | | | | |
|-------------|------|-------|-------|------|--------|
| Frequency | 50Hz | 120Hz | 300Hz | 1kHz | 10kHz~ |
| Coefficient | 0.70 | 1.00 | 1.17 | 1.36 | 1.50 |

23. 最大允許紋波電流

Dimensions & Maximum Permissible Ripple Current

| Item | RVT-P/N | Capacitance (μF) | Working Voltage (V) | Case Size (ØD×L) | Allowable ripple current (mA rms) at 105°C, 120Hz |
|------|---------------|------------------|---------------------|------------------|---|
| 1 | RVT1C102M1010 | 1000UF | 16V | 10*10.2 | 347 |
| 2 | RVT1H470M0607 | 47UF | 50V | 6.3*7.7 | 66 |
| 3 | RVT1C221M0607 | 220UF | 16V | 6.3*7.7 | 110 |
| 4 | RVT1H010M0405 | 1UF | 50V | 4*5.4 | 8.0 |
| 5 | RVT1E221M0810 | 220UF | 25V | 8*10.5 | 183 |
| 6 | RVT1H4R7M0405 | 4.7UF | 50V | 4*5.4 | 14 |
| 7 | RVT1E220M0505 | 22UF | 25V | 5*5.4 | 26 |
| 8 | RVT1E100M0405 | 10UF | 25V | 4*5.4 | 15 |
| 9 | RVT0J470M0405 | 47UF | 6.3V | 4*5.4 | 26 |
| 10 | RVT1H100M0505 | 10UF | 50V | 5*5.4 | 25 |
| 11 | RVT1E471M1010 | 470UF | 25V | 10*10.2 | 286 |
| 12 | RVT1A102M1010 | 1000UF | 10V | 10*10.2 | 320 |
| 13 | RVT1E100M0505 | 10UF | 50V | 5*5.4 | 17 |
| 14 | RVT1C470M0605 | 47UF | 16V | 6.3*5.4 | 48 |
| 15 | RVT1V471M1010 | 470UF | 35V | 10*10.2 | 286 |
| 16 | RVT1V221M0810 | 220UF | 35V | 8*10.2 | 195 |
| 17 | RVT1C100M0405 | 10UF | 16V | 4*5.4 | 17 |
| 18 | RVT1A101M0505 | 100UF | 10V | 5*5.4 | 40 |
| 19 | RVT1C470M0505 | 47UF | 16V | 5*5.4 | 33 |
| 20 | RVT1C101M0605 | 100UF | 16V | 6.3*5.4 | 63 |
| 21 | RVT1A221M0605 | 220UF | 10V | 6.3*5.4 | 110 |

4. 标称电容量、额定电压、额纹波波电流与外形尺寸参应表

Nominal capacitance, rated voltage, rated ripple current and case size table

| 电压 (V) | 6.3 (0J) | | 10 (1A) | | 16 (1C) | | 25 (1E) | |
|---------------|---------------------|-------------------------|------------------|-------------------------|------------------------------|-------------------------|---------------------|-------------------------|
| 壳号 μF | side mm | Ripple Current mA | side mm | Ripple Current mA | side mm | Ripple Current mA | side mm | Ripple Current mA |
| 22 | | | | | | | | |
| 33 | | | | | | | | |
| 47 | | | | | | | | |
| 100 | | | | | | | 6.3x7.7 8x6.2 | 91 105 |
| 220 | 6.3x7.7 | 105 | 6.3x7.7 8x6.2 | 105 120 | 8x10.2 8x6.2 (6.3x7.7) | 150 125 (105) | 8x10.2 10x10.2 | 175 199 |
| 330 | 6.3x7.7 8x6.2 | 105 120 | 8x10.2 | 196 | 8x10.2 | 195 | 10x10.2 (8x10.2) | 240 (220) |
| 470 | 8x10.2 6.3x7.7 | 210 162 | 8x10.2 | 210 | 10x10.2 (8x10.2) | 295 (230) | 10x10.2 | 280 |
| 1000 | 10x10.2 (8x10.2) | 300 (230) | 10x10.2 | 315 | 10x10.2 | 340 | 12.5x13.5 | 700 |
| 1500 | 10x10.2 | 315 | | | | | | |

| 电压 (V) | 35 (1V) | | 50 (1H) | | 63 (1J) | | 100 (2A) | |
|---------------|----------------------|-------------------------|---------------------|-------------------------|---------------------|-------------------------|---------------------|-------------------------|
| 壳号 μF | side mm | Ripple Current mA | side mm | Ripple Current mA | side mm | Ripple Current mA | side mm | Ripple Current mA |
| 4.7 | | | | | | | 6.3x7.7 | 35 |
| 10 | | | | | 6.3x7.7 | 39 | 8x10.2 (6.3x7.7) | 77 (35) |
| 22 | | | 6.3x7.7 | 51 | 8x10.2 (6.3x7.7) | 98 (49) | 10x10.2 (8x10.2) | 126 (84) |
| 33 | | | 6.3x7.7 | 60 | 8x10.2 | 112 | 10x10.2 | 133 |
| 47 | 6.3x7.7 8x6.2 | 70 78 | 8x10.2 (6.3x7.7) | 120 (63) | 10x10.2 (8x10.2) | 160 (119) | 10x10.2 | 140 |
| 100 | 6.3x7.7 (10x10.2) | 84 (136) | 10x10.2 (8x10.2) | 170 (140) | 10x10.2 | 196 | | |
| 150 | 8x10.2 | 155 | | | | | | |
| 220 | 10x10.2 (8x10.2) | 220 (190) | 10x10.2 | 220 | | | | |
| 330 | 10x10.2 | 245 | 12.5*13.5 | 490 | | | | |
| 470 | 10x10.2 | 280 | 12.5*13.5 | 550 | | | | |

RVT 系列鋁電解電容器

Aluminum Electrolytic Capacitors RVT SERIES

25. 片式鋁電解電容器一般使用注意事項

Application guideline for V-CHIP aluminum electrolytic capacitors

A) 電路設計

Circuit Design

1) 充分考慮電容器使用和安裝條件在容仕產品目錄的規定範圍內

Please make sure the environmental and mounting conditions to which the capacitor will be exposed are within the conditions specified in RJ' s catalogue.

2) 工作溫度和施加的紋波電流應在容仕產品目錄的規定範圍內

Operating temperature and applied ripple shall be within RJ specification.

3) 在設計電路時，應選擇符合壽命要求的產品

Appropriate capacitors which comply with the life requirement of the products should be selected when designing the circuit.

4) 鋁電解電容器是有極性的，不應加反向電壓或交流電壓。對可能出現反向電壓的電路，應選擇雙極性電容器。注意：即使雙極性電容器，也不能直接用於純交流電路

Aluminum electrolytic capacitors are polar. Make sure that no reverse voltage or AC voltage is applied to the capacitors. Please use bi-polar capacitors for a circuit that can possibly see reversed polarity.

Note: Even bi-polar capacitors cannot be used for AC voltage application.

5) 對需要快速和頻繁充放電的電路，不應使用鋁電解電容器，而應選擇特別設計的具有長壽命的電容器

Do not use aluminum electrolytic capacitors in a circuit that requires rapid and very frequent charge / discharge.

In this type of circuit, it is necessary to use a special design capacitor with extended life characteristics.

6) 不應使用過載電壓

Do not apply excess voltage.

① 直流電壓與紋波電壓疊加後的峰值電壓不應超過額定工作電壓

Please pay attention to that the peak voltage, which is DC voltage overlapped by ripple current, will not exceed the rated voltage.

- ② 若 2 個以上電容器串聯，應確保施加電壓低於額定值，而且要並聯一個平衡電阻，以使每個電容器所加電壓相等。

In the case where more than 2 aluminum electrolytic capacitors are used in series, please make sure that applied voltage will be lower than rated voltage and the voltage will be applied to each capacitor equally by using a balancing resistor in parallel with the capacitor

7) 電容器不能應用於下述環境條件下:

Aluminum electrolytic capacitors shall not be used under the following environmental conditions:

- ①(a) 電容器被暴露於水（包括濃縮液）、鹽水或油中。

Capacitors will be exposed to water (including condensation), brine or oil.

- (b) 周圍環境中有氫化硫、亞硫酸、亞硝酸、氯氣、溴氣、溴化甲烷、氨氣等有毒氣體。

Ambient conditions that include toxic gases such as hydrogen sulfide, sulfurous acid, nitrous acid, chlorine, bromine, methyl bromide, ammonium, etc.

RVT 系列鋁電解電容器

Aluminum Electrolytic Capacitors RVT SERIES

- (c) 周圍環境中有臭氧、紫外線及輻射。

Ambient conditions that expose the capacitor to ozone, ultraviolet ray and radiation.

- ② 嚴重的振動及機械沖擊超過容仕產品目錄的規定範圍。

Severe vibration and physical shock conditions that exceed RJ specification.

振動的測試條件如下

Vibration test condition:

振動頻率範圍 : 10-55-10Hz

vibration frequency range : 10~55~10Hz

掃描頻率 : 10-55-10Hz/分鐘

sweep rate : 10~55~10Hz/minute

掃描方式 : 對數

sweep method : logarithmic

振幅或加速度 : 1.5mm (最大加速度為 10G)

amplitude or acceleration : 1.5mm (max. acceleration is 10G)

振動方向 : X、Y、Z 方向

direction of vibration : X, Y, Z direction

測試時間 : 每個方向 2 小時

testing time : 2 hours per each direction

沖擊一般不適用。

Shock is not applicable normally.

如有特殊要求，請與我們銷售部門聯繫。

If a particular condition is required, please contact our sales office.

- 8) 電解液主要化學溶劑及電解紙為易燃物，且電解液導電。當電解液與 PC 板接觸時，可能會腐蝕 PC 板上的線路，或造成短路，以致產生煙或著火。因此在電容器封口下端不應有任何線路。

The main chemical solution of the electrolyte and the separator paper used in the capacitors are combustible. The electrolyte is conductive. When it comes in contact with the PC board, there is a possibility of pattern corrosion or short circuit between the circuit pattern, which could result in smoking or catching fire. Do not locate any circuit pattern beneath the capacitor end seal.

- 9) 設計線路板時應確保發熱元器件不靠近鋁電解電容器或 PC 板的另一面，避免其正好在電容器的下面。

Do not design a circuit board that the heat generating components are placed near the aluminum electrolytic capacitor or on the reverse side of PC board, if that just under the capacitor.

- 10) 設計線路板時應考慮到電容器的電性能可能隨溫度和頻率的變化而變化。
Electrical characteristics may vary depending on changes in temperature and frequency. Please consider this variation when you design circuits.
- 11) 當 2 個以上電容器並聯時, 應考慮到通過這些電容器的電流平衡。
When you install more than 2 capacitors in parallel, please consider the balance of current flowing into the capacitors.
- 12) 在雙面線路板上安裝電容器時, 電容器的安裝位置應避開多餘的基板孔和過孔。
While mounting capacitors on double-side PC board, the capacitors should be away from those unnecessary base plate holes and connection holes.

B) 安裝

Mounting

- 1) 一旦電容器經過安裝及加載, 不要再試圖用於其他線路板或其他用途。
Once a capacitor has been assembled in the set and power applied, do not attempt to re-use the capacitor in other circuits or application.
- 2) 貯存超過 2 年的電容器, 其漏電流可能增大。若漏電流增大, 請使用 1K Ω 電阻做充電處理。

RVT 系列鋁電解電容器

Aluminum Electrolytic Capacitors RVT SERIES

Leakage current of the capacitors that have been stored for more than 2 years may increase. When leakage current has increased, please perform a voltage treatment using a 1k Ω resistor.

- 3) 在將電容器安裝在 PC 板之前, 請確認其規格和極性。
Please confirm specifications and polarity before installing capacitors on the PC board.
- 4) 不要將電容器掉在地上, 或不要使用掉在地上的電容器。
Do not drop capacitors on the floor, nor use a capacitor that was dropped.
- 5) 安裝時請不要損傷電容器。
Do not deform the capacitor during installation.
- 6) 請注意貼片機的吸頭、產品檢測夾具或對中裝置對電容器的機械沖擊。
Please pay attention to the mechanical shock to the capacitor by suction nozzle of the automatic insertion machine or automatic mounter, or by product checker, or by centering mechanism.
- 7) 回流焊 Reflow soldering
 - ① 請遵守容仕產品目錄中的回流焊條件。
Please follow "Reflow Soldering Conditions" in RJ' s catalogue.
 - ② 當使用紅外線加熱時, 請注意加熱程度, 因為紅外線吸收率會隨著電容器顏色和大小的不同而改變。
When an infrared heater is used, please pay attention to the extent of heating since the absorption rate of infrared will vary due to difference in the color and size of the capacitor.
- 8) 將電容器焊接在 PC 板後, 不要傾斜或扭動電容器。
Do not tilt lay down or twist the capacitor body after the capacitor are soldered to the PC board.
- 9) 不要抓住焊接後的電容器搬動 PC 板。
Do not carry the PC board by grasping the soldered capacitor.
- 10) 不要讓任何物品接觸焊接後的電容器。如果 PC 板堆放儲存, 請確保 PC 板或其他零部件不觸到電容器。
Please do not allow anything to touch the capacitor after soldering. If PC boards are stored in stack, please make sure the PC board or other components away from the capacitor.
- 11) 焊接後的電容器不應受到任何已焊接 PC 板或其他元器件熱輻射的影響。
The capacitors shall not be effected by any radiated heat from the soldered PC board or other components after soldering.
- 12) 清洗: Cleaning
 - ① 不能用鹵化清洗劑清洗電容器。如必須使用鹵化清洗劑, 請與我們銷售部門聯系。
Do not clean capacitors with halogenated cleaning agent. However, if it is necessary to clean with halogenated cleaning agent, please contact our sales office.

②推薦清洗方法:

Recommended cleaning method

使用範圍: 任何類型及規格

Applicable: Any type, any ratings

清洗方法: 浸泡、超聲波或其他方法的總清洗時間應在 2 分鐘內。清洗劑溫度應在 40°C 以下。清洗後, 應將電容器與 PC 板一起用熱風吹至少 10 分鐘。熱風溫度應低於電容器工作溫度。水洗後若不充分吹幹, 可能導致外觀不良, 如座板發脹等。

Cleaning conditions : Total cleaning time shall be within 2 minutes by immersion, ultrasonic or other methods. Temperature of the cleaning agents shall be 40°C or below. After cleaning, capacitors should be dried by using hot air for the minimum 10 minutes along with the PC board mounted. Hot air temperature should be within the maximum operating temperature of the capacitor. Insufficient dryness after water rinse may cause appearance problems, such as bottom-plate bulge and etc.

RVT 系列鋁電解電容器

Aluminum Electrolytic Capacitors RVT SERIES

③ 避免使用破壞臭氧層的清洗劑以保護環境。

Avoid using ozone destructive substances as cleaning agents for protecting global environment.

C) 安裝後 In the Equipment

1) 不要直接用手接觸電容器正負極。

Do not directly touch terminal by hand.

2) 不要在正負極之間用導體連接, 也不要將電容器及其附近濺散導電液體, 如酸鹼溶液等。

Do not link positive terminal and negative terminal by conductor, nor spill conductible liquid such as alkaline or acidic solution on or near the capacitor.

3) 在使用環境中應避免濺上水或油, 避免陽光直射、紫外線照射、輻射、有毒氣體、振動或機械沖擊。

Please make sure that the ambient conditions where the set is installed are free from spilling water or oil, direct sunlight, ultraviolet rays, radiation, poisonous gases, vibration or mechanical shock.

D) 維護和檢驗 Maintenance and Inspection

請定期檢測安裝在工業設備上的電容器。檢測項目如下:

Please periodically inspect the aluminum capacitors that are installed in industrial equipment. The following items should be checked:

外觀: 明顯缺陷, 如防爆閥打開、電解液泄露等。

Appearance: remarkable abnormality such as pressure relief vent opening, electrolyte leaking, etc.

電性能: 電容量、損耗角正切、漏電流等, 具體數據參見容仕產品目錄和相關產品規格書。

Electrical characteristics: capacitance, dielectric loss tangent, leakage current and etc., which are specified in RJ' s catalogue or alternate product specification.

E) 緊急情況

In an Emergency

- 1) 若看見因防爆閥動作而產生的煙氣, 請關閉主開關或拔開離合器。

If you see smoke due to operation of safety vent, please turn off the main switch or pull out the plug from the outlet.

- 2) 若吸入氣體或咽下電解液, 應立即用水清洗口腔和喉嚨。

If you breathe the gas or ingest the electrolyte, please wash out your mouth and throat with water immediately.

- 3) 若皮膚沾上電解液, 請用肥皂和水清洗幹淨。

If your skin is exposed to the electrolyte, please wash it away using soap and water.

F) 儲存

Storage

- 1) 不要將電容器儲存在溫度和濕度高的地方。

儲存環境應為溫度: 5°C-35°C, 相對濕度: <75%, 儲存地點: 室內。

Do not keep capacitor in high temperature and high humidity atmosphere.

Storage conditions should be:

RVT 系列鋁電解電容器

Aluminum Electrolytic Capacitors RVT SERIES

Temperature: 5°C~35°C

Humidity : lower than 75%

Place : Indoor

- 2) 避免電容器的儲存環境中有水、鹽水或油。

Avoid ambient conditions where capacitors are covered with water, brine or oil.

- 4) 避免電容器暴露在臭氧、紫外線或輻射中。

Avoid ambient conditions where capacitors are exposed to ozone, ultraviolet ray or radiation.

G) 處置

Disposal

請用下面任何一種方法處置電容器:

Please take either of the following methods in disposing capacitors.

- 1) 在電容器殼體上開孔或將電容器壓碎後焚燒。

Incinerate them after crushing capacitors or making a hole on the capacitor body.

- 2) 如不能進行焚燒, 請交給廢物處理機構進行填埋。

If incineration is not applicable, hand them over to a waste disposal agent and have them buried in landfills.