

CDBHM120L-HF Thru. CDBHM1100L-HF

Reverse Voltage: 20 to 100 Volts

Forward Current: 1.0 Amp

RoHS Device

Halogen Free

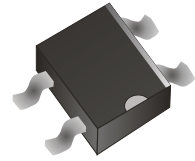

Features

- High surge forward current capability.
- Low Forward voltage drop.
- General purpose 1 phase Bridge rectifier applications
- UL recognized file # E230084

Mechanical data

- Case: molded plastic
- Epoxy: UL 94V-0 rate flame retardant.
- Lead: solder plated
- Polarity: As marked
- Weight: 0.125 gram(approx)

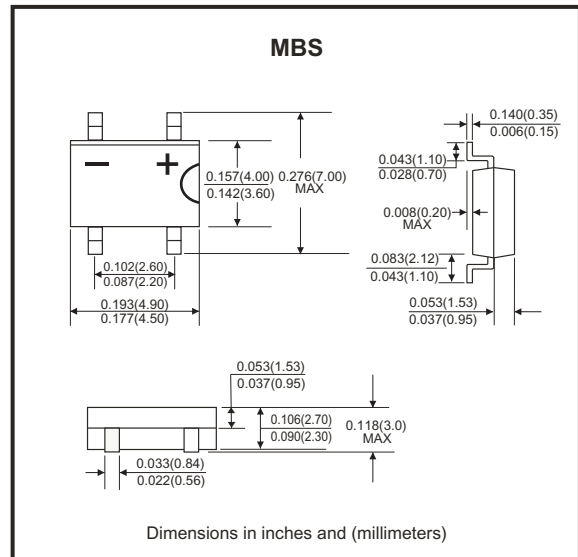

Maximum Ratings and Electrical Characteristics

Rating at 25°C ambient temperature unless otherwise specified.
Single phase, half wave, 60Hz resistive or inductive load.
For capacitive load, derate current by 20%

Parameter	Symbol	Conditions	CDBHM-HF					Units
			120L	140L	160L	180L	1100L	
Max. Repetitive peak reverse voltage	V_{RRM}		20	40	60	80	100	V
Max. DC blocking voltage	V_{DC}		20	40	60	80	100	V
Max. RMS voltage	V_{RMS}		14	28	42	56	70	V
Average rectified output current @60Hz sine wave, R-load, $T_A=25^\circ\text{C}$	I_o	On alumina substrate	1.0					A
		On glass-epoxi substrate	0.8					
Peak forward surge current, 8.3ms single half sine-wave superimposed on rated load (JEDEC method)	I_{FSM}		40					A
Max. Peak forward voltage	V_{FM}	$I_{FM}=0.5\text{A}$	0.55	0.65	0.85			V
Max. Peak reverse current	I_{RRM}	$V_{RM}=V_{RRM}$	0.5					mA
Max. Current Squared Time	I^2t	$1\text{ms} \leq t < 8.3\text{ms}$ $T_A=25^\circ\text{C}$	6.6					A^2S
Max. Thermal resistance	$R_{\theta JA}^{(1)}$	On alumina substrate	76					$^\circ\text{C/W}$
		On glass-epoxi substrate	134					
	$R_{\theta JL}$	Between junction and lead	20					
Operating temperature range	T_J		-55 to +150					$^\circ\text{C}$
Storage temperature range	T_{STG}		-55 to +150					$^\circ\text{C}$

Notes: 1. Between junction and ambient

Company reserves the right to improve product design , functions and reliability without notice.

REV: D

Rating and Characteristics Curves (CDBHM120L-HF Thru. CDBHM1100L-HF)

Fig.1 - Forward Current Derating Curve

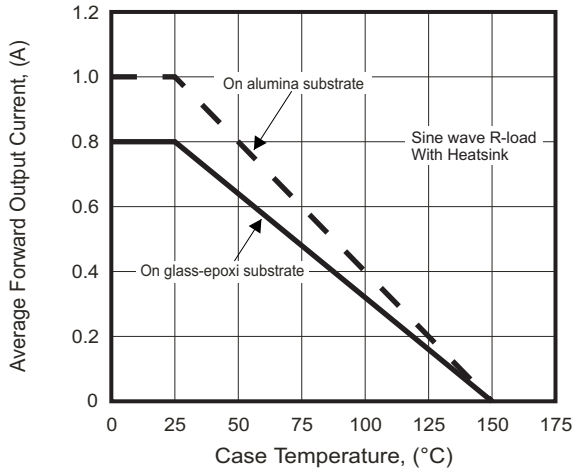

Fig.2 - Typical Forward Characteristics

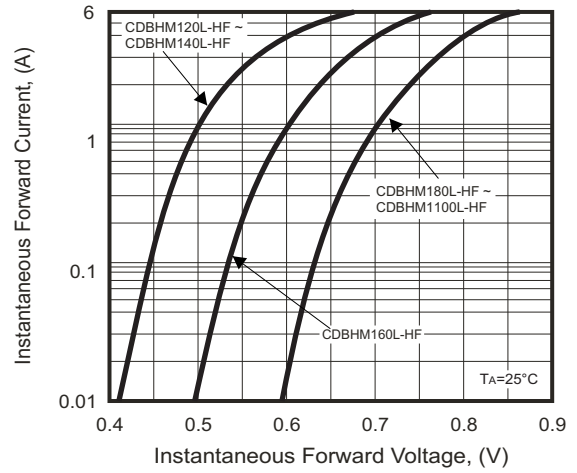

Fig.3 - Maximum Non-Repetitive Surge Current

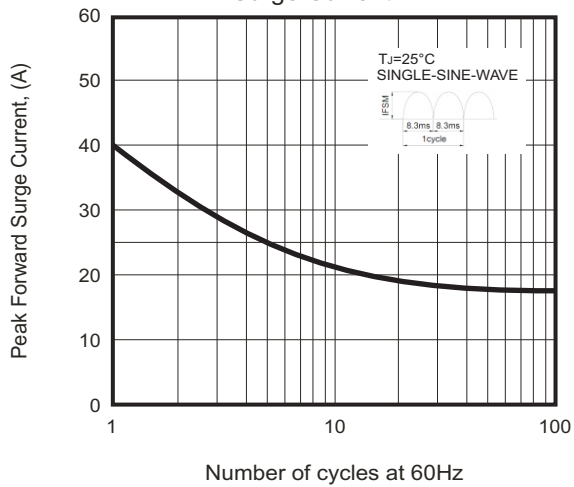
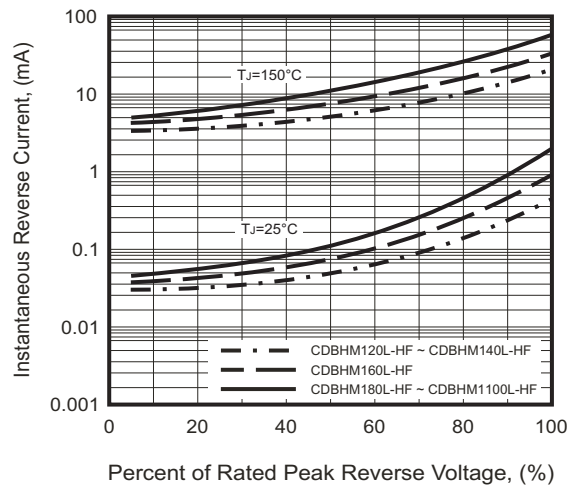
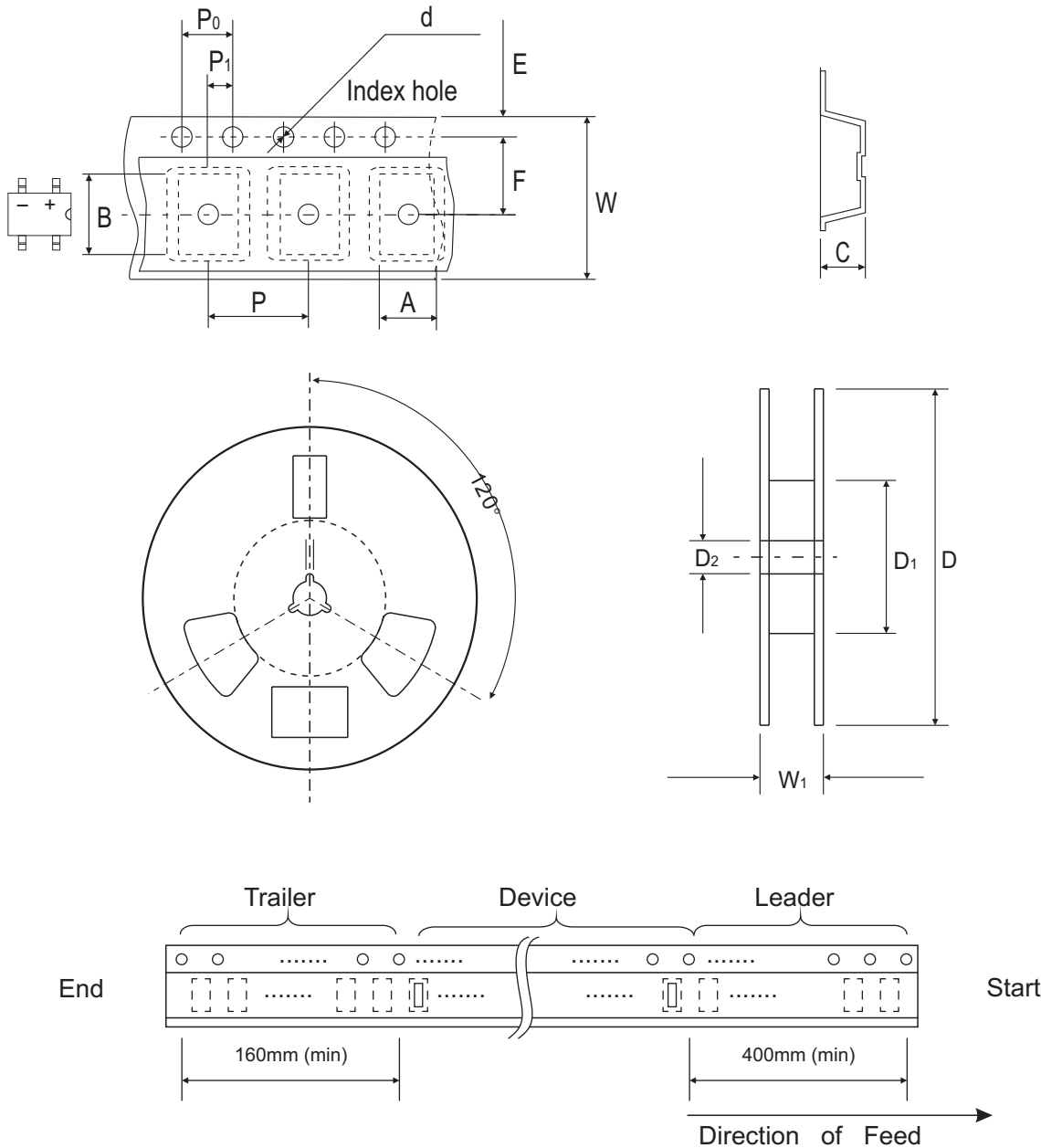

Fig.4 - Typical Reverse Characteristics



Reel Taping Specification



MBS	SYMBOL	A	B	C	d	D	D1	D2
	(mm)	5.00 ± 0.10	7.24 ± 0.10	2.95 ± 0.10	1.55 ± 0.05	330.0 ± 2.00	50.0 Min.	13.0 ± 0.50
	(inch)	0.197 ± 0.004	0.285 ± 0.004	0.116 ± 0.004	0.061 ± 0.002	13.00 ± 0.079	1.969 Min.	0.512 ± 0.020

MBS	SYMBOL	E	F	P	P0	P1	W	W1
	(mm)	1.75 ± 0.10	5.50 ± 0.05	8.00 ± 0.10	4.00 ± 0.10	2.00 ± 0.10	12.00 ± 0.30	18.70 Max.
	(inch)	0.069 ± 0.004	0.217 ± 0.002	0.315 ± 0.004	0.157 ± 0.004	0.079 ± 0.004	0.472 ± 0.012	0.736 Max.

Company reserves the right to improve product design, functions and reliability without notice.

REV: D

Marking Code

Part Number	Marking Code
CDBHM120L-HF	MBSK12SE
CDBHM140L-HF	MBSK14SE
CDBHM160L-HF	MBSK16SE
CDBHM180L-HF	MBSK18SE
CDBHM1100L-HF	MBSK110SE

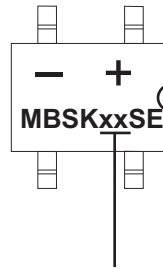

xx/xxx = Product type marking code

Suggested PAD Layout

SIZE	MBS	
	(mm)	(inch)
A	1.20	0.047
B	1.84	0.072
C	2.40	0.094
D	6.00	0.236

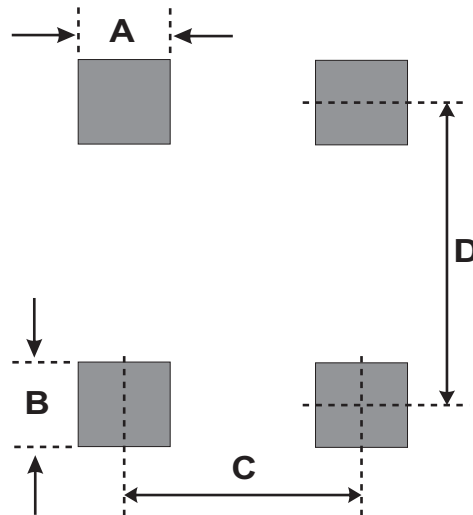

Standard Packaging

Case Type	REEL PACK	
	REEL (pcs)	Reel Size (inch)
MBS	2,500	13

Mouser Electronics

Authorized Distributor

Click to View Pricing, Inventory, Delivery & Lifecycle Information:

[Comchip Technology:](#)

[CDBHM1100L-HF](#) [CDBHM140L-HF](#) [CDBHM160L-HF](#) [CDBHM180L-HF](#) [CDBHM120L-HF](#)