

## CDBHD240-HF Thru. CDBHD2100-HF

Reverse Voltage: 40 to 100 V

Forward Current: 2.0 A

RoHS Device  
Halogen Free

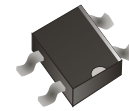

### Features

- Schottky brier chip.
- Low power loss, high efficiency.
- ideally suited for automatic assembly.
- Surge overload rating to 50A peak.
- Plastic case material has UL flammability classification 94V-0.

### Mechanical data

- Case: MBS, molded plastic.
- Terminals: Plated leads solderable per MIL-STD-202, method 208.
- Polarity: As marked on body.
- Mounting position: Any.

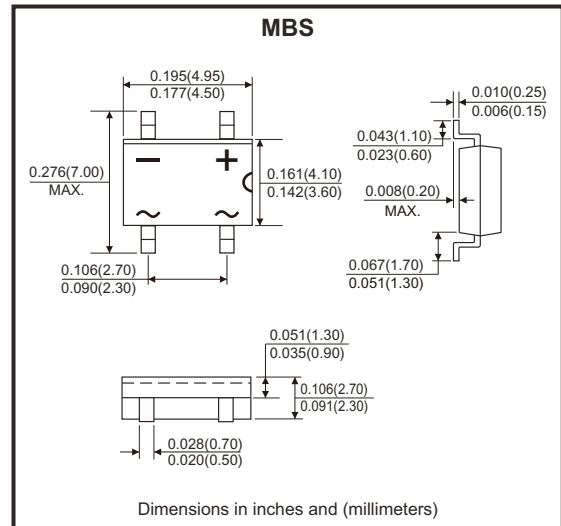

### Circuit Diagram

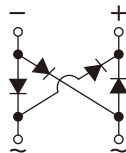

### Maximum Ratings and Electrical Characteristics (at $T_A=25^\circ\text{C}$ , unless otherwise specified)

Single phase, half wave, 60Hz, resistive or inductive load. For capacitive load, derate current by 20%.

Parameter	Symbol	CDBHD240-HF	CDBHD260-HF	CDBHD2100-HF	Unit
Peak repetitive reverse voltage	$V_{RRM}$	40	60	100	V
RMS reverse voltage	$V_{RMS}$	28	42	70	V
DC blocking voltage	$V_{DC}$	40	60	100	V
Average rectified output current (Note 1) @ $T_c=100^\circ\text{C}$	$I_{F(AV)}$	2			A
Non-repetitive peak forward surge current 8.3ms single has sine-wave superimposed on rated load (JEDEC method)	$I_{FSM}$	50			A
$I^2t$ rating for fusing ( $t < 8.3\text{ms}$ )	$I^2t$	10.375			$\text{A}^2\text{s}$
Forward voltage per element @ $I_F=2\text{A}$	$V_{FM}$	0.5	0.7	0.85	V
Peak reverse current @ $T_A=25^\circ\text{C}$ at rated DC blocking voltage @ $T_A=100^\circ\text{C}$	$I_{RM}$	0.1 10		0.05 5	mA
Typical junction capacitance per leg (Note 3)	$C_J$	200			pF
Typical thermal resistance per leg (Note 2)	$R_{\theta JL}$	16			$^\circ\text{C}/\text{W}$
Operating junction temperature range	$T_J$	-55 to +150			$^\circ\text{C}$
Operating and storage temperature range	$T_{STG}$	-55 to +150			$^\circ\text{C}$

Notes: 1. Mounted on aluminum substrate PC board with  $1.3\text{mm}^2$  solder pad.

2. Thermal resistance from junction to lead.

3.  $f=1\text{MHz}$  and applied 4V DC reverse voltage.

## Rating and Characteristics Curves (CDBHD240-HF Thru. CDBHD2100-HF)

Fig.1 - Forward Current Derating Curve

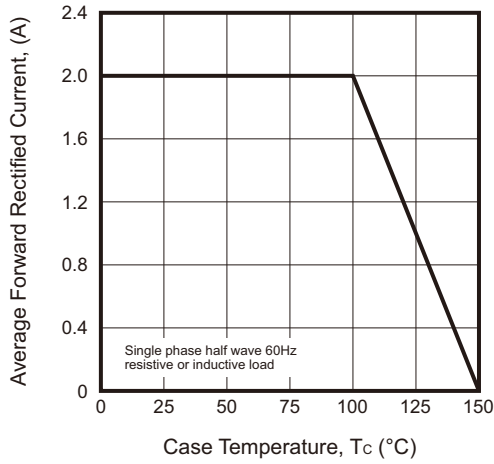

Fig.2 - Maximum Non-Repetitive Peak Forward surge current

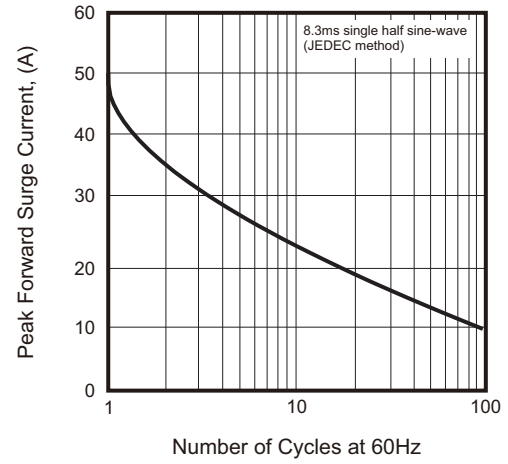

Fig.3 - Typical Instantaneous Forward Characteristics

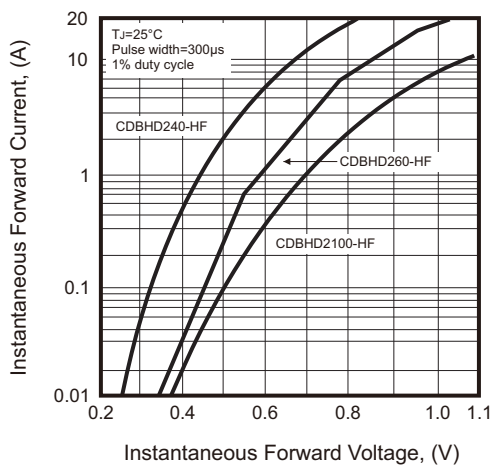

Fig.4 - Typical Reverse Characteristics

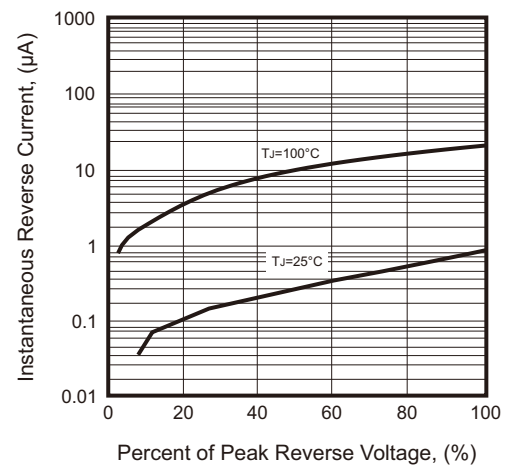
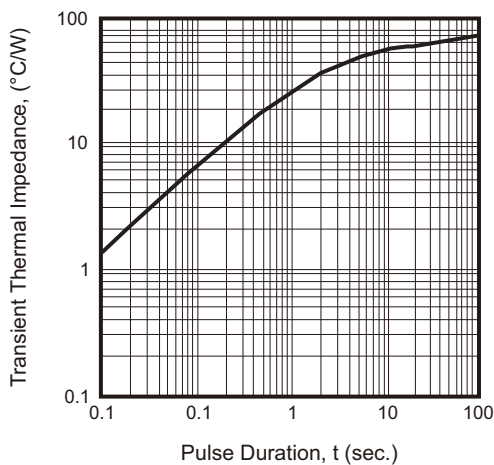
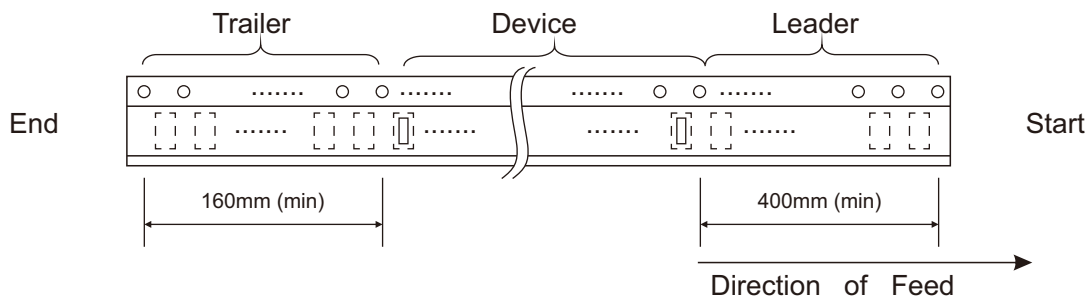
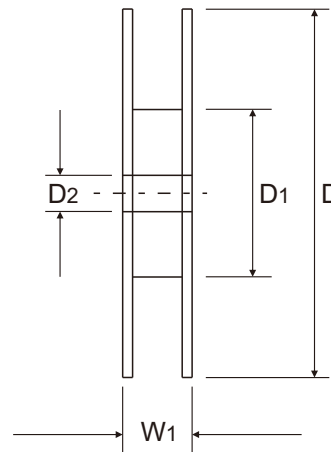
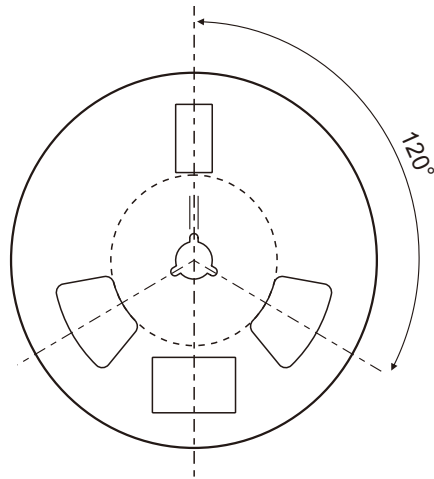
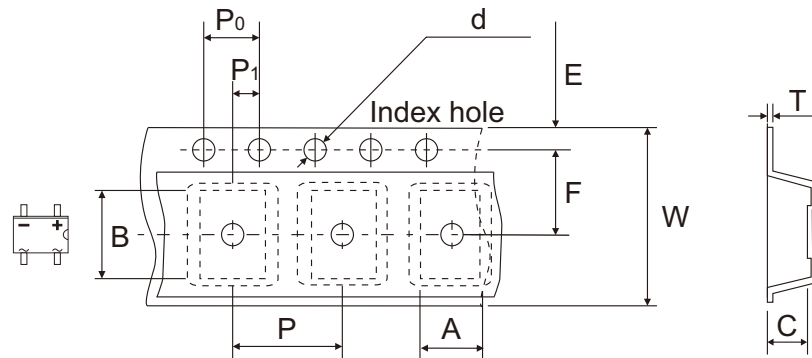

Fig.5 - Typical Transient Thermal Impedance



## Reel Taping Specification



MBS	SYMBOL	A	B	C	d	D	D1	D2
	(mm)	4.90 ± 0.10	7.22 ± 0.10	2.88 ± 0.10	1.55 ± 0.05	330 ± 1.00	100 ± 0.50	13.00 + 0.50
	(inch)	0.193 ± 0.004	0.284 ± 0.004	0.113 ± 0.004	0.061 ± 0.002	12.992 ± 0.039	3.937 ± 0.020	0.512 + 0.020

MBS	SYMBOL	E	F	P	P0	P1	T	W	W1
	(mm)	1.75 ± 0.10	5.50 ± 0.05	8.00 ± 0.10	4.00 ± 0.10	2.00 ± 0.05	0.27 ± 0.03	12.00 ± 0.10	18.40 Max
	(inch)	0.069 ± 0.004	0.217 ± 0.002	0.315 ± 0.004	0.157 ± 0.004	0.079 ± 0.004	0.011 ± 0.001	0.472 ± 0.004	0.724 Max

## Marking Code

Part Number	Marking Code
CDBHD240-HF	MDS24
CDBHD260-HF	MDS26
CDBHD2100-HF	MDS210

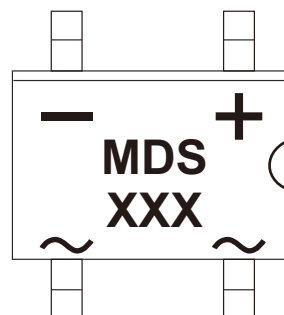

xx/xxx = Product type marking code

## Suggested P.C.B. PAD Layout

SIZE	MBS	
	(mm)	(inch)
A	0.90	0.035
B	1.84	0.072
C	2.40	0.094
D	6.00	0.236

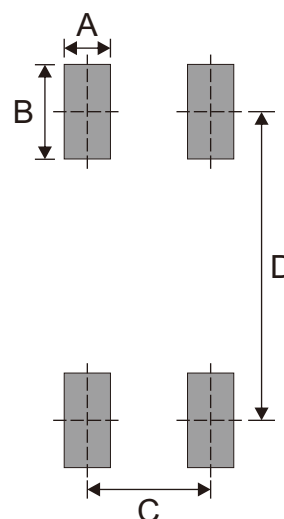

## Standard Packaging

Case Type	REEL PACK	
	REEL (pcs)	Reel Size (inch)
MBS	3,000	13

# Mouser Electronics

Authorized Distributor

Click to View Pricing, Inventory, Delivery & Lifecycle Information:

[Comchip Technology:](#)

[CDBHD2100-G](#) [CDBHD240-G](#) [CDBHD260-G](#)