



LGE

MUR3060P Super-Fast Recovery Diodes 30A FRED Pt



Features

- Adopt FRED chip
- Low forward Voltage drop
- Fast reverse recovery time
- High frequency operation
- High purity, high temperature epoxy encapsulation for enhanced mechanical strength and moisture resistance
- Guard ring for enhanced ruggedness and long term reliability

Typical Applications

- Typical applications are in switching power supplies, converters, freewheeling diodes, and reverse battery protection.

Mechanical Data

- **Package:** TO-247AC
Molding compound meets UL 94 V-0 flammability rating, RoHS-compliant
- **Terminals:** Tin plated leads, solderable per J-STD-002 and JESD22-B102
- **Polarity:** As marked

TO-247AC

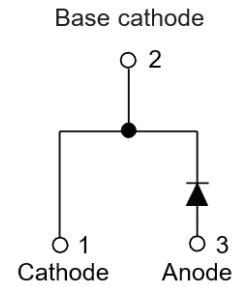
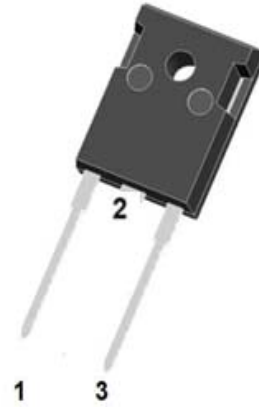

■ Maximum Ratings (T_j=25°C Unless otherwise specified)

PARAMETER	SYMBOL	UNIT	MUR3060P
Device marking code			MUR3060P
Repetitive Peak Reverse Voltage	VRRM	V	600
Average Rectified Output Current @60Hz sine wave, R-load, T _c (FIG.1)	I _O	A	30
Surge(Non-repetitive)Forward Current @60Hz half sine-wave, 1 cycle, T _a =25°C	IFSM	A	350
Current Squared Time @1ms≤t≤8.3ms T _j =25°C,	I ² t	A ² s	373
Single Pulse Avalanche Energy @ T _p =40uS, T _j =25°C,L=15mH	EAS	mJ	210
Storage Temperature	T _{stg}	°C	-55 ~ +175
Junction Temperature	T _j	°C	-55 ~ +175
Junction capacitance @4V,1MHz	C _j	pF	195

■ Electrical Characteristics

PARAMETER	SYMBOL	UNIT	TEST CONDITIONS	Min	Typ	Max
Instantaneous forward voltage drop per diode	V_{FM}	V	$I_{FM}=30.0A$ @ $T_j=25^{\circ}C$	-	1.65	1.85
			$I_{FM}=30.0A$ @ $T_j=125^{\circ}C$		1.55	1.70
DC reverse current at rated DC blocking voltage per diode	I_{RRM1}	uA	$V_{RM}=V_{RRM}$ $T_j=25^{\circ}C$	-	-	5.0
	I_{RRM2}		$V_{RM}=V_{RRM}$ $T_j=125^{\circ}C$	-	-	200
Reverse Recovery Time	T_{rr}	ns	$I_F=0.5A$ $I_{RM}=1A$ $I_{RR}=0.25A$ $T_j=25^{\circ}C$	-	35	40
Peak recovery current	I_{RRM}	A	$T_j=25^{\circ}C$	-	6.5	-
			$T_j=125^{\circ}C$			
Reverse recovery charge	Q_{rr}	nC	$T_j=25^{\circ}C$	-	590	-
			$T_j=125^{\circ}C$	-	2705	-

■ Thermal Characteristics ($T_j=25^{\circ}C$ Unless otherwise specified)

PARAMETER		SYMBOL	UNIT	MUR3060P
Thermal Resistance	Between junction and case	$R_{\theta J-C}$	$^{\circ}C/W$	1.0
	Between junction and Air	$R_{\theta J-A}$	$^{\circ}C/W$	50

■ Characteristics(Typical)

FIG3: Forward Voltage

FIG.4: Instantaneous Reverse Characteristics

FIG.5: Diagram of circuit and Testing wave form of reverse recovery time

■ Outline Dimensions

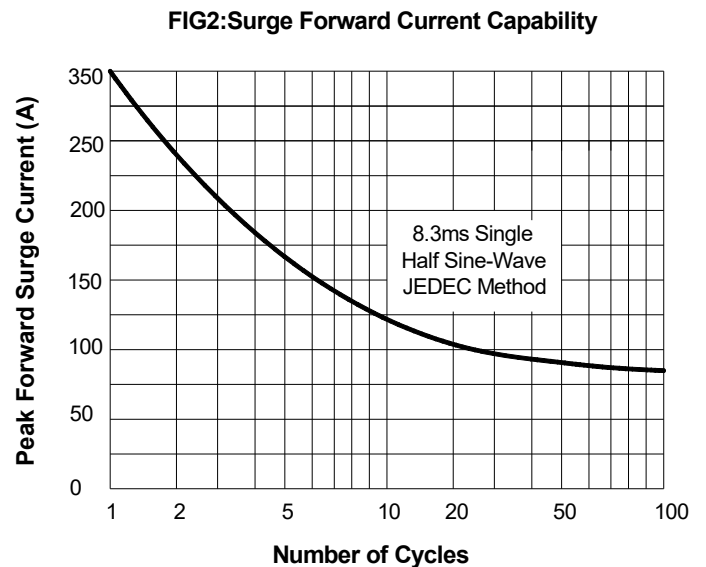
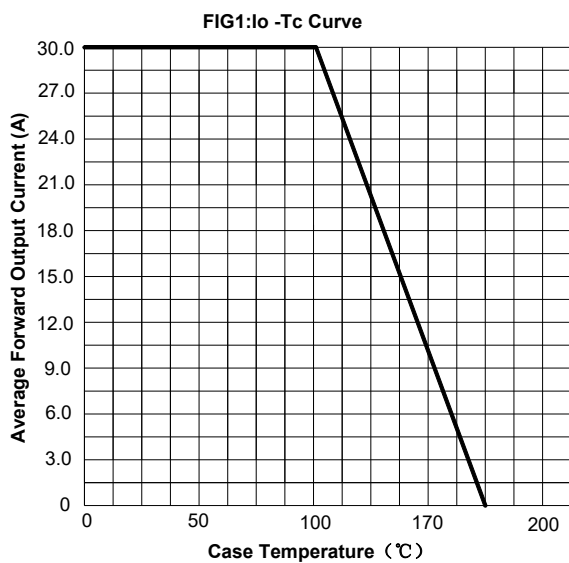
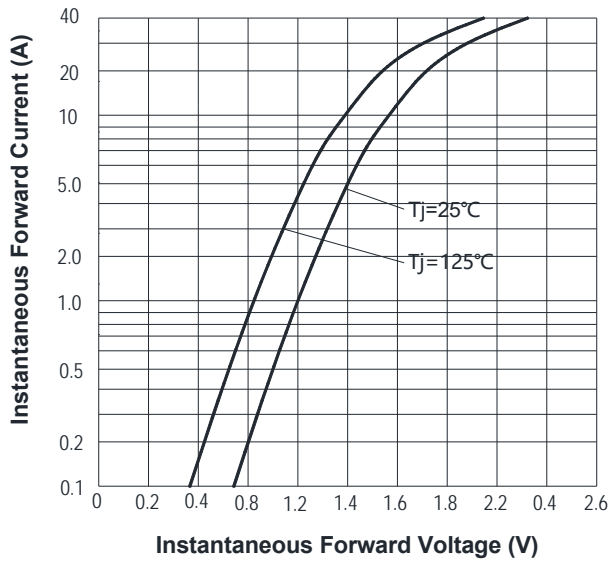
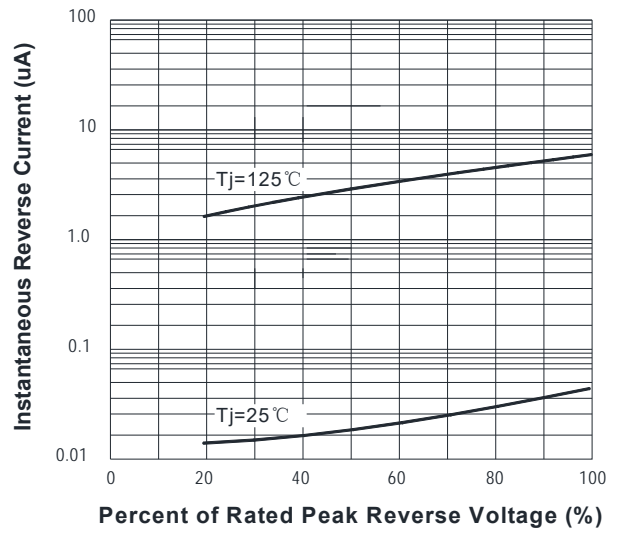
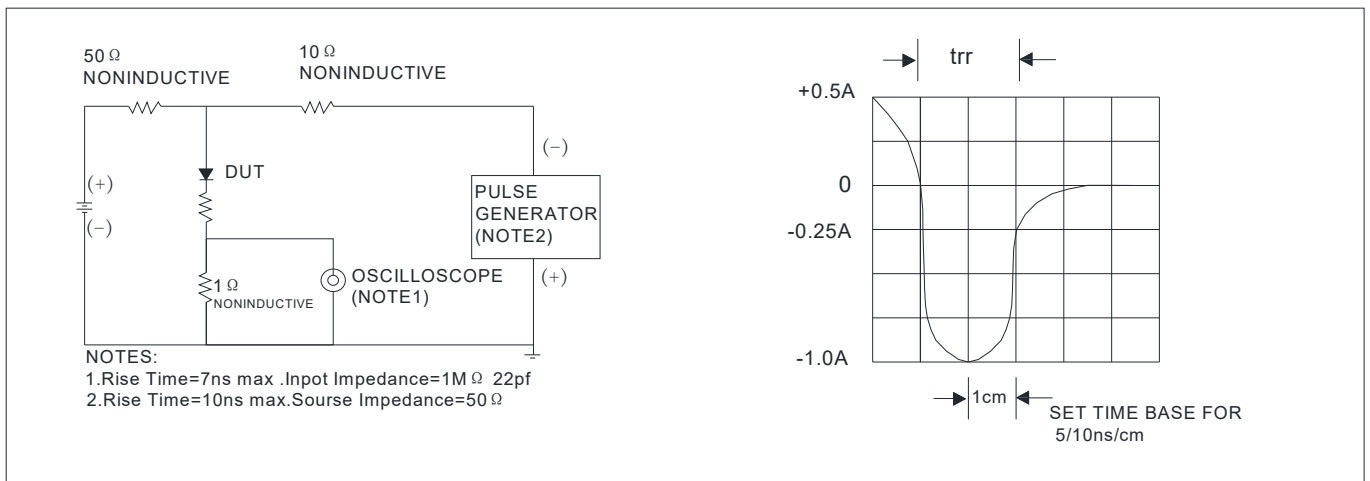
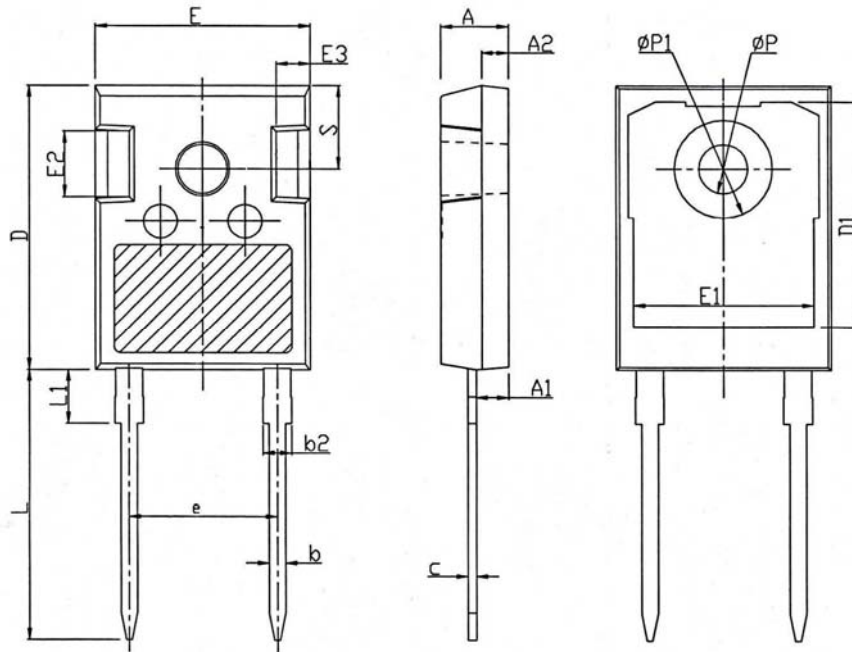

TO247-AC		
Dim	Min	Max
A	4.80	5.20
A1	2.21	2.61
A2	1.85	2.15
b	1.11	1.36
b2	1.91	2.21
c	0.51	0.75
D	20.70	21.30
D1	16.25	16.85
E	15.50	16.10
E1	13.00	13.60
E2	4.80	5.20
E3	2.30	2.70
e	10.88 TYP	
L	19.62	20.22
L1	-	4.30
ϕP	3.40	3.80
$\phi P1$	-	7.30
S	6.15 TYP	