

- ⊕ REPRESENTS A CRITICAL DIMENSION.
- MINIMUM PUSHOUT FORCE: .50 LBS.
- COPLANARITY TO BE:
-DH: -36 THRU -28 POS: .008[0.20]
-02 THRU -27 POS: .006[0.15]
-SV, -SH: -02 THRU 36 POS: .006 (FULL STRIP STOCK: .008).
- PACKAGE IN TUBES PER SHT 4, TABLE 2. ALL OTHER POSITIONS BULK PACKAGE.
- MAXIMUM CUT FLASH: .015[0.38].
- NOTCH OF PPP-12 TO BE ORIENTED TOWARD SAME END AS POSITION 1.
- ROWS TO BE WITHIN .004[0.10] OF ONE ANOTHER.
- 36 MAX POSITION AVAILABLE, -50 FOR STOCK ONLY.
- ENDWALL AFTER CUTTING: .033[0.84]±.005[0.13]
- DUE TO THE HIGH AMOUNT OF INSERTION FORCE NEEDED, THE -LC OPTION IS NOT COMPATIBLE WITH AUTO PLACEMENT. SAMTEC RECOMMENDS MANUAL PLACEMENT FOR ALL ASSEMBLIES WITH THE -LC OPTION.
- FOR -SV TAIL STYLE: EVEN CUTS LOSE 2 POSITIONS PER CUT; ODD CUTS LOSE 1 POSITION PER CUT.
- IF POLARIZATION OCCURS AT CENTER POSITION(S) OF BODY, MOVE PICK & PLACE PAD LEFT OR RIGHT TO NEXT AVAILABLE POSITION.
- THIS DIMENSION IS TO BE MEASURED RELATIVE TO DATUM -Z-.

DO NOT SCALE FROM THIS PRINT

SSM-1XX-XXX-XX-XX-XX-X-XX-XX

No OF POSITIONS
-02 THRU -36
(SEE NOTE 8)

OPTION
-TR: TAPE AND REEL
(SEE FIG 8, SHT 4)
(29 POSITIONS MAX)

PLATING SPECIFICATION

- S: 30μ" SELECTIVE GOLD IN CONTACT AREA, MATTE TIN ON TAIL.
- L: 10μ" SELECTIVE GOLD IN CONTACT AREA, MATTE TIN ON TAIL.
- T: MATTE TIN ON CONTACT AND TAIL.
- F: 3μ" SELECTIVE GOLD IN CONTACT AREA, MATTE TIN ON TAIL.
- STL: 30μ" SELECTIVE GOLD IN CONTACT AREA, TIN/LEAD (90/10) ON TAIL.
- H: 30μ" SELECTIVE GOLD IN CONTACT AREA, 3μ" SELECTIVE GOLD ON TAIL.
- LM: 10μ" SELECTIVE GOLD IN CONTACT AREA, MATTE TIN ON TAIL.
- TM: MATTE TIN ON CONTACT AND TAIL.
- FM: 3μ" SELECTIVE GOLD IN CONTACT

OPTION

- P: PICK AND PLACE PAD (ONLY AVAILABLE ON -SV, USE PPP-12, SEE FIG 6, SHT 3) (SEE NOTE 12)
- K: POLYIMIDE FILM PAD (SEE FIG 5, SHT 2) (USE K-DOT-.138-.250-.005) (NOT AVAILABLE ON -SH AND -DH)

POLARIZATION OPTION

- XX: POSITION TO BE POLARIZED (USE PK-06-N, SEE FIG 7, SHT 3 FOR POLARIZATION POSITIONS) (NOT AVAILABLE FOR -BE OPTION)

MOUNTING OPTION

- LC: LOCKING CLIP (USE LC-05-TM, SEE NOTE 10) (FOR -SH AND -DH USE MOLDED TO POSITION BODIES)

OPTION

- BE: BOTTOM ENTRY (ONLY AVAILABLE ON -SV) (USE SSM-XX-S-BE) (SEE FIG 2, SHT 2)

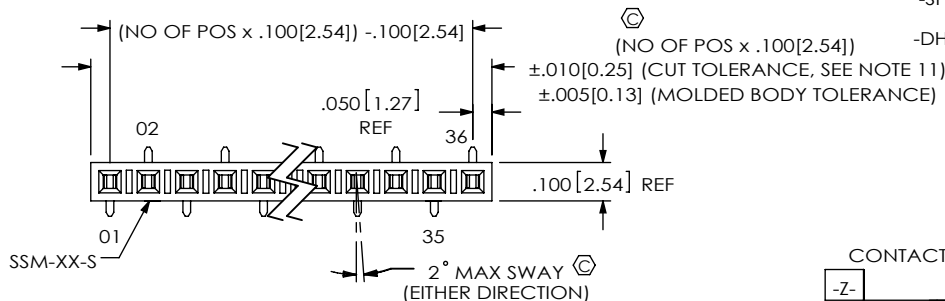

TAIL SPECIFICATION

- SV: SINGLE VERTICAL (SEE FIG 1) (USE SSM-XX-S)
- SH: SINGLE HORIZONTAL (SEE FIG 3, SHT 2) (USE SSM-XX-SH)
- DH: DOUBLE HORIZONTAL (SEE FIG 4, SHT 3) (USE BCH-XX-D)

TABLE 1		
BODY/LEAD STYLE	CONTACT #1	CONTACT #2
-SV	C-95-02-X	N/A
-SH	C-58-06-X	N/A
-DH	C-58-08-X	C-58-07-X

FLUSH TO .005[0.13] MAX

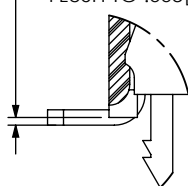

DETAIL 'D'
SCALE 8:1

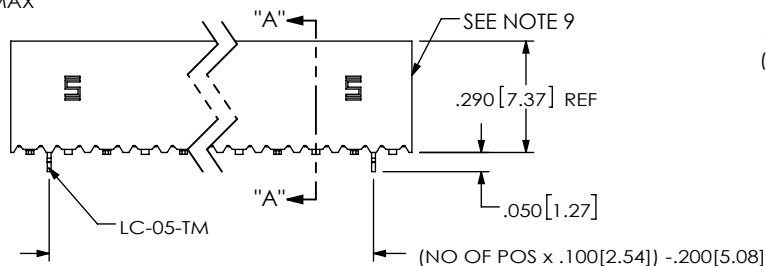
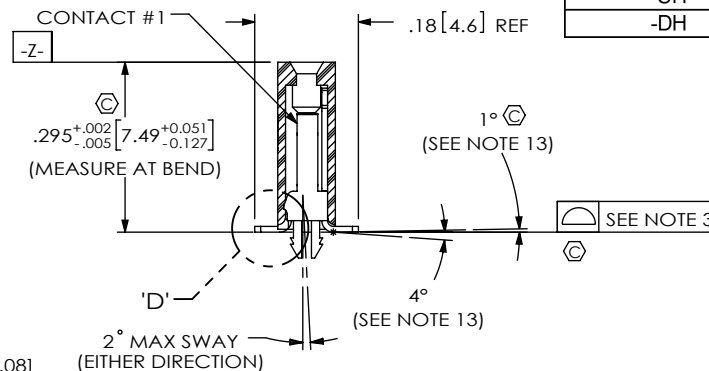
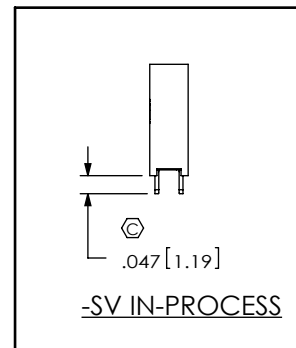

FIG 1
-SV: SINGLE VERTICAL ROW
(SSM-1XX-XXX-SV-LC SHOWN)



SECTION "A"-"A"
SCALE 3:1



UNLESS OTHERWISE SPECIFIED, DIMENSIONS ARE IN INCHES.
TOLERANCES ARE:
DECIMALS ANGLES
.XX: ±.01 [0.3] 2°
.XXX: ±.005 [0.13]
.XXXX: ±.0020 [0.051]

PROPRIETARY NOTE
THIS DOCUMENT CONTAINS CONFIDENTIAL AND PROPRIETARY INFORMATION AND ALL DESIGN, MANUFACTURING, REPRODUCTION, USE, PATENT RIGHTS AND SALES RIGHTS ARE EXPRESSLY RESERVED BY SAMTEC, INC. THIS DOCUMENT SHALL NOT BE DISCLOSED, IN WHOLE OR PART, TO ANY UNAUTHORIZED PERSON OR ENTITY NOR REPRODUCED, TRANSFERRED OR INCORPORATED IN ANY OTHER PROJECT IN ANY MANNER WITHOUT THE EXPRESS WRITTEN CONSENT OF SAMTEC, INC.

MATERIAL: DO NOT SCALE DRAWING SHEET SCALE: 2:1
INSULATOR: LCP, UL 94 VO, COLOR: BLACK
CONTACT: PHOS BRONZE

DESCRIPTION: .100[2.54] C.L. SURFACE MOUNT SOCKET STRIP

DWG. NO. SSM-1XX-XXX-XX-XX-XX-X-XX-XX

BY: KOLB 09/11/1998 SHEET 1 OF 4

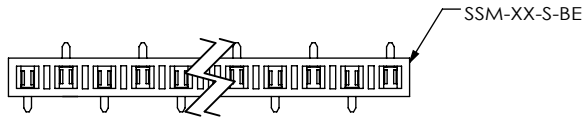

FIG 2
 -SV-BE: SINGLE VERTICAL ROW BOTTOM ENTRY
 (SSM-1XX-XXX-SV-BE SHOWN)
 (DIFFERENT AS SHOWN, OTHERWISE SAME AS FIG 1)

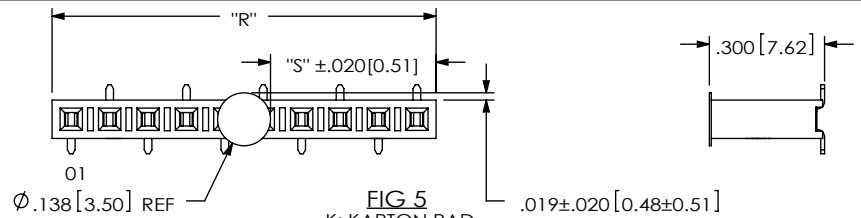
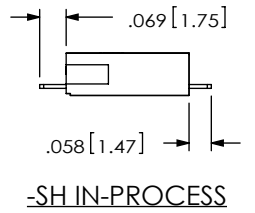
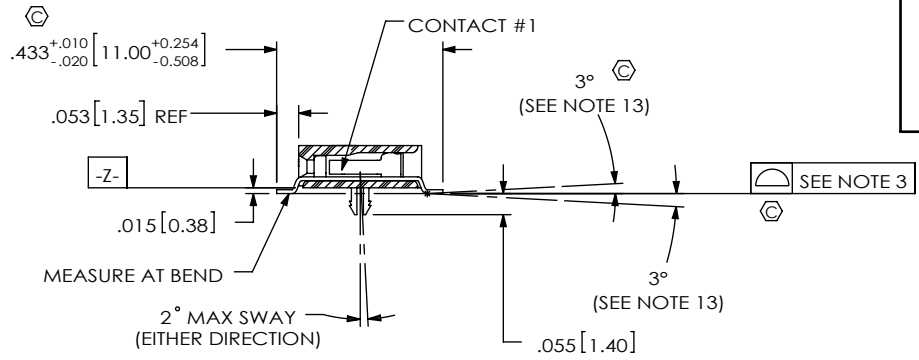
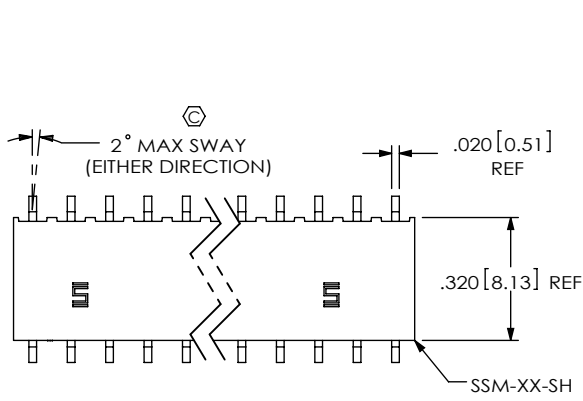

FIG 5
 -K: KAPTON PAD
 (SSM-110-XXX-SV-K SHOWN)
 (DIFFERENT AS SHOWN, OTHERWISE SAME AS FIG 1)
 "R" = SEE FIG 1, SHEET 1 FOR OAL
 "S" = "R"/2 - .0689 [1.750]



SECTION "B"- "B"

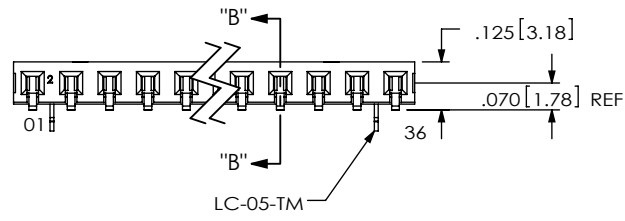

FIG 3
 -SH: SINGLE HORIZONTAL
 (SSM-136-XXX-SH-LC SHOWN)
 (DIFFERENT AS SHOWN, OTHERWISE SAME AS FIG 1)

PROPRIETARY NOTE
 THIS DOCUMENT CONTAINS CONFIDENTIAL AND PROPRIETARY INFORMATION AND ALL DESIGN, MANUFACTURING, REPRODUCTION, USE, PATENT RIGHTS AND SALES RIGHTS ARE EXPRESSLY RESERVED BY SAMTEC, INC. THIS DOCUMENT SHALL NOT BE DISCLOSED, IN WHOLE OR PART, TO ANY UNAUTHORIZED PERSON OR ENTITY NOR REPRODUCED, TRANSFERRED OR INCORPORATED IN ANY OTHER PROJECT IN ANY MANNER WITHOUT THE EXPRESS WRITTEN CONSENT OF SAMTEC, INC.

DO NOT SCALE DRAWING
 SHEET SCALE: 2:1



520 PARK EAST BLVD, NEW ALBANY, IN 47150
 PHONE: 812-944-6733 FAX: 812-948-5047
 e-Mail info@SAMTEC.com code 55322

DESCRIPTION:
 .100 [2.54] C.L. SURFACE MOUNT SOCKET STRIP

DWG. NO.
SSM-1XX-XXX-XX-XX-XX-X-XX-XX

BY: KOLB 09/11/1998 SHEET 2 OF 4

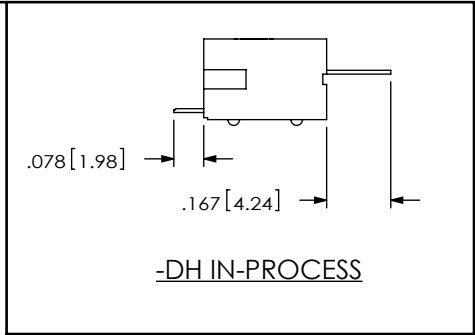
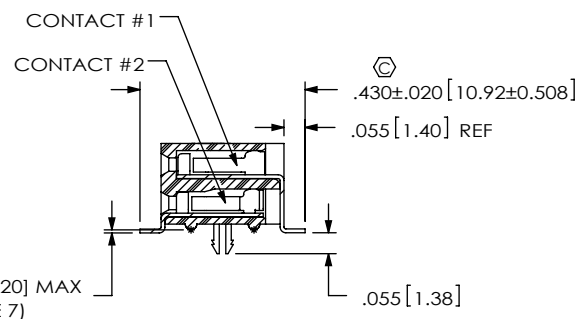
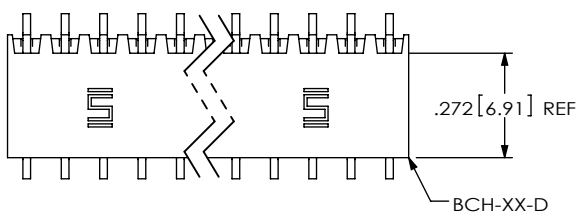

SECTION "C"- "C"

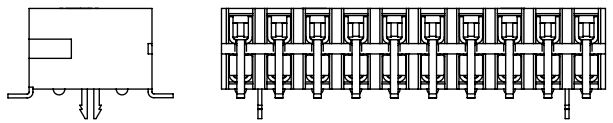
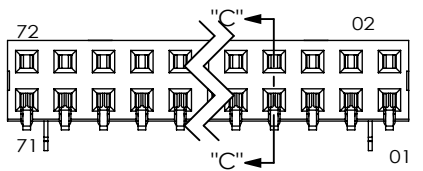

FIG 4
-DH: DOUBLE HORIZONTAL
(SSM-1XX-XXX-DH-LC SHOWN)
(DIFFERENT AS SHOWN, OTHERWISE SAME AS FIG 3)

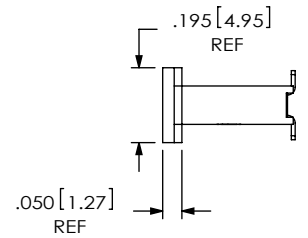
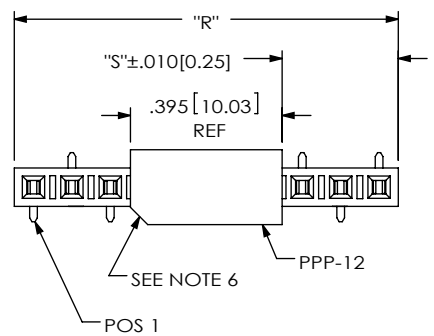

FIG 6
-P: PICK AND PLACE PAD
(SSM-110-XXX-SV-P SHOWN)
-02 AND -03 POS NOT AVAILABLE WITH POLARIZATION
-04 POS - CANNOT OFFER IF POLARIZATION IS POS 2 OR 3
-05 POS - CANNOT OFFER IF POLARIZATION IS POS 3
*MUST USE TR ON POS 2 & 3
(DIFFERENT AS SHOWN, OTHERWISE SAME AS FIG 1)
"R" = SEE FIG 1, SHEET 1 FOR OAL
"S" = IF NO OF POS IS EVEN: "R"/2 - .1975[5.017]
IF NO OF POS IS ODD: "R"/2 - .2475[6.287]

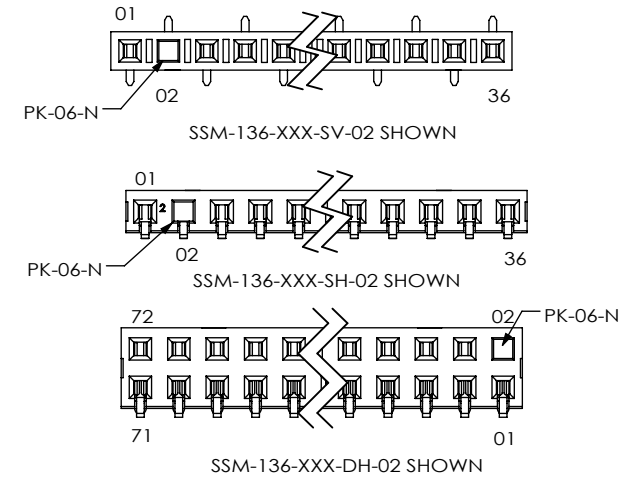

FIG 7
POLARIZATION
(DIFFERENT AS SHOWN, OTHERWISE SAME AS FIG 1)

IF CENTER POS IS POLARIZED, USE TABLE BELOW

NO OF POS	DIRECTION PAD MOVED (1 POS TO NEXT AVAIL)	MIN POS	FORMULA
EVEN	LEFT	6	"S" = "R"/2 - .0975[2.477]
EVEN	RIGHT	6	"S" = "R"/2 - .2975[7.557]
ODD	LEFT	5	"S" = "R"/2 - .1475[3.747]
ODD	RIGHT	7	"S" = "R"/2 - .3475[8.827]

PROPRIETARY NOTE
THIS DOCUMENT CONTAINS CONFIDENTIAL AND PROPRIETARY INFORMATION AND ALL DESIGN, MANUFACTURING, REPRODUCTION, USE, PATENT RIGHTS AND SALES RIGHTS ARE EXPRESSLY RESERVED BY SAMTEC, INC. THIS DOCUMENT SHALL NOT BE DISCLOSED, IN WHOLE OR PART, TO ANY UNAUTHORIZED PERSON OR ENTITY NOR REPRODUCED, TRANSFERRED OR INCORPORATED IN ANY OTHER PROJECT IN ANY MANNER WITHOUT THE EXPRESS WRITTEN CONSENT OF SAMTEC, INC.



DO NOT SCALE DRAWING
SHEET SCALE: 3:2

DESCRIPTION:
.100[2.54] C.L. SURFACE MOUNT SOCKET STRIP
DWG. NO.
SSM-1XX-XXX-XX-XX-XX-X-XX-XX
BY: KOLB 09/11/1998 SHEET 3 OF 4

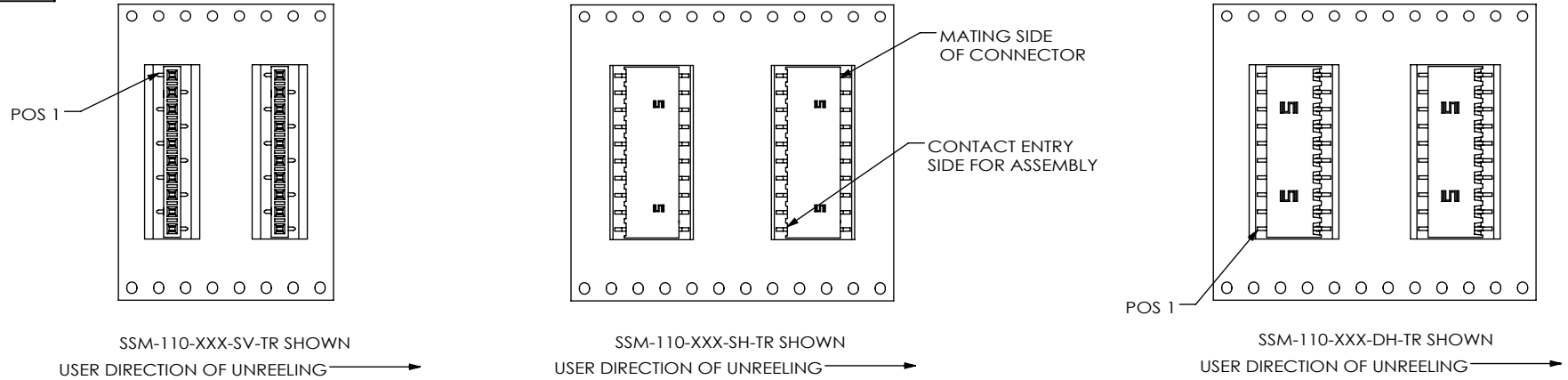

FIG 8
-TR: TAPE AND REEL
SCALE 1:1

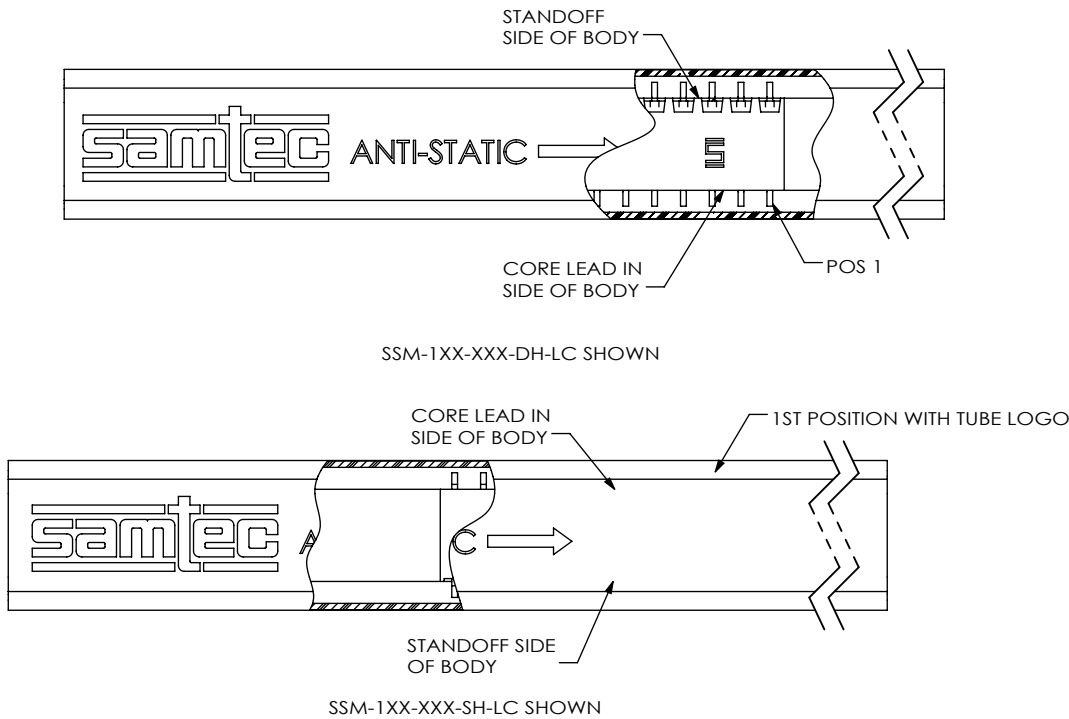

FIG 9
TUBE VIEWS

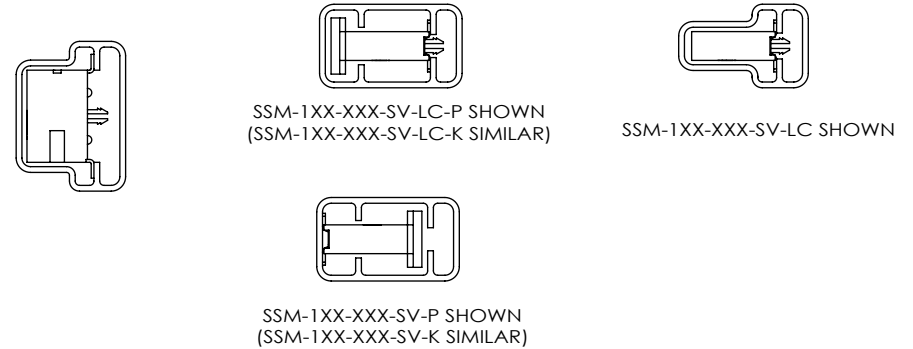

TABLE 2			
PART NUMBER	TUBE	PLUG	POS TO BE TUBED (SEE NOTE 4)
SSM-SV	PT-1-24-05-15	TP-24 (2)	03-36
SSM-SV-LC			02-36
SSM-SV-P	PT-1-24-02-15	TP-03 (2)	04-36
SSM-SV-K			03-36
SSM-SH	PT-1-24-07-15	TP-03 (2)	02-36
SSM-DH	PT-1-24-06-15	TP-07 (2)	02-36

PROPRIETARY NOTE
THIS DOCUMENT CONTAINS CONFIDENTIAL AND PROPRIETARY INFORMATION AND ALL DESIGN, MANUFACTURING, REPRODUCTION, USE, PATENT RIGHTS AND SALES RIGHTS ARE EXPRESSLY RESERVED BY SAMTEC, INC. THIS DOCUMENT SHALL NOT BE DISCLOSED, IN WHOLE OR PART, TO ANY UNAUTHORIZED PERSON OR ENTITY NOR REPRODUCED, TRANSFERRED OR INCORPORATED IN ANY OTHER PROJECT IN ANY MANNER WITHOUT THE EXPRESS WRITTEN CONSENT OF SAMTEC, INC.

DO NOT SCALE DRAWING

SHEET SCALE: 3:2



520 PARK EAST BLVD, NEW ALBANY, IN 47150
PHONE: 812-944-6733 FAX: 812-948-5047
e-Mail info@SAMTEC.com code 53322

DESCRIPTION:
[.100[2.54] C.L. SURFACE MOUNT SOCKET STRIP

DWG. NO.
SSM-1XX-XXX-XX-XX-XX-X-XX-XX

BY: KOLB 09/11/1998 SHEET 4 OF 4