

Specifications

Insulation Resistance: 5,000MΩ min.
 Withstanding Voltage: 1,000 V AC
 Contact Resistance: 10mΩ max.
 Current Rating: 5A
 Operating Temp. Range: -55°C to +105°C

Materials and Finish

Insulator: Polyester Resin and
 Glass Fiber reinforced (UL94V-0)
 Contacts: Copper Alloy
 Plating: Gold over Nickel



Features

- ⇨ Stamped contacts
- ⇨ Full gold plating

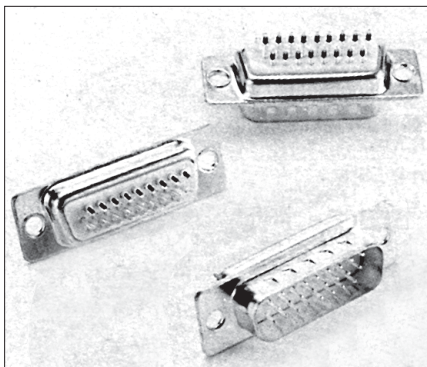

Part Numbers

14 Contacts Part No. CT09-15PK211



15 Contacts Part No. CT09-15P

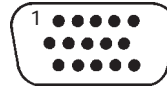

26 Contacts Part No. CT15-26P



44 Contacts Part No. CT25-44P



62 Contacts Part No. CT37-62P



78 Contacts Part No. CT50-78P

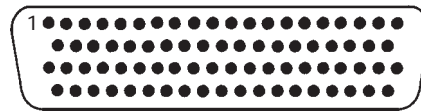

Outline Connector Dimensions

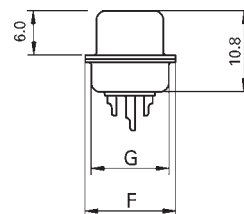
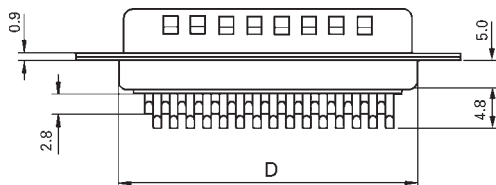
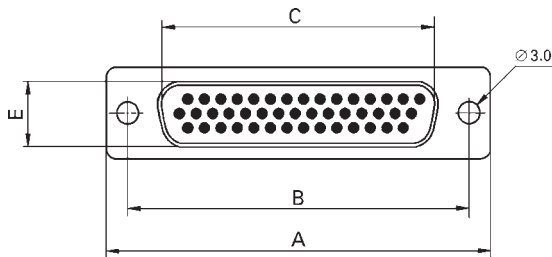

Part Number	No. of Contacts	A	B	C	D	E	F	G
CT09-15PK211	14	30.80	25.00	17.70	19.30	9.60	12.50	10.70
CT09-15P	15	30.80	25.00	17.70	19.30	9.60	12.50	10.70
CT15-26P	26	39.10	33.30	26.00	27.50	9.60	12.50	10.70
CT25-44P	44	53.00	47.00	40.20	41.30	9.60	12.50	10.70
CT37-62P	62	69.30	63.50	56.70	57.70	9.60	12.50	10.70
CT50-78P	78	66.90	61.10	54.00	55.30	13.30	15.40	13.60

Specifications

Insulation Resistance: 5,000MΩ min.
 Withstanding Voltage: 1,000V AC
 Contact Resistance: 10mΩ max.
 Current Rating: 5A
 Operating Temp. Range: -55°C to +105°C

Materials and Finish

Insulator: Polyester Resin
 and Glass Fiber reinforced (UL94V-0)
 Contacts: Copper Alloy
 Plating: Gold over Nickel



Features

- ⇨ Stamped contacts
- ⇨ Full gold plating

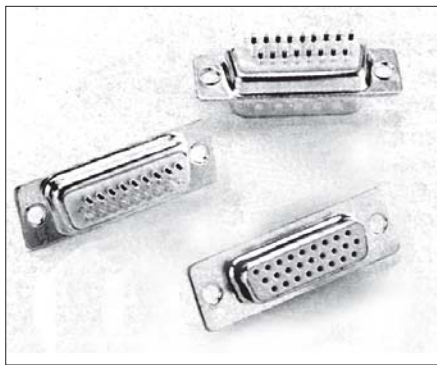

Part Numbers

15 Contacts Part No. CT09-15S

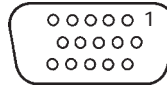

26 Contacts Part No. CT15-26S

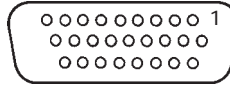

44 Contacts Part No. CT25-44S

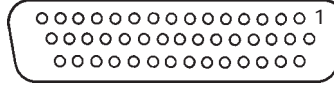

62 Contacts Part No. CT37-62S

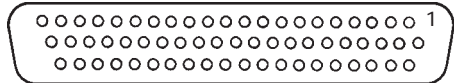

78 Contacts Part No. CT50-78S

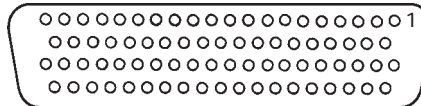

Outline Connector Dimensions

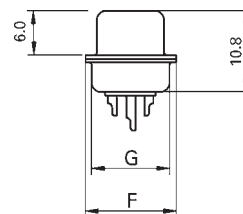
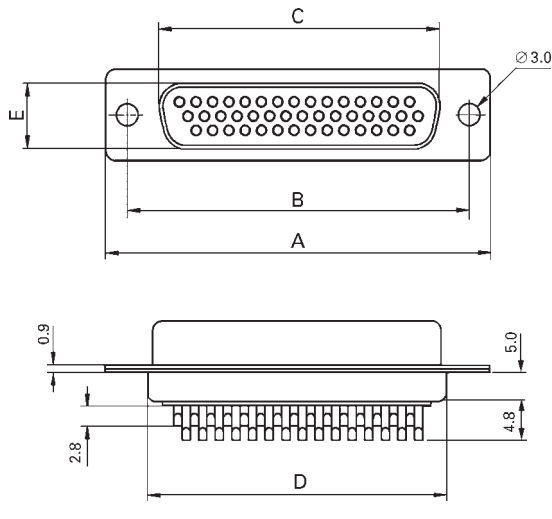

Part Number	No. of Contacts	A	B	C	D	E	F	G
CT09-15S	15	30.80	25.00	16.30	19.20	7.80	12.50	10.70
CT15-26S	26	39.10	33.30	24.60	27.70	7.80	12.50	10.70
CT25-44S	44	53.00	47.00	38.30	41.10	7.80	12.50	10.70
CT37-62S	62	69.30	63.50	54.80	57.30	7.80	12.50	10.70
CT50-78S	78	66.90	61.10	52.40	55.10	10.70	15.40	13.60