

V_{DS}	-30	V
V_{GS Max}	± 20	V
R_{DS(on) max} (@ V _{GS} = -10V)	165	mΩ
R_{DS(on) max} (@ V _{GS} = -4.5V)	270	mΩ

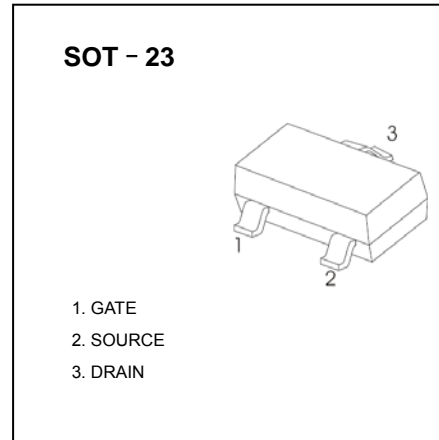

Features

- Industry-standard pinout
- Compatible with existing Surface Mount Techniques
- RoHS compliant containing no lead, no bromide and no halogen
- MSL1, Consumer qualification
-

Benefits

- Increased reliability
- Multi-vendor compatibility
- Easier manufacturing
- Environmentally friendly

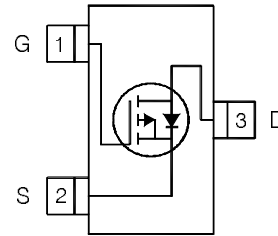

Absolute Maximum Ratings

Symbol	Parameter	Max	Units
V _{DS}	Drain-Source Voltage	-30	V
I _D @ T _A = 25°C	Continuous Drain Current, V _{GS} @ 10V	-2.3	A
I _D @ T _A = 70°C	Continuous Drain Current, V _{GS} @ 10V	-1.8	
I _{DM}	Pulsed Drain Current	-12	
P _D @ T _A = 25°C	Maximum Power Dissipation	1.25	W
P _D @ T _A = 70°C	Maximum Power Dissipation	0.80	
	Linear Derating Factor	0.01	W/°C
V _{GS}	Gate-to-Source Voltage	± 20	V
T _J , T _{STG}	Junction and Storage Temperature Range	-55 to + 150	°C

Thermal Resistance

Symbol	Parameter	Typ.	Max.	Units
R _{θJA}	Junction-to-Ambient ③	—	100	°C/W
R _{θJA}	Junction-to-Ambient (t<10s) ④	—	99	

- ① Repetitive rating; pulse width limited by max. junction temperature.
- ② Pulse width ≤ 400µs; duty cycle ≤ 2%.
- ③ Surface mounted on 1 in square Cu board.

Electric Characteristics @ T_J = 25°C (unless otherwise specified)

Symbol	Parameter	Min.	Typ.	Max.	Units	Conditions
V _{(BR)DSS}	Drain-to-Source Breakdown Voltage	-30	—	—	V	V _{GS} = 0V, I _D = -250μA
ΔV _{(BR)DSS} /ΔT _J	Breakdown Voltage Temp. Coefficient	—	-3.7	—	mV/°C	Reference to 25°C, I _D = -1mA
R _{DS(on)}	Static Drain-to-Source On-Resistance	—	135	165	mΩ	V _{GS} = -10V, I _D = -2.3A ②
		—	220	270		V _{GS} = -4.5V, I _D = -1.8A ②
V _{GS(th)}	Gate Threshold Voltage	-1.3	—	-2.4	V	V _{DS} = V _{GS} , I _D = -10μA
I _{DSS}	Drain-to-Source Leakage Current	—	—	1.0	μA	V _{DS} = -24V, V _{GS} = 0V
		—	—	150		V _{DS} = -24V, V _{GS} = 0V, T _J = 125°C
I _{GSS}	Gate-to-Source Forward Leakage	—	—	-100	nA	V _{GS} = -20V
	Gate-to-Source Reverse Leakage	—	—	100		V _{GS} = 20V
R _G	Internal Gate Resistance	—	21	—	Ω	
g _{fs}	Forward Transconductance	2.3	—	—	S	V _{DS} = -10V, I _D = -2.3A
Q _g	Total Gate Charge	—	2.0	—	nC	I _D = -2.3A
Q _{gs}	Gate-to-Source Charge	—	0.57	—		V _{DS} = -15V
Q _{gd}	Gate-to-Drain ("Miller") Charge	—	1.2	—		V _{GS} = -4.5V ②
t _{d(on)}	Turn-On Delay Time	—	7.5	—	ns	V _{DD} = -15V ②
t _r	Rise Time	—	14	—		I _D = -1.0A
t _{d(off)}	Turn-Off Delay Time	—	9.0	—		R _G = 6.8Ω
t _f	Fall Time	—	8.6	—		V _{GS} = -4.5V
C _{iss}	Input Capacitance	—	160	—	pF	V _{GS} = 0V
C _{oss}	Output Capacitance	—	39	—		V _{DS} = -25V
C _{rss}	Reverse Transfer Capacitance	—	25	—		f = 1.0KHz

Source - Drain Ratings and Characteristics

Symbol	Parameter	Min.	Typ.	Max.	Units	Conditions
I _S	Continuous Source Current (Body Diode)	—	—	-1.3	A	MOSFET symbol showing the integral reverse p-n junction diode. 
I _{SM}	Pulsed Source Current (Body Diode) ①	—	—	-12		
V _{SD}	Diode Forward Voltage	—	—	-1.2	V	T _J = 25°C, I _S = -1.3A, V _{GS} = 0V ②
t _{rr}	Reverse Recovery Time	—	12	18	ns	T _J = 25°C, V _R = -24V, I _F = -1.3A
Q _{rr}	Reverse Recovery Charge	—	5.3	8.0	nC	di/dt = 100A/μs ②

TYPICAL CHARACTERISTICS (25 °C, unless otherwise noted)

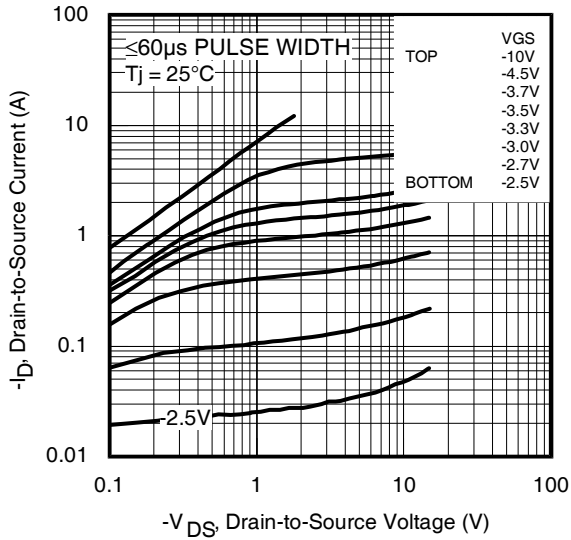

Fig 1. Typical Output Characteristics

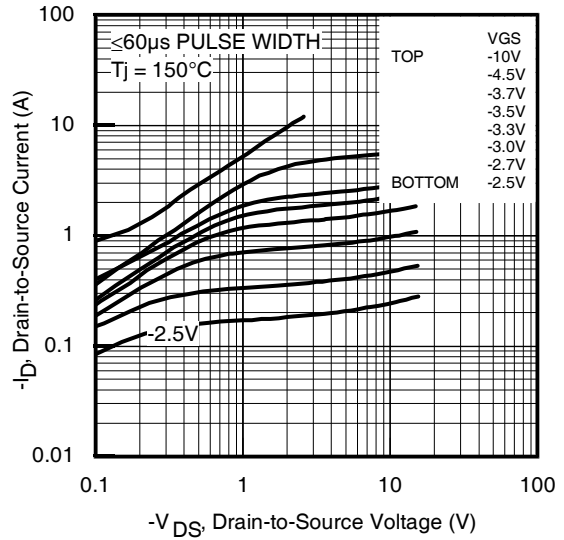

Fig 2. Typical Output Characteristics

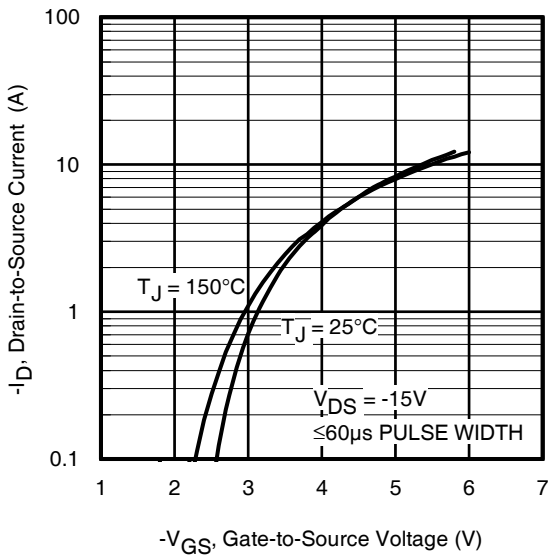

Fig 3. Typical Transfer Characteristics

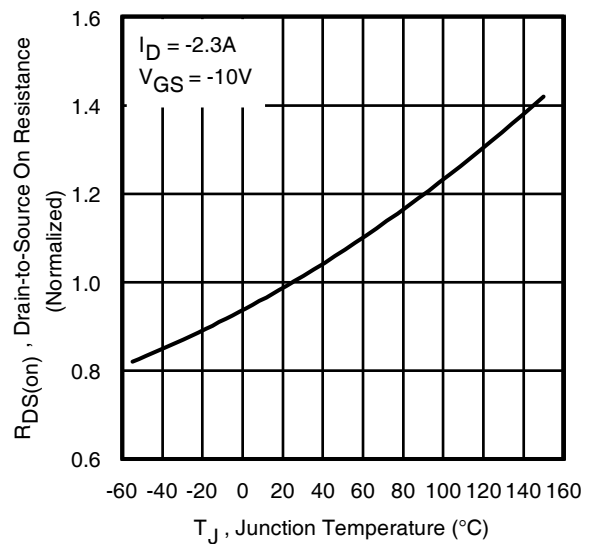

Fig 4. Normalized On-Resistance vs. Temperature

TYPICAL CHARACTERISTICS (25 °C, unless otherwise noted)

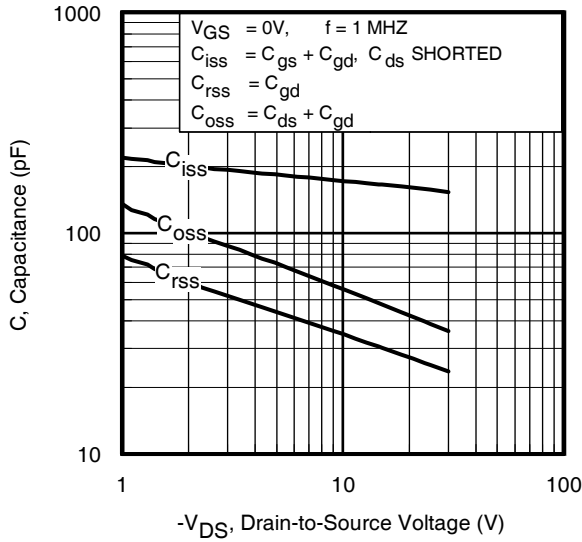

Fig 5. Typical Capacitance vs. Drain-to-Source Voltage

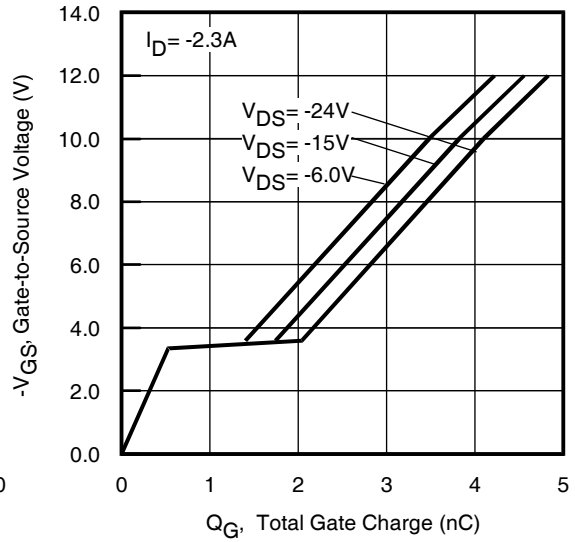

Fig 6. Typical Gate Charge vs. Gate-to-Source Voltage

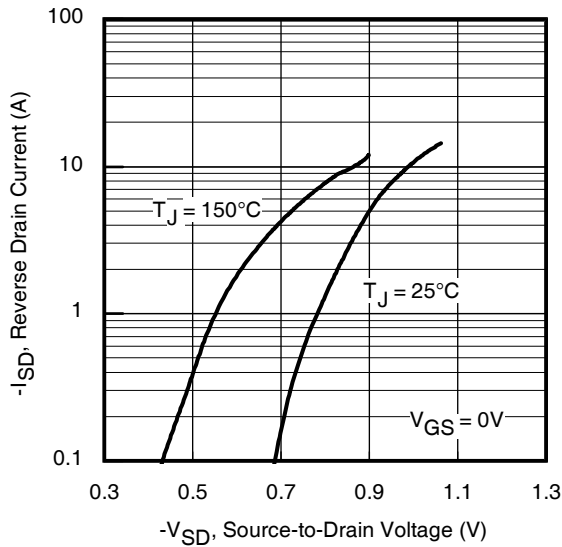

Fig 7. Typical Source-Drain Diode Forward Voltage

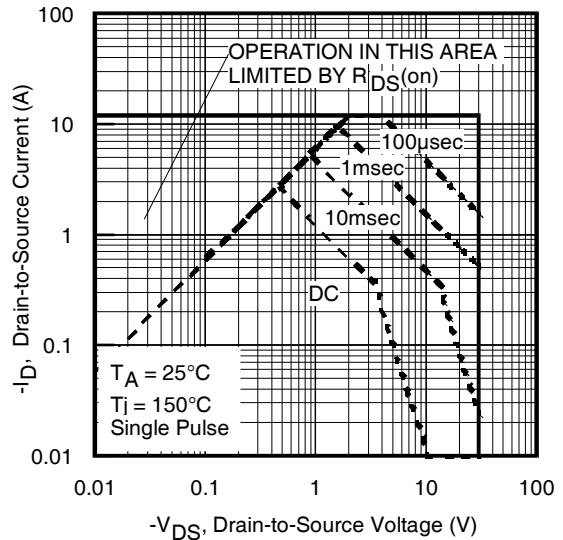

Fig 8. Maximum Safe Operating Area

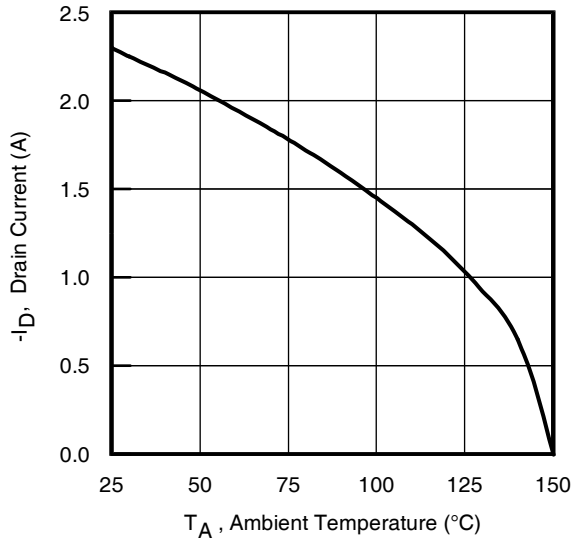

Fig 9. Maximum Drain Current vs. Ambient Temperature

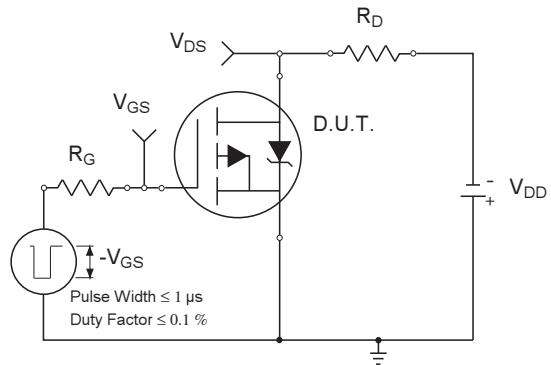

Fig 10a. Switching Time Test Circuit

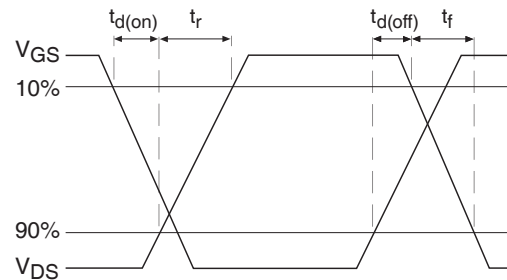

Fig 10b. Switching Time Waveforms

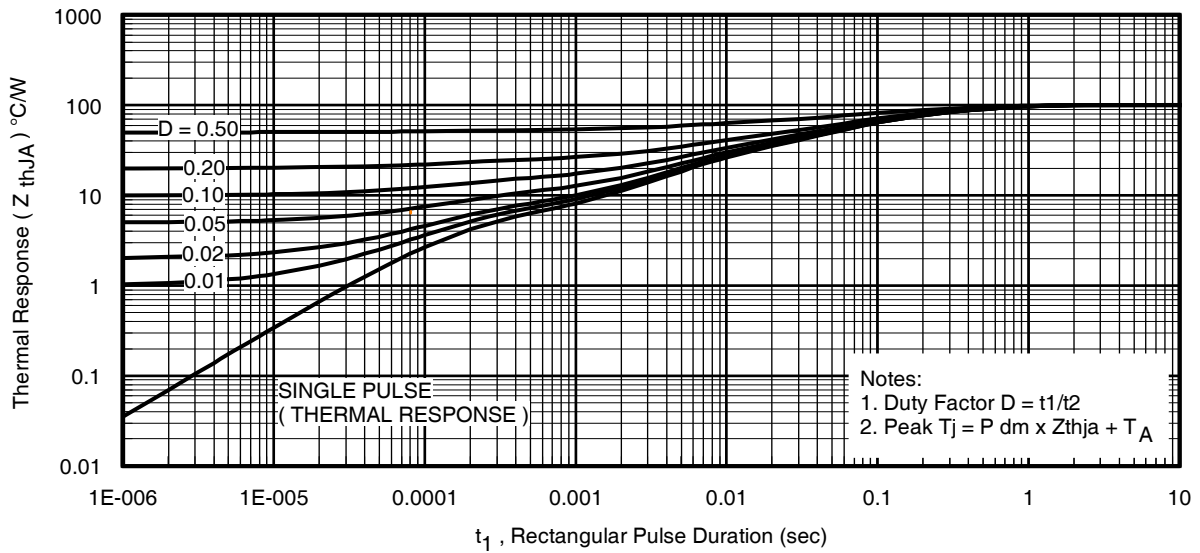

Fig 11. Typical Effective Transient Thermal Impedance, Junction-to-Ambient

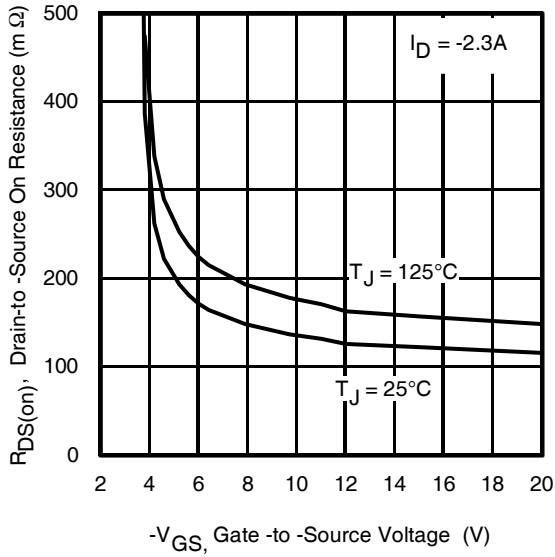

Fig 12. Typical On-Resistance vs. Gate Voltage

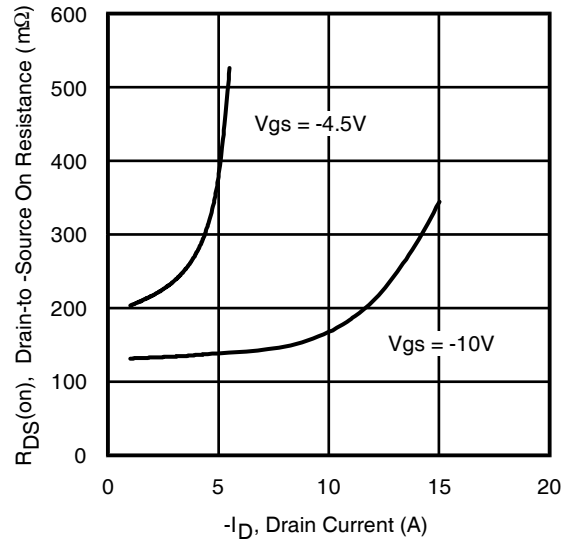

Fig 13. Typical On-Resistance vs. Drain Current

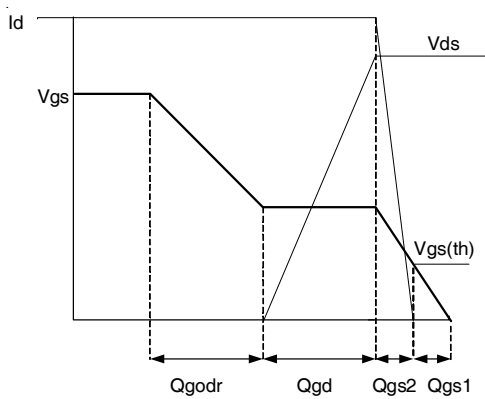

Fig 14a. Gate Charge Waveform

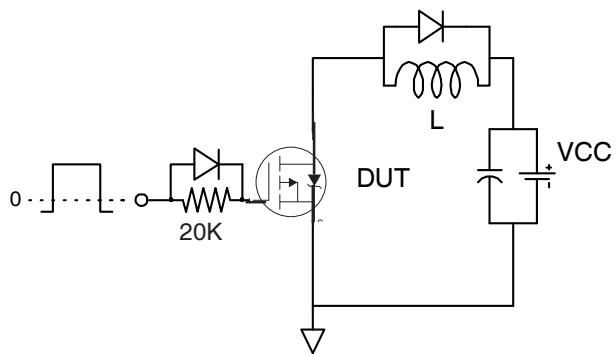

Fig 14b. Gate Charge Test Circuit

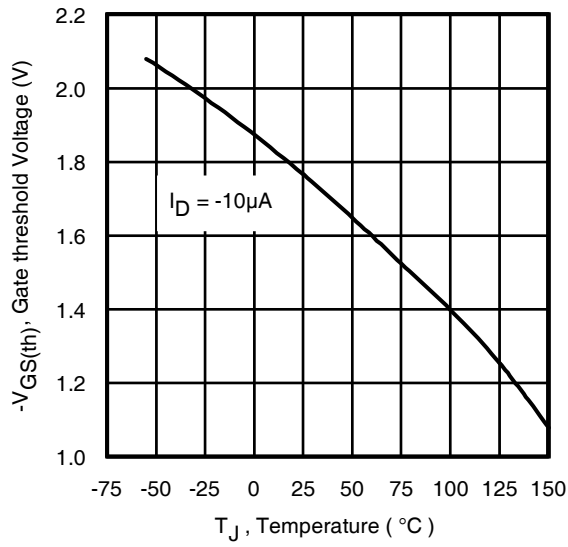

Fig 15. Typical Threshold Voltage vs. Junction Temperature

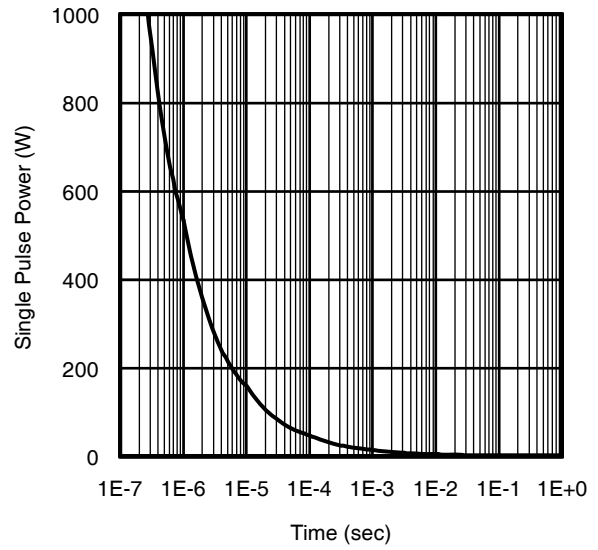
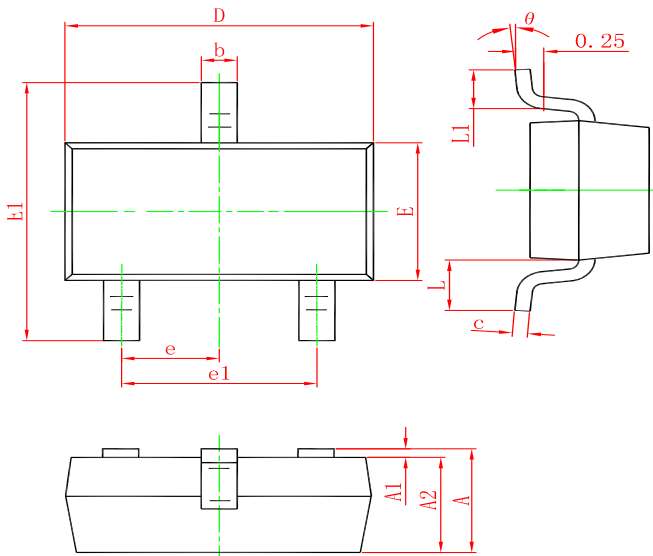

Fig 16. Typical Power vs. Time

SOT-23 PACKAGE OUTLINE DIMENSIONS



Symbol	Dimensions In Millimeters		Dimensions In Inches	
	Min.	Max.	Min.	Max.
A	0.900	1.150	0.035	0.045
A1	0.000	0.100	0.000	0.004
A2	0.900	1.050	0.035	0.041
b	0.300	0.500	0.012	0.020
c	0.080	0.150	0.003	0.006
D	2.800	3.000	0.110	0.118
E	1.200	1.400	0.047	0.055
E1	2.250	2.550	0.089	0.100
e	0.950 TYP.		0.037 TYP.	
e1	1.800	2.000	0.071	0.079
L	0.550 REF.		0.022 REF.	
L1	0.300	0.500	0.012	0.020
theta	0°	8°	0°	8°

Marking

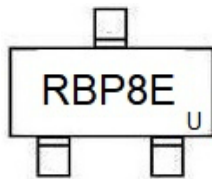

Ordering information

Order code	Package	Baseqty	Deliverymode
UMW IRLML9303TR	SOT-23	3000	Tape and reel