

Vol.

**07**

User's Manual

# [ SuperCapacitor ] User's Manual

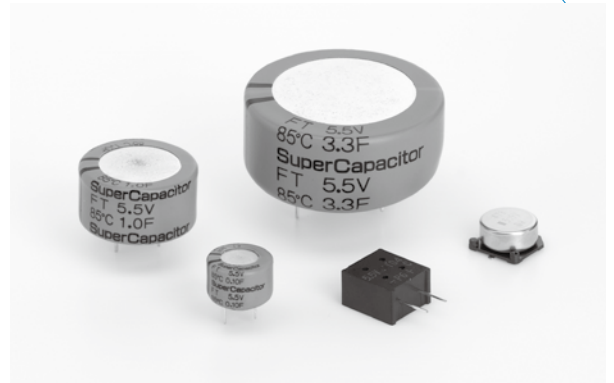

## SuperCapacitor USER'S MANUAL



- All specifications in this catalog and production status of products are subject to change without notice. Prior to the purchase, please contact TOKIN for updated product data.
- Please request for a specification sheet for detailed product data prior to the purchase.
- Before using the product in this catalog, please read "Precautions" and other safety precautions listed in the printed version catalog.

## For Correct Use of SuperCapacitor

1. Please confirm the operating condition and the specifications of the SuperCapacitors before using them.
2. The electrolyte of these SuperCapacitors is sealed with material such as rubber.

When you use the capacitors for long time at high temperature, the moisture of the electrolyte evaporates and the equivalent series resistance (E.S.R.) increases.

The fundamental failure mode is the open mode depending on E.S.R. increase.

When using these capacitors, incorporate appropriate safety measures in your design, such as redundancy and measures to prevent misoperation.

3. Please read 'Notes on Using the SuperCapacitor' on page 30 when you design the circuits using the SuperCapacitors.



- All specifications in this catalog and production status of products are subject to change without notice. Prior to the purchase, please contact TOKIN for updated product data.
- Please request for a specification sheet for detailed product data prior to the purchase.
- Before using the product in this catalog, please read "Precautions" and other safety precautions listed in the printed version catalog.

**CONTENTS**

1. SYSTEMATIC CHART OF SuperCapacitor .....	4
2. STRUCTURE AND PRINCIPLE .....	5
3. PRODUCT LINE-UP FOR SuperCapacitor .....	7
4. FEATURES .....	8
5. MANUFACTURING AND RELIABILITY & QUALITY CONTROL.....	9
6. PERFORMANCE .....	11
7. CHARACTERISTIC MEASURING METHOD.....	19
8. SELECTION GUIDE .....	21
9. OPERATING PRECAUTIONS .....	30
10. FC-SERIES SuperCapacitor (Surface Mounting Type, Automatic Assembly) .....	32
11. FM-SERIES SuperCapacitor (Resin Molded, Automatic Assembly) .....	40
12. FG-SERIES SuperCapacitor .....	53
13. FT-SERIES SuperCapacitor (Wide Operating Temperature Range, Low ESR) .....	61
14. FY-SERIES SuperCapacitor .....	67
15. FR-SERIES SuperCapacitor (Wide Operating Temperature Range).....	75
16. FS-SERIES SuperCapacitor (Miniaturized, Low ESR) .....	80
17. FA-SERIES/FE-SERIES SuperCapacitor (Low ESR) .....	87
18. APPLICATION OF SuperCapacitor .....	95



- All specifications in this catalog and production status of products are subject to change without notice. Prior to the purchase, please contact TOKIN for updated product data.
- Please request for a specification sheet for detailed product data prior to the purchase.
- Before using the product in this catalog, please read "Precautions" and other safety precautions listed in the printed version catalog.



# SYSTEMATIC CHART OF SuperCapacitor

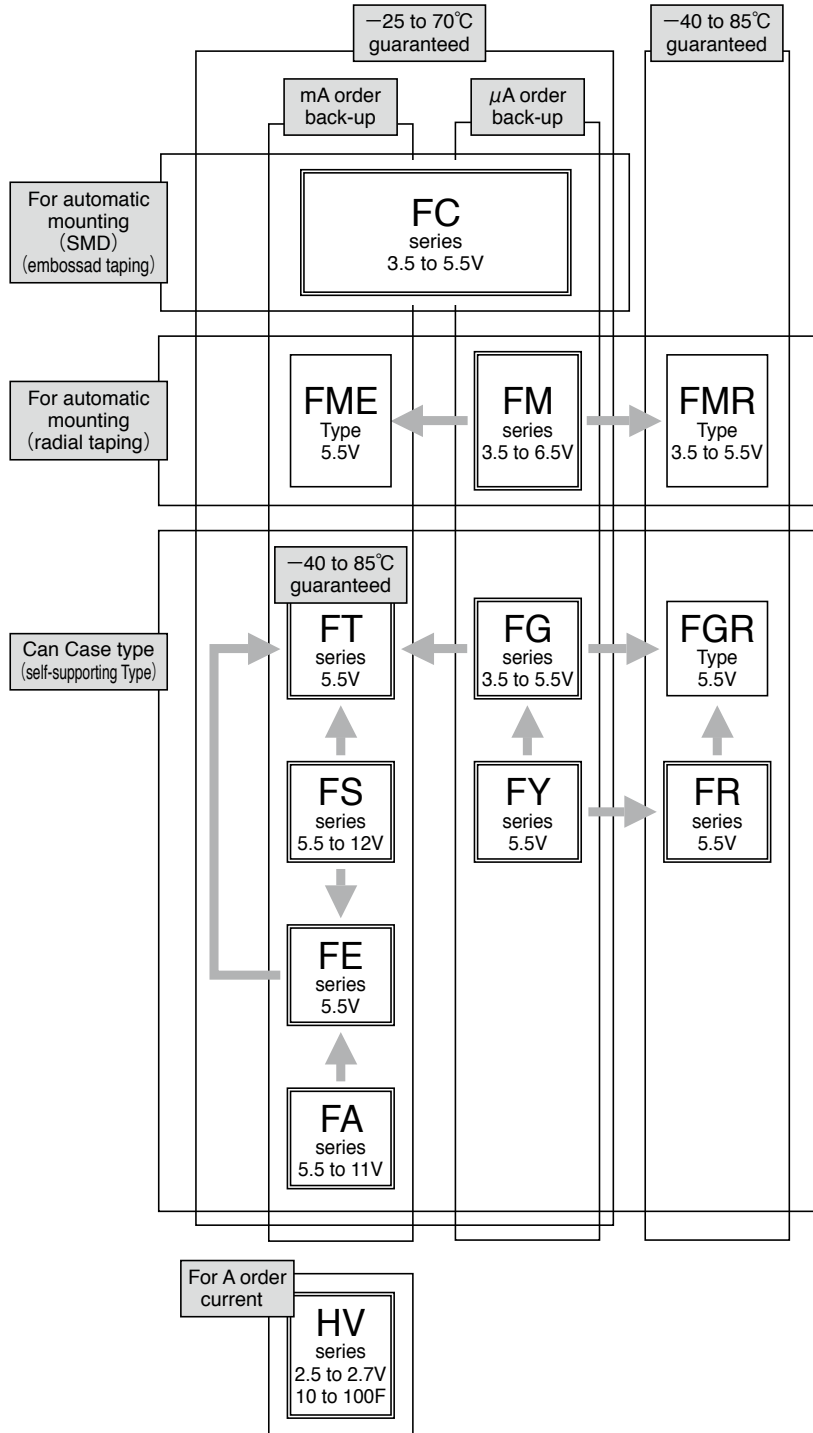

- All specifications in this catalog and production status of products are subject to change without notice. Prior to the purchase, please contact TOKIN for updated product data.
- Please request for a specification sheet for detailed product data prior to the purchase.
- Before using the product in this catalog, please read "Precautions" and other safety precautions listed in the printed version catalog.

# 2

## STRUCTURE AND PRINCIPLE

An electrical double layer capacitor is different from a common capacitor using dielectric substance.

When two different phases of solid and liquid come into contact, positive and negative charges are distributed confronting with each other in a very small distance on the boundary surface. A layer which spreads in the vicinity of this boundary surface is called the "electrical double layer."

The electrical double layer capacitor, "SuperCapacitor," uses activated carbon as its solid part and aqueous solution of dilute sulfuric acid as its liquid part. Figure 1(a) shows the state in which activated carbon and dilute sulfuric acid are brought into contact, and Figure 1(b) shows the modeled state in which two pairs of the solid and liquid parts in Figure 1(a) are connected in series with both pairs sharing the same liquid part, and with an electrical field applied externally.

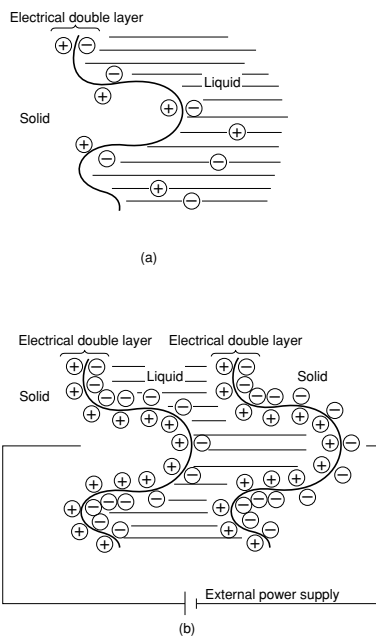

Fig. 1 Model Showing Basic Principle

Figure 2 shows a conceptual drawing of the basic structure of SuperCapacitor.

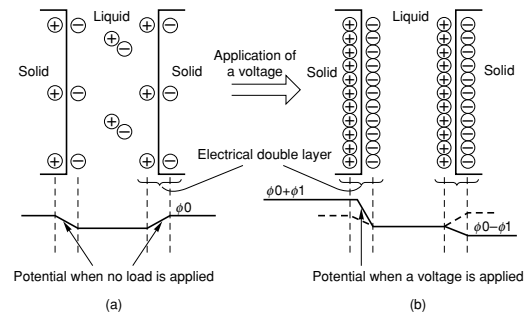

Fig. 2 Basic Structure of SuperCapacitor

Suppose  $\eta$  is the amount of unitary charge of the solid part,  $d$  is the dielectric constant of the medium (liquid part),  $\delta$  is the distance from the solid surface to the center of ions, and  $\psi$  is the potential of the double layer, then  $\eta$  is represented by expression (1).

$$\eta = \frac{d}{4\pi\delta} \times \psi \quad (1)$$

According to Helmholtz's theory, there is a potential gradient only in the electrical double layer, and their respective potential curves are as shown in Figures 2 (a) and 2 (b). In Figure 2(b), if  $\psi$  and  $\eta$ , when no load is applied, are  $\phi_0$  and  $\eta_0$ , respectively, then  $\eta_0$  is represented by expression (2).

$$\eta_0 = \frac{d}{4\pi\delta} \times \psi_0 \quad (2)$$

Then, if an external electrical field is applied, charge is accumulated on the boundary surface as shown in Figure 2 (b). At this time, suppose  $\psi_0$  becomes  $\psi_1$  and  $\eta_0$  becomes  $\eta_1$ , then  $\eta_1$  is represented by expression (3).

$$\eta_1 = \frac{d}{4\pi\delta} \times (2\psi_1 - \psi_0) \quad (3)$$

From expressions (2) and (3) above, expression (4) is found.

$$\eta_1 = 2\eta_0 \left( \frac{\psi_1}{\psi_0} \right) \times (\psi_1 > \psi_0) \quad (4)$$

That is, the external electrical field allows charge corresponding to  $\eta_1$  in expression (4) to accumulate in the electrical double layer. Here,  $\psi_0$  is on the order of several mV.



- All specifications in this catalog and production status of products are subject to change without notice. Prior to the purchase, please contact TOKIN for updated product data.
- Please request for a specification sheet for detailed product data prior to the purchase.
- Before using the product in this catalog, please read "Precautions" and other safety precautions listed in the printed version catalog.

According to an experiment using mercury for the electrode, an accumulated capacitance of 20 to 40  $\mu\text{F}/\text{cm}^2$  per unit area is obtained. Suppose the activated carbon electrode shows the same action as that of mercury, then activated carbon with a surface area of 1000  $\text{m}^2/\text{g}$  will produce a capacitance of 200 to 400 F/g. However, such a high capacitance is not actually obtained. It is our proprietary technology that made it possible to obtain a value very close to the above value by improving the quality of the activated carbon surface or increasing specific surface area, etc.

On the other hand, it is not possible in principle to apply a voltage higher than the decomposition voltage of an electrolyte based on the substance which makes up an electrical double layer capacitor. Therefore, it is necessary to have a structure of connecting capacitor base cells in series in order to obtain the desired breakdown voltage.

Figure 3 shows the basic structure (capacitor base cell) of a SuperCapacitor.

The electrical double layer phenomenon appears on the boundary surface between activated porous carbon powder (solid) and the electrolyte, dilute sulfuric acid (liquid). The separator (porous organic film) has a structure which prevents short-circuit between the positive and negative electrodes (activated carbon powder) and lets ions pass in the

electrolyte (dilute sulfuric acid). It also places a conductive current collecting electrode behind both electrodes (activated carbon powder) allowing a voltage to be applied to this capacitor base cell. In addition, it provides sealing rubber (mainly butyl rubber) at the electrode flank for sealing the electrolyte and isolating the conductive material. The amount of the electrolyte to be sealed into the capacitor base cell is equivalent to that needed for impregnation of the pores inside activated carbon and the porous organic film, and it is a very small amount.

The breakdown voltage of the capacitor base cell depends on the electrolysis voltage of the electrolyte. The electrolysis voltage depends on the water content in the dilute sulfuric acid, and it is approximately 1.2 V. Design of the breakdown voltage for the maximum operating voltage of 5.5 V is determined by connecting 5 or more sheets of capacitor base cells in series. (See Figure 4.)

A certain pressure is applied inside the package to stabilize electrical connection between the capacitor base cells, between activated carbon powder particles and between activated carbon powder and conductive current collecting electrodes.

Figures 5,6 and 7 show a cross section of a finished product of a SuperCapacitor.

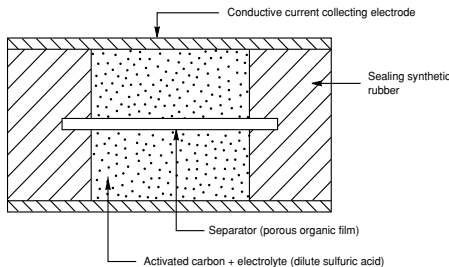

**Fig. 3 Capacitor with Basic Structure (Base Cell)**

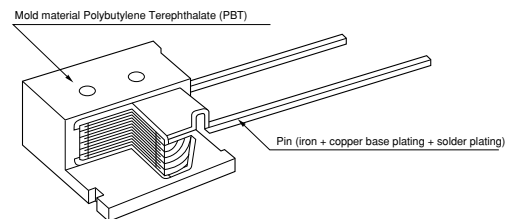

**Fig. 6 SuperCapacitor Resin Mold Type Structure (FM Series)**

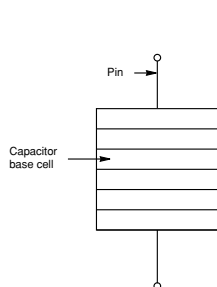

**Fig. 4 Assembly Schematic**

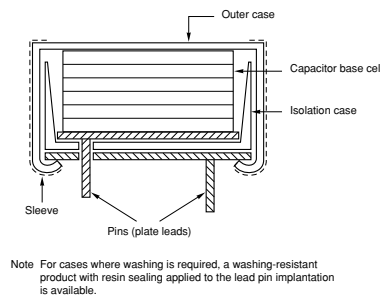

**Fig. 5 Cross Section SuperCapacitor Standalone Type Can Case**

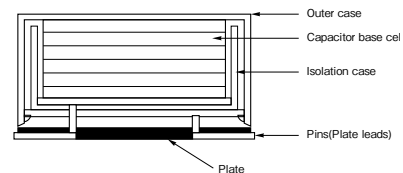

**Fig. 7 SuperCapacitor FC Series Structure**



- All specifications in this catalog and production status of products are subject to change without notice. Prior to the purchase, please contact TOKIN for updated product data.
- Please request for a specification sheet for detailed product data prior to the purchase.
- Before using the product in this catalog, please read "Precautions" and other safety precautions listed in the printed version catalog.

# 3

## PRODUCT LINE-UP FOR SuperCapacitor

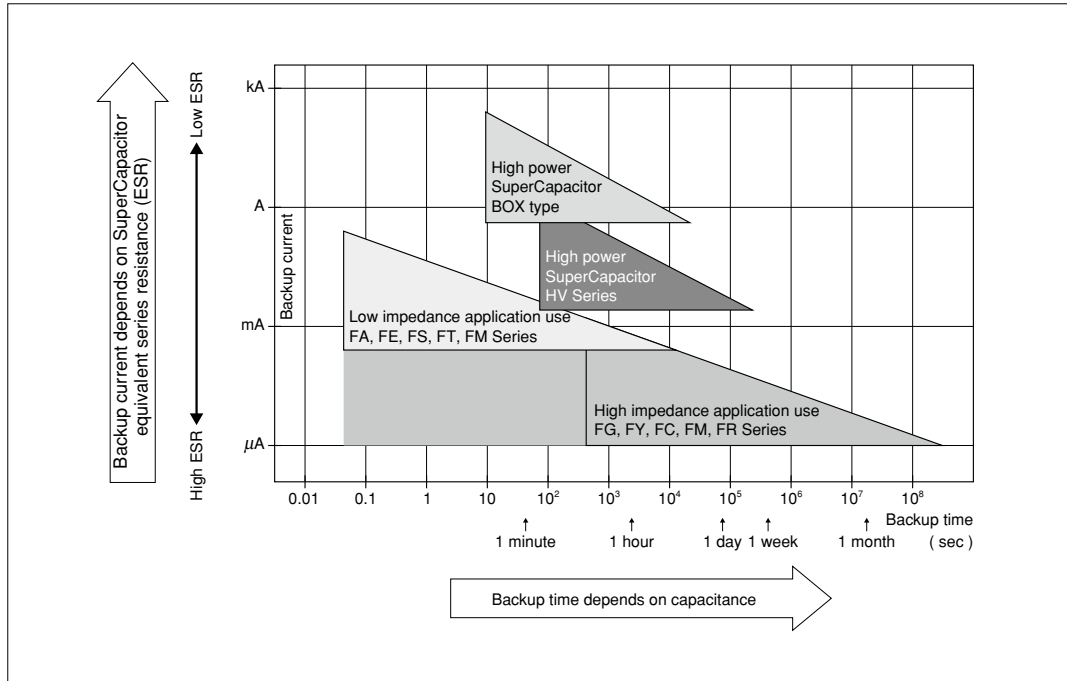

- All specifications in this catalog and production status of products are subject to change without notice. Prior to the purchase, please contact TOKIN for updated product data.
- Please request for a specification sheet for detailed product data prior to the purchase.
- Before using the product in this catalog, please read "Precautions" and other safety precautions listed in the printed version catalog.

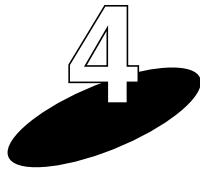

**FEATURES**

A SuperCapacitor has internal resistance greater than an aluminum electrolytic capacitor (several hundreds of m Ω to 100 Ω), and cannot be used in an AC circuit for ripple absorption applications, etc. Therefore, it is mainly used in a secondary battery for power supply backup in a DC circuit, etc.

The table below shows the features of a SuperCapacitor in comparison with an aluminum electrolytic capacitor for power supply backup and a secondary battery.

	Capacitor		Secondary Battery	
	SuperCapacitor	Aluminum Electrolytic Capacitor	Ni-Cd Battery	Lithium Secondary Battery
Backup capacity	○	△	◎	◎
Pollutive characteristic	-	-	Use of cadmium	-
Operating temperature range	-40 to 85 °C (FR.FT)	-55 to 105 °C	-20 to 60 °C	-20 to 50 °C
Charging time	A few seconds	A few seconds	A few hours	A few hours
Charging/discharging life	Unlimited (Note 1)	Unlimited (Note 1)	Approx. 500 times	Approx. 500 to 1000 times
Restrictions on charging/discharging	No	No	Yes	Yes
Flow soldering	Applicable	Applicable	Not applicable	Not applicable
Automatic mounting	Applicable (FC, FM Series)	Applicable	Not applicable	Not applicable
Failure mode	Open	Shorted	Shorted	Shorted
Safety	Gas emission (Note 2)	Heating, explosion	Leakage, explosion	Leakage, ignition, explosion

- Notes
1. Aluminum electrolytic capacitors and SuperCapacitors have a limited service life. However, within the lifetime of device set that SuperCapacitor has been built-in, these are designed to last long enough if used under appropriate conditions.
  2. Water vapor generated from the water in the electrolyte, gradually leak out in a form of gas and are not dangerous. However, if unusual voltage such as greater than the maximum operating voltage is applied suddenly, a leakage of liquid or explosion may result.



- All specifications in this catalog and production status of products are subject to change without notice. Prior to the purchase, please contact TOKIN for updated product data.
- Please request for a specification sheet for detailed product data prior to the purchase.
- Before using the product in this catalog, please read "Precautions" and other safety precautions listed in the printed version catalog.



# 5

## MANUFACTURING AND RELIABILITY & QUALITY CONTROL

### 5.1 Manufacturing Process

Figure 7 shows an outline of the manufacturing process of a SuperCapacitor. The manufacturing process can be largely divided into the manufacturing process of capacitor base cells and the product assembly process.

#### (1) Manufacturing process of capacitor base cells

A mixture of activated carbon and dilute sulfuric acid is formed on the conductive current collecting electrodes, which the electrolyte hardly penetrates, and this is used as an electrode. Two pairs of these electrodes are prepared, and a porous organic film separator and sealing material are inserted between these pairs, compacted in the periphery, and completely sealed. In this way, capacitor base cells are manufactured.

#### (2) Product assembly process

The above capacitor base cells are placed one atop another. For the can case type, they are accommodated in a metal case and caulked. For the resin mold type, they are packaged in mold.

### 5.2 Process & Quality Control

The SuperCapacitor is controlled and manufactured under a strict control and environmental protection system based on ISO9000 and ISO14000. Figure 7 shows the contents of the process & quality control of a SuperCapacitor.



- All specifications in this catalog and production status of products are subject to change without notice. Prior to the purchase, please contact TOKIN for updated product data.
- Please request for a specification sheet for detailed product data prior to the purchase.
- Before using the product in this catalog, please read "Precautions" and other safety precautions listed in the printed version catalog.

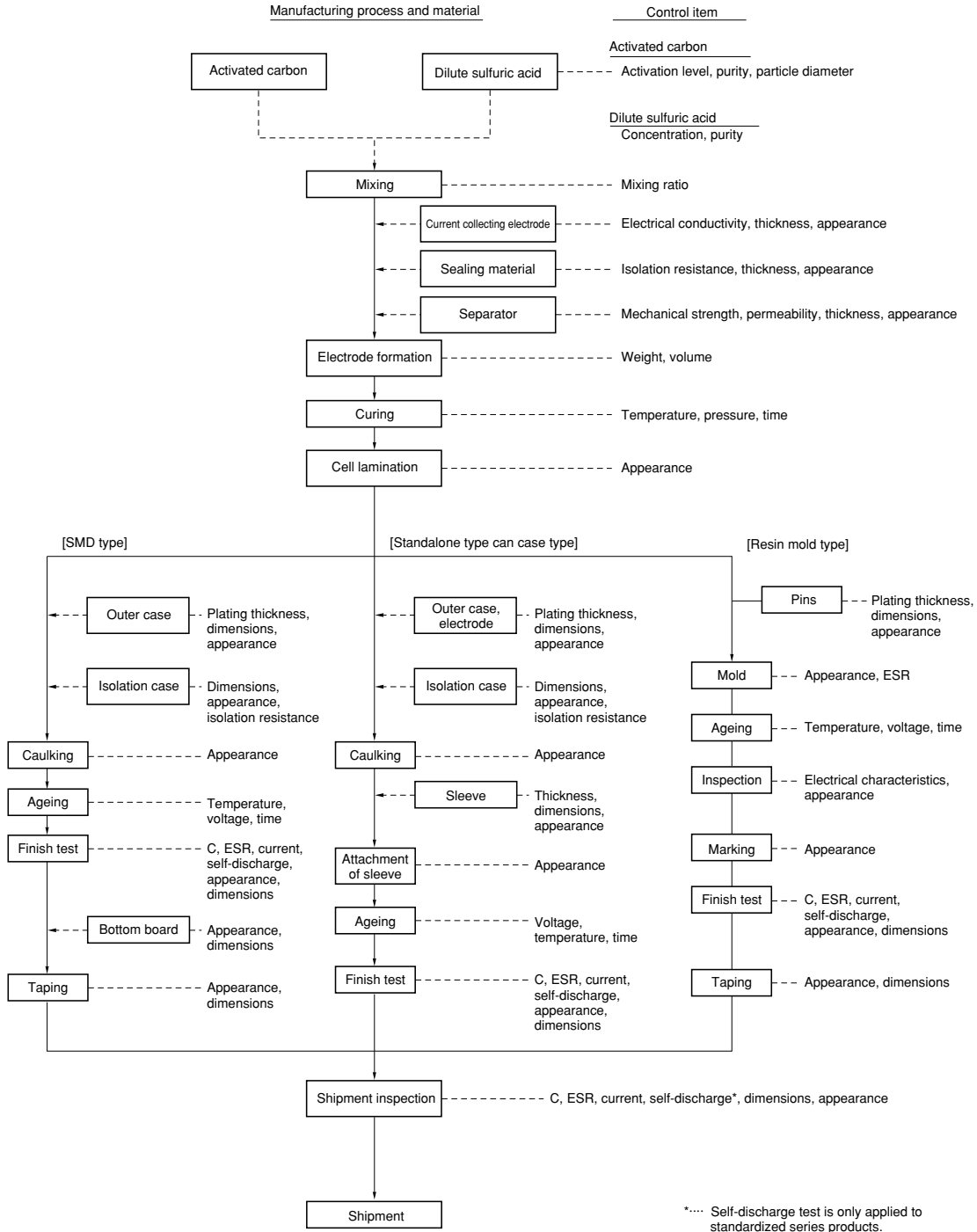

**Manufacturing Process and Process & Quality**



- All specifications in this catalog and production status of products are subject to change without notice. Prior to the purchase, please contact TOKIN for updated product data.
- Please request for a specification sheet for detailed product data prior to the purchase.
- Before using the product in this catalog, please read "Precautions" and other safety precautions listed in the printed version catalog.

# 6

## PERFORMANCE

### 6.1 Initial Performance

#### (1) Capacitance (Cap)

Table 1 shows typical capacitance values of each product.

**Table 1. Initial Characteristics**  
Values in this table are average values.

Product Name	Capacitance C (F)	Equivalent Series Resistance ESR ( $\Omega$ )	DC Resistance R ( $\Omega$ )
FCS0H473ZF	0.047	15	25
104ZF	0.10	10	17
224ZF	0.22	10	17
FCS0V104ZF	0.10	15	25
224ZF	0.22	10	17
474ZF	0.47	10	17
* FC0H473ZF	0.047	13	22
* 104ZF	0.10	12	17
* 224ZF	0.22	8	14
* 474ZF	0.47	5	8.2
* 105ZF	1.0	4	6
* FC0V104ZF	0.1	18	21
* 224ZF	0.22	11	12
* 474ZF	0.47	11	15
FMOH103ZF	0.012	30	65
223ZF	0.022	18	33
473ZF	0.047	12	26
104ZF	0.10	12	32
* 224ZF	0.22	8	12
FME0H223ZF	0.022	14	20
473ZF	0.047	8.5	14
FMR0H473ZF	0.047	11	19
FMC0H473ZF	0.047	12	16
104ZF	0.10	9	12
* 334ZF	0.33	5	10
FG0H103ZF	0.01	82	94
223ZF	0.022	23	31
473ZF	0.047	23	29
104ZF	0.10	12	16
224ZF	0.22	10	15
474ZF	0.47	14	26
105ZF	1.0	7.6	14
225ZF	2.2	3.2	7
475ZF	4.7	1.2	3.2
* FGH0H104ZF	0.1	12	20
* 224ZF	0.22	18	36
* 474ZF	0.47	7	13
* 105ZF	1.0	3	6
FT0H104ZF	0.10	13	23
224ZF	0.22	8.5	16
474ZF	0.46	3.6	5.4
105ZF	1.0	1.8	2.9
225ZF	2.19	1.2	2.1
335ZF	3.3	0.8	1.3
565ZF	5.8	0.4	0.8
FS0H223ZF	0.028	24	51
473ZF	0.047	10	18
104ZF	0.10	7.5	11
224ZF	0.24	5.5	9
474ZF	0.54	2.5	4.2
105ZF	1.22	1.8	2.9
FS1A474ZF	0.47	1.7	3.4
105ZF	1.0	2.5	5.0
FS1B105ZF	1.0	2.7 (1.2)	5.0
505ZF	5.0	0.9	2.0
FR0H223ZF	0.022	38	72
473ZF	0.050	24	50
104ZF	0.12	18	38
224ZF	0.28	26	55
474ZF	0.6	18	38
105ZF	1.15	9	18

Product Name	Capacitance C (F)	Equivalent Series Resistance ESR ( $\Omega$ )	DC Resistance R ( $\Omega$ )
FYD0H223ZF	0.026	80	168
473ZF	0.047	55	113
104ZF	0.095	24	45
224ZF	0.21	17	36
474ZF	0.45	13	24
105ZF	0.98	6.5	11
145ZF	1.3	8.2	18
225ZF	2.3	4.2	9.2
FYH0H223ZF	0.028	64	131
473ZF	0.047	35	66
104ZF	0.11	20	38
224ZF	0.22	20	42
474ZF	0.55	7.5	14
105ZF	1.15	4.5	8
FYLOH103ZF	0.012	80	155
223ZF	0.022	25	48
473ZF	0.047	20	38
FE0H473ZF	0.052	10	16
104ZF	0.12	5	8
224ZF	0.28	2.5	4.4
474ZF	0.62	0.9	2.2
105ZF	0.98	0.7	1.2
155ZF	1.68	0.3	0.6
FA0H473ZF	0.052	10	17
104ZF	0.12	5	8
224ZF	0.28	2.5	4.5
474ZF	0.62	1	2.2
105ZF	1.0	0.6	1.1
FA1A223ZF	0.024	16	33
104ZF	0.15	3.8	6.4
224ZF	0.33	1.8	3.1
474ZF	0.52	1	2.1

\* Capacitance values according to the constant current discharge method

Capacitance of the SuperCapacitor is measured according to the constant-resistance charge method or constant current discharge method.

In Constant resistance charge method, Capacitance (F) of the capacitor is calculated by measuring the time constant ( $\tau$ ) which represents the charge characteristic when a resistor is connected to the capacitor in series and a DC voltage is applied.

(To do this, it is necessary to short-circuit between the capacitor pins for 30 minutes or more to reduce the potential sufficiently.



- All specifications in this catalog and production status of products are subject to change without notice. Prior to the purchase, please contact TOKIN for updated product data.
- Please request for a specification sheet for detailed product data prior to the purchase.
- Before using the product in this catalog, please read "Precautions" and other safety precautions listed in the printed version catalog.

Capacitance: Calculated from  $(F) = \frac{\tau}{RC}$  (5)

$\tau$  : Charge time until 0.632E<sub>0</sub> (V<sub>c</sub>) (sec)

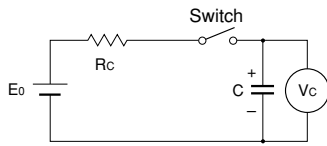

If measured according to competitors' constant current, discharge and charge measurement methods, the specified current values are smaller than those specified by us and therefore they are apparently 1.3 to 1.5 times the capacitance values measured by our measurement method. Therefore, the backup capability of the same rated product as those of competitors is 1.3 to 1.5 times that of competitors.

Refer to page 20 for capacitance values according to the constant current discharge method.

The capacitance values measured using the fixed resistor charge method and the constant current discharge method are both shown in the standard ratings.

Figure 8 shows capacitance values when the discharge current is changed. When the discharge current is small, the capacitance value is relatively large.

In the method of measuring capacitance for normal backup applications, the discharge system is considered to reflect more precisely the actual situation. However, in order to simplify measurement, the charge system which discharges a relatively large current is used.

Figure 9 shows changes in capacitance due to temperature variations. The temperature changes in proportion to the capacitance, and the higher the temperature is, the greater the capacitance becomes.

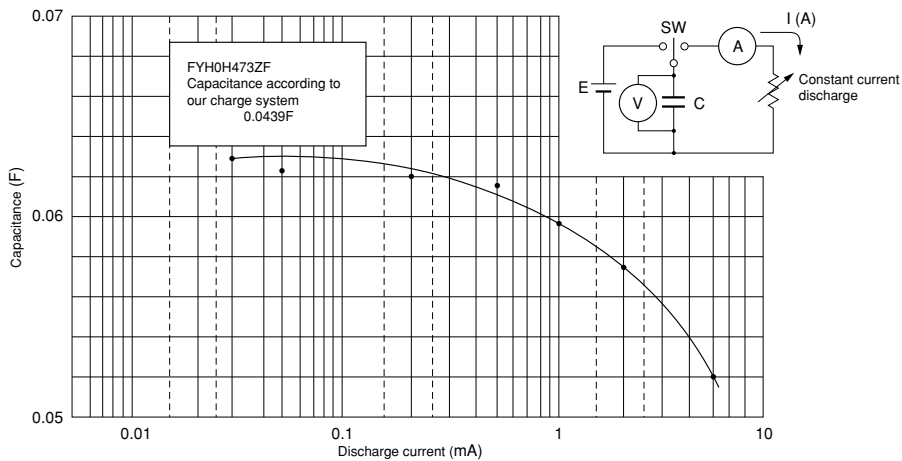

**Fig. 8 Capacitance Values vs. Discharge Current Values**

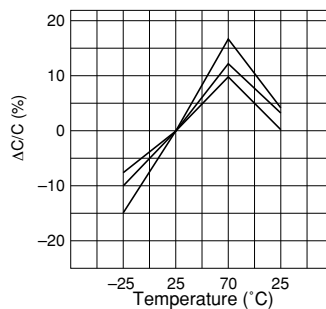

**Fig. 9 Capacitance Change (Condition: -25 °C □ 25 °C □ 70 °C □ 25 °C □ , n = 10)**



- All specifications in this catalog and production status of products are subject to change without notice. Prior to the purchase, please contact TOKIN for updated product data.
- Please request for a specification sheet for detailed product data prior to the purchase.
- Before using the product in this catalog, please read "Precautions" and other safety precautions listed in the printed version catalog.

**(2) Equivalent series resistance (ESR)**

Table 1 shows average typical values of equivalent series resistance for each product.

The equivalent series resistance of a SuperCapacitor is measured as follows: A sine wave oscillator of AC 1 kHz is used to pour an AC current of 10 mA into a capacitor (C) and the voltage between both capacitor ends ( $V_C$ ) is measured, then the equivalent series resistance of a SuperCapacitor is calculated from expression (6).

$$\text{Equivalent series resistance (ESR)} = \frac{V_C}{0.01} \quad (6)$$

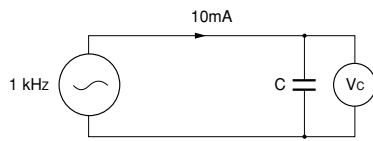

Figure 10 shows ESR values when the frequency is changed. The lower the frequency is, the greater ESR becomes.

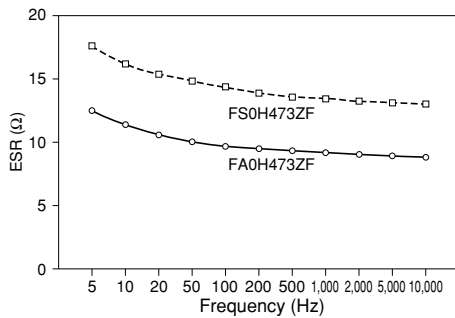

Fig. 10 Frequency Dependency of ESR

Figure 11 shows ESR changes due to temperature variation. The lower the temperature is, the greater ESR becomes.

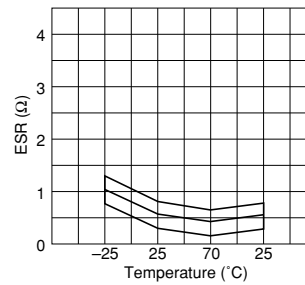

Fig. 11 Temperature Dependency of ESR

**(3) Series resistance**

Normally, a SuperCapacitor is used for DC charge/discharge. Table 1 shows typical average values of DC resistance (internal resistance) of a SuperCapacitor actually measured using a DC current.

Figure 12 shows voltage drops when the discharge current is changed.

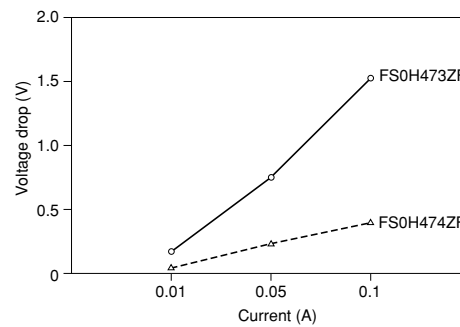

Fig. 12 Voltage Drop



- All specifications in this catalog and production status of products are subject to change without notice. Prior to the purchase, please contact TOKIN for updated product data.
- Please request for a specification sheet for detailed product data prior to the purchase.
- Before using the product in this catalog, please read "Precautions" and other safety precautions listed in the printed version catalog.

**(4) Current**

The current of a SuperCapacitor is calculated from expression (7) by applying a voltage to the capacitor [C] and measuring the voltage between both DC resistor ends 30 minutes later. (The voltage is applied after both ends of the capacitor are shorted for 30 minutes or more to reduce the potential sufficiently.)

$$\text{Current} = \frac{V_R}{R_C} \times 10^3 \text{ (mA)} \quad (7)$$

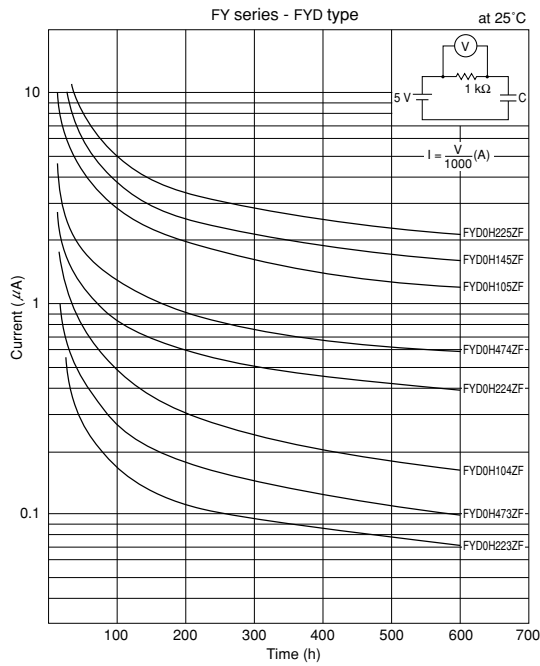

**Fig. 13 Multi-Hour Current Characteristic**

Figure 13 shows changes in the electrode when a voltage is continuously applied to the capacitor. The main current component after 30 minutes of voltage application is an absorption current. It takes several tens to hundreds of hours for a leakage current to become the main component as the absorption current reduces.

Figure 14 shows the multi-hour current characteristic when the ambient temperature is changed. The higher the temperature is, the greater the current becomes.

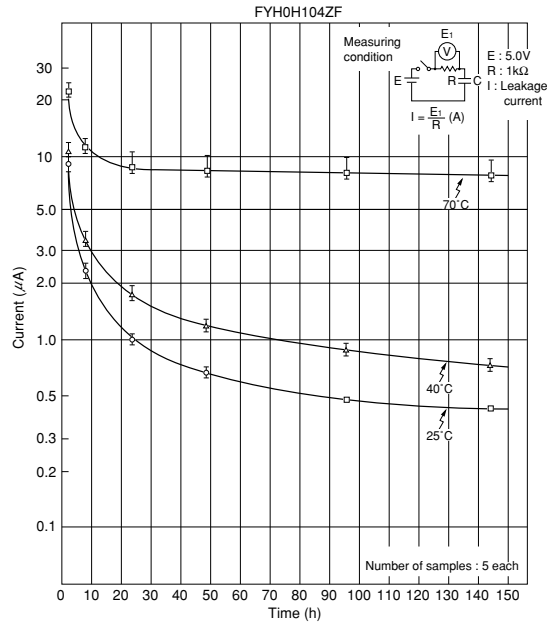

**Fig. 14 Temperature Dependency of Multi-Hour Current**



- All specifications in this catalog and production status of products are subject to change without notice. Prior to the purchase, please contact TOKIN for updated product data.
- Please request for a specification sheet for detailed product data prior to the purchase.
- Before using the product in this catalog, please read "Precautions" and other safety precautions listed in the printed version catalog.

**(5) Self-discharge characteristic**

When applying a voltage to a SuperCapacitor and then releasing the voltage between both pins, the rate of decrease of the voltage between both pins is defined as the self-discharge characteristic.

The self-discharge characteristic of a SuperCapacitor is obtained by charging 5.0 VDC (charge protection resistance: 0 Ω) into the capacitor for 24 hours, then releasing the voltage between both pins, leaving the capacitor at an ambient temperature of 25 °C or below and relative humidity of 70%RH for 24 hours, and then measuring the voltage remaining between both pins.

Figure 15 shows the self-discharge characteristic of a sample which has been left at a normal temperature.

Figure 16 shows deterioration of the self-discharge characteristic of a SuperCapacitor which has been left at a high temperature of 50 °C.

\* For backup applications, which may be affected by the self-discharge characteristic for many hours on the order of μA, FG, FM, FC, FR and FY Series in which the self-discharge characteristic (residual voltage value) is guaranteed, are most suitable.

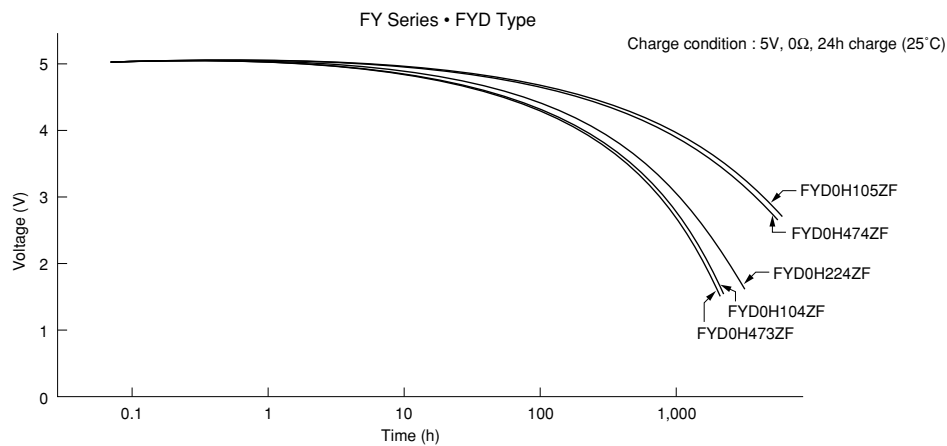

**Fig. 15 Self-Discharge Characteristic**

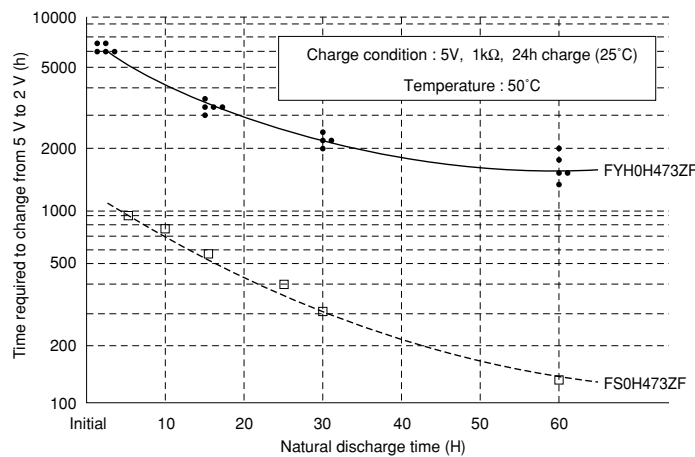

**Fig. 16 Change of Self-Discharge Characteristic by Natural Discharge**



- All specifications in this catalog and production status of products are subject to change without notice. Prior to the purchase, please contact TOKIN for updated product data.
- Please request for a specification sheet for detailed product data prior to the purchase.
- Before using the product in this catalog, please read "Precautions" and other safety precautions listed in the printed version catalog.

**(6) Resistance discharge characteristic**

① Influence of charge time on the discharge characteristic  
 Figures 17 and 18 show resistance discharge characteristics of the FS, FY (FYD type) Series 5.5 V/0.047F products. There is no significant difference between the series.

However, there is a difference in the backup characteristic depending on charge time.

The longer the charge time is, the longer the possible backup time is.

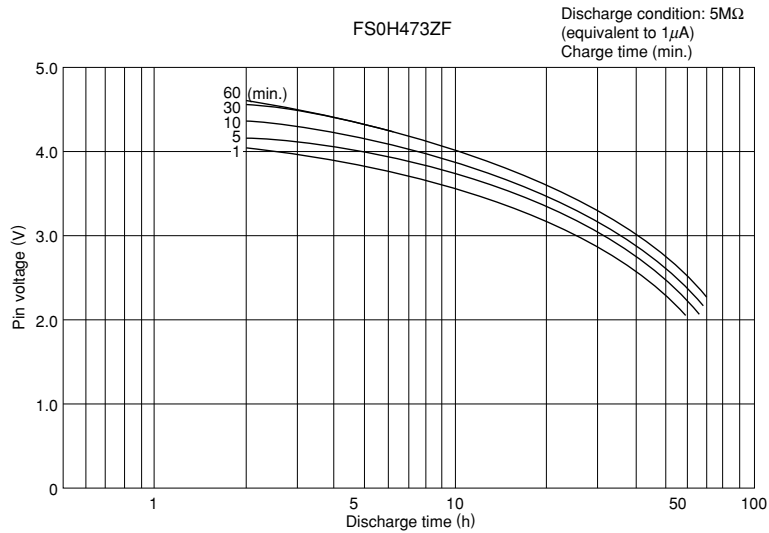

**Fig. 17 Constant-Resistance Discharge Characteristic (Charge Time Dependency)**

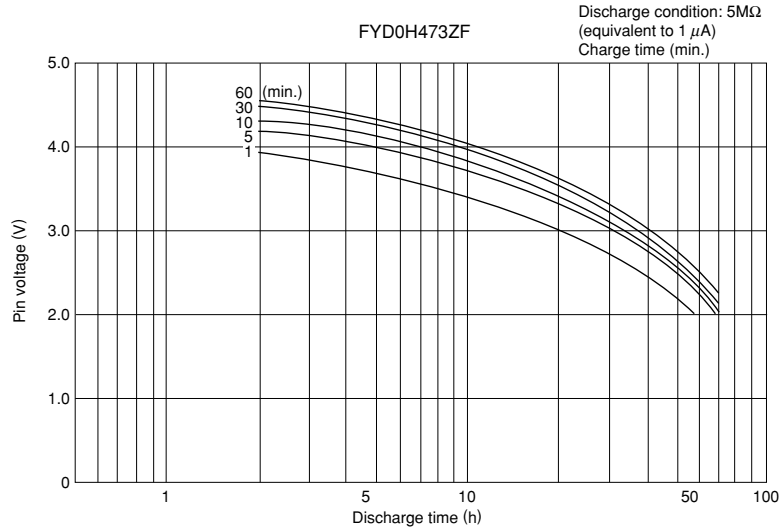

**Fig. 18 Constant-Resistance Discharge Characteristic (Charge Time Dependency)**



- All specifications in this catalog and production status of products are subject to change without notice. Prior to the purchase, please contact TOKIN for updated product data.
- Please request for a specification sheet for detailed product data prior to the purchase.
- Before using the product in this catalog, please read "Precautions" and other safety precautions listed in the printed version catalog.



② Influence of ambient temperature on the resistance discharge characteristic

Figures 19 to 21 show the resistance discharge characteristics when the ambient temperature is changed. There is no great difference of the discharge time up to approximately 40 °C,

but the discharge time decreases drastically at a higher temperature. Factors determining the discharge characteristic are storage dependency of capacitance and temperature dependency of leakage current.

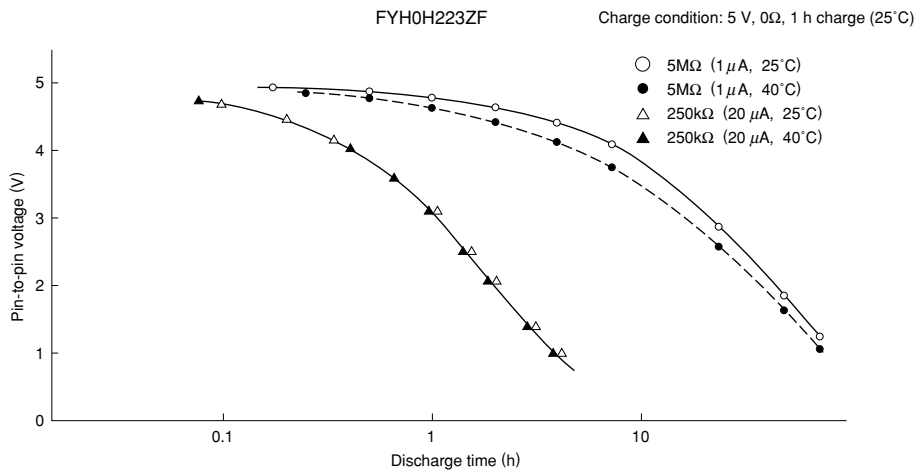

**Fig. 19 Resistance Discharge Characteristic (Temperature Dependency)**

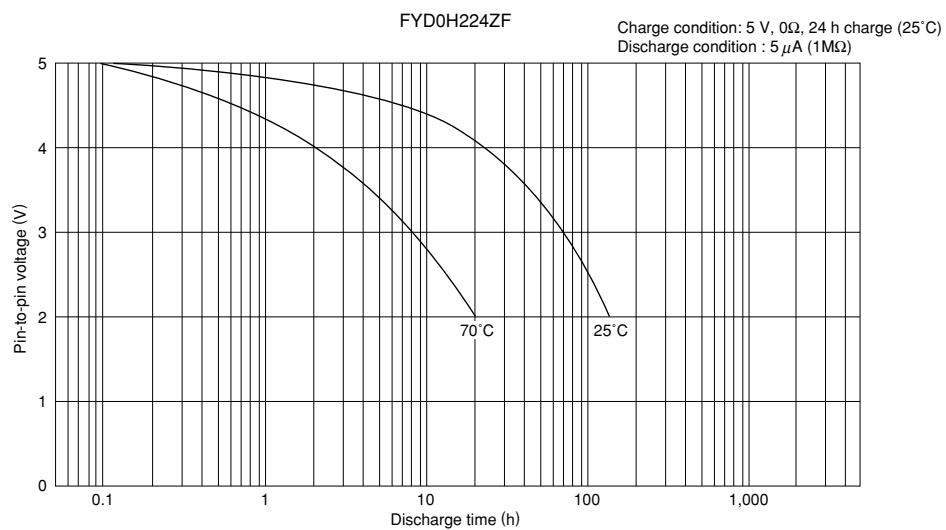

**Fig. 20 Resistance Discharge Characteristic (Temperature Dependency)**



- All specifications in this catalog and production status of products are subject to change without notice. Prior to the purchase, please contact TOKIN for updated product data.
- Please request for a specification sheet for detailed product data prior to the purchase.
- Before using the product in this catalog, please read "Precautions" and other safety precautions listed in the printed version catalog.

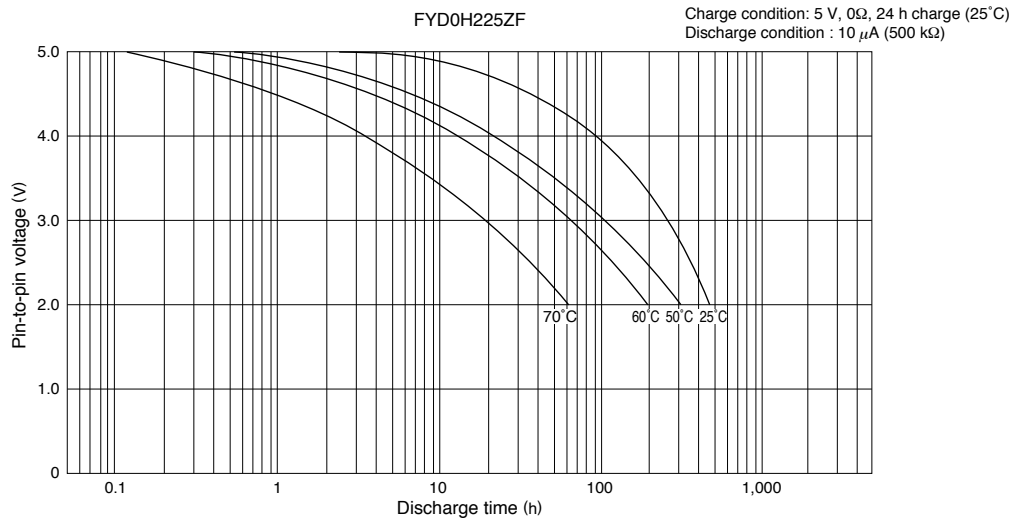
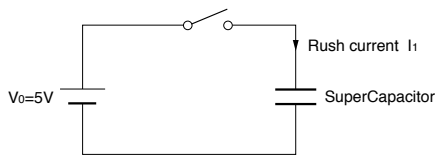

**Fig. 21 Resistance Discharge Characteristic (Temperature Dependency)**

**(7) Rush current (maximum current during charging)**

A rush current occurs when a voltage of 5 V is applied and there is no series protection resistor. Its measurement circuit is shown in Figure 22.

Generally, the greater the capacitance and the greater the diameter of a product is, the smaller its DC resistance is and so the greater the rush current in the same series is.



**Fig. 22 Test Conditions for Rush Current**

Figure 23 shows temporal changes in pin-to-pin voltage V and charge current I when a voltage is applied to the FA0H105ZF (5.5 V/1F).

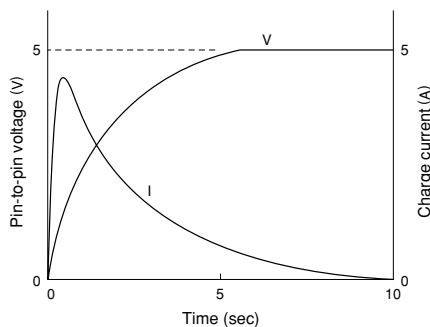

**Fig. 23 Charge Characteristic**

The FS, FT, FME, FA and FE series are designed to have an equivalent series resistance 1 digit smaller than other series. Care is required when designing peripheral circuits because application of a voltage causes a rush current to flow that is greater than other series.

Especially, if a current exceeding the maximum supply current of the power supply flows, the protection circuit of the power supply may malfunction or shut down. In such a case, it is necessary to insert a series resistor to protect the power supply.

The peak value of rush current I is calculated from expression (8).

$$I = \frac{E}{R} \text{ [A]} \quad (8)$$

E: Voltage applied (V)

R: SuperCapacitor DC resistance (Ω)

Note If there is a series protection resistor, add it to R.

Table 1 shows DC resistance R which is calculated from a voltage drop during discharging of a representative product. DC resistance of a SuperCapacitor shows approximately 1.5 times the actual ESR (at 1 kHz) value.



- All specifications in this catalog and production status of products are subject to change without notice. Prior to the purchase, please contact TOKIN for updated product data.
- Please request for a specification sheet for detailed product data prior to the purchase.
- Before using the product in this catalog, please read "Precautions" and other safety precautions listed in the printed version catalog.



# CHARACTERISTIC MEASURING METHOD

## (1) Capacitance

### 1. Measuring capacitance using the fixed resistor charge method

The capacitance of SuperCapacitors can not be measured using the same methods used to measure ordinary capacitors because of their large capacitance and large equivalent series resistance.

For this reason the capacitance is calculated by charging and discharging the capacitor with a direct current, in the same way that the capacity of batteries is measured.

Capacitance is calculated from expression (9) by measuring the charge time constant ( $\tau$ ) of the capacitor (C). Prior to measurement, short between both pins of the capacitor for 30 minutes or more to let it discharge. In addition, follow the indication of the product when determining the polarity of the capacitor during charging.

$$\text{Capacitance: } C = \frac{\tau}{R_c} \text{ (F)} \quad (9)$$

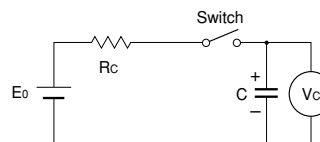

- $E_0$  : 3.0 (V) ... Product with maximum operating voltage 3.5 V
- : 5.0 (V) ... Product with maximum operating voltage 5.5 V
- : 6.0 (V) ... Product with maximum operating voltage 6.5 V
- : 10.0 (V) ... Product with maximum operating voltage 11 V
- : 12.0 (V) ... Product with maximum operating voltage 12 V
- $\tau$  : Time from start of charging until  $V_c$  becomes  $0.632E_0$  (V) (sec)
- $R_c$  : See table below ( $\Omega$ ).

	FA	FE	FS	FY		FR	FM, FME FMR	FMC	FG FGR	FGH	FT	FC FCS
				FYD	FYH							
0.010F	-	-	-	-	-	-	5000 $\Omega$	-	5000 $\Omega$	-	-	-
0.022F	1000 $\Omega$	-	1000 $\Omega$	2000 $\Omega$	2000 $\Omega$	2000 $\Omega$	2000 $\Omega$	-	2000 $\Omega$	-	-	Discharge
0.033F	-	-	-	-	-	-	Discharge	-	-	-	-	-
0.043F	-	-	-	-	-	-	-	-	-	-	-	Discharge
0.047F	1000 $\Omega$	1000 $\Omega$	1000 $\Omega$	2000 $\Omega$	1000 $\Omega$	1000 $\Omega$	2000 $\Omega$	1000 $\Omega$	2000 $\Omega$	-	-	-
0.068F	-	-	-	-	-	-	-	-	-	-	-	Discharge
0.10F	510 $\Omega$	510 $\Omega$	510 $\Omega$	1000 $\Omega$	510 $\Omega$	1000 $\Omega$	1000 $\Omega$	1000 $\Omega$	1000 $\Omega$	Discharge	510 $\Omega$	Discharge
0.22F	200 $\Omega$	200 $\Omega$	200 $\Omega$	510 $\Omega$	510 $\Omega$	510 $\Omega$	0H: Discharge 0V: 1000 $\Omega$	-	1000 $\Omega$	Discharge	200 $\Omega$	Discharge
0.33F	-	-	-	-	-	-	-	Discharge	-	-	-	-
0.47F	100 $\Omega$	100 $\Omega$	100 $\Omega$	200 $\Omega$	200 $\Omega$	200 $\Omega$	-	-	1000 $\Omega$	Discharge	100 $\Omega$	Discharge
1.0F	51 $\Omega$	51 $\Omega$	100 $\Omega$	100 $\Omega$	100 $\Omega$	100 $\Omega$	-	-	510 $\Omega$	Discharge	100 $\Omega$	Discharge
1.4F	-	-	-	200 $\Omega$	-	-	-	-	-	-	-	-
1.5F	-	51 $\Omega$	-	-	-	-	-	-	510 $\Omega$	-	-	-
2.2F	-	-	-	100 $\Omega$	-	-	-	-	200 $\Omega$	-	51 $\Omega$	-
3.3F	-	-	-	-	-	-	-	-	-	-	51 $\Omega$	-
4.7F	-	-	-	-	-	-	-	-	100 $\Omega$	-	-	-
5.0F	-	-	100 $\Omega$	-	-	-	-	-	-	-	-	-
5.6F	-	-	-	-	-	-	-	-	-	-	20 $\Omega$	-

\* Capacitance values according to the constant current discharge method.



- All specifications in this catalog and production status of products are subject to change without notice. Prior to the purchase, please contact TOKIN for updated product data.
- Please request for a specification sheet for detailed product data prior to the purchase.
- Before using the product in this catalog, please read "Precautions" and other safety precautions listed in the printed version catalog.

**2. Measuring capacitance using the constant current discharge method**

**(0H: 5.5V products)**

Once the pin to pin voltage of the capacitor in the circuit below has reached 5.5V, charging is continued for another 30 minutes <sup>(Note 1)</sup>.

Then, a constant current-load device is used to discharge the capacitor at a current of 0.22 mA <sup>(Note 2)</sup>, and the time for the terminal voltage to fall from 3.0V to 2.5V is measured. This value is used in the equation below to calculate the capacitance.

**Note 1:** Products with 1.0F or more capacitance should be charged for 60 minutes.

**Note 2:** The current value during discharge is 1 mA per 1F.

$$\text{Capacitance : } C = \frac{I \times (T_2 - T_1)}{V_1 - V_2} \text{ (F)}$$

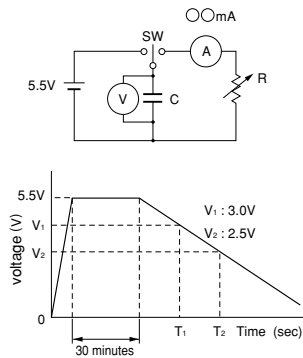

**(0V: 3.5V products)**

Once the pin to pin voltage of the capacitor in the circuit below has reached 3.5V, charging is continued for another 30 minutes <sup>(Note 1)</sup>.

Then, a constant current-load device is used to discharge the capacitor at a current of 0.22 mA <sup>(Note 2)</sup>, and the time for the terminal voltage to fall from 1.8V to 1.5V is measured. This value is used in the equation below to calculate the capacitance.

**Note 1:** Products with 1.0F or more capacitance should be charged for 60 minutes.

**Note 2:** The current value during discharge is 1 mA per 1F.

$$\text{Capacitance : } C = \frac{I \times (T_2 - T_1)}{V_1 - V_2} \text{ (F)}$$

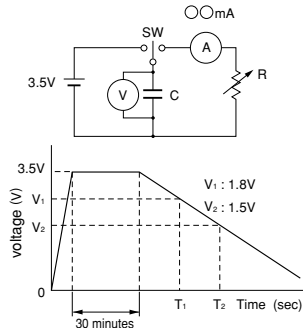

**(2) Equivalent series resistance (ESR)**

ESR is calculated from expression (10) by using a 1 kHz oscillator, pouring an AC current of 10 mA and measuring the voltage (V<sub>C</sub>) between both ends of the capacitor.

$$\text{Equivalent series resistance : } ESR = \frac{V_C}{0.01} \text{ (}\Omega\text{)} \quad (10)$$

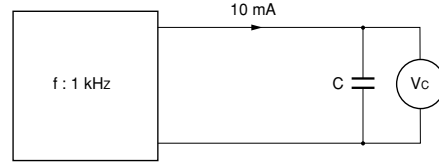

**(3) Current (30-minute value)**

The current value is calculated from expression (11) by applying a voltage to the capacitor (C), and measuring the voltage (V<sub>R</sub>) between both ends of the series resistor (R<sub>C</sub>) 30 minutes later. Prior to measurement, short between both pins of the capacitor for 30 minutes or more to let it discharge. Follow the indication of the product when determining the polarity of the capacitor during charging.

$$\text{Current : } I = \frac{V_R}{R_C} \times 10^3 \text{ (mA)} \quad (11)$$

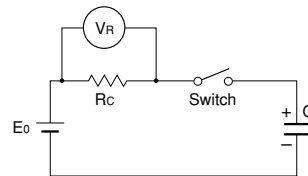

E<sub>0</sub>: Conforms to E<sub>0</sub> of capacitance measuring condition.

R<sub>C</sub>: 0.01 to 0.056F : 1 k Ω

0.1 to 0.47F : 100 Ω

1 to 2.2F : 10 Ω

FS Series 11 Vdc, 12 Vdc products

0.47F to 1.0F : 100 Ω

5.0F : 10 Ω

FG Series

1.0F to 4.7F : 10 Ω

FT Series

1.0F to 5.6F : 10 Ω

**(4) Self-discharge characteristic**

**(except FA, FE, FS, FT, FME, FML series, and 3.5 V and 6.5 V product)**

The self-discharge characteristic is measured by charging a voltage of 5.0 VDC (charge protection resistance: 0 Ω) according to the capacitor polarity for 24 hours, then releasing between the pins for 24 hours and measuring the pin-to-pin voltage.

This test should be carried out in an environment with an ambient temperature of 25 °C or below and relative humidity of 70%RH or below.



● All specifications in this catalog and production status of products are subject to change without notice. Prior to the purchase, please contact TOKIN for updated product data.  
● Please request for a specification sheet for detailed product data prior to the purchase.  
● Before using the product in this catalog, please read "Precautions" and other safety precautions listed in the printed version catalog.

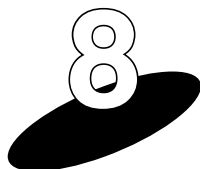

## SELECTION GUIDE

### 8.1 Calculating Backup Time

#### (1) When backup current is 1 mA or greater

(FS, FT, FME, FE, FA Series is most suitable.)

An approximate backup time can be calculated from expression (12).

$$T = \frac{C \times (V_0 - V_1 - V_{drop})}{I} \text{ (sec)} \quad (12)$$

- C : SuperCapacitor capacitance (F)
- V<sub>0</sub> : Voltage charged in SuperCapacitor (V)
- V<sub>drop</sub> : Voltage drop by DC resistance in SuperCapacitor (V)
- V<sub>1</sub> : Minimum required voltage for backup circuit (V)
- I : Backup current (A)

The voltage drop is determined by the DC resistance and backup current of the SuperCapacitor.

Table 1 shows DC resistance values (typical values) of each product.

An approximate voltage drop V<sub>drop</sub> can be calculated from expression (13).

$$V_{drop} = R_i I \text{ (V)} \quad (13)$$

- R<sub>i</sub> : DC resistance of SuperCapacitor (Ω)
- I : Backup current (A)

#### (2) When backup current is 1 mA or below

(FG, FM, FC, FR, FY series is most suitable.)

There is no particularly great potential drop. The available backup time is calculated from the constant-resistance discharge characteristic obtained by converting the backup current to a constant-resistance load.

For the constant-resistance discharge characteristic when the backup current value is converted to a constant-resistance load, see the each Series datasheet.

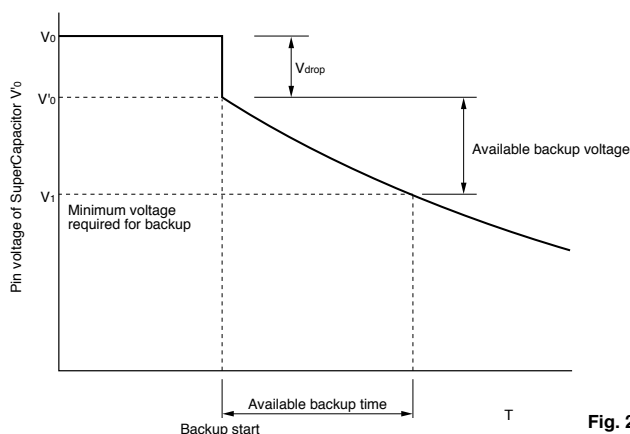

Fig. 24 Voltage Waveform during Backup



- All specifications in this catalog and production status of products are subject to change without notice. Prior to the purchase, please contact TOKIN for updated product data.
- Please request for a specification sheet for detailed product data prior to the purchase.
- Before using the product in this catalog, please read "Precautions" and other safety precautions listed in the printed version catalog.

**8.2 Leakage Current**

This indicates the charge current measured from the pin-to-pin voltage of the charge resistor when the SuperCapacitor is charged for many hours. The charge current decreases as the time passes by. Continuing charging comes to a point where this charge current will not decrease any more but remains constant (Figures 25 to 34).

This is defined as the leakage current.

In addition, the leakage current generally changes in proportion to capacitance.

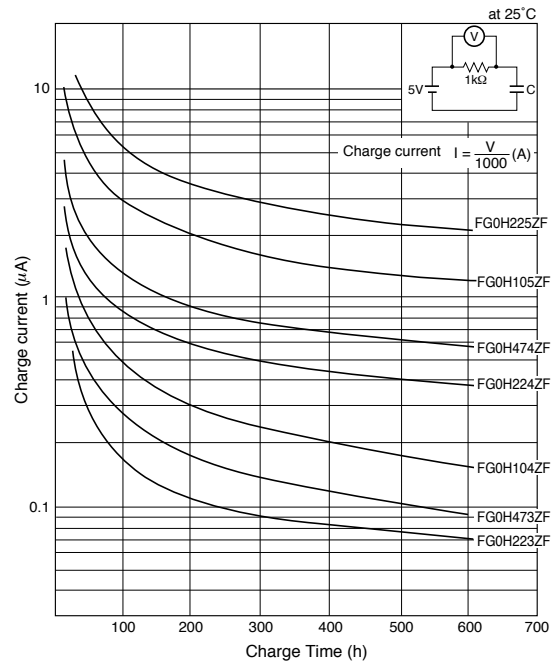

**Fig. 25 Charge Characteristic over Many Hours: FG Series**

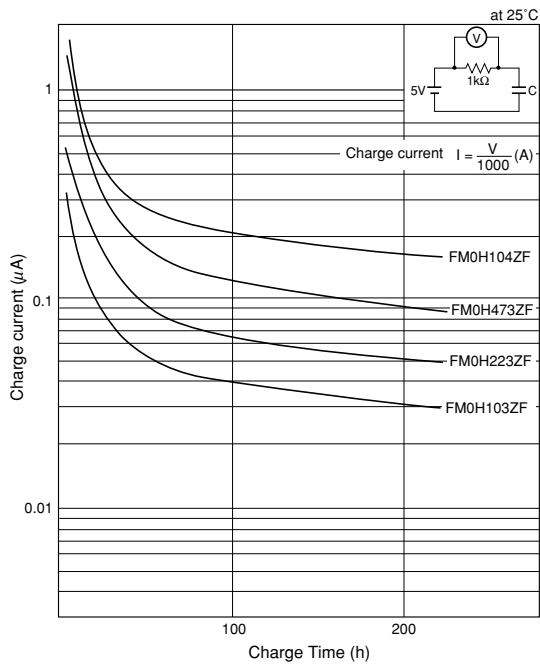

**Fig. 26 Charge Characteristic over Many Hours: FM Series**

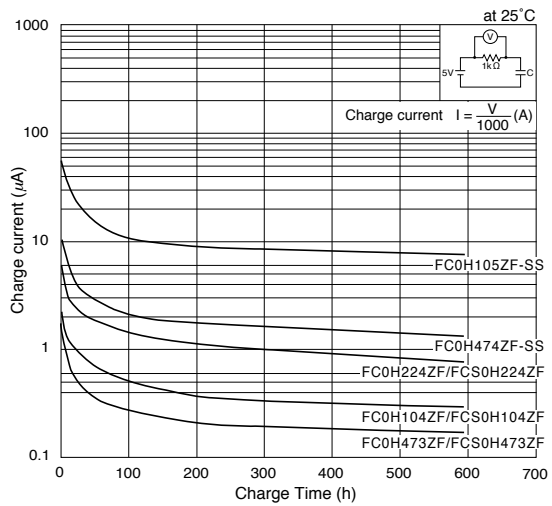

**Fig. 27 Charge Characteristic over Many Hours: FC Series**



- All specifications in this catalog and production status of products are subject to change without notice. Prior to the purchase, please contact TOKIN for updated product data.
- Please request for a specification sheet for detailed product data prior to the purchase.
- Before using the product in this catalog, please read "Precautions" and other safety precautions listed in the printed version catalog.

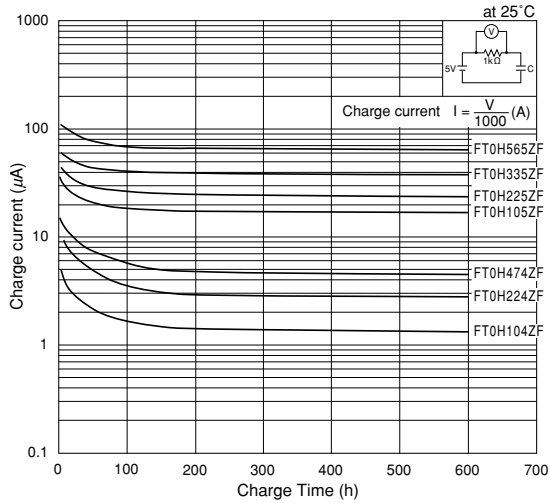

Fig. 28 Charge Characteristic over Many Hours: FT Series

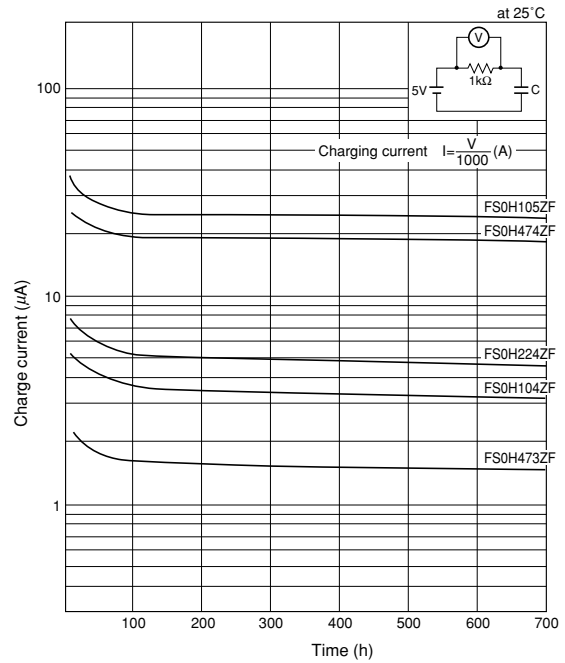

Fig. 29 Charge Characteristic over Many Hours: FS Series (0H)

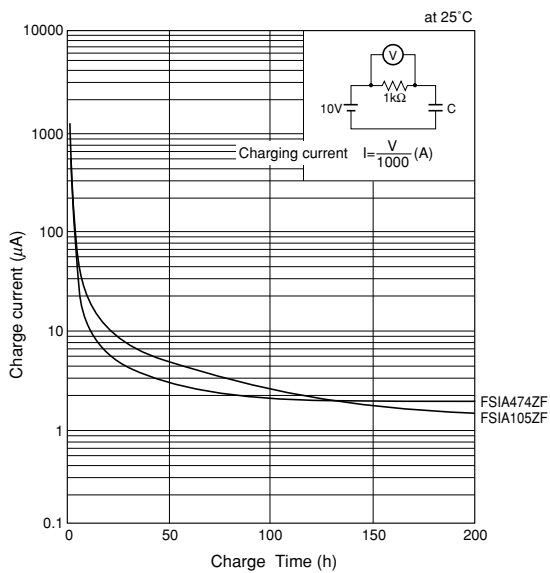

Fig. 30 Charge Characteristic over Many Hours: FS Series (1A)

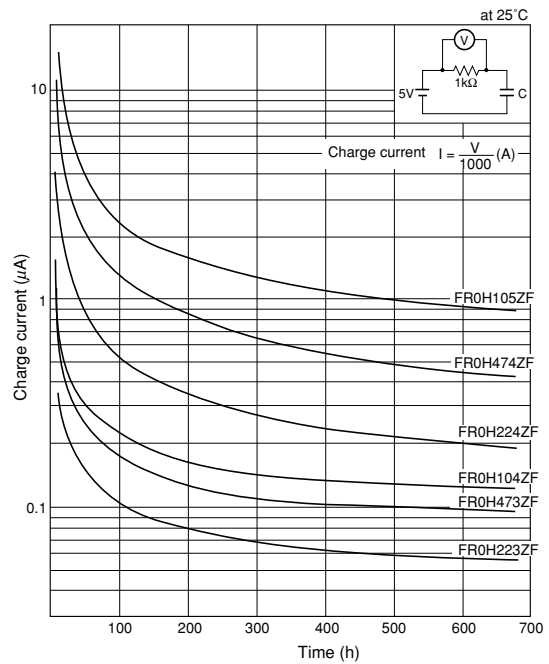
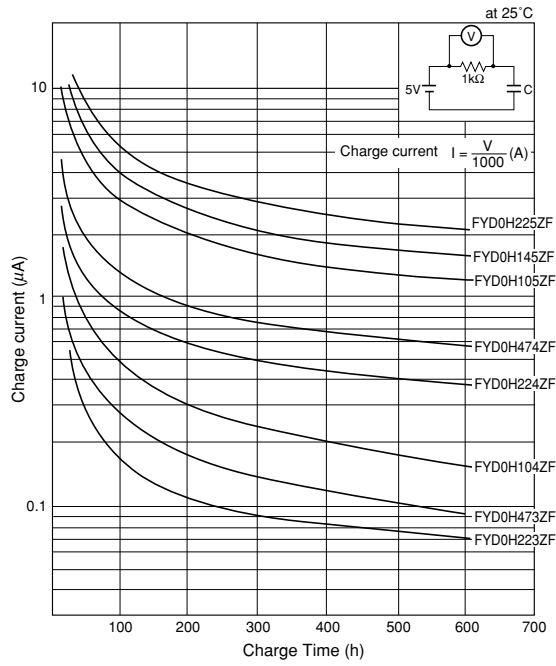

Fig. 31 Charge Characteristic over Many Hours: FR Series



- All specifications in this catalog and production status of products are subject to change without notice. Prior to the purchase, please contact TOKIN for updated product data.
- Please request for a specification sheet for detailed product data prior to the purchase.
- Before using the product in this catalog, please read "Precautions" and other safety precautions listed in the printed version catalog.



**Fig. 32 Charge Characteristic over Many Hours: FY Series (FYD Type)**

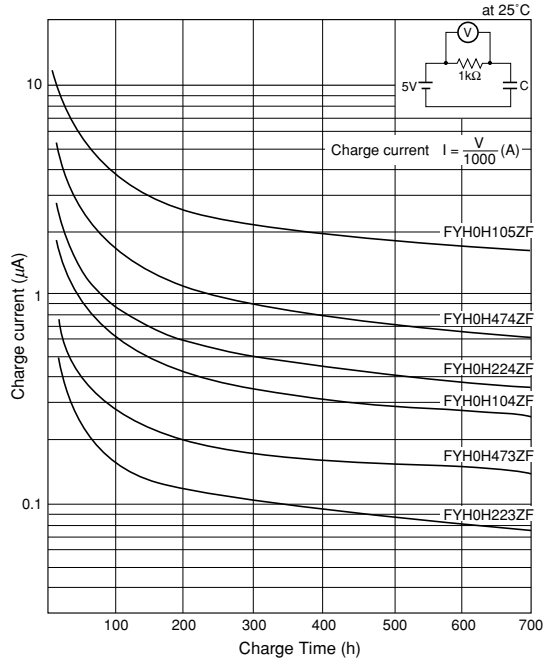

**Fig. 33 Charge Characteristic over Many Hours: FY Series (FYH Type)**

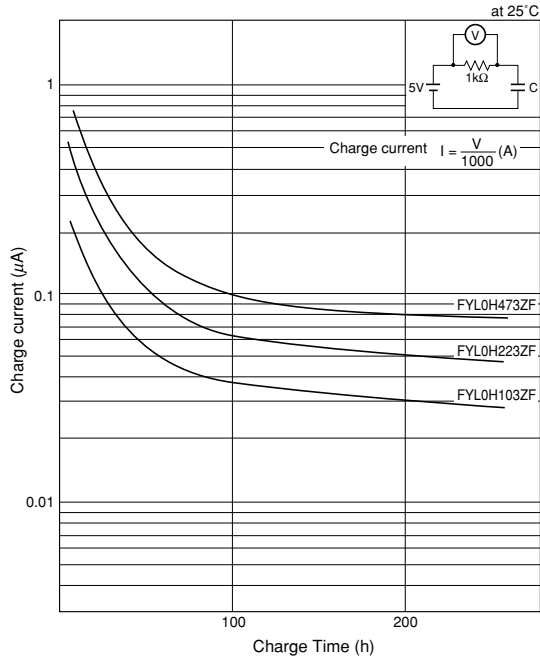

**Fig. 34 Charge Characteristic over Many Hours: FY Series (FYL Type)**

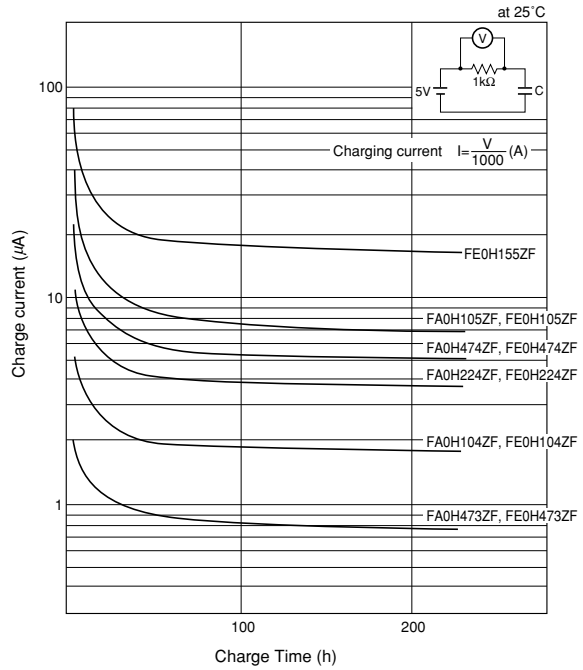

**Fig. 35 Charge Characteristic over Many Hours: FA Series (0H), FE Series**



- All specifications in this catalog and production status of products are subject to change without notice. Prior to the purchase, please contact TOKIN for updated product data.
- Please request for a specification sheet for detailed product data prior to the purchase.
- Before using the product in this catalog, please read "Precautions" and other safety precautions listed in the printed version catalog.



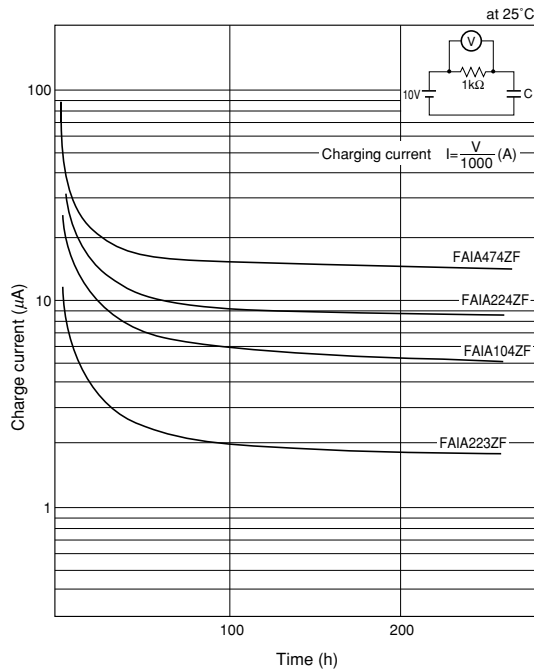

Fig. 36 Charge Characteristic over Many Hours: FA Series (1A)

### 8.3 Estimation of Life

The external factor that must affect the life of a SuperCapacitor is the operating ambient temperature (average temperature).

If the life of a SuperCapacitor is defined as the point at which capacitance is reduced to 70% of the initial value, then it is known through high temperature load life tests that the life is reduced by half with an increase of 10°C temperature.

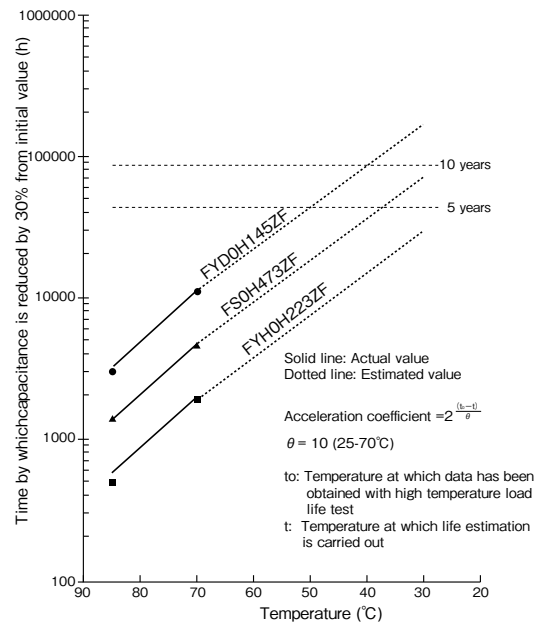
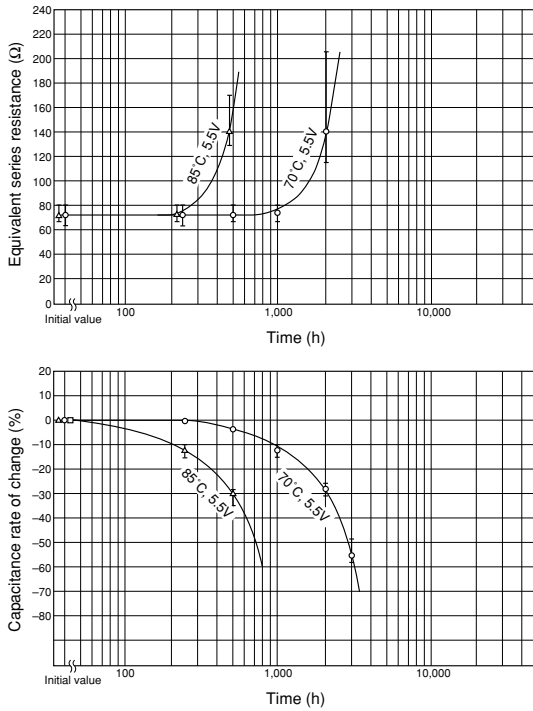

Fig. 37 Life Estimation



- All specifications in this catalog and production status of products are subject to change without notice. Prior to the purchase, please contact TOKIN for updated product data.
- Please request for a specification sheet for detailed product data prior to the purchase.
- Before using the product in this catalog, please read "Precautions" and other safety precautions listed in the printed version catalog.



**Fig. 38 High Temperature Load Life Test: FYH0H223ZF**

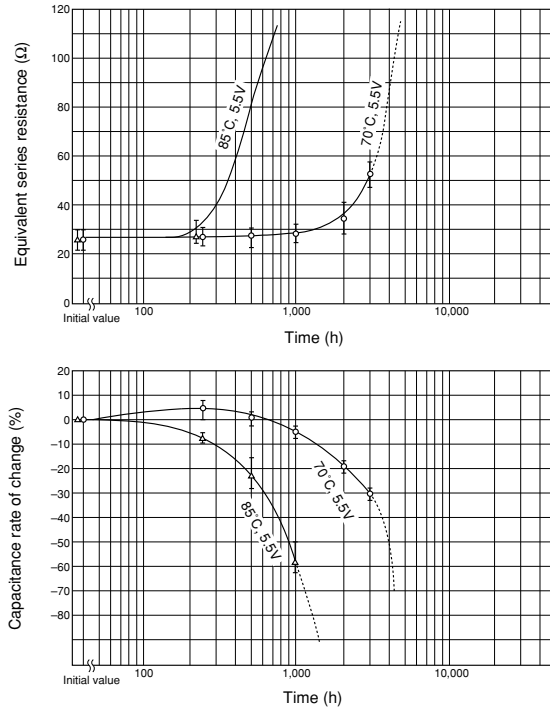

**Fig. 39 High Temperature Load Life Test: FM0H473ZF**

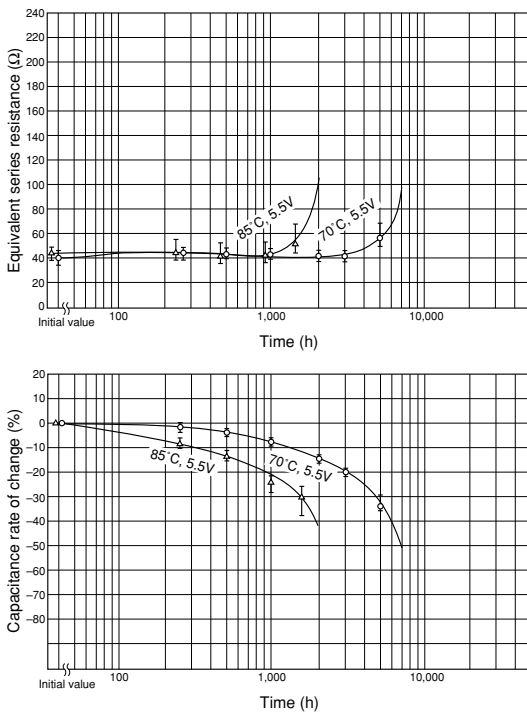

**Fig. 40 FS0H473ZF**

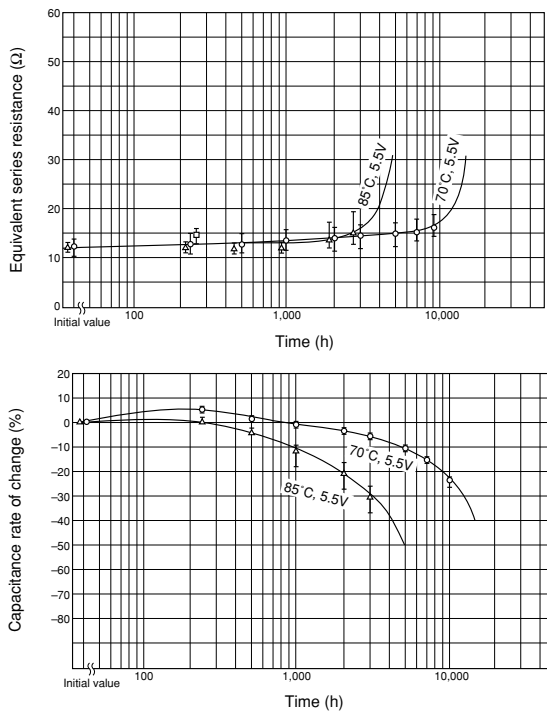

**Fig. 41 FYD0H145ZF**



- All specifications in this catalog and production status of products are subject to change without notice. Prior to the purchase, please contact TOKIN for updated product data.
- Please request for a specification sheet for detailed product data prior to the purchase.
- Before using the product in this catalog, please read "Precautions" and other safety precautions listed in the printed version catalog.

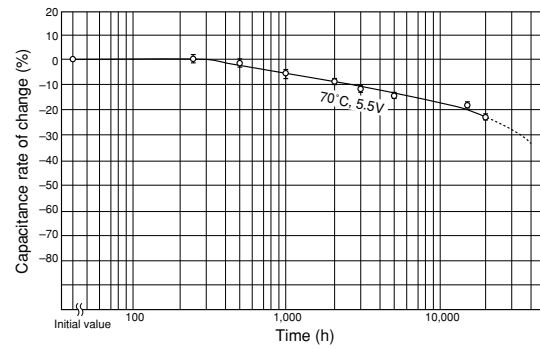
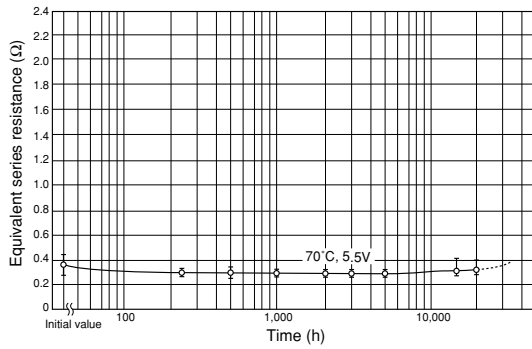

**Fig. 42 FE0H105ZF**

**(2) Overvoltage life**

The next external factor most affecting the life of a SuperCapacitor following the ambient temperature is the voltage applied. Applying overvoltage affects the life. However, if the voltage applied is equal to or lower than the maximum operating voltage, there is almost no influence. The results of overvoltage life tests for the FS0H473ZF (Figure 43) and FY series (Figure 44) are shown below.

**Failure rate**

The failure rate of a SuperCapacitor is estimated to be 0.06 Fit. The failure rate calculated based on market claim data is approximately 0.006 Fit. However, 0.06 Fit is assumed because it is estimated that there are ten times as many latent are not directly connected to returning of products.

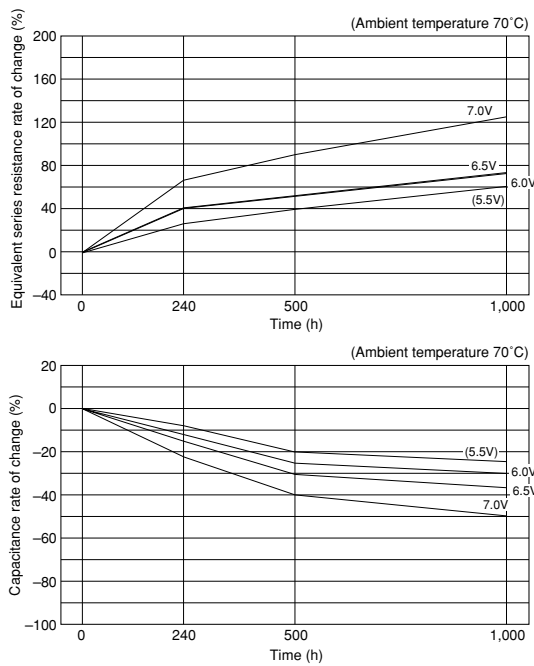

Note There are 10 samples for each voltage. The above figure shows their average.

**Fig. 43 FS0H473ZF Overvoltage Life Test**

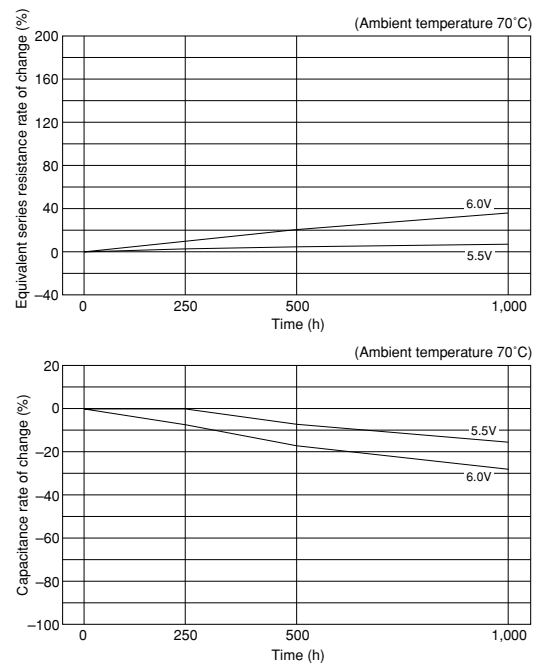

Note There are 20 samples for each voltage. The above figure shows their average.

**Fig. 44 FYH0H223ZF Overvoltage Life Test**



- All specifications in this catalog and production status of products are subject to change without notice. Prior to the purchase, please contact TOKIN for updated product data.
- Please request for a specification sheet for detailed product data prior to the purchase.
- Before using the product in this catalog, please read "Precautions" and other safety precautions listed in the printed version catalog.

**8.4 Washing Resistance**

Standard SuperCapacitor products except the FM series are not designed to be washed. However, a washing-resistant product is available which has been resin-sealed to prevent washing liquid from permeating into the product.

Figure 45 shows a cross section of a washing-resistant product. Table 2 shows a list of washing-resistant products and Table 3 shows their washing-resistant performance.

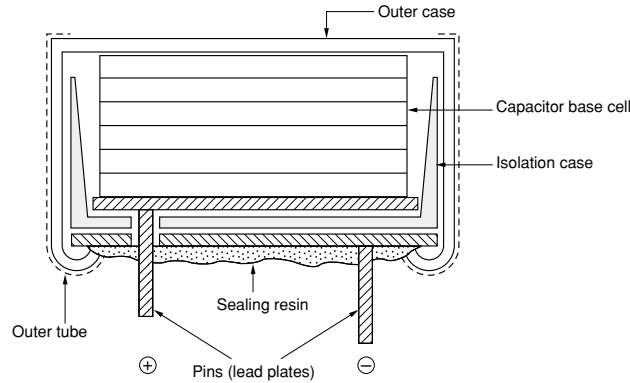

**Fig. 45 Cross Section of SuperCapacitor(Washing-Resistant Product)**

**Table 2. Washing-Resistant Products**

Series Name	Name of Washing-Resistant Product	Name of Non-Washing-Resistant Product	Remarks
FA	FAW . . . . .	FA . . . . .	W : Denotes washing-resistant product.
FE	FEW . . . . .	FE . . . . .	
FS	FSW . . . . .	FS . . . . .	
FSH	FSH . . . . . - W	FSH . . . . .	
FYD	FYD . . . . . - W	FYD . . . . .	
FYH	FYH . . . . . - W	FYH . . . . .	
FR	FRW . . . . .	FR . . . . .	
FG	FGW . . . . .	FG . . . . .	
FGH	FGH . . . . . - W	FGH . . . . .	
FT	FTW . . . . .	FT . . . . .	
FM	FM . . . . .	None	

\* FC Series are not washable.

**Table 3. Washing Resistance of Washing-Resistant (Resin-Sealed) Product**

Series Name	Product Name	Washing Solution	Washing Method	Washing Times	Remarks
FA	FAW . . . . .	Alcohol Water	Dipping at normal temperature	Within 10 minutes	When combining different washing methods, the total washing time should not be exceed 10 minutes.
			Boiling, vapor	Within 2 minutes	
			Warm water (70 °C or below)	Within 2 minutes	
			Ultrasonic	Within 1 minute	
FE	FEW . . . . .	Ditto	Ditto	Ditto	Ditto
FS	FSW . . . . .	Ditto	Ditto	Ditto	Ditto
FSH	FSH . . . . . - W	Ditto	Ditto	Ditto	Ditto
FYD	FYD . . . . . - W	Ditto	Ditto	Ditto	Ditto
FYH	FYH . . . . . - W	Ditto	Ditto	Ditto	Ditto
FR	FRW . . . . .	Ditto	Ditto	Ditto	Ditto
FG	FGW . . . . .	Ditto	Ditto	Ditto	Ditto
FGH	FGH . . . . . - W	Ditto	Ditto	Ditto	Ditto
FT	FTW . . . . .	Ditto	Ditto	Ditto	Ditto
FM	FM . . . . .	Ditto	Ditto	Ditto	Ditto



- All specifications in this catalog and production status of products are subject to change without notice. Prior to the purchase, please contact TOKIN for updated product data.
- Please request for a specification sheet for detailed product data prior to the purchase.
- Before using the product in this catalog, please read "Precautions" and other safety precautions listed in the printed version catalog.

**8.5 Influence of Inverse Connection**

(1) There is no influence on the long-term reliability of a SuperCapacitor.

(2) In the manufacturing process, the SuperCapacitor is processed with a voltage applied in the positive direction. For this reason, there may be cases where a small amount of charge still remains. There is also a SuperCapacitor specific phenomenon in which a voltage which was previously applied returns. Special care is required to avoid damage to semiconductors, etc. which are vulnerable to an inverse voltage.

(3) Figure 46 shows the voltage retention characteristic for normal and inverse connections. It is seen from Figure 46 that the voltage retention characteristic deteriorates. However, even in the case of inverse connection, if the time of inverse charging exceeds 100 hours, it shows the same self-discharge characteristic as charging in the positive direction.

**8.6 Series and Parallel Connections**

**(1) Series connection**

Ensure that a voltage is distributed equally to all capacitors which are connected in series and that the voltage does not exceed the maximum operating voltage.

**(2) Parallel connection**

Any parallel connections are possible.

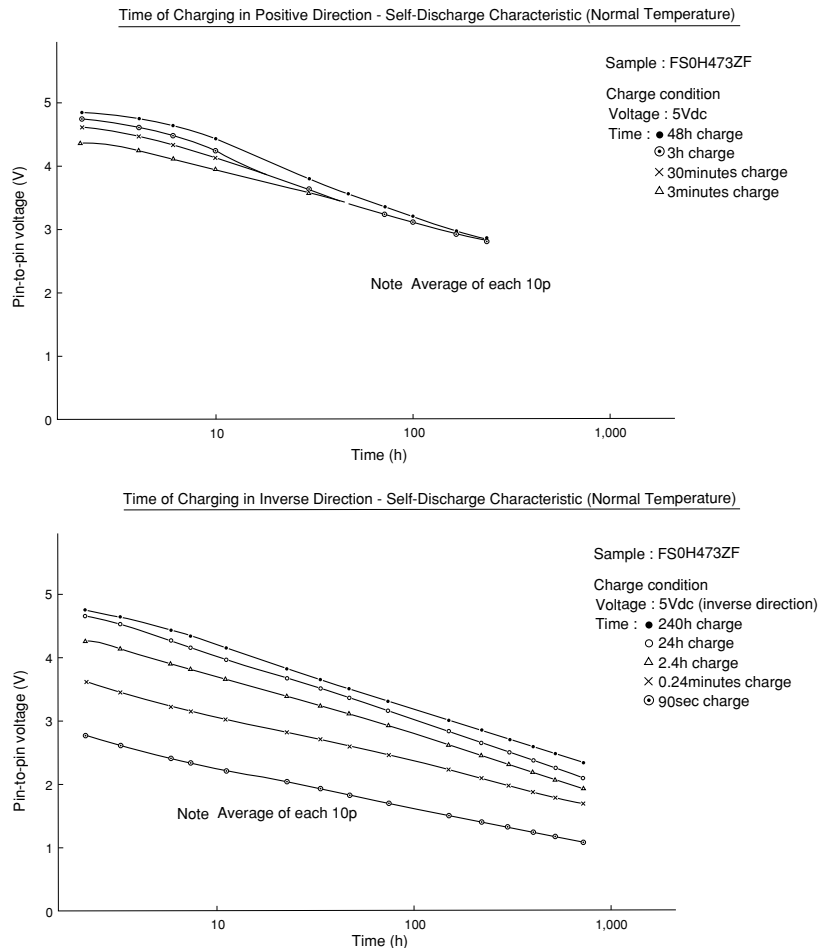

**Fig. 46 Voltage Retention Characteristic for Normal and Inverse Connections**



● All specifications in this catalog and production status of products are subject to change without notice. Prior to the purchase, please contact TOKIN for updated product data.  
 ● Please request for a specification sheet for detailed product data prior to the purchase.  
 ● Before using the product in this catalog, please read "Precautions" and other safety precautions listed in the printed version catalog.



## OPERATING PRECAUTIONS

### 1. Circuitry design

#### 1.1 Useful life

The electrical double layered capacitor (SuperCapacitor) uses electrolyte and is sealed with rubber etc. Water in the electrolyte can evaporate in use over long periods at high temperatures, thus reducing electrostatic capacity which in turn will create greater internal resistance. The characteristics of the SuperCapacitor can vary greatly depending on the environment it is used in. Therefore, controlling the usage environment will ensure prolonged life of the part.

Basic breakdown mode is an open mode due to increased internal resistance.

#### 1.2 Fail rate in the field

Based on field data, the fail rate is calculated at approx. 0.006Fit. We estimate that unreported failures are ten times this amount. Therefore, we assume that the fail rate is below 0.06Fit.

#### 1.3 Voltage application when maximum usable voltage is exceeded

Performance may be compromised, and in some cases leakage or damage may occur if applied voltage exceeds maximum working voltage.

#### 1.4 Use of capacitor as a smoothing capacitor (ripple absorption) in electrical circuits

As SuperCapacitors contain a high level of internal resistance, they are not recommended for use as electrical smoothing capacitors in electrical circuits.

Performance may be compromised, and in some cases leakage or damage may occur if a SuperCapacitor is used in ripple absorption.

#### 1.5 Series connections

As applied voltage balance to each SuperCapacitor is lost when used in series connection, excess voltage may be applied to some SuperCapacitors, which will not only negatively affect its performance but may also cause leakage and/or damage.

Allow ample margin for maximum voltage or attach a circuit for applying equal voltage to each SuperCapacitor (partial pressure resistor/voltage divider) when using SuperCapacitors in series connection.

Also, arrange SuperCapacitors so that the temperature

between each capacitor will not vary.

#### 1.6 Outer sleeve insulation

The outer sleeve wrapped around the SuperCapacitor indicates that it is sealed, however the outer sleeve is not guaranteed for insulation purposes. Therefore, it cannot be used where insulation is necessary.

#### 1.7 Polar characteristics

The SuperCapacitor is manufactured so that the terminal on the outer case is negative (-). Align the (-) symbol during use. Even though discharging has been carried out prior to shipping, any residual electrical charge may negatively affect other parts.

#### 1.8 Use next to heat emitters

Useful life of the SuperCapacitor will be significantly affected if used near heat emitting items (coils, power transistors, and pistors etc) where the SuperCapacitor itself may become heated.

#### 1.9 Usage environment

This device cannot be used in any acidic, alkaline or similar type of environment.

### 2. Mounting

#### 2.1 Mounting onto a reflow furnace

Except for the FC series, it is not possible to mount this capacitor onto an IR / VPS reflow furnace. Do not immerse the capacitor into a soldering dip tank.

#### 2.2 Flow soldering conditions

Keep solder under 260°C and soldering time to within 10 seconds when using the flow automatic soldering method. (Except for the FC series)

#### 2.3 Installation using a soldering iron

Care must be taken to prevent the soldering iron from touching other parts when soldering. Keep the tip of the soldering iron under 400°C and soldering time to within 3 seconds. Always make sure that the temperature of the tip is controlled. Internal capacitor resistance is likely to increase if the terminals are overheated.



- All specifications in this catalog and production status of products are subject to change without notice. Prior to the purchase, please contact TOKIN for updated product data.
- Please request for a specification sheet for detailed product data prior to the purchase.
- Before using the product in this catalog, please read "Precautions" and other safety precautions listed in the printed version catalog.

#### **2.4 Lead terminal processing**

Do not attempt to bend or polish the capacitor terminals with sand paper etc. Soldering may not be possible if the metallic plating is removed from the top of the terminals.

#### **2.5 Cleaning, Coating, and Potting**

Except for the FM series, cleaning, coating, and potting must not be carried out. Consult us if this type of procedure is necessary.

Terminals should be dried at less than the maximum operating temperature after cleaning.

### **3. Storage**

#### **3.1 Temperature and Humidity**

Make sure that the SuperCapacitor is stored according to the following conditions: Temp.: 5~35°C (Standard 25), Humidity: 20~70% (Standard: 50%). Do not allow the build up of condensation through sudden temperature change.

#### **3.2 Environment conditions**

Make sure that there are no corrosive gasses like sulfur dioxide as penetration of the lead terminals is possible.

Always store this item in an area with low dust and dirt levels.

Make sure that the packaging will not be deformed through heavy loading, movement and/or knocks.

Keep out of direct sunlight, and away from radiation, static electricity, and magnetic fields.

#### **3.3 Maximum storage period**

This item may be stored up to one year from the date of delivery if stored at the conditions stated above.

This product should be safe to use even after being stored for over a 1 year period. However, depending on the storage conditions, we recommend that the soldering is checked.

### **4. Dismantling**

There is a small amount of electrolyte stored within the capacitor. Do not attempt to dismantle as direct skin contact with the electrolyte will cause burning.

This product should be treated as industrial waste and not is not to be disposed of by fire.

### **5. Applicable Laws and Regulations**

This product satisfies the requirements of the RoHS Directive (2002/95/EC) (related to the specified hazardous substances contained in electrical and electronic equipment).



- All specifications in this catalog and production status of products are subject to change without notice. Prior to the purchase, please contact TOKIN for updated product data.
- Please request for a specification sheet for detailed product data prior to the purchase.
- Before using the product in this catalog, please read "Precautions" and other safety precautions listed in the printed version catalog.

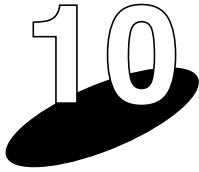

**FC-SERIES SuperCapacitor**  
(Surface Mounting Type)

FC Series SuperCapacitors are surface mounting type products. Generally, conventional electrically-double-layered capacitors have been mounted on surface mount PWBs by soldering with solder iron, or by being mounted on the holders soldered by the reflow soldering process in advance. FC Series SuperCapacitors have been developed for mounting directly by reflow soldering.

**Features**

- Surface mounting possible
- Wide range of temperature from -25°C to +70°C
- Maintenance free
- High rated voltage of 5.5V guaranteed
- High reliability for prevention of liquid leakage Maintenance free.
- Lead-free type. RoHS Compliant.

**Application**

- Sub-power supply
- Backup of power supply
- Backup of memory at battery exchange

**Part Number System**

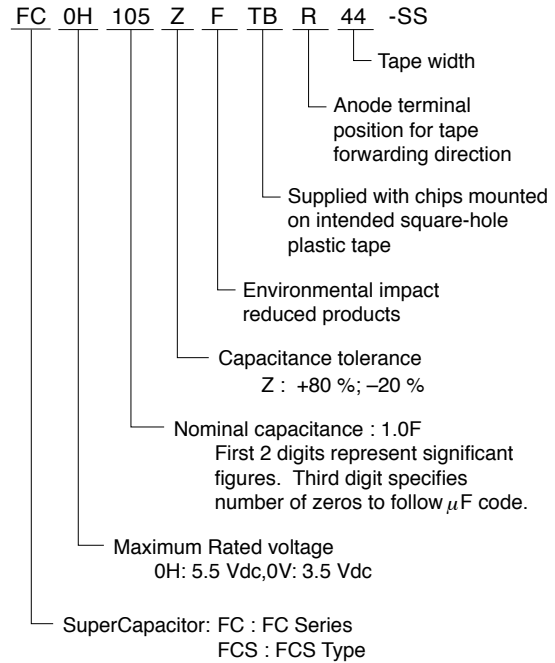

- All specifications in this catalog and production status of products are subject to change without notice. Prior to the purchase, please contact TOKIN for updated product data.
- Please request for a specification sheet for detailed product data prior to the purchase.
- Before using the product in this catalog, please read "Precautions" and other safety precautions listed in the printed version catalog.



**Precautions for use**

- This series is exclusively for reflow soldering. It is designed for thermal conduction system such as combination use of infrared ray and heat blow. Consult with TOKIN before applying other methods.
- The reflow condition must be kept within reflow profile graphs shown below.

- Applying reflow soldering is limited to 2 times. After the first reflow, cool down the capacitor thoroughly to 5-35°C before the second reflow.

Always consult with TOKIN when applying reflow soldering in a more severe condition than the condition described here.

• FCS Type

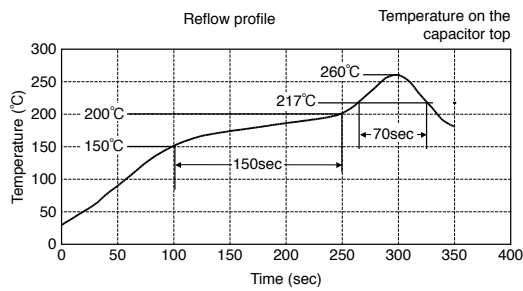

- Above "Reflow Profile" graph indicates temperature at the terminals and capacitor top.

Peak temperature	Below 260°C
Over 255°C	Within 10sec.
Over 230°C	Within 45sec.
Over 220°C	Within 60sec.
Over 217°C	Within 70sec.
Time between 150°C to 200°C (temperature zone over 170°C = within 50sec.)	150sec.

• FC Type

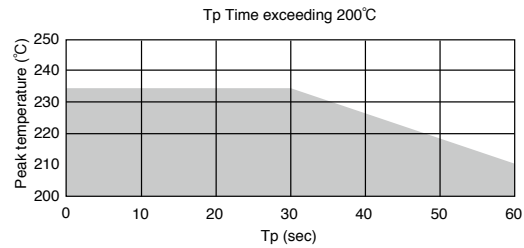
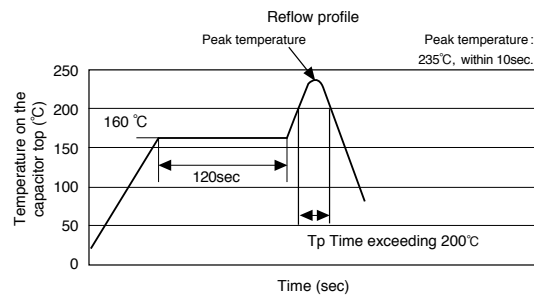

- Above "Reflow Profile" graph indicates temperature at the terminals and capacitor top.



- All specifications in this catalog and production status of products are subject to change without notice. Prior to the purchase, please contact TOKIN for updated product data.
- Please request for a specification sheet for detailed product data prior to the purchase.
- Before using the product in this catalog, please read "Precautions" and other safety precautions listed in the printed version catalog.

**Markings**

Nominal capacitance, maximum operating voltage, serial number, and polarity are marked.

**Conversion table for manufacture date code**

Year	2010	'11	'12	'13	'14	'15	'16	'17	'18	'19	'20	'21
Indication	A	B	C	D	E	F	H	J	K	L	M	N
Month	1	2	3	4	5	6	7	8	9	10	11	12
Indication	1	2	3	4	5	6	7	8	9	O	N	D

**Dimensions**

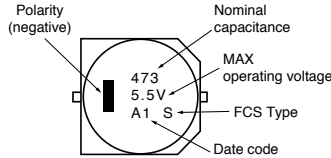
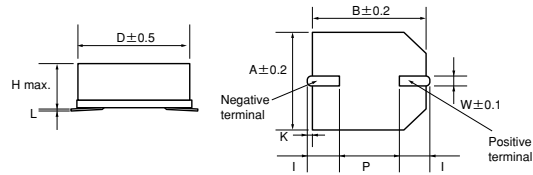

- FCS0H473ZFTBR24
- FCS0H104ZFTBR24
- FCS0H224ZFTBR24
- FCS0V104ZFTBR24
- FCS0V224ZFTBR24
- FCS0V474ZFTBR24

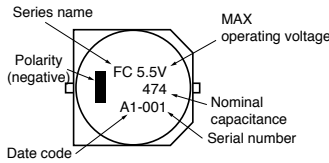

- FC0H474ZFTBR32-SS
- FC0H105ZFTBR44-SS

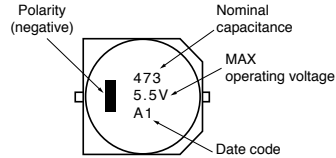

- FC0H473ZFTBR24
- FC0H104ZFTBR24
- FC0H224ZFTBR24
- FC0V104ZFTBR24
- FC0V224ZFTBR24
- FC0V474ZFTBR24

**Standard Ratings**

**FCS Type**

Part Number	Max. Operating Voltage (Vdc)	Nominal Capacitance Discharge system (F)	Max. ESR (at 1kHz) (Ω)	Max. current at 30 minutes (mA)	Voltage Holding Characteristic Min. (V)	Dimension (Unit:mm)										Weight (g)
						D	H	A	B	I	W	P	K	L		
FCS0H473ZFTBR24	5.5	0.047	100	0.071	4.2	10.7	5.5	10.8	10.8	3.9±0.5	1.2	5.0	0.9±0.3	0 <sup>+0.3</sup> <sub>-0.1</sub>	1.0	
FCS0H104ZFTBR24	5.5	0.10	50	0.15	4.2	10.7	5.5	10.8	10.8	3.9±0.5	1.2	5.0	0.9±0.3	0 <sup>+0.3</sup> <sub>-0.1</sub>	1.0	
FCS0H224ZFTBR24	5.5	0.22	50	0.33	4.2	10.7	8.5	10.8	10.8	3.9±0.5	1.2	5.0	0.9±0.3	0 <sup>+0.3</sup> <sub>-0.1</sub>	1.4	
FCS0V104ZFTBR24	3.5	0.10	100	0.09	—	10.7	5.5	10.8	10.8	3.9±0.5	1.2	5.0	0.9±0.3	0 <sup>+0.3</sup> <sub>-0.1</sub>	1.0	
FCS0V224ZFTBR24	3.5	0.22	50	0.20	—	10.7	5.5	10.8	10.8	3.9±0.5	1.2	5.0	0.9±0.3	0 <sup>+0.3</sup> <sub>-0.1</sub>	1.0	
FCS0V474ZFTBR24	3.5	0.47	50	0.42	—	10.7	8.5	10.8	10.8	3.9±0.5	1.2	5.0	0.9±0.3	0 <sup>+0.3</sup> <sub>-0.1</sub>	1.4	

**FC Type**

Part Number	Max. Operating Voltage (Vdc)	Nominal Capacitance Discharge system (F)	Max. ESR (at 1kHz) (Ω)	Max. current at 30 minutes (mA)	Voltage Holding Characteristic Min. (V)	Dimension (Unit:mm)										Weight (g)
						D	H	A	B	I	W	P	K	L		
FC0H473ZFTBR24	5.5	0.047	50	0.071	4.2	10.5	5.5	10.8	10.8	3.6±0.5	1.2	5.0	0.7±0.3	0 <sup>+0.3</sup> <sub>-0.1</sub>	1.0	
FC0H104ZFTBR24	5.5	0.10	25	0.15	4.2	10.5	5.5	10.8	10.8	3.6±0.5	1.2	5.0	0.7±0.3	0 <sup>+0.3</sup> <sub>-0.1</sub>	1.0	
FC0H224ZFTBR24	5.5	0.22	25	0.33	4.2	10.5	8.5	10.8	10.8	3.6±0.5	1.2	5.0	0.7±0.3	0 <sup>+0.3</sup> <sub>-0.1</sub>	1.4	
FC0H474ZFTBR32-SS	5.5	0.47	13	0.71	4.2	16.0	9.5	16.3	16.3	6.8±1.0	1.2	5.0	1.2±0.5	0 <sup>+0.5</sup> <sub>-0.1</sub>	4.0	
FC0H105ZFTBR44-SS	5.5	1.0	7	1.50	4.2	21.0	10.5	21.6	21.6	7.0±1.0	1.4	10.0	1.2±0.5	0 <sup>+0.5</sup> <sub>-0.1</sub>	6.7	
FC0V104ZFTBR24	3.5	0.10	50	0.09	—	10.5	5.5	10.8	10.8	3.6±0.5	1.2	5.0	0.7±0.3	0 <sup>+0.3</sup> <sub>-0.1</sub>	1.0	
FC0V224ZFTBR24	3.5	0.22	25	0.20	—	10.5	5.5	10.8	10.8	3.6±0.5	1.2	5.0	0.7±0.3	0 <sup>+0.3</sup> <sub>-0.1</sub>	1.0	
FC0V474ZFTBR24	3.5	0.47	25	0.42	—	10.5	8.5	10.8	10.8	3.6±0.5	1.2	5.0	0.7±0.3	0 <sup>+0.3</sup> <sub>-0.1</sub>	1.4	



- All specifications in this catalog and production status of products are subject to change without notice. Prior to the purchase, please contact TOKIN for updated product data.
- Please request for a specification sheet for detailed product data prior to the purchase.
- Before using the product in this catalog, please read "Precautions" and other safety precautions listed in the printed version catalog.

**Performance Characteristics**

Item	Series name	FC, FCS		Test conditions (conforming to JIS C 5160-1)
		5.5V type, 3.5V type		
Category temperature range		-25°C to +70°C		
MAX operating voltage		5.5Vdc, 3.5Vdc		
Capacitance		Refer to standard ratings		Refer to "Measurement Conditions"
Capacitance allowance		+80% , -20%		Refer to "Measurement Conditions"
ESR		Refer to standard ratings		Measured at 1kHz, 10mA ; See also "Measurement Conditions"
Current (30-minutes value)		Refer to standard ratings		Refer to "Measurement Conditions"
* Surge	Capacitance	More than 90% of initial specified value		Surge voltage : 4.0V (3.5V type, 3.6V type) : 6.3V (5.5V type) Charge : 30 sec. Discharge : 9min 30sec. Number of cycles : 1000 Series resistance : 0.043F, 0.047F 300Ω : 0.068F 240Ω : 0.10F 150Ω : 0.22F 56Ω : 0.47F 30Ω : 1.0F 15Ω Discharge resistance : 0Ω Temperature : 70±2°C
	ESR	Less than 120% of initial specified value		
	Current (30 minutes value)	Less than 120% of initial specified value		
	Appearance	No obvious abnormality		
* Characteristics in different temperature	Capacitance	Phase 2	More than 50% of initial measured value	Conforms to 4.17 Phase1 : +25±2°C Phase2 : -25±2°C Phase4 : +25±2°C Phase5 : +70±2°C Phase6 : +25±2°C
	ESR		Less than 400% of initial measured value	
	Capacitance	Phase 3		
	ESR			
	Capacitance	Phase 5	Less than 200% of initial measured value	
	ESR		Satisfy initial specified value	
	Current (30 minutes value)		1.5CV (mA) or below	
	Capacitance	Phase 6	Within ±20% of initial measured value	
	ESR		Satisfy initial specified value	
	Current (30 minutes value)		Satisfy initial specified value	
* Vibration resistance	Capacitance	Satisfy initial specified value		Conforms to 4.13 Frequency : 10 to 55 Hz Testing time : 6 hours
	ESR			
	Current (30 minutes value)			
	Appearance			
* Solder heat resistance	Capacitance	Satisfy initial specified value		Cooled down to ambient temperature after reflow soldering, then the product must fulfill the condition stated left. (See page 10 for reflow condition)
	ESR			
	Current (30 minutes value)			
	Appearance			
* Temperature cycle	Capacitance	Satisfy initial specified value		Conforms to 4.12 Temperature condition : -25°C→ Room temperature → +70°C→ Room temperature Number of cycles : 5 Cycles
	ESR			
	Current (30 minutes value)			
	Appearance			
* High temp. and high humidity resistance	Capacitance	Within ±20% of initial measured value		Conforms to 4.14 Temperature : 40±2°C Relative humidity : 90 to 95% RH Testing time : 240±8 hours
	ESR	Less than 120% of initial specified value		
	Current (30 minutes value)	Less than 120% of initial specified value		
	Appearance	No obvious abnormality		
* High temperature load	Capacitance	Within ±30% of initial measured value		Conforms to 4.15 Voltage applied : MAX operating voltage Temperature : 70±2°C Series protection resistance : 0Ω Testing time : 1000 <sup>±8</sup> Hours
	ESR	Less than 200% of initial specified value		
	Current (30 minutes value)	Less than 200% of initial specified value		
	Appearance	No obvious abnormality		
* Self discharge characteristics (voltage holding characteristics)	5.5V type: Voltage between terminal leads higher than 4.2V 3.5V type: Not specified		Charging condition	Voltage applied : 5.0Vdc (Terminal at the case's side be negative) Series resistance : 0Ω Charging time : 24 hours
			Storage	Let stand for 24 hours in condition described below with terminals opened. Ambient temperature : Lower than 25°C Relative humidity : Lower than 70%RH

\* The characteristics above must be satisfied for asterisked items after the end of reflow soldering (according to the reflow condition shown on page 32).



- All specifications in this catalog and production status of products are subject to change without notice. Prior to the purchase, please contact TOKIN for updated product data.
- Please request for a specification sheet for detailed product data prior to the purchase.
- Before using the product in this catalog, please read "Precautions" and other safety precautions listed in the printed version catalog.

**Tape and Reel Dimensions**

**[Reel Dimensions]**

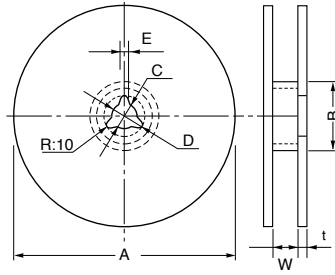

(mm)			
Mark	TBR24	TBR32	TBR44
A	380±2	330±2	380±2
B	Product height 5.5mm	80±1	100±1
	Product height 8.5mm	100±1	
C	13±0.5	13±0.5	13±0.5
D	21±0.8	21±0.8	21±0.8
E	2±0.5	2±0.5	2±0.5
W	Product height 5.5mm	25.5±0.5	33.5±1.0
	Product height 8.5mm	25.5±1.0	
t	2.0	2.0	2.0

**Dimensions of indented [square-hole plastic tape]**

**TBR16/24**

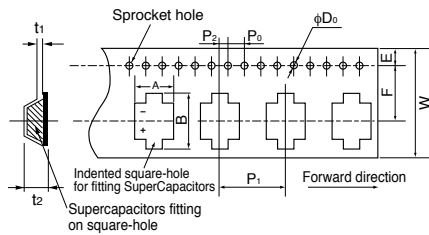

(mm)			
Mark	TBR24	TBR32	TBR44
W	24.0	32.0	44.0
A	11.4	18.0	23.0
B	13.0	20.0	25.0
P <sub>0</sub>	4.0	4.0	4.0
P <sub>1</sub>	16.0	24.0	32.0
P <sub>2</sub>	2.0	2.0	2.0
F	11.5	14.2	20.2
φ D <sub>0</sub>	1.55	1.55	1.55
t <sub>1</sub>	0.4	0.5	0.5
E	1.75	1.75	1.75
	Product height 5.5mm	6.0	10.0
Product height 8.5mm	8.4		
G	-	28.4	40.4

**TBR32/44**

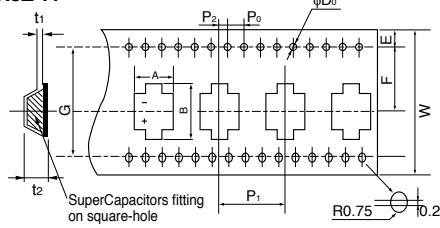

**Recommended land pattern**

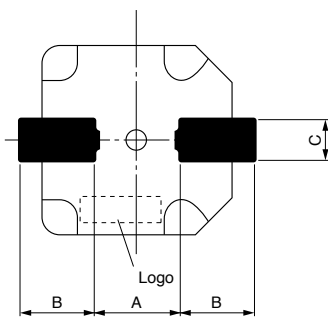

**Land pattern**

Part Number	(mm)		
	A	B	C
FCS0H473ZFTBR24	5.0	4.9	2.5
FCS0H104ZFTBR24	5.0	4.9	2.5
FCS0H224ZFTBR24	5.0	4.9	2.5
FCS0V104ZFTBR24	5.0	4.9	2.5
FCS0V224ZFTBR24	5.0	4.9	2.5
FCS0V474ZFTBR24	5.0	4.9	2.5
FC0H473ZFTBR24	5.0	4.9	2.5
FC0H104ZFTBR24	5.0	4.9	2.5
FC0H224ZFTBR24	5.0	4.9	2.5
FC0H474ZFTBR32-SS	5.0	10.0	2.5
FC0H105ZFTBR44-SS	10.0	10.5	3.5
FC0V104ZFTBR24	5.0	4.9	2.5
FC0V224ZFTBR24	5.0	4.9	2.5
FC0V474ZFTBR24	5.0	4.9	2.5

**Lead terminal**

Part Number	(mm)		
	A	B	C
FCS0H473ZFTBR24	5.0	3.9	1.2
FCS0H104ZFTBR24	5.0	3.9	1.2
FCS0H224ZFTBR24	5.0	3.9	1.2
FCS0V104ZFTBR24	5.0	3.9	1.2
FCS0V224ZFTBR24	5.0	3.9	1.2
FCS0V474ZFTBR24	5.0	3.9	1.2
FC0H473ZFTBR24	5.0	3.6	1.2
FC0H104ZFTBR24	5.0	3.6	1.2
FC0H224ZFTBR24	5.0	3.6	1.2
FC0H474ZFTBR32-SS	5.0	6.8	1.2
FC0H105ZFTBR44-SS	10.0	7.0	1.4
FC0V104ZFTBR24	5.0	3.6	1.2
FC0V224ZFTBR24	5.0	3.6	1.2
FC0V474ZFTBR24	5.0	3.6	1.2



- All specifications in this catalog and production status of products are subject to change without notice. Prior to the purchase, please contact TOKIN for updated product data.
- Please request for a specification sheet for detailed product data prior to the purchase.
- Before using the product in this catalog, please read "Precautions" and other safety precautions listed in the printed version catalog.

**Typical Performance Data**

**Resistance discharge characteristic (Backup time capability)**

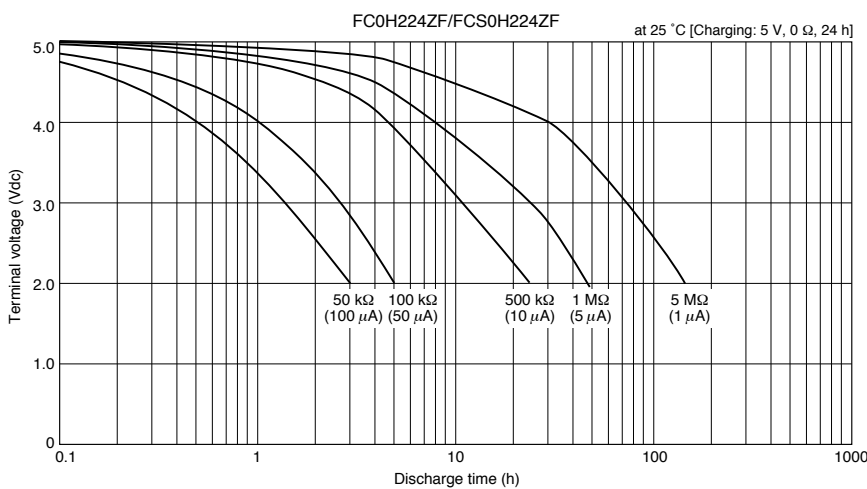
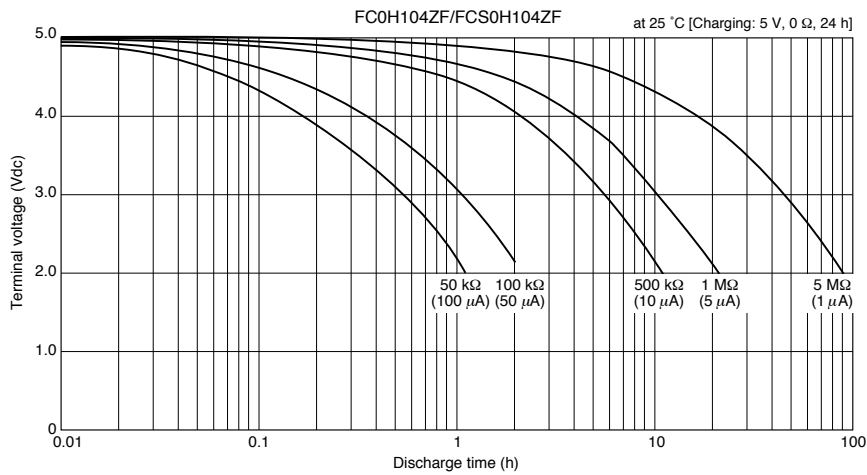
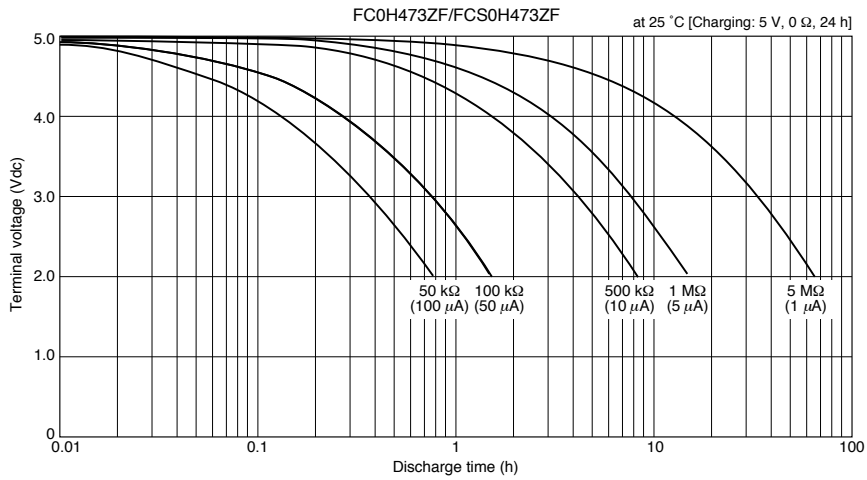

- All specifications in this catalog and production status of products are subject to change without notice. Prior to the purchase, please contact TOKIN for updated product data.
- Please request for a specification sheet for detailed product data prior to the purchase.
- Before using the product in this catalog, please read "Precautions" and other safety precautions listed in the printed version catalog.

**Resistance discharge characteristic (Backup time capability)**

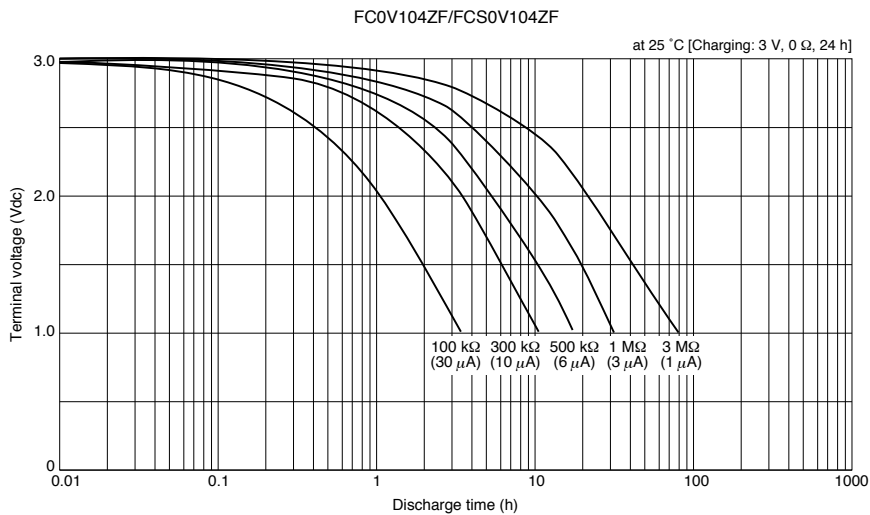
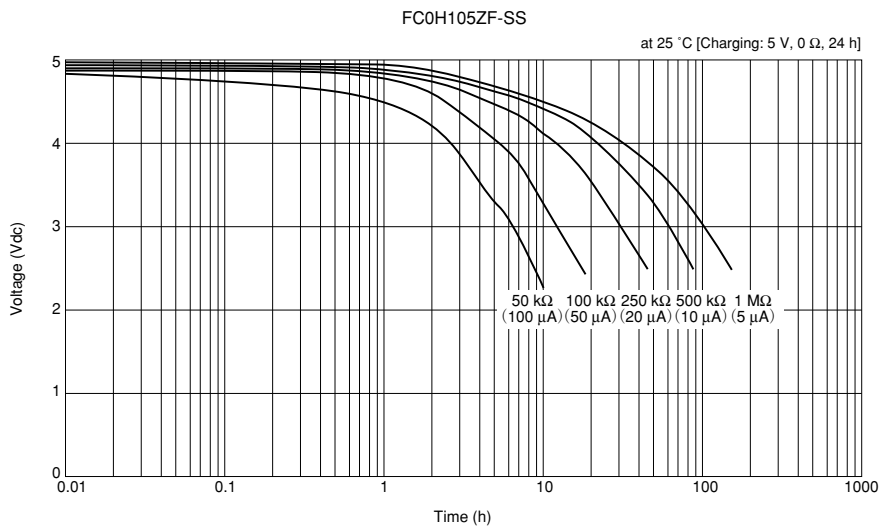
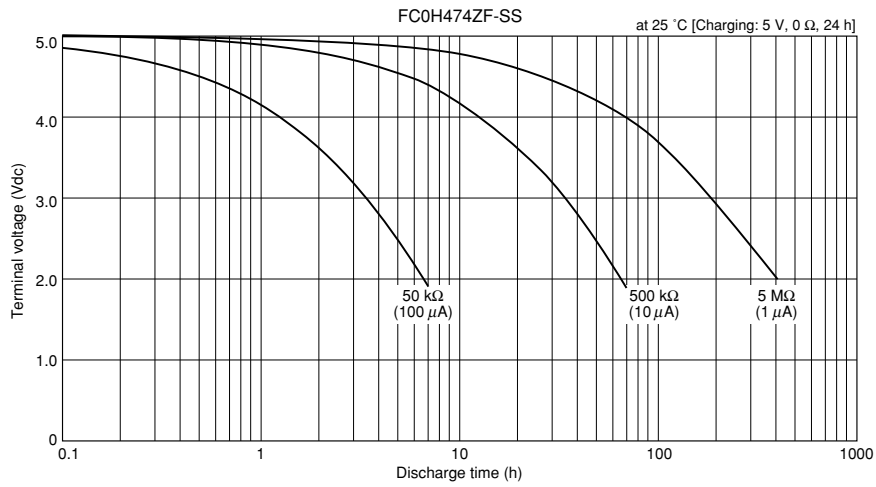

- All specifications in this catalog and production status of products are subject to change without notice. Prior to the purchase, please contact TOKIN for updated product data.
- Please request for a specification sheet for detailed product data prior to the purchase.
- Before using the product in this catalog, please read "Precautions" and other safety precautions listed in the printed version catalog.

**Resistance discharge characteristic (Backup time capability)**

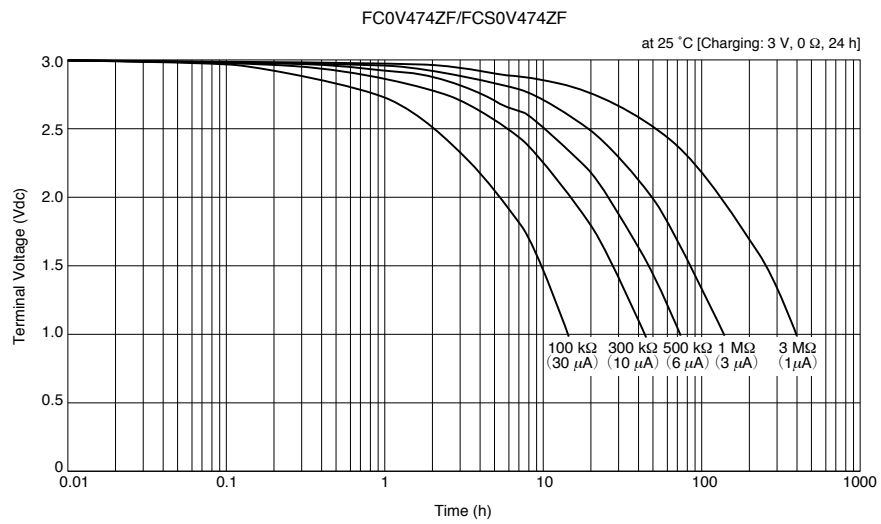
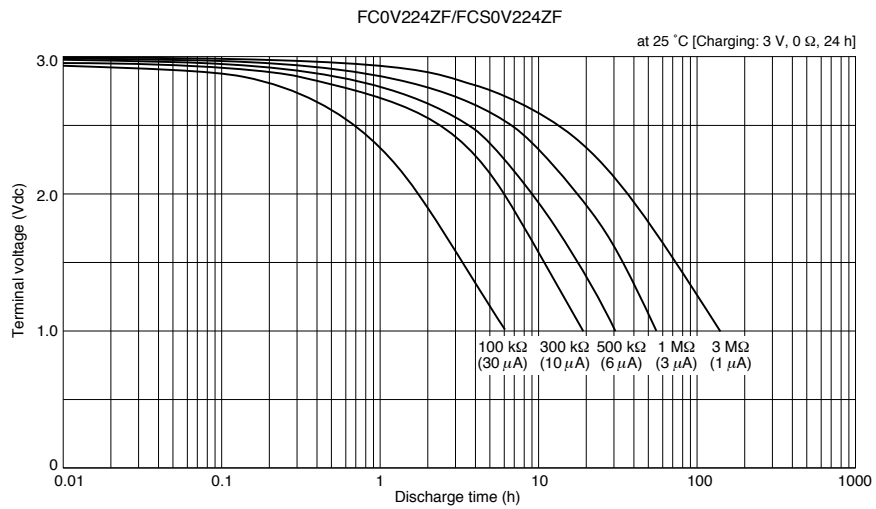

- All specifications in this catalog and production status of products are subject to change without notice. Prior to the purchase, please contact TOKIN for updated product data.
- Please request for a specification sheet for detailed product data prior to the purchase.
- Before using the product in this catalog, please read "Precautions" and other safety precautions listed in the printed version catalog.

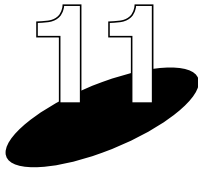

## FM-SERIES SuperCapacitor

(Resin Molded, Automatic Assembly)

The FM-Series SuperCapacitors have been developed for automatic assembly; thus, tape packaging is available in all product lines.

They are particularly suited for applications requiring a long backup time capability and small backup current such as microprocessor and memory backup. (FME type are backup devices adaptable to current consumption mA level.)

### Features

- High adaptability of automatic assembly
- Cleanable
- Excellent voltage holding characteristics. (Except 3.5 V, 6.5 V type FME type)
- Wide operating range: -25 to +70 °C (-40 to +85°C for FMR type)
- Easily chargeable (fast charge time)
- Maintenance-free
- Small installation area
- Lead-free type. RoHS Compliant.

### Application

Backup of CMOS Microprocessor, SRAM, DTS, ICs, etc.

(2) Folded tape packaging (Ammo Pack)

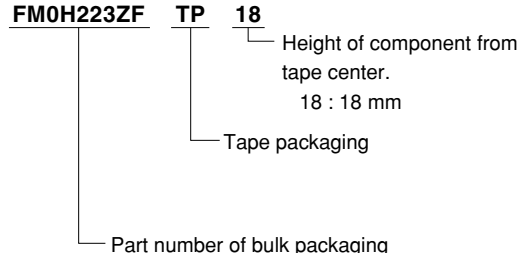

### Part Number System

(1) Bulk

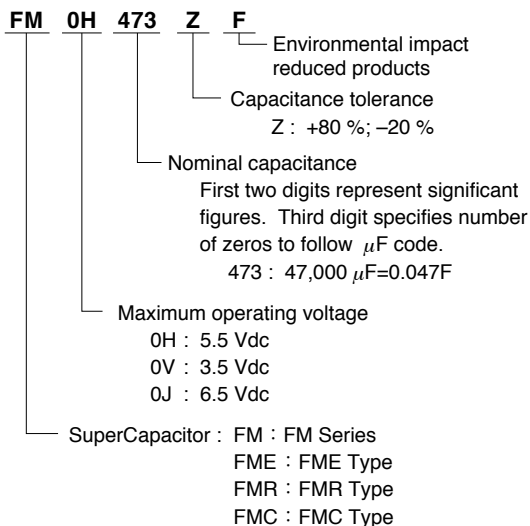

- All specifications in this catalog and production status of products are subject to change without notice. Prior to the purchase, please contact TOKIN for updated product data.
- Please request for a specification sheet for detailed product data prior to the purchase.
- Before using the product in this catalog, please read "Precautions" and other safety precautions listed in the printed version catalog.



**Dimensions**

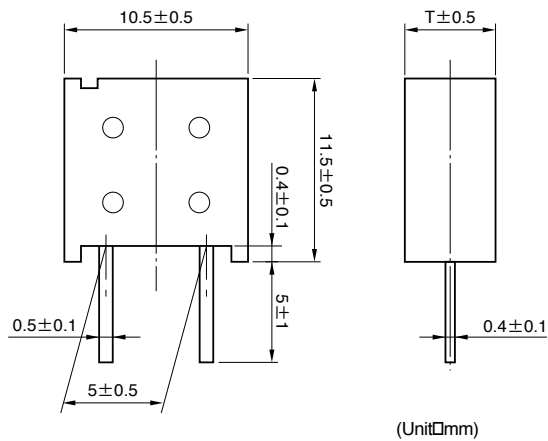

**Markings**

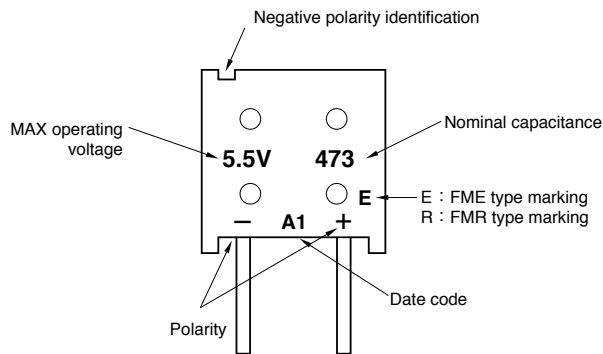

**Conversion table for manufacture date code**

Year	'10	'11	'12	'13	'14	'15	'16	'17	'18	'19	'20	'21
Indication	A	B	C	D	E	F	H	J	K	L	M	N
Month	1	2	3	4	5	6	7	8	9	10	11	12
Indication	1	2	3	4	5	6	7	8	9	O	N	D

**Lead Terminal Forming Example**

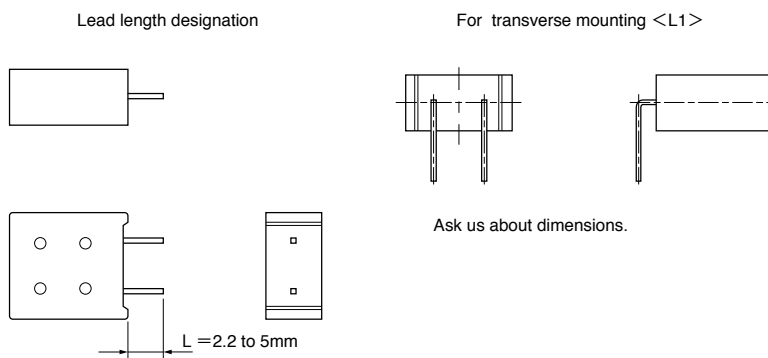

- All specifications in this catalog and production status of products are subject to change without notice. Prior to the purchase, please contact TOKIN for updated product data.
- Please request for a specification sheet for detailed product data prior to the purchase.
- Before using the product in this catalog, please read "Precautions" and other safety precautions listed in the printed version catalog.

**Standard Ratings**

5.5V Type									
Part Number		MAX operating voltage (Vdc)	Nominal capacitance		MAX ESR (at 1 kHz) (Ω)	MAX current at 30 min. (mA)	Voltage holding characteristics (V)	T (mm)	Weight (g)
Bulk	Ammo pack		Charge system(F)	Discharge system(F)					
FM0H103ZF	FM0H103ZFTP18	5.5	0.01	0.014	300	0.015	4.2	5.0	1.3
FM0H223ZF	FM0H223ZFTP18	5.5	0.022	0.028	200	0.033	4.2	5.0	1.3
FM0H473ZF	FM0H473ZFTP18□	5.5	0.047	0.06	200	0.071	4.2	5.0	1.3
FM0H104ZF	FM0H104ZFTP18	5.5	0.10	0.13	100	0.15	4.2	6.5	1.6
FM0H224ZF	FM0H224ZFTP18	5.5	—	0.22	100	0.33	4.2	6.5	1.6

3.5V Type									
Part Number		MAX operating voltage (Vdc)	Nominal capacitance		MAX ESR (at 1 kHz) (Ω)	MAX current at 30 min. (mA)	T (mm)	Weight (g)	
Bulk	Ammo pack		Charge system(F)	Discharge system(F)					
FM0V473ZF	FM0V473ZFTP18	3.5	0.047	0.06	200	0.042	5.0	1.3	
FM0V104ZF	FM0V104ZFTP18	3.5	0.10	0.13	100	0.090	5.0	1.3	
FM0V224ZF	FM0V224ZFTP18	3.5	0.22	0.30	100	0.20	6.5	1.6	

6.5V Type									
Part Number		MAX operating voltage (Vdc)	Nominal capacitance		MAX ESR (at 1 kHz) (Ω)	MAX current at 30 min. (mA)	T (mm)	Weight (g)	
Bulk	Ammo pack		Charge system(F)	Discharge system(F)					
FM0J473ZF	FM0J473ZFTP18	6.5	0.047	0.062	200	0.071	6.5	1.6	

FME Type (Backup Large Current, mA Order)									
Part Number		MAX operating voltage (Vdc)	Nominal capacitance		MAX ESR (at 1 kHz) (Ω)	MAX current at 30 min. (mA)	T (mm)	Weight (g)	
Bulk	Ammo pack		Charge system(F)	Discharge system(F)					
FME0H223ZF	FME0H223ZFTP18	5.5	0.022	0.028	40	0.033	5.0	1.3	
FME0H473ZF	FME0H473ZFTP18	5.5	0.047	0.06	20	0.071	5.0	1.3	

FMR Type (MAX Operating Temperature 85°C Type)									
Part Number		MAX operating voltage (Vdc)	Nominal capacitance		MAX ESR (at 1 kHz) (Ω)	MAX current at 30 min. (mA)	Voltage holding characteristics (V)	T (mm)	Weight (g)
Bulk	Ammo pack		Charge system(F)	Discharge system(F)					
FMR0H473ZF	FMR0H473ZFTP18	5.5	0.047	0.062	200	0.071	4.2	6.5	1.6
FMR0H104ZF	FMR0H104ZFTP18	5.5	0.10		50	0.15	4.2	6.5	1.6
FMR0V104ZF	FMR0V104ZFTP18	3.5	0.10		50	0.090	—	6.5	1.6



- All specifications in this catalog and production status of products are subject to change without notice. Prior to the purchase, please contact TOKIN for updated product data.
- Please request for a specification sheet for detailed product data prior to the purchase.
- Before using the product in this catalog, please read "Precautions" and other safety precautions listed in the printed version catalog.

**FMC Type**

**Chip parts applicable to treatment in bond hardening furnace (160±5°C for 120±10 seconds)**

**Dimensions**

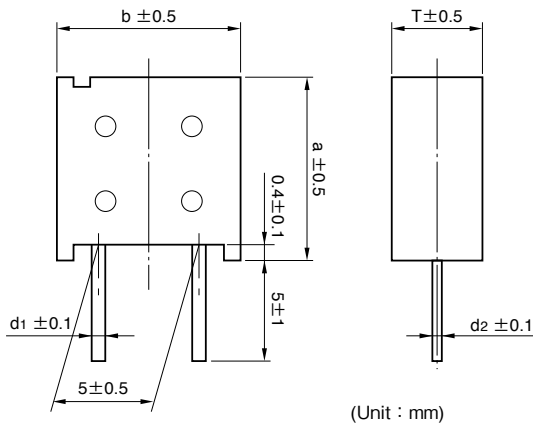

**Markings**

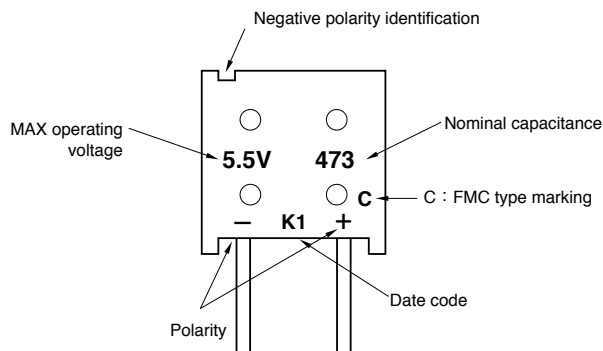

**Standard Ratings**

Part Number		MAX operating voltage (Vdc)	Nominal capacitance		MAX ESR (at 1 kHz) (Ω)	MAX current at 30 min. (mA)	Voltage holding characteristics (V)	a (mm)	b (mm)	T (mm)	d <sub>1</sub> (mm)	d <sub>2</sub> (mm)	Weight (g)
Bulk	Ammo pack		Charge system(F)	Discharge system(F)									
FMC0H473ZF	FMC0H473ZFTP18	5.5	0.047	0.06	100	0.071	4.2	11.5	10.5	5.0	0.5	0.4	1.3
FMC0H104ZF	FMC0H104ZFTP18	5.5	0.10	0.13	50	0.15	4.2	11.5	10.5	6.5	0.5	0.4	1.6
FMC0H334ZF	FMC0H334ZFTP18	5.5	-	0.33	25	0.50	4.2	15.0	14.0	9.0	0.6	0.6	3.5



- All specifications in this catalog and production status of products are subject to change without notice. Prior to the purchase, please contact TOKIN for updated product data.
- Please request for a specification sheet for detailed product data prior to the purchase.
- Before using the product in this catalog, please read "Precautions" and other safety precautions listed in the printed version catalog.

**Performance Characteristics**

Item	Series name	5.5V type, 3.5V type, 6.5V type FMC type	FME type	Test conditions (conforming to JIS C 5160-1)
Category temperature range		-25°C to +70°C	-25°C to +70°C	
MAX operating voltage		5.5Vdc, 3.5Vdc, 6.5Vdc	5.5Vdc	
Capacitance		5.5V : 0.010F to 0.33F 3.5V : 0.047F to 0.22F 6.5V : 0.047	0.022F, 0.033F, 0.047F	Refer to "Measurement Conditions"
Capacitance allowance		+80% , -20%	+80% , -20%	Refer to "Measurement Conditions"
ESR		Refer to standard ratings	Refer to standard ratings	Measured at 1kHz, 10mA ; See also "Measurement Conditions"
Current (30-minutes value)		Refer to standard ratings	Refer to standard ratings	Refer to "Measurement Conditions"
Surge	Capacitance	More than 90% of initial specified value	More than 90% of initial specified value	Surge voltage : 4.0V (3.5V type) : 6.3V (5.5V type) : 7.4V (6.5V type)  Charge : 30 sec. Discharge : 9min 30sec. Number of cycles : 1000 Series resistance : 0.010F 1500 Ω : 0.022F 560 Ω : 0.033F 510 Ω : 0.047F 300 Ω : 0.068F 240 Ω : 0.10F 150 Ω : 0.22F 56 Ω : 0.33F 51 Ω  Discharge resistance : 0Ω Temperature : 70±2°C
	ESR	Less than 120% of initial specified value	Less than 120% of initial specified value	
	Current (30 minutes value)	Less than 120% of initial specified value	Less than 120% of initial specified value	
	Appearance	No obvious abnormality	No obvious abnormality	
Characteristics in different temperature	Capacitance	Phase 2 More than 50% of initial measured value	Phase 2 More than 50% of initial measured value	Conforms to 4.17 Phase1 : +25±2°C Phase2 : -25±2°C Phase4 : +25±2°C Phase5 : +70±2°C Phase6 : +25±2°C
	ESR	Phase 2 Less than 400% of initial measured value	Phase 2 Less than 300% of initial measured value	
	Capacitance	Phase 3 /	Phase 3 /	
	ESR	Phase 3 /	Phase 3 /	
	Capacitance	Phase 5 Less than 200% of initial measured value	Phase 5 Less than 150% of initial measured value	
	ESR	Phase 5 Satisfy initial specified value	Phase 5 Satisfy initial specified value	
	Current (30 minutes value)	Phase 5 1.5CV (mA) or below	Phase 5 1.5CV (mA) or below	
	Capacitance	Phase 6 Within ±20% of initial measured value	Phase 6 Within ±20% of initial measured value	
ESR	Phase 6 Satisfy initial specified value	Phase 6 Satisfy initial specified value		
Current (30 minutes value)	Phase 6 Satisfy initial specified value	Phase 6 Satisfy initial specified value		
Lead strength (tensile)		No terminal damage	No terminal damage	Conforms to 4.9
Vibration resistance	Capacitance	Satisfy initial specified value	Satisfy initial specified value	Conforms to 4.13 Frequency : 10 to 55 Hz Testing time : 6 hours
	ESR			
	Current (30 minutes value)			
	Appearance			
Solderability		Over 3/4 of the terminal should be covered by the new solder	Over 3/4 of the terminal should be covered by the new solder	Conforms to 4.11 Solder temp : 245±5°C Dipping time : 5±0.5 sec. 1.6mm from the bottom should be dipped.
Solder heat resistance	Capacitance	Satisfy initial specified value	Satisfy initial specified value	Conforms to 4.10 Solder temp : 260±10°C Dipping time : 10±1 sec. 1.6mm from the bottom should be dipped.
	ESR			
	Current (30 minutes value)			
	Appearance			
Temperature cycle	Capacitance	Satisfy initial specified value	Satisfy initial specified value	Conforms to 4.12 Temperature condition : -25°C → Room temperature → +70°C → Room temperature Number of cycles : 5 Cycles
	ESR			
	Current (30 minutes value)			
	Appearance			
High temp. and high humidity resistance	Capacitance	Within ±20% of initial measured value	Within ±20% of initial measured value	Conforms to 4.14 Temperature : 40±2°C Relative humidity : 90 to 95% RH Testing time : 240±8 hours
	ESR	Less than 120% of initial specified value	Less than 120% of initial specified value	
	Current (30 minutes value)	Less than 120% of initial specified value	Less than 120% of initial specified value	
	Appearance	No obvious abnormality	No obvious abnormality	
High temperature load	Capacitance	Within ±30% of initial measured value	Within ±30% of initial measured value	Conforms to 4.15 Temperature : 70±2°C Voltage applied : MAX operating voltage Series protection resistance : 0Ω Testing time : 1000 <sup>+8</sup> Hours
	ESR	Less than 200% of initial specified value	Less than 200% of initial specified value	
	Current (30 minutes value)	Less than 200% of initial specified value	Less than 200% of initial specified value	
	Appearance	No obvious abnormality	No obvious abnormality	
Self discharge characteristics (voltage holding characteristics)		5.5V type: Voltage between terminal leads higher than 4.2V 3.5V type: Not specified 6.5V type: Not specified	/	Charging condition Voltage applied : 5.0Vdc (Terminal at the case's side be negative) Series resistance : 0Ω Charging time : 24 hours
				Storage Let stand for 24 hours in condition described below with terminals opened. Ambient temperature : Lower than 25°C Relative humidity : Lower than 70%RH



- All specifications in this catalog and production status of products are subject to change without notice. Prior to the purchase, please contact TOKIN for updated product data.
- Please request for a specification sheet for detailed product data prior to the purchase.
- Before using the product in this catalog, please read "Precautions" and other safety precautions listed in the printed version catalog.

**Performance Characteristics**

Item	Series name	FMR type		Test conditions (conforming to JIS C 5160-1)
Category temperature range		-40°C to +85°C		
MAX operating voltage		5.5Vdc, 3.5Vdc		
Capacitance		0.047F, 0.10F		Refer to "Measurement Conditions"
Capacitance allowance		+80% , -20%		Refer to "Measurement Conditions"
ESR		Refer to standard ratings		Measured at 1kHz, 10mA ; See also "Measurement Conditions"
Current (30-minutes value)		Refer to standard ratings		Refer to "Measurement Conditions"
Surge	Capacitance	More than 90% of initial specified value		Surge voltage : 4.0V (3.5V type) : 6.3V (5.5V type) Charge : 30 sec. Discharge : 9min 30sec. Number of cycles : 1000 Series resistance : 0.047F 300Ω : 0.10F 150Ω Discharge resistance : 0Ω Temperature : 85±2°C
	ESR	Less than 120% of initial specified value		
	Current (30 minutes value)	Less than 120% of initial specified value		
	Appearance	No obvious abnormality		
Characteristics in different temperature	Capacitance	Phase 2	More than 50% of initial measured value	Conforms to 4.17 Phase1 : +25±2°C Phase2 : -25±2°C Phase3 : -40±2°C Phase4 : +25±2°C Phase5 : +85±2°C Phase6 : +25±2°C
	ESR		Less than 400% of initial measured value	
	Capacitance	Phase 3	More than 30% of initial measured value	
	ESR		Less than 700% of initial measured value	
	Capacitance	Phase 5	Less than 200% of initial measured value	
	ESR		Satisfy initial specified value	
	Current (30 minutes value)		1.5CV (mA) or below	
	Capacitance	Phase 6	Within ±20% of initial measured value	
	ESR		Satisfy initial specified value	
	Current (30 minutes value)		Satisfy initial specified value	
Lead strength (tensile)		No terminal damage		Conforms to 4.9
Vibration resistance	Capacitance	Satisfy initial specified value		Conforms to 4.13 Frequency : 10 to 55 Hz Testing time : 6 hours
	ESR			
	Current (30 minutes value)			
	Appearance	No obvious abnormality		
Solderability		Over 3/4 of the terminal should be covered by the new solder		Conforms to 4.11 Solder temp : 245±5°C Dipping time : 5±0.5 sec. 1.6mm from the bottom should be dipped.
Solder heat resistance	Capacitance	Satisfy initial specified value		Conforms to 4.10 Solder temp : 260±10°C Dipping time : 10±1 sec. 1.6mm from the bottom should be dipped.
	ESR			
	Current (30 minutes value)			
	Appearance	No obvious abnormality		
Temperature cycle	Capacitance	Satisfy initial specified value		Conforms to 4.12 Temperature condition : -40°C→ Room temperature → +85°C→ Room temperature Number of cycles : 5 Cycles
	ESR			
	Current (30 minutes value)			
	Appearance	No obvious abnormality		
High temp. and high humidity resistance	Capacitance	Within ±20% of initial measured value		Conforms to 4.14 Temperature : 40±2°C Relative humidity : 90 to 95% RH Testing time : 240±8 hours
	ESR	Less than 120% of initial specified value		
	Current (30 minutes value)	Less than 120% of initial specified value		
	Appearance	No obvious abnormality		
High temperature load	Capacitance	Within ±30% of initial measured value		Conforms to 4.15 Temperature : 85±2°C Voltage applied : MAX operating voltage Series protection resistance : 0Ω Testing time : 1000 <sup>±8</sup> Hours
	ESR	Less than 200% of initial specified value		
	Current (30 minutes value)	Less than 200% of initial specified value		
	Appearance	No obvious abnormality		
Self discharge characteristics (voltage holding characteristics)		5.5V type: Voltage between terminal leads higher than 4.2V 3.5V type: Not specified		Charging condition : Voltage applied : 5.0Vdc (Terminal at the case's side be negative) Series resistance : 0Ω Charging time : 24 hours
				Storage : Let stand for 24 hours in condition described below with terminals opened. Ambient temperature : Lower than 25°C Relative humidity : Lower than 70%RH



- All specifications in this catalog and production status of products are subject to change without notice. Prior to the purchase, please contact TOKIN for updated product data.
- Please request for a specification sheet for detailed product data prior to the purchase.
- Before using the product in this catalog, please read "Precautions" and other safety precautions listed in the printed version catalog.

**Taping Specifications [except FMC0H334ZFTP18]**

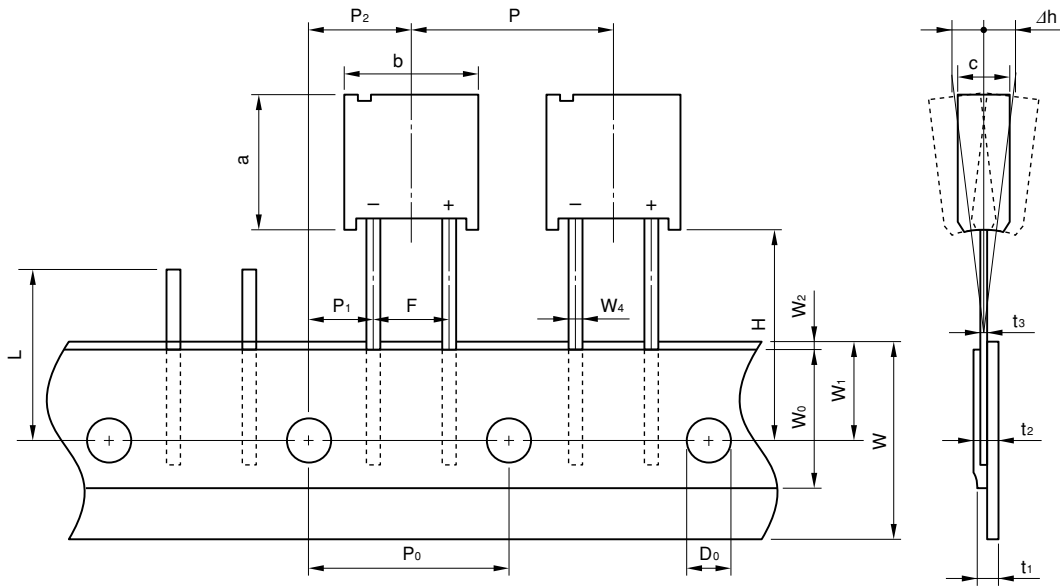

Unit : (mm)

Item	Symbol	Value	Tolerance	Remarks
Component Height	a	11.5	±0.5	
Component Width	b	10.5	±0.5	
Component Thickness	c	—	±0.5	5.5 V type : 5.0/0.010F to 0.047F, 6.5/0.047F 3.5 V type : 5.0/0.047F to 0.10F, 6.5/0.22F FME type : 5.0/0.022F to 0.047F 6.5 V type : 6.5/0.047F, 0.10F FMR type : 6.5/0.047F FMC type : 5.0/0.047F, 6.5/0.10F
Lead-wire Width	W <sub>4</sub>	0.5	±0.1	
Lead-wire Thickness	t <sub>3</sub>	0.4	±0.1	
Pitch between Component	P	12.7	±1.0	
Sprocket Hole Pitch	P <sub>0</sub>	12.7	±0.3	
Sprocket Hole to Lead	P <sub>1</sub>	3.85	±0.7	
Lead Spacing	P <sub>2</sub>	6.35	±1.3	
Lead Spacing	F	5.0	±0.5	
Component Alignment	Δh	2.0 Max.	—	Including tilting caused by bending lead wire.
Tape Width	W	18.0	+1.0 -0.5	
Hold-down tape Width	W <sub>0</sub>	12.5 Min.	—	
Sprocket Hole Position	W <sub>1</sub>	9.0	±0.5	
Hold-down Tape Position	W <sub>2</sub>	3.0 Max.	—	No protrusion of tape.
Component's Bottom Line Position	H	18.0	±0.5	
Sprocket Hole Diameter	D <sub>0</sub>	φ 4.0	±0.2	
Total tape Thickness	t <sub>1</sub>	0.7	±0.2	
Defect Component Cut-off Position	L	11.0 Max.	—	



- All specifications in this catalog and production status of products are subject to change without notice. Prior to the purchase, please contact TOKIN for updated product data.
- Please request for a specification sheet for detailed product data prior to the purchase.
- Before using the product in this catalog, please read "Precautions" and other safety precautions listed in the printed version catalog.

**Taping Specifications [FMC0H334ZFTP 18]**

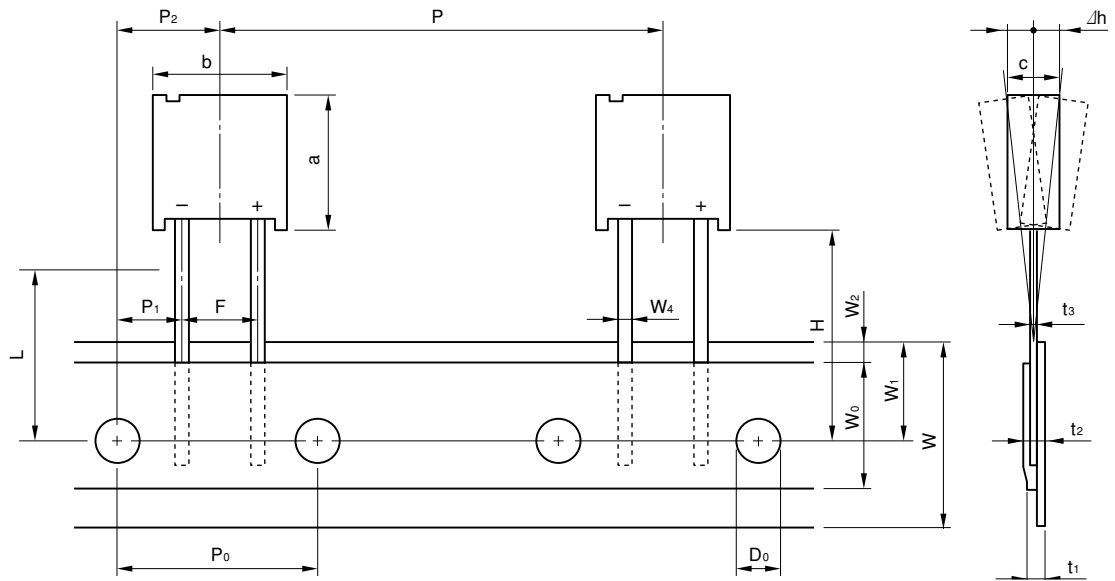

Unit : (mm)

Item	Symbol	Value	Tolerance	Remarks
Component Height	a	15.0	±0.5	
Component Width	b	14.0	±0.5	
Component Thickness	c	9.0	±0.5	
Lead-wire Width	W <sub>4</sub>	0.6	±0.1	
Lead-wire Thickness	t <sub>3</sub>	0.6	±0.1	
Pitch between Component	P	25.4	±1.0	
Sprocket Hole Pitch	P <sub>0</sub>	12.7	±0.3	
Sprocket Hole to Lead	P <sub>1</sub>	3.85	±0.7	
∕	P <sub>2</sub>	6.35	±1.3	
Lead Spacing	F	5.0	±0.5	
Component Alignment	Δh	2.0 Max.	—	Including tilting caused by bending lead wire
Tape Width	W	18.0	+1.0 -0.5	
Hold-down tape Width	W <sub>0</sub>	12.5 Min.	—	
Sprocket Hole Position	W <sub>1</sub>	9.0	±0.5	
Hold-down Tape Position	W <sub>2</sub>	3.0 Max.	—	No protrusion of tape
Component's Bottom Line Position	H	18.0	±0.5	
Sprocket Hole Diameter	D <sub>0</sub>	φ 4.0	±0.2	
Total tape Thickness	t <sub>1</sub>	0.67	±0.2	
∕	t <sub>2</sub>	1.7 Max.	—	
Defect Component Cut-off Position	L	11.0 Max.	—	



- All specifications in this catalog and production status of products are subject to change without notice. Prior to the purchase, please contact TOKIN for updated product data.
- Please request for a specification sheet for detailed product data prior to the purchase.
- Before using the product in this catalog, please read "Precautions" and other safety precautions listed in the printed version catalog.

**Typical Performance Data**

Resistive discharge characteristic (Backup time capability) 5.5V Type

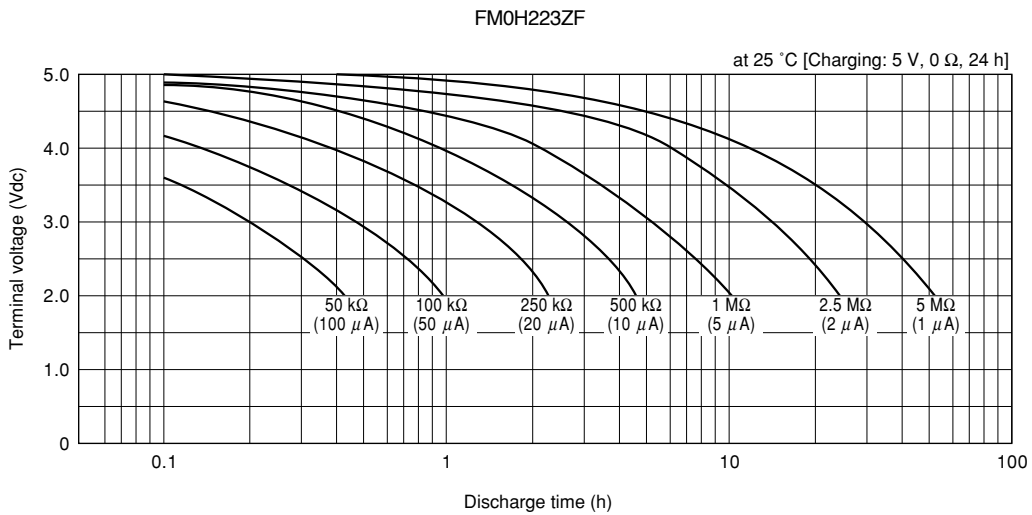
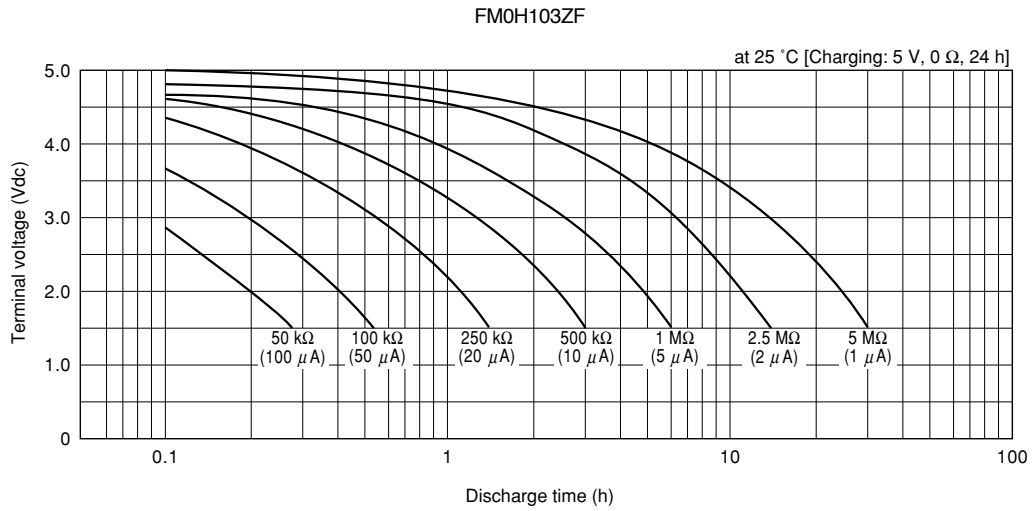

- All specifications in this catalog and production status of products are subject to change without notice. Prior to the purchase, please contact TOKIN for updated product data.
- Please request for a specification sheet for detailed product data prior to the purchase.
- Before using the product in this catalog, please read "Precautions" and other safety precautions listed in the printed version catalog.



**Resistance discharge characteristic (Backup time capability) 5.5V Type**

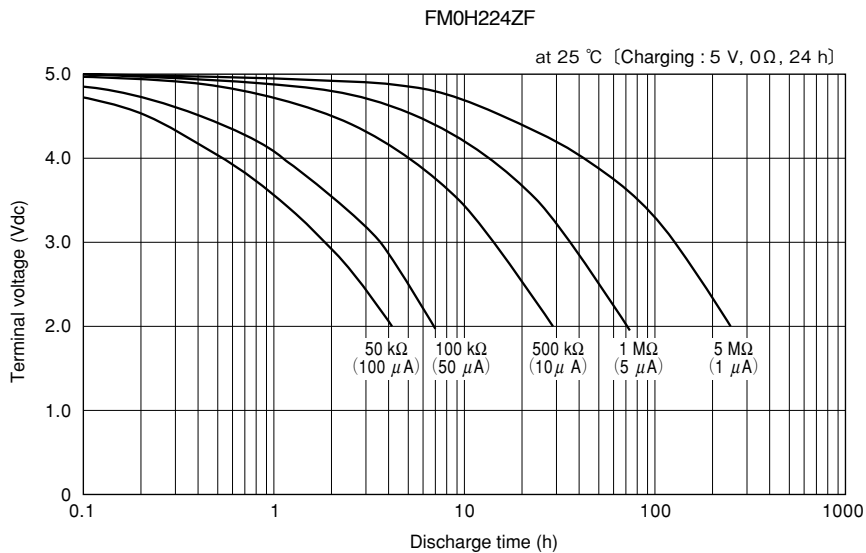
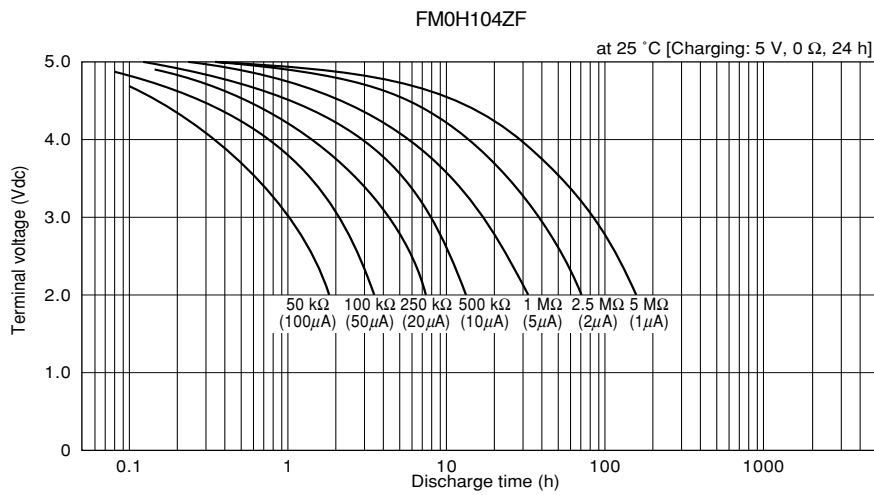
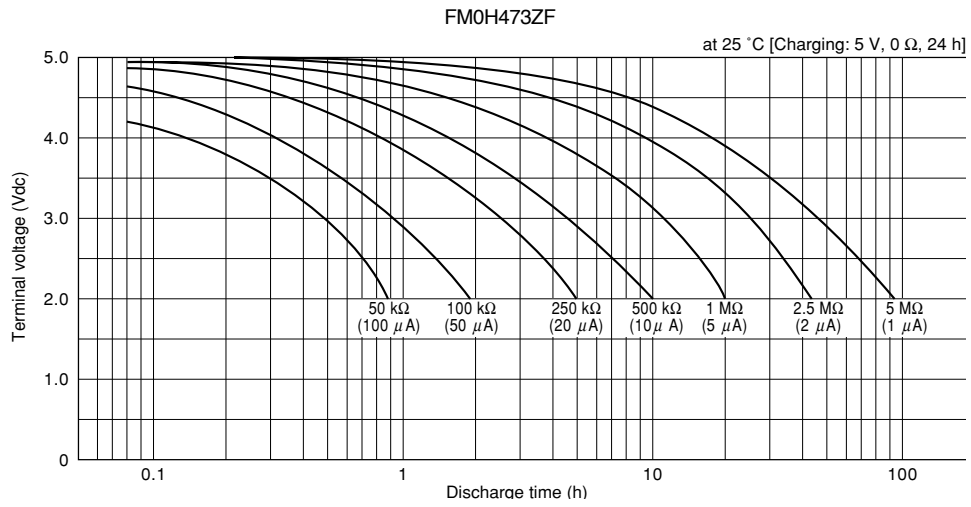

- All specifications in this catalog and production status of products are subject to change without notice. Prior to the purchase, please contact TOKIN for updated product data.
- Please request for a specification sheet for detailed product data prior to the purchase.
- Before using the product in this catalog, please read "Precautions" and other safety precautions listed in the printed version catalog.

**Resistive discharge characteristics (Backup time capability) 3.5 V Type, 6.5V Type**

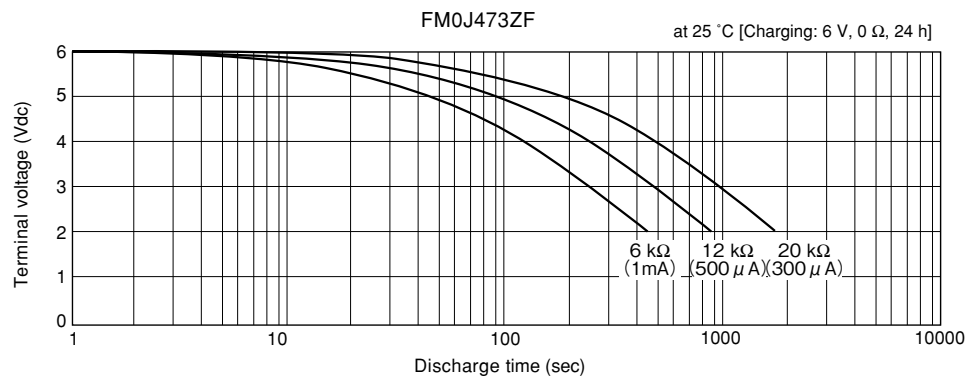
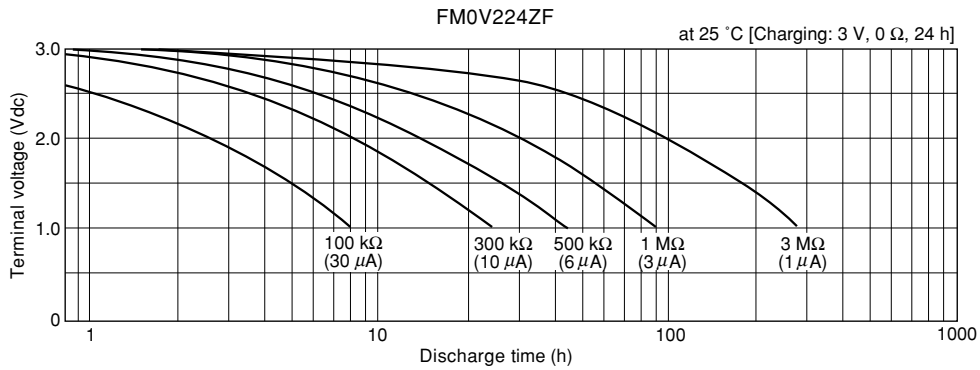
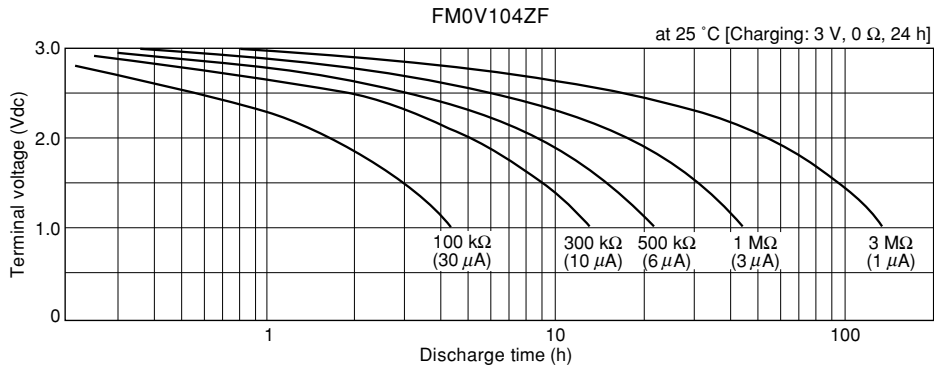
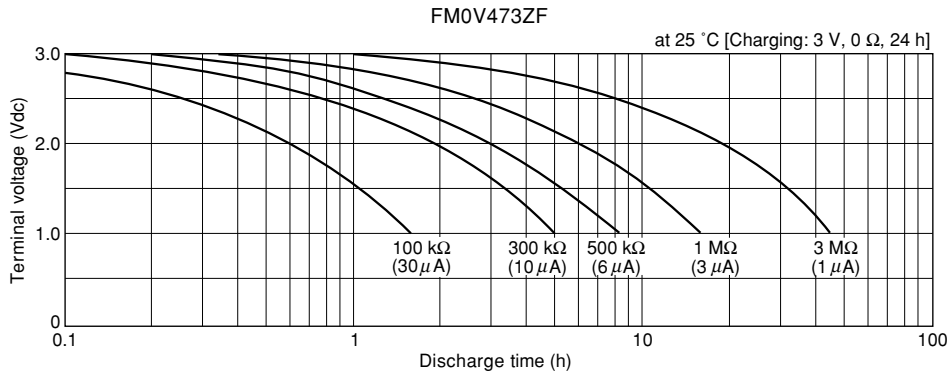

- All specifications in this catalog and production status of products are subject to change without notice. Prior to the purchase, please contact TOKIN for updated product data.
- Please request for a specification sheet for detailed product data prior to the purchase.
- Before using the product in this catalog, please read "Precautions" and other safety precautions listed in the printed version catalog.

**Resistive discharge characteristics (Backup time capability) FME Type**

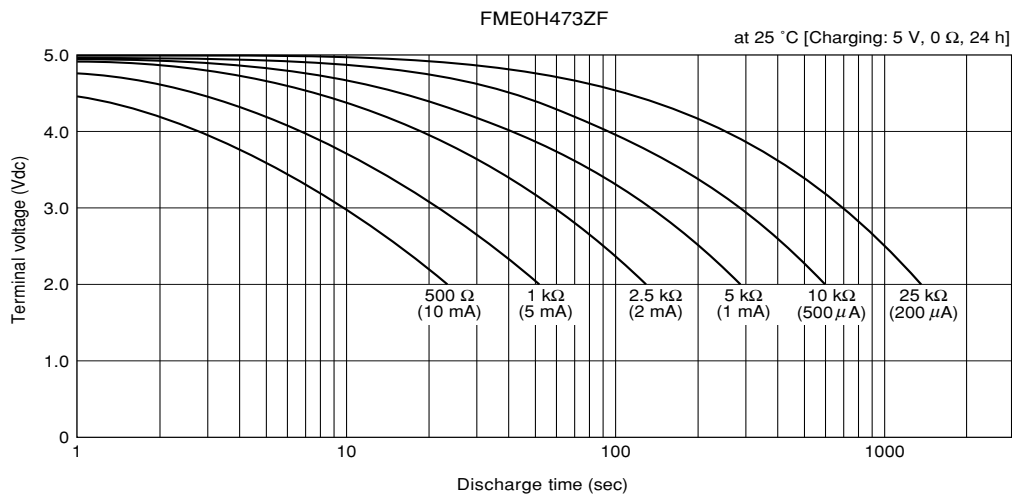
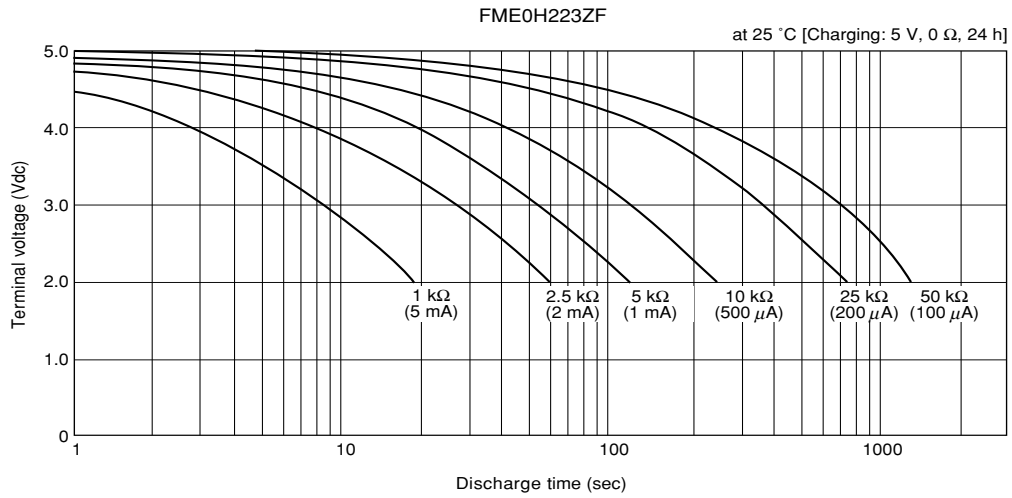

- All specifications in this catalog and production status of products are subject to change without notice. Prior to the purchase, please contact TOKIN for updated product data.
- Please request for a specification sheet for detailed product data prior to the purchase.
- Before using the product in this catalog, please read "Precautions" and other safety precautions listed in the printed version catalog.

**Resistive discharge characteristics (Backup time capability) FMC Type**

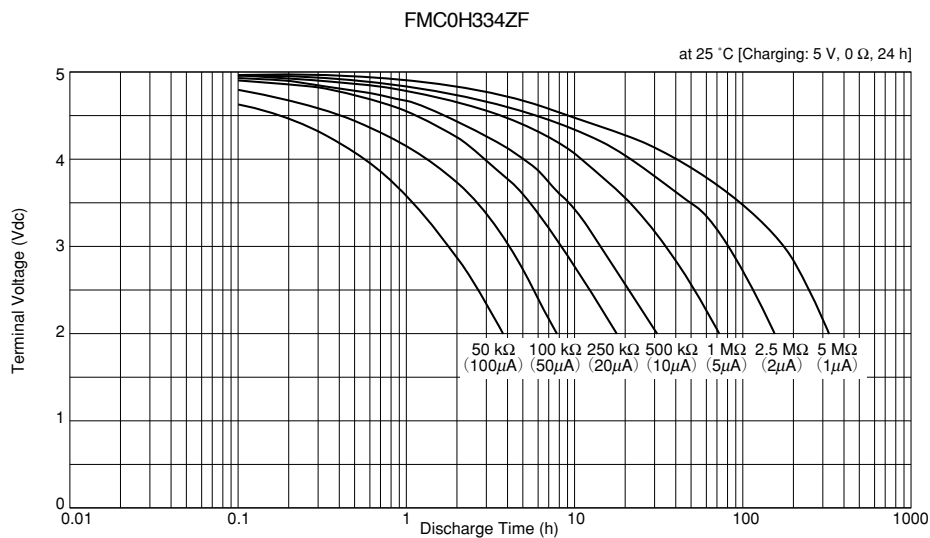
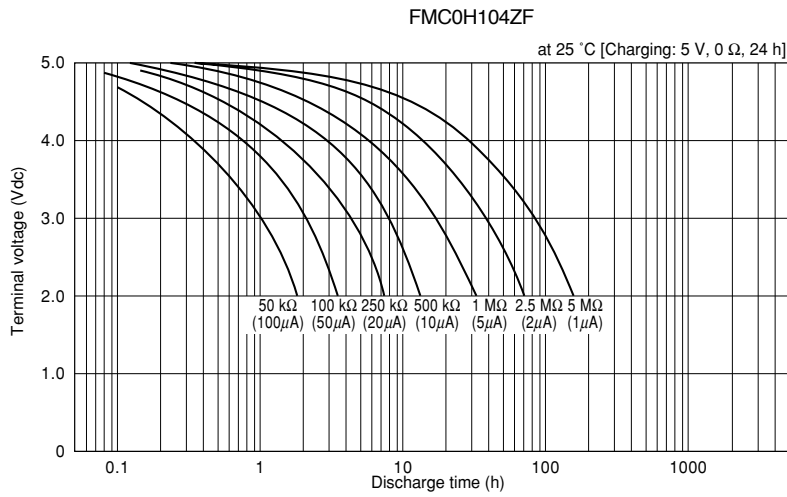
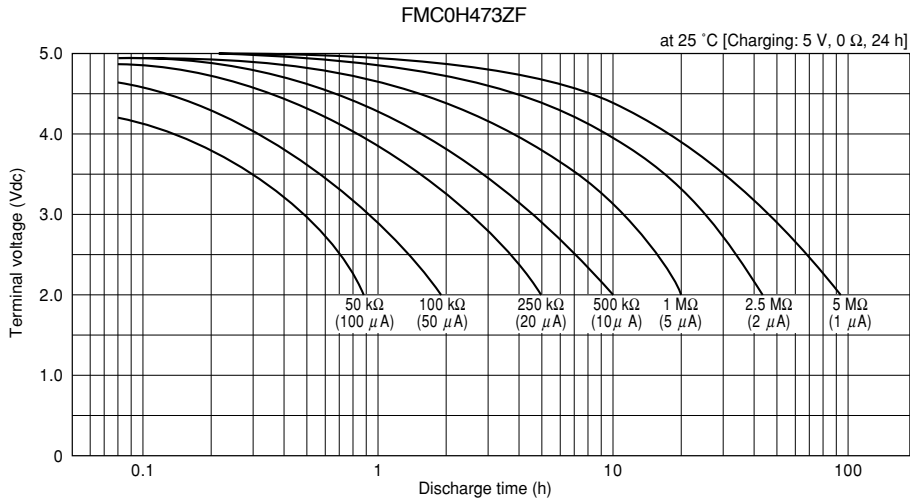

- All specifications in this catalog and production status of products are subject to change without notice. Prior to the purchase, please contact TOKIN for updated product data.
- Please request for a specification sheet for detailed product data prior to the purchase.
- Before using the product in this catalog, please read "Precautions" and other safety precautions listed in the printed version catalog.

# 12

## FG-SERIES SuperCapacitor

(Miniaturized, Large Capacitance) (For cleanable products, see page 28.)

The FG Series SuperCapacitor is a range of compact, large capacitance double-layer capacitors with excellent voltage holding characteristics.

The FG-Series capacitors were designed to provide more compact versions of the FY-Series of capacitors.

Compared with the conventional FY Series, these capacitors provide the same capacitance at approximately half the size.

These capacitors are ideal as long-time backup devices for minute-current loads in small and lightweight systems.

### Features

- The same capacitance at approximately half the size, compared with the FY Series.
- Excellent voltage holding characteristics ideal for backup of 1  $\mu$ A to several hundred  $\mu$ A
- Easily chargeable
- Wide operating range: -25 to +70°C
- Maintenance free.
- Lead-free, PVC-free type. RoHS Compliant.

### Application

Backup of CMOS microcomputers, static RAMs, DTSs (digital tuning systems)

### Part Number System

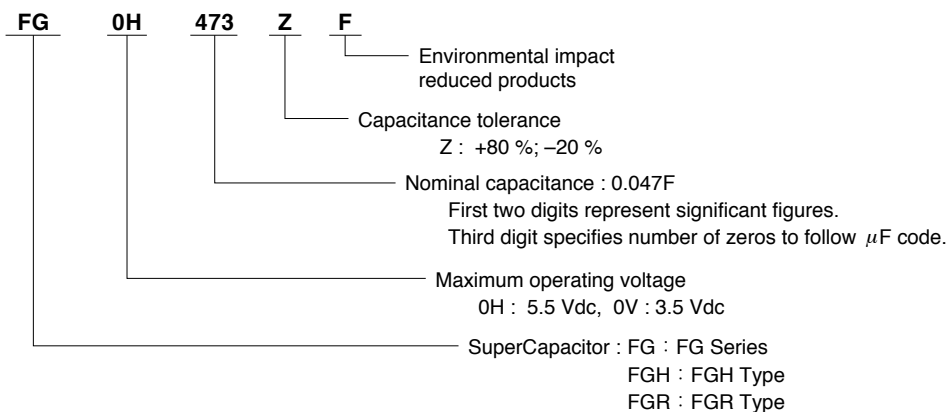

### Markings

Name of manufacturer, maximum operating voltage, capacitance, manufacture date code, serial no., and series name are marked on the external tube. The negative lead terminal is marked with black bands.

Conversion table for manufacture date code

Year	'10	'11	'12	'13	'14	'15	'16	'17	'18	'19	'20	'21
Indication	A	B	C	D	E	F	H	J	K	L	M	N
Month	1	2	3	4	5	6	7	8	9	10	11	12
Indication	1	2	3	4	5	6	7	8	9	O	N	D

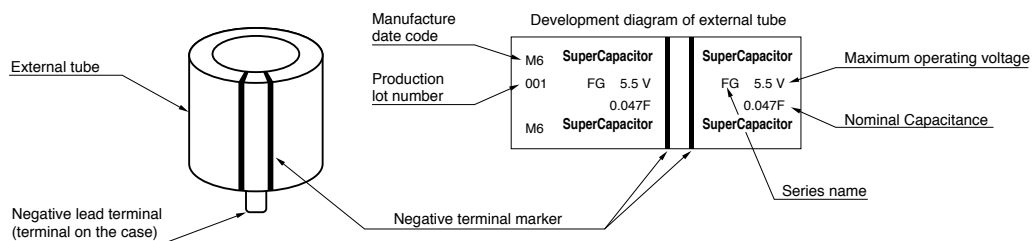

- All specifications in this catalog and production status of products are subject to change without notice. Prior to the purchase, please contact TOKIN for updated product data.
- Please request for a specification sheet for detailed product data prior to the purchase.
- Before using the product in this catalog, please read "Precautions" and other safety precautions listed in the printed version catalog.

**Dimensions**

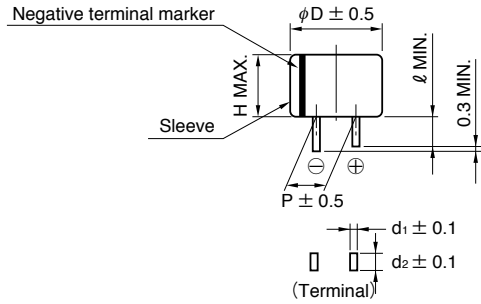

**Standard Ratings**

FG Type													
Part Number	MAX operating voltage (Vdc)	Nominal capacitance		MAX ESR (at 1 kHz) ( $\Omega$ )	MAX current at 30 min. (mA)	Voltage holding characteristics (V)	Dimension (unit:mm)						Weight (g)
		Charge system (F)	Discharge system (F)				$\phi D$	H	P	$\ell$	$d_1$	$d_2$	
FG0H103ZF	5.5	0.010	0.013	300	0.015	4.2	11.0	5.5	5.08	2.7	0.2	1.2	0.9
FG0H223ZF	5.5	0.022	0.028	200	0.033	4.2	11.0	5.5	5.08	2.7	0.2	1.2	1.0
FG0H473ZF	5.5	0.047	0.060	200	0.071	4.2	11.0	5.5	5.08	2.7	0.2	1.2	1.0
FG0H104ZF	5.5	0.10	0.13	100	0.15	4.2	11.0	6.5	5.08	2.7	0.2	1.2	1.3
FG0H224ZF	5.5	0.22	0.28	100	0.33	4.2	13.0	9.0	5.08	2.2	0.4	1.2	2.5
FG0H474ZF	5.5	0.47	0.60	120	0.71	4.2	14.5	18.0	5.08	2.4	0.4	1.2	5.1
FG0H105ZF	5.5	1.0	1.3	65	1.5	4.2	16.5	19.0	5.08	2.7	0.4	1.2	7.0
FG0H225ZF	5.5	2.2	2.8	35	3.3	4.2	21.5	19.0	7.62	3.0	0.6	1.2	12.1
FG0H475ZF	5.5	4.7	6.0	35	7.1	4.2	28.5	22.0	10.16	6.1	0.6	1.4	27.3
FG0V155ZF	3.5	1.5	2.2	65	1.5	-	16.5	14.0	5.08	2.7	0.4	1.2	5.2

FGH Type													
Part Number	MAX operating voltage (Vdc)	Nominal capacitance (F)		MAX ESR (at 1 kHz) ( $\Omega$ )	MAX current at 30 min. (mA)	Voltage holding characteristics (V)	Dimension (unit:mm)						Weight (g)
		$\phi D$	H				P	$\ell$	$d_1$	$d_2$			
FGH0H104ZF	5.5	0.10		100	0.15	4.2	11.0	5.5	5.08	2.7	0.2	1.2	1.0
FGH0H224ZF	5.5	0.22		100	0.33	4.2	11.0	7.0	5.08	2.7	0.2	1.2	1.3
FGH0H474ZF	5.5	0.47		65	0.71	4.2	16.5	8.0	5.08	2.7	0.4	1.2	4.1
FGH0H105ZF	5.5	1.0		35	1.5	4.2	21.5	9.5	7.62	3.0	0.6	1.2	7.2

FGR Type													
Part Number	MAX operating voltage (Vdc)	Nominal capacitance		MAX ESR (at 1 kHz) ( $\Omega$ )	MAX current at 30 min. (mA)	Voltage holding characteristics (V)	Dimension (unit:mm)						Weight (g)
		Charge system (F)	Discharge system (F)				$\phi D$	H	P	$\ell$	$d_1$	$d_2$	
FGR0H474ZF	5.5	0.47	0.60	120	0.71	4.2	14.5	18.0	5.08	2.4	0.4	1.2	5.1
FGR0H105ZF	5.5	1.0	1.3	65	1.5	4.2	16.5	19.0	5.08	2.7	0.4	1.2	7.0
FGR0H225ZF	5.5	2.2	2.8	35	3.3	4.2	21.5	19.0	7.62	3.0	0.6	1.2	12.1



- All specifications in this catalog and production status of products are subject to change without notice. Prior to the purchase, please contact TOKIN for updated product data.
- Please request for a specification sheet for detailed product data prior to the purchase.
- Before using the product in this catalog, please read "Precautions" and other safety precautions listed in the printed version catalog.

**Performance Characteristics**

Item	Series name	FG, FGH type	FGR type	Test conditions (conforming to JIS C 5160-1)
Category temperature range		-25°C to +70°C	-40°C to +85°C	
MAX operating voltage		5.5Vdc, 3.5Vdc	5.5Vdc	
Capacitance		FG : 0.010F to 4.7F FGH : 0.10F to 1.0F	0.47F to 2.2F	Refer to "Measurement Conditions"
Capacitance allowance		+80% , -20%	+80% , -20%	Refer to "Measurement Conditions"
ESR		Refer to standard ratings	Refer to standard ratings	Measured at 1kHz, 10mA ; See also "Measurement Conditions"
Current (30-minutes value)		Refer to standard ratings	Refer to standard ratings	Refer to "Measurement Conditions"
Surge	Capacitance	More than 90% of initial specified value	More than 90% of initial specified value	Surge voltage : 6.3V (5.5V type) : 4.0V(3.5V type) Charge : 30 sec. Discharge : 9min 30sec. Number of cycles : 1000 Series resistance : 0.010F 1500 Ω : 0.022F 560 Ω : 0.047F 300 Ω : 0.10F 150 Ω : 0.22F 56 Ω : 0.47F 30 Ω : 1.0F, 1.5F 15 Ω : 2.2F, 4.7F 10 Ω Discharge resistance : 0 Ω Temperature : 85±2°C (FGR) : 70±2°C (FG, FGH)
	ESR	Less than 120% of initial specified value	Less than 120% of initial specified value	
	Current (30 minutes value)	Less than 120% of initial specified value	Less than 120% of initial specified value	
	Appearance	No obvious abnormality	No obvious abnormality	
Characteristics in different temperature	Capacitance	Phase 2 More than 50% of initial measured value Less than 400% of initial measured value	Phase 2 More than 50% of initial measured value Less than 400% of initial measured value	Conforms to 4.17 Phase1 : +25±2°C Phase2 : -25±2°C Phase3 : -40±2°C (FGR) Phase4 : +25±2°C Phase5 : +70±2°C (FG, FGH) : +85±2°C (FGR) Phase6 : +25±2°C
	ESR		Phase 2 More than 30% of initial measured value Less than 700% of initial measured value	
	Capacitance	Phase 3 Less than 200% of initial measured value Satisfy initial specified value	Phase 3 Less than 200% of initial measured value Satisfy initial specified value	
	ESR		Phase 3 Less than 200% of initial measured value Satisfy initial specified value	
	Capacitance	Phase 5 Within ±20% of initial measured value Satisfy initial specified value	Phase 5 Within ±20% of initial measured value Satisfy initial specified value	
	ESR		Phase 5 Within ±20% of initial measured value Satisfy initial specified value	
	Current (30 minutes value)	Phase 6 1.5CV (mA) or below	Phase 6 1.5CV (mA) or below	
	Capacitance		Phase 6 Within ±20% of initial measured value Satisfy initial specified value	
ESR	Phase 6 Satisfy initial specified value	Phase 6 Satisfy initial specified value		
Current (30 minutes value)	Phase 6 Satisfy initial specified value	Phase 6 Satisfy initial specified value		
Lead strength (tensile)		No terminal damage	No terminal damage	Conforms to 4.9
Vibration resistance	Capacitance	Satisfy initial specified value	Satisfy initial specified value	Conforms to 4.13 Frequency : 10 to 55 Hz Testing time : 6 hours
	ESR			
	Current (30 minutes value)	No obvious abnormality	No obvious abnormality	
	Appearance			
Solderability		Over 3/4 of the terminal should be covered by the new solder	Over 3/4 of the terminal should be covered by the new solder	Conforms to 4.11 Solder temp : 245±5°C Dipping time : 5±0.5 sec. 1.6mm from the bottom should be dipped.
Solder heat resistance	Capacitance	Satisfy initial specified value	Satisfy initial specified value	Conforms to 4.10 Solder temp : 260±10°C Dipping time : 10±1 sec. 1.6mm from the bottom should be dipped.
	ESR			
	Current (30 minutes value)	No obvious abnormality	No obvious abnormality	
	Appearance			
Temperature cycle	Capacitance	Satisfy initial specified value	Satisfy initial specified value	Conforms to 4.12 Temperature condition : Category MIN temp → Room temp → Category MAX temp → Room temp Number of cycles : 5 Cycles
	ESR			
	Current (30 minutes value)	No obvious abnormality	No obvious abnormality	
	Appearance			
High temp. and high humidity resistance	Capacitance	Within ±20% of initial measured value	Within ±20% of initial measured value	Conforms to 4.14 Temperature : 40±2°C Relative humidity : 90 to 95% RH Testing time : 240±8 hours
	ESR	Less than 120% of initial specified value	Less than 120% of initial specified value	
	Current (30 minutes value)	Less than 120% of initial specified value	Less than 120% of initial specified value	
	Appearance	No obvious abnormality	No obvious abnormality	
High temperature load	Capacitance	Within ±30% of initial measured value	Within ±30% of initial measured value	Conforms to 4.15 Temp : Category MAX temp ±2°C Voltage applied : MAX operating voltage Series protection resistance : 0 Ω Testing time : 1000 <sup>±8</sup> Hours
	ESR	Less than 200% of initial specified value	Less than 200% of initial specified value	
	Current (30 minutes value)	Less than 200% of initial specified value	Less than 200% of initial specified value	
	Appearance	No obvious abnormality	No obvious abnormality	
Self discharge characteristics (voltage holding characteristics)		5.5V type: Voltage between terminal leads higher than 4.2V 3.5V type: Not specified	Voltage between terminal leads higher than 4.2V	Charging condition Voltage applied : 5.0Vdc (Terminal at the case's side be negative) Series resistance : 0 Ω Charging time : 24 hours
				Storage Let stand for 24 hours in condition described below with terminals opened. Ambient temperature : Lower than 25°C Relative humidity : Lower than 70%RH



- All specifications in this catalog and production status of products are subject to change without notice. Prior to the purchase, please contact TOKIN for updated product data.
- Please request for a specification sheet for detailed product data prior to the purchase.
- Before using the product in this catalog, please read "Precautions" and other safety precautions listed in the printed version catalog.

**Typical Performance Data**

**Resistive discharge characteristics (Backup time capability)**

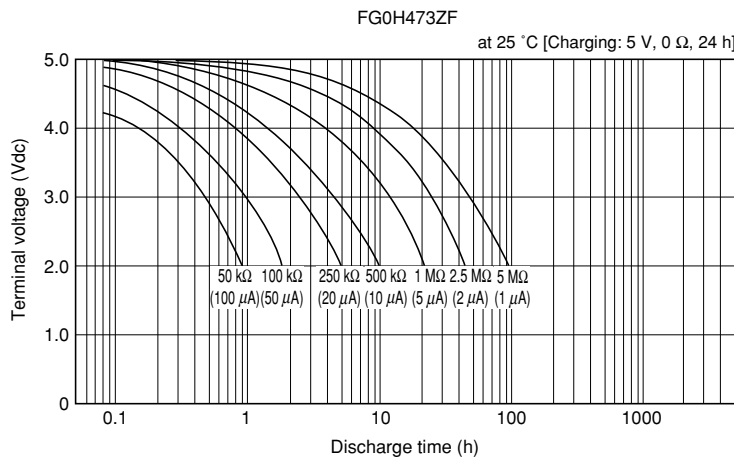
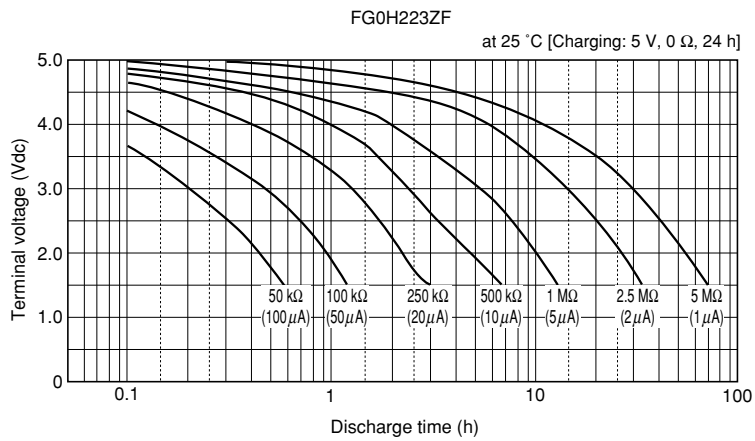
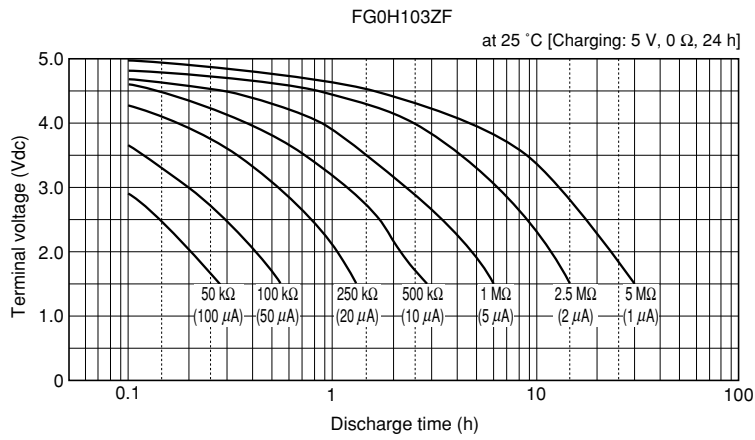

- All specifications in this catalog and production status of products are subject to change without notice. Prior to the purchase, please contact TOKIN for updated product data.
- Please request for a specification sheet for detailed product data prior to the purchase.
- Before using the product in this catalog, please read "Precautions" and other safety precautions listed in the printed version catalog.



**Resistive discharge characteristics (Backup time capability)**

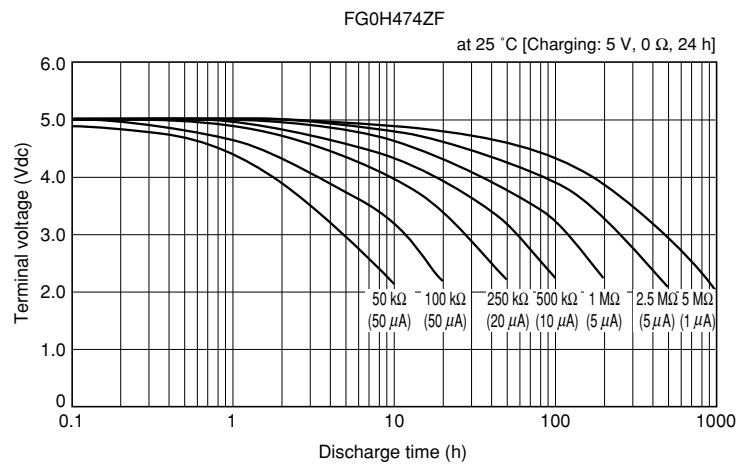
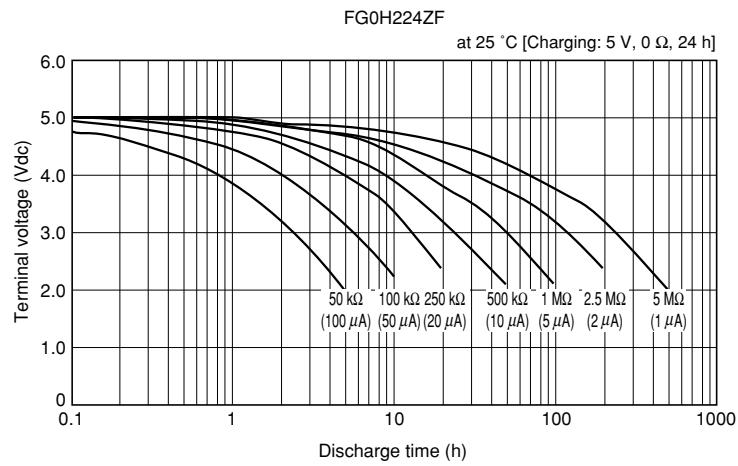
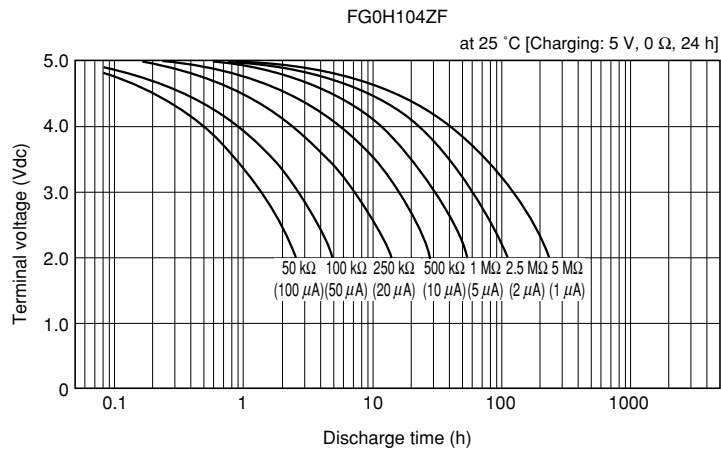

- All specifications in this catalog and production status of products are subject to change without notice. Prior to the purchase, please contact TOKIN for updated product data.
- Please request for a specification sheet for detailed product data prior to the purchase.
- Before using the product in this catalog, please read "Precautions" and other safety precautions listed in the printed version catalog.

**Resistive discharge characteristics (Backup time capability)**

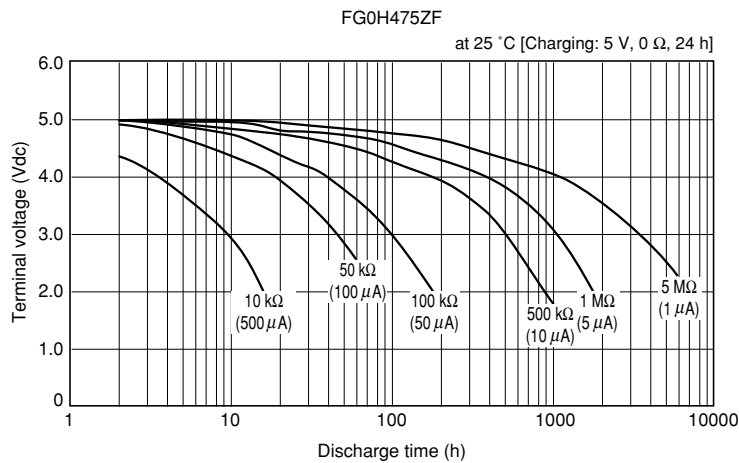
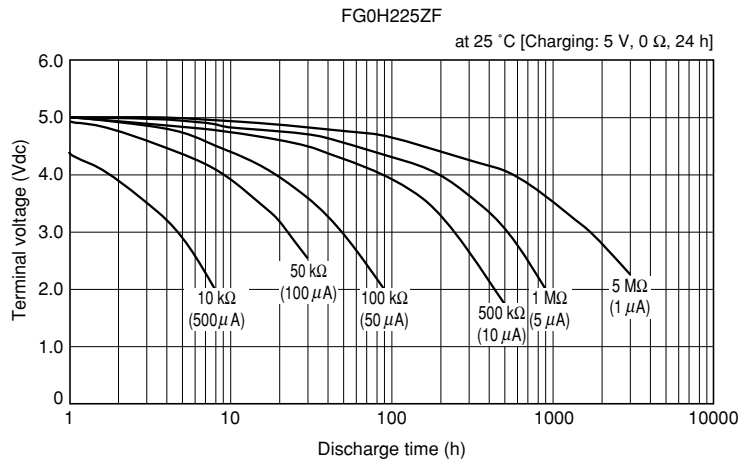
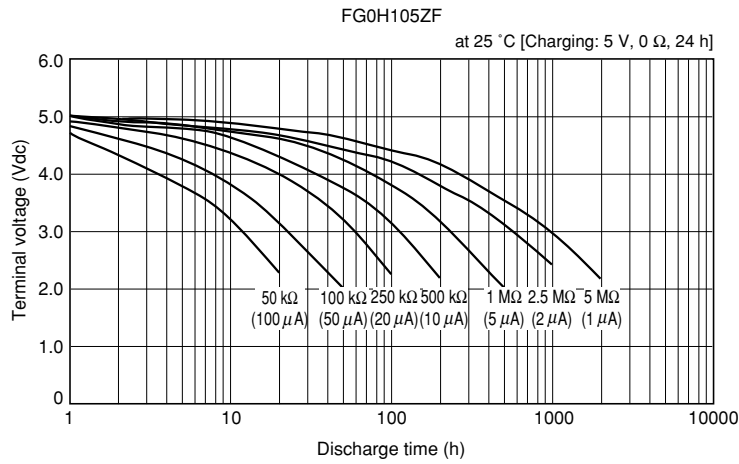

- All specifications in this catalog and production status of products are subject to change without notice. Prior to the purchase, please contact TOKIN for updated product data.
- Please request for a specification sheet for detailed product data prior to the purchase.
- Before using the product in this catalog, please read "Precautions" and other safety precautions listed in the printed version catalog.

Resistive discharge characteristics (Backup time capability) FGH Type

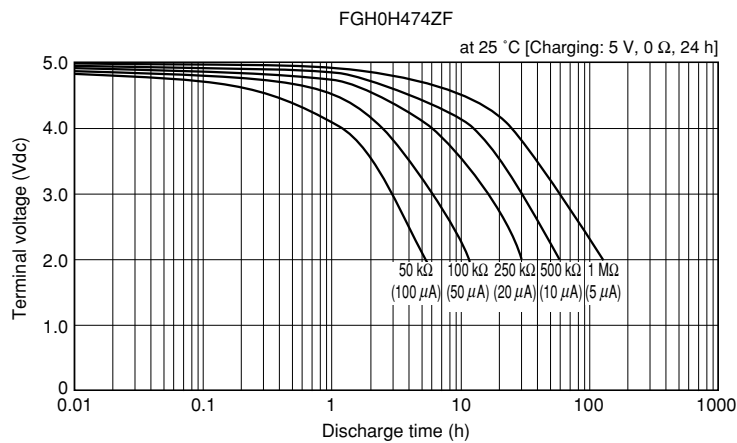
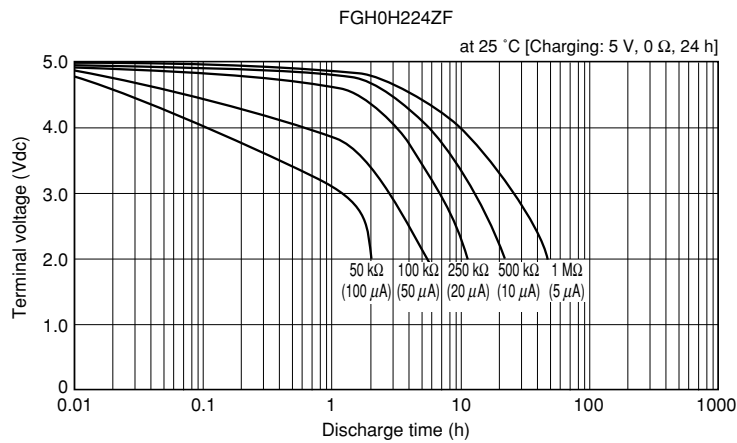
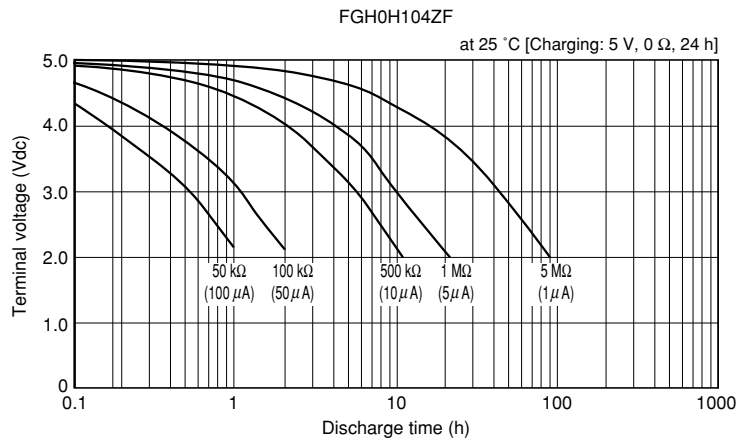

- All specifications in this catalog and production status of products are subject to change without notice. Prior to the purchase, please contact TOKIN for updated product data.
- Please request for a specification sheet for detailed product data prior to the purchase.
- Before using the product in this catalog, please read "Precautions" and other safety precautions listed in the printed version catalog.

Resistive discharge characteristics (Backup time capability) FGH Type

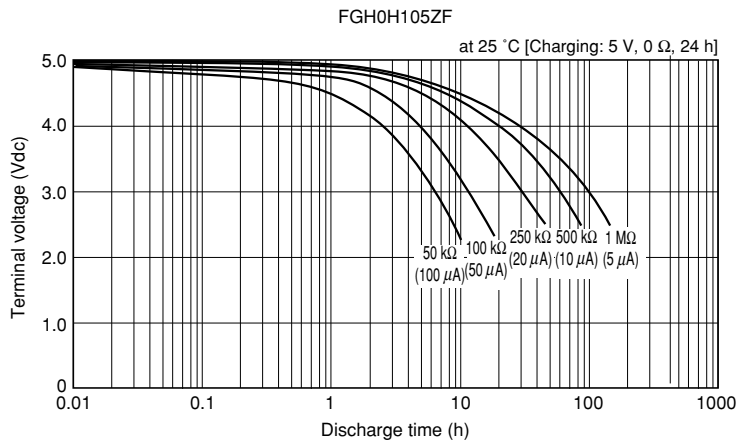

- All specifications in this catalog and production status of products are subject to change without notice. Prior to the purchase, please contact TOKIN for updated product data.
- Please request for a specification sheet for detailed product data prior to the purchase.
- Before using the product in this catalog, please read "Precautions" and other safety precautions listed in the printed version catalog.

# 13

## FT-SERIES SuperCapacitor (Miniaturized, Low ESR)

FT Series SuperCapacitors are backup devices adaptable to current consumption levels ranging from several hundred  $\mu A$  to several hundred mA. These products are developed for the purpose of miniaturizing conventional FS Series capacitors with ESR equal to the size half of the FS Series.

### Features

- Half the size of the FS Series, and ESR and capacitance equal to the FS Series
- Surface mounting possible
- Wide range of temperature from  $-40^{\circ}C$  to  $+85^{\circ}C$
- Maintenance free
- Lead-free, PVC-free type. RoHS Compliant.

### Application

Designed to be used for products such as personal computers, PBXs, telephone sets, and HDDs with circuits that need backup of mA level current.

### Markings

Name of manufacturer, maximum operating voltage, nominal capacitance, manufacturing date code, serial number, and series name are marked on the external tube. The negative lead terminal is marked with a black band.

### Part Number System

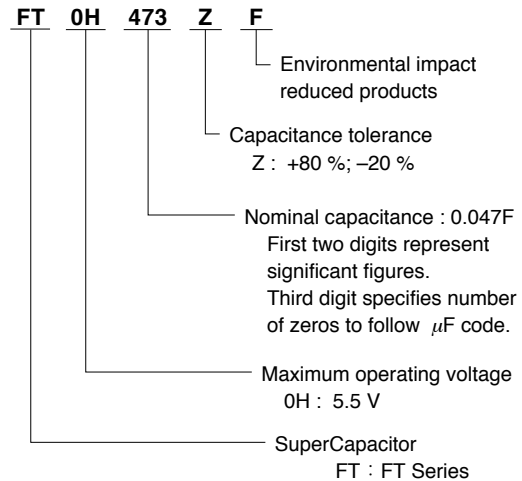

Conversion table for manufacture date code

Year	'10	'11	'12	'13	'14	'15	'16	'17	'18	'19	'20	'21
Indication	A	B	C	D	E	F	H	J	K	L	M	N
Month	1	2	3	4	5	6	7	8	9	10	11	12
Indication	1	2	3	4	5	6	7	8	9	O	N	D

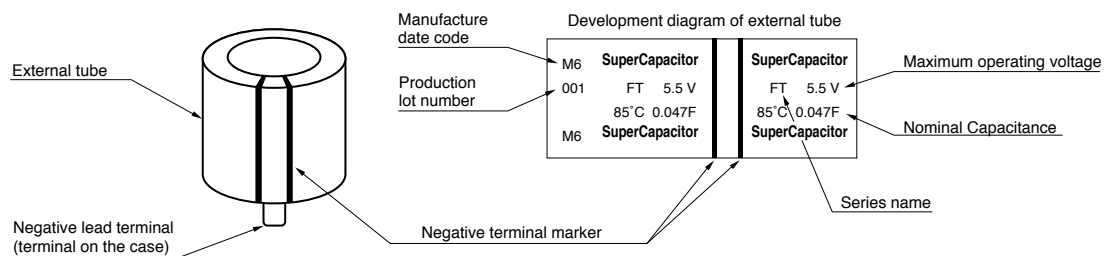

- All specifications in this catalog and production status of products are subject to change without notice. Prior to the purchase, please contact TOKIN for updated product data.
- Please request for a specification sheet for detailed product data prior to the purchase.
- Before using the product in this catalog, please read "Precautions" and other safety precautions listed in the printed version catalog.

## Dimensions

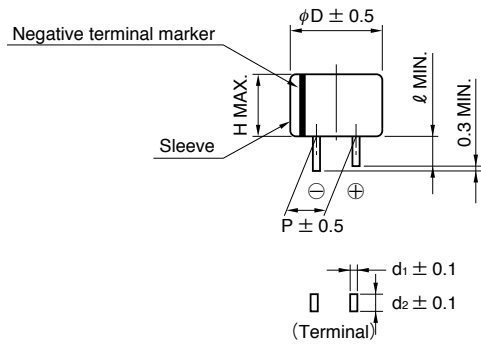

## Standard Ratings

Part Number	MAX operating voltage (Vdc)	Nominal capacitance		MAX ESR (at 1 kHz) ( $\Omega$ )	MAX current at 30 min. (mA)	Dimension (unit:mm)						Weight (g)
		Charge system (F)	Discharge system (F)			$\phi D$	H	P	$d_1$	$d_2$	$\ell$	
FT0H104ZF	5.5	0.10	0.14	16	0.15	11.5	8.5	5.08	0.4	1.2	2.7	1.6
FT0H224ZF	5.5	0.22	0.28	10	0.33	14.5	12.0	5.08	0.4	1.2	2.2	4.1
FT0H474ZF	5.5	0.47	0.60	6.5	0.71	16.5	13.0	5.08	0.4	1.2	2.7	5.3
FT0H105ZF	5.5	1.0	1.3	3.5	1.5	21.5	13.0	7.62	0.6	1.2	3.0	10.0
FT0H225ZF	5.5	2.2	2.8	1.8	3.3	28.5	14.0	10.16	0.6	1.4	6.1	18.0
FT0H335ZF	5.5	3.3	4.2	1.0	5.0	36.5	15.0	15.00	0.6	1.7	6.1	38.0
FT0H565ZF	5.5	5.6	7.2	0.6	8.4	44.5	17.0	20.00	1.0	1.4	6.1	72.0



- All specifications in this catalog and production status of products are subject to change without notice. Prior to the purchase, please contact TOKIN for updated product data.
- Please request for a specification sheet for detailed product data prior to the purchase.
- Before using the product in this catalog, please read "Precautions" and other safety precautions listed in the printed version catalog.

**Performance Characteristics**

Item	Series name	FT type		Test conditions (conforming to JIS C 5160-1)
Category temperature range		-40°C to +85°C		
MAX operating voltage		5.5Vdc		
Capacitance		0.1F to 5.6F		Refer to "Measurement Conditions"
Capacitance allowance		+80% , -20%		Refer to "Measurement Conditions"
ESR		Refer to standard ratings		Measured at 1kHz, 10mA ; See also "Measurement Conditions"
Current (30-minutes value)		Refer to standard ratings		Refer to "Measurement Conditions"
Surge	Capacitance	More than 90% of initial specified value		Surge voltage : 6.3V Charge : 30 sec. Discharge : 9min 30sec. Number of cycles : 1000 Series resistance : 0.10F 150Ω : 0.22F 56Ω : 0.47F 30Ω : 1.0F 15Ω : 2.2F 10Ω : 3.3F 10Ω : 5.6F 10Ω  Discharge resistance : 0Ω Temperature : 85±2°C
	ESR	Less than 120% of initial specified value		
	Current (30 minutes value)	Less than 120% of initial specified value		
	Appearance	No obvious abnormality		
Characteristics in different temperature	Capacitance	Phase 2	More than 50% of initial measured value	Conforms to 4.17 Phase1 : +25±2°C Phase2 : -25±2°C Phase3 : -40±2°C Phase4 : +25±2°C Phase5 : +85±2°C Phase6 : +25±2°C
	ESR		Less than 300% of initial measured value	
	Capacitance	Phase 3	More than 30% of initial measured value	
	ESR		Less than 700% of initial measured value	
	Capacitance	Phase 5	Less than 150% of initial measured value	
	ESR		Satisfy initial specified value	
	Current (30 minutes value)		1.5CV (mA) or below	
	Capacitance	Phase 6	Within ±20% of initial measured value	
	ESR		Satisfy initial specified value	
Current (30 minutes value)	Satisfy initial specified value			
Lead strength (tensile)		No terminal damage		Conforms to 4.9
Vibration resistance	Capacitance	Satisfy initial specified value		Conforms to 4.13 Frequency : 10 to 55 Hz Testing time : 6 hours
	ESR			
	Current (30 minutes value)			
	Appearance	No obvious abnormality		
Solderability		Over 3/4 of the terminal should be covered by the new solder		Conforms to 4.11 Solder temp : 245±5°C Dipping time : 5±0.5 sec. 1.6mm from the bottom should be dipped.
Solder heat resistance	Capacitance	Satisfy initial specified value		Conforms to 4.10 Solder temp : 260±10°C Dipping time : 10±1 sec. 1.6mm from the bottom should be dipped.
	ESR			
	Current (30 minutes value)			
	Appearance	No obvious abnormality		
Temperature cycle	Capacitance	Satisfy initial specified value		Conforms to 4.12 Temperature condition : -40°C → Room temperature → +85°C → Room temperature Number of cycles : 5 Cycles
	ESR			
	Current (30 minutes value)			
	Appearance	No obvious abnormality		
High temp. and high humidity resistance	Capacitance	Within ±20% of initial measured value		Conforms to 4.14 Temperature : 40±2°C Relative humidity : 90 to 95% RH Testing time : 240±8 hours
	ESR	Less than 120% of initial specified value		
	Current (30 minutes value)	Less than 120% of initial specified value		
	Appearance	No obvious abnormality		
High temperature load	Capacitance	Within ±30% of initial measured value		Conforms to 4.15 Temperature : 85±2°C Voltage applied : MAX operating voltage Series protection resistance : 0Ω Testing time : 1000 <sup>±8</sup> Hours
	ESR	Less than 200% of initial specified value		
	Current (30 minutes value)	Less than 200% of initial specified value		
	Appearance	No obvious abnormality		



- All specifications in this catalog and production status of products are subject to change without notice. Prior to the purchase, please contact TOKIN for updated product data.
- Please request for a specification sheet for detailed product data prior to the purchase.
- Before using the product in this catalog, please read "Precautions" and other safety precautions listed in the printed version catalog.

**Typical Performance Data**

**Resistance discharge characteristic (Backup time capability)**

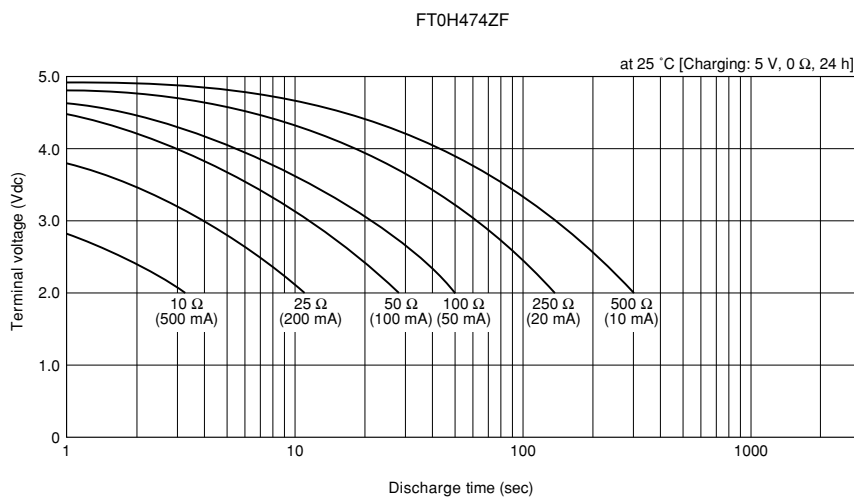
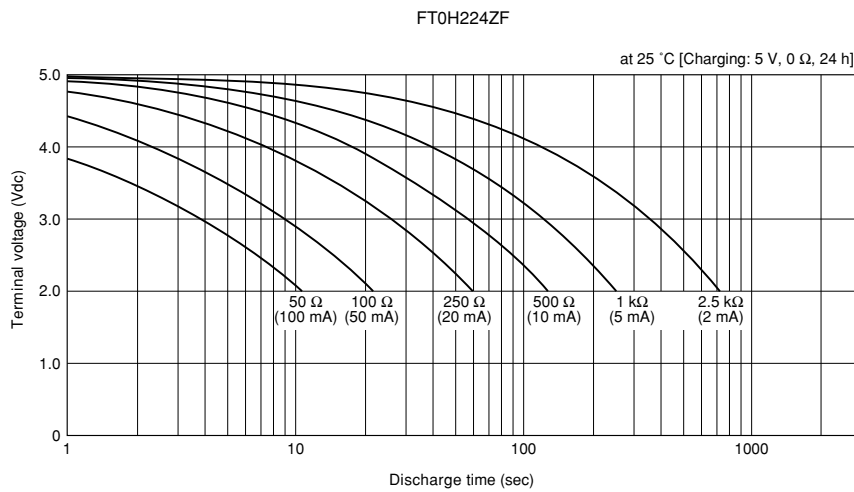
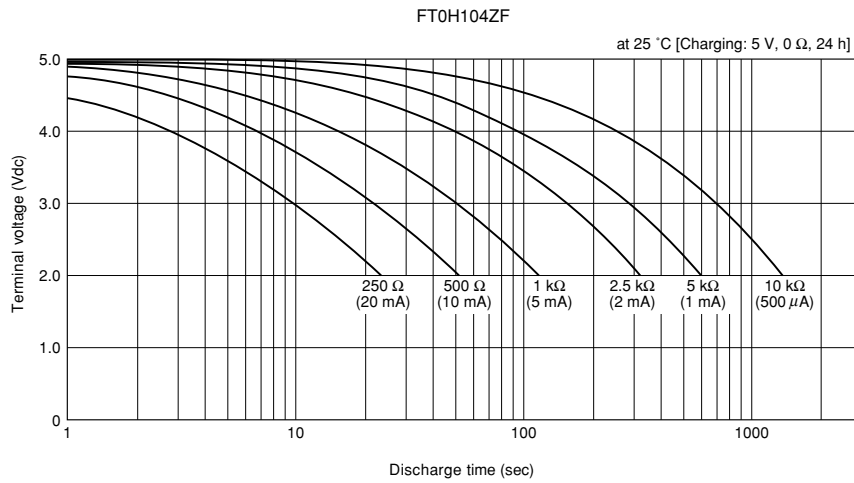

- All specifications in this catalog and production status of products are subject to change without notice. Prior to the purchase, please contact TOKIN for updated product data.
- Please request for a specification sheet for detailed product data prior to the purchase.
- Before using the product in this catalog, please read "Precautions" and other safety precautions listed in the printed version catalog.



**Resistance discharge characteristic (Backup time capability)**

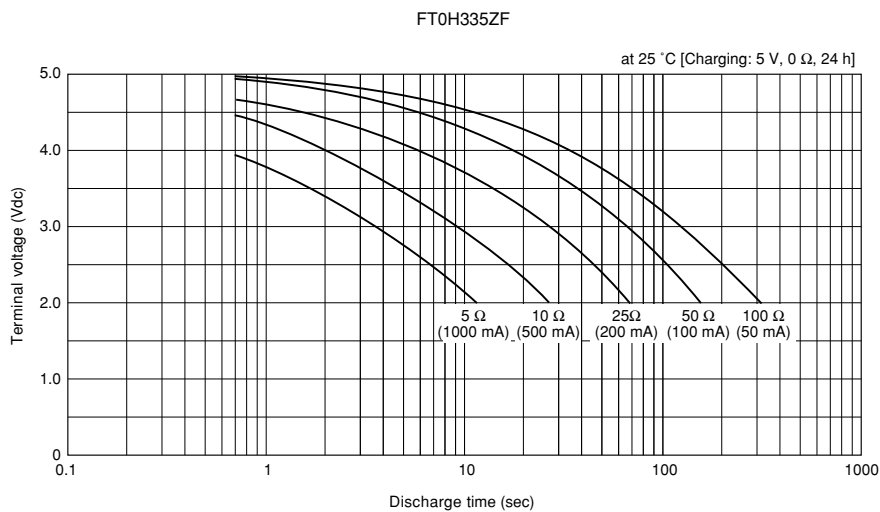
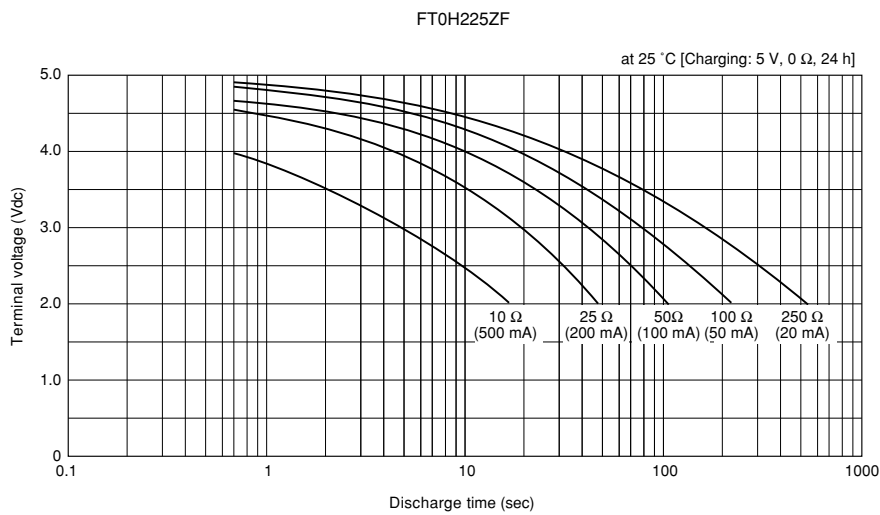
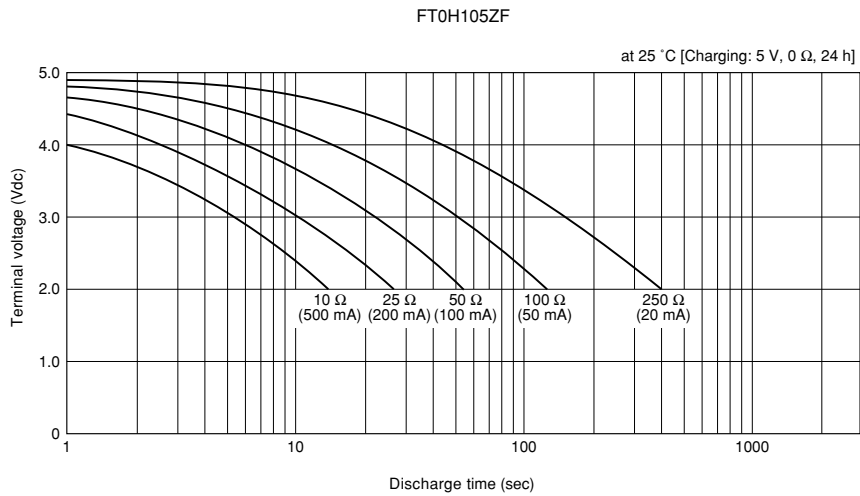

- All specifications in this catalog and production status of products are subject to change without notice. Prior to the purchase, please contact TOKIN for updated product data.
- Please request for a specification sheet for detailed product data prior to the purchase.
- Before using the product in this catalog, please read "Precautions" and other safety precautions listed in the printed version catalog.

**Resistance discharge characteristic (Backup time capability)**

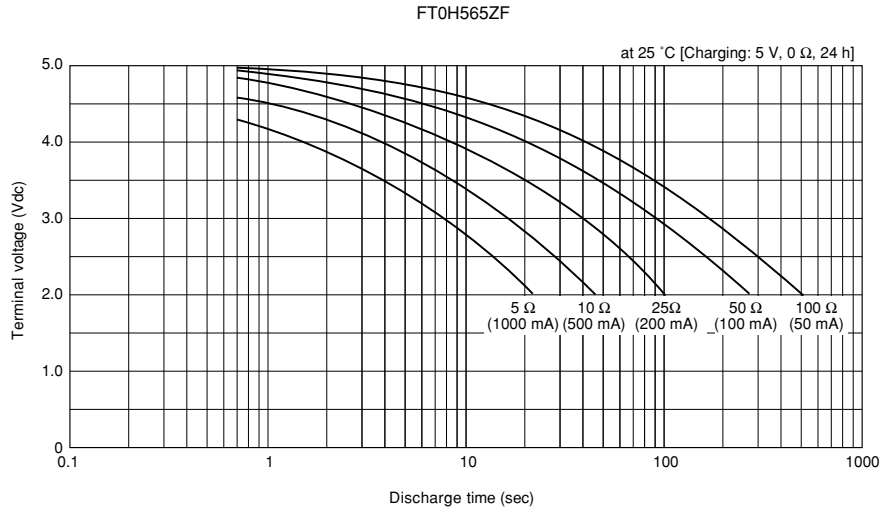

- All specifications in this catalog and production status of products are subject to change without notice. Prior to the purchase, please contact TOKIN for updated product data.
- Please request for a specification sheet for detailed product data prior to the purchase.
- Before using the product in this catalog, please read "Precautions" and other safety precautions listed in the printed version catalog.

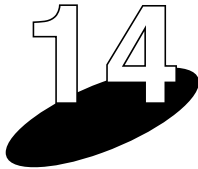

# FY-SERIES SuperCapacitor

(Miniaturized, Large Capacitance) (For cleanable products, see page 28.)

The FY Series includes small-sized electric double-layer capacitors with excellent voltage holding characteristics. The FYD type occupies only a small area on a printed circuit board, and the FYH types feature a low profile in height, so that they can be used in various systems.

These capacitors are ideal as long-time backup devices for minute-current loads in small and lightweight systems.

### Features

- Product variety makes the FYD, and FYH types suitable for use in many types of application systems
- Excellent voltage holding characteristics ideal for backup of 1  $\mu$ A to several hundred  $\mu$ A
- Easily chargeable
- Wide operating range: -25 to +70°C
- Maintenance free.
- Lead-free, PVC-free type. RoHS Compliant.

### Application

Backup of CMOS microcomputers, static RAMs, DTSs (digital tuning systems)

### Part Number System

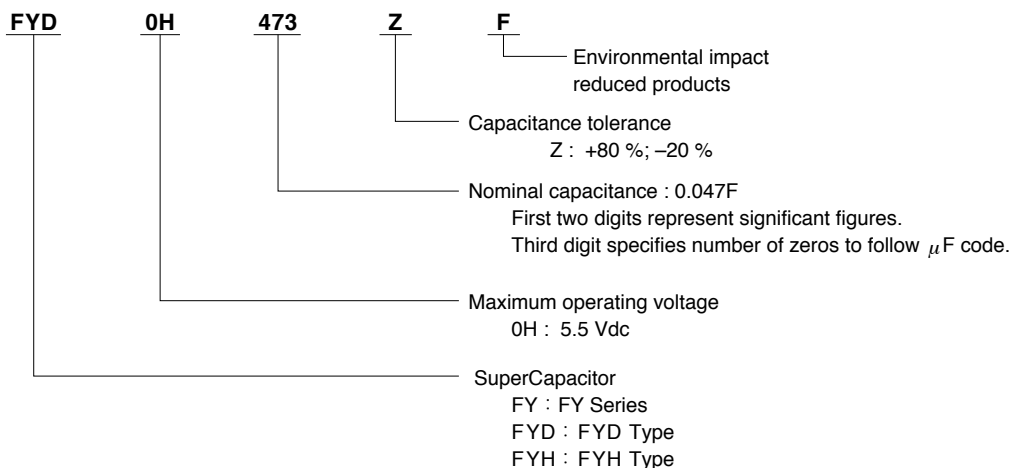

### Markings

Name of manufacturer, maximum operating voltage, capacitance, manufacture date code, serial no., and series name are marked on the external tube. The negative lead terminal is marked with black bands.

Conversion table for manufacture date code

Year	'2010	'11	'12	'13	'14	'15	'16	'17	'18	'19	'20	'21
Indication	A	B	C	D	E	F	H	J	K	L	M	N
Month	1	2	3	4	5	6	7	8	9	10	11	12
Indication	1	2	3	4	5	6	7	8	9	O	N	D

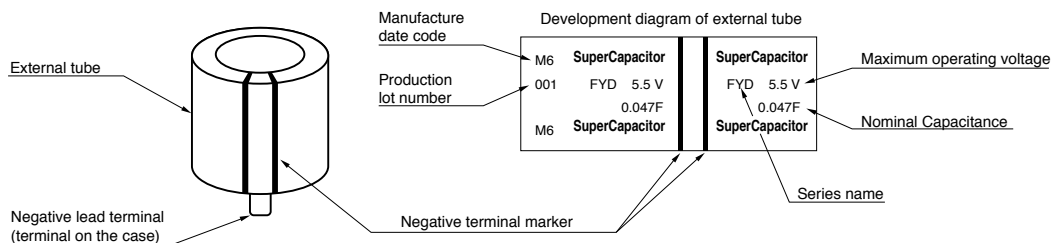

- All specifications in this catalog and production status of products are subject to change without notice. Prior to the purchase, please contact TOKIN for updated product data.
- Please request for a specification sheet for detailed product data prior to the purchase.
- Before using the product in this catalog, please read "Precautions" and other safety precautions listed in the printed version catalog.

## Dimensions

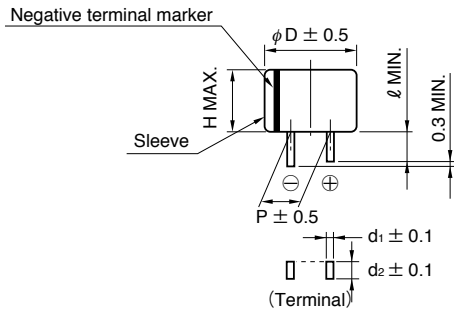

## Standard Ratings

FYD Type													
Part Number	MAX operating voltage (Vdc)	Nominal capacitance		MAX ESR (at 1 kHz) ( $\Omega$ )	MAX current at 30 min. (mA)	Voltage holding characteristics (V)	Dimension (unit:mm)						Weight (g)
		Charge system (F)	Discharge system (F)				$\phi D$	H	P	$\ell$	$d_1$	$d_2$	
FYD0H223ZF	5.5	0.022	0.033	220	0.033	4.2	11.5	8.5	5.08	2.7	0.4	1.2	1.6
FYD0H473ZF	5.5	0.047	0.070	220	0.071	4.2	11.5	8.5	5.08	2.7	0.4	1.2	1.7
FYD0H104ZF	5.5	0.10	0.14	100	0.15	4.2	13.0	8.5	5.08	2.2	0.4	1.2	2.4
FYD0H224ZF	5.5	0.22	0.35	120	0.33	4.2	14.5	15.0	5.08	2.4	0.4	1.2	4.3
FYD0H474ZF	5.5	0.47	0.75	65	0.71	4.2	16.5	15.0	5.08	2.7	0.4	1.2	6.0
FYD0H105ZF	5.5	1.0	1.6	35	1.5	4.2	21.5	16.0	7.62	3.0	0.6	1.2	11.0
FYD0H145ZF	5.5	1.4	2.1	45	2.1	4.2	21.5	19.0	7.62	3.0	0.6	1.2	12.0
FYD0H225ZF	5.5	2.2	3.3	35	3.3	4.2	28.5	22.0	10.16	6.1	0.6	1.4	22.9

FYH Type													
Part Number	MAX operating voltage (Vdc)	Nominal capacitance		MAX ESR (at 1 kHz) ( $\Omega$ )	MAX current at 30 min. (mA)	Voltage holding characteristics (V)	Dimension (unit:mm)						Weight (g)
		Charge system (F)	Discharge system (F)				$\phi D$	H	P	$\ell$	$d_1$	$d_2$	
FYH0H223ZF	5.5	0.022	0.033	200	0.033	4.2	11.5	7.0	5.08	2.7	0.4	1.2	1.5
FYH0H473ZF	5.5	0.047	0.075	100	0.071	4.2	13.0	7.0	5.08	2.2	0.4	1.2	2.2
FYH0H104ZF	5.5	0.10	0.16	50	0.15	4.2	16.5	7.5	5.08	2.7	0.4	1.2	3.4
FYH0H224ZF	5.5	0.22	0.30	60	0.33	4.2	16.5	9.5	5.08	2.7	0.4	1.2	3.6
FYH0H474ZF	5.5	0.47	0.70	35	0.71	4.2	21.5	10.0	7.62	3.0	0.6	1.2	7.2
FYH0H105ZF	5.5	1.0	1.5	20	1.5	4.2	28.5	11.0	10.16	6.1	0.6	1.4	13.9



- All specifications in this catalog and production status of products are subject to change without notice. Prior to the purchase, please contact TOKIN for updated product data.
- Please request for a specification sheet for detailed product data prior to the purchase.
- Before using the product in this catalog, please read "Precautions" and other safety precautions listed in the printed version catalog.

**Performance Characteristics**

Item	Series name	FY type	Test conditions (conforming to JIS C 5160-1)	
Category temperature range		-25°C to +70°C		
MAX operating voltage		5.5Vdc		
Capacitance		FYD : 0.022F to 2.2F FYH : 0.022F to 1.0F	Refer to "Measurement Conditions"	
Capacitance allowance		+80% , -20%	Refer to "Measurement Conditions"	
ESR		Refer to standard ratings	Measured at 1kHz, 10mA ; See also "Measurement Conditions"	
Current (30-minutes value)		Refer to standard ratings	Refer to "Measurement Conditions"	
Surge	Capacitance	More than 90% of initial specified value	Surge voltage : 6.3V Charge : 30 sec. Discharge : 9min 30sec. Number of cycles : 1000 Series resistance : 0.022F      560 Ω : 0.047F      300 Ω : 0.068F      240 Ω : 0.10F      150 Ω : 0.22F      56 Ω : 0.47F      30 Ω : 1.0F, 1.4F    15 Ω : 2.2F      10 Ω  Discharge resistance : 0 Ω Temperature : 70±2°C	
	ESR	Less than 120% of initial specified value		
	Current (30 minutes value)	Less than 120% of initial specified value		
Characteristics in different temperature	Capacitance	Phase 2	More than 50% of initial measured value	
			ESR	Less than 400% of initial measured value
	Capacitance	Phase 3	Conforms to 4.17 Phase1 : +25±2°C Phase2 : -25±2°C Phase4 : +25±2°C Phase5 : +70±2°C Phase6 : +25±2°C	
				ESR
	Capacitance	Phase 5		Less than 200% of initial measured value
	ESR			Satisfy initial specified value
	Current (30 minutes value)	1.5CV (mA) or below		
	Capacitance	Phase 6		Within ±20% of initial measured value
	ESR			Satisfy initial specified value
Current (30 minutes value)	Satisfy initial specified value			
Lead strength (tensile)		No terminal damage		Conforms to 4.9
Vibration resistance	Capacitance	Satisfy initial specified value	Conforms to 4.13 Frequency : 10 to 55 Hz Testing time : 6 hours	
	ESR			
	Current (30 minutes value)	No obvious abnormality		
	Appearance			
Solderability		Over 3/4 of the terminal should be covered by the new solder	Conforms to 4.11 Solder temp : 245±5°C Dipping time : 5±0.5 sec. 1.6mm from the bottom should be dipped.	
Solder heat resistance	Capacitance	Satisfy initial specified value	Conforms to 4.10 Solder temp : 260±10°C Dipping time : 10±1 sec. 1.6mm from the bottom should be dipped.	
	ESR			
	Current (30 minutes value)	No obvious abnormality		
	Appearance			
Temperature cycle	Capacitance	Satisfy initial specified value	Conforms to 4.12 Temperature condition : -25°C→ Room temperature → +70°C→ Room temperature Number of cycles : 5 Cycles	
	ESR			
	Current (30 minutes value)	No obvious abnormality		
	Appearance			
High temp. and high humidity resistance	Capacitance	Within ±20% of initial measured value	Conforms to 4.14 Temperature : 40±2°C Relative humidity : 90 to 95% RH Testing time : 240±8 hours	
	ESR	Less than 120% of initial specified value		
	Current (30 minutes value)	Less than 120% of initial specified value		
	Appearance	No obvious abnormality		
High temperature load	Capacitance	Within ±30% of initial measured value	Conforms to 4.15 Temperature : 70±2°C Voltage applied : MAX operating voltage Series protection resistance : 0 Ω Testing time : 1000 <sup>±8</sup> Hours	
	ESR	Less than 200% of initial specified value		
	Current (30 minutes value)	Less than 200% of initial specified value		
	Appearance	No obvious abnormality		
Self discharge characteristics (voltage holding characteristics)		Voltage between terminal leads higher than 4.2V	Charging condition	Voltage applied : 5.0Vdc (Terminal at the case's side be negative) Series resistance : 0 Ω Charging time : 24 hours
			Storage	Let stand for 24 hours in condition described below with terminals opened. Ambient temperature : Lower than 25°C Relative humidity : Lower than 70%RH



- All specifications in this catalog and production status of products are subject to change without notice. Prior to the purchase, please contact TOKIN for updated product data.
- Please request for a specification sheet for detailed product data prior to the purchase.
- Before using the product in this catalog, please read "Precautions" and other safety precautions listed in the printed version catalog.

**Typical Performance Data**

**Resistive discharge characteristics (Backup time capability) FYD Type**

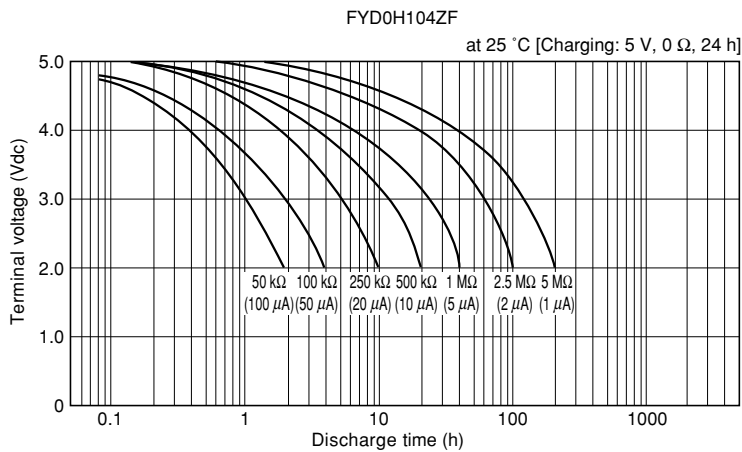
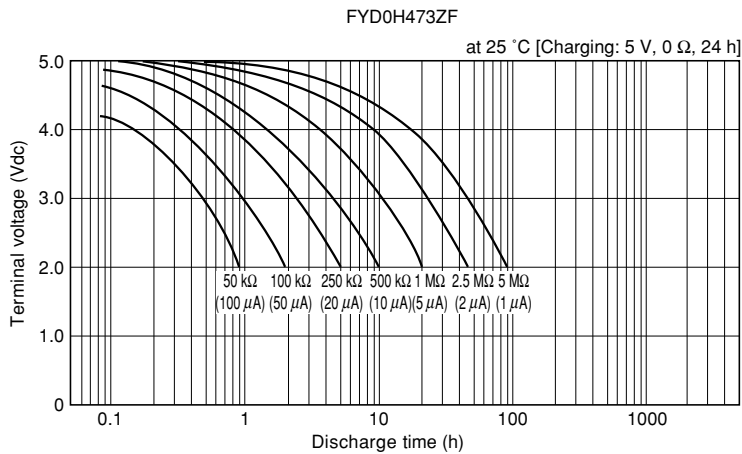
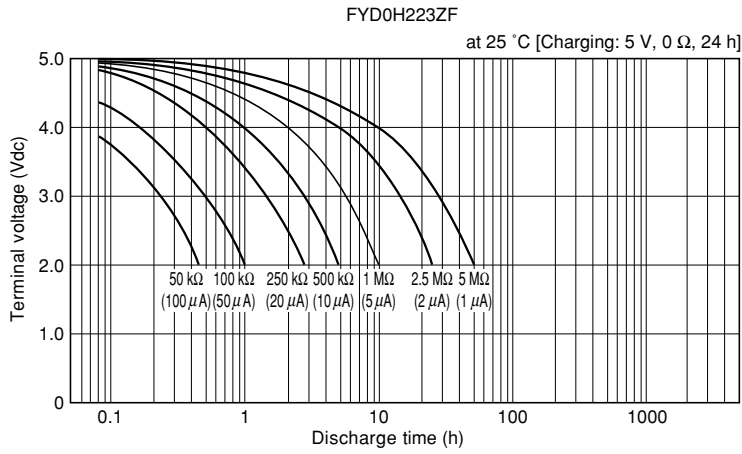

- All specifications in this catalog and production status of products are subject to change without notice. Prior to the purchase, please contact TOKIN for updated product data.
- Please request for a specification sheet for detailed product data prior to the purchase.
- Before using the product in this catalog, please read "Precautions" and other safety precautions listed in the printed version catalog.

**Resistive discharge characteristics (Backup time capability) FYD Type**

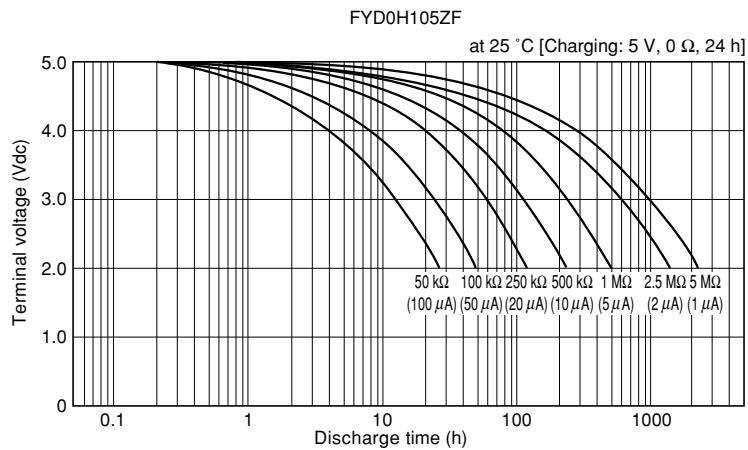
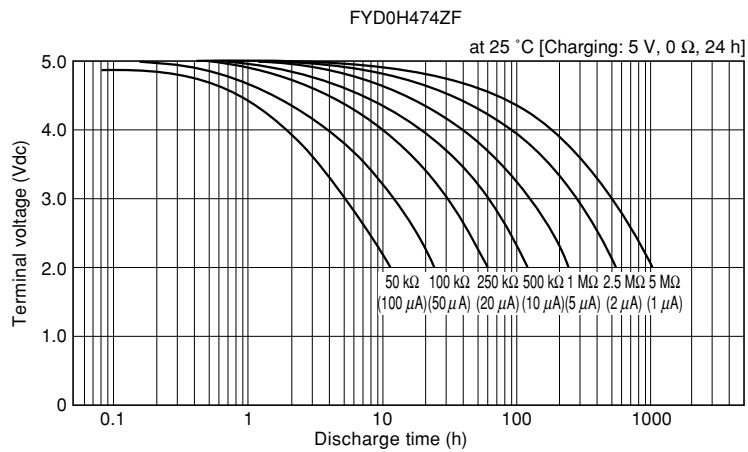
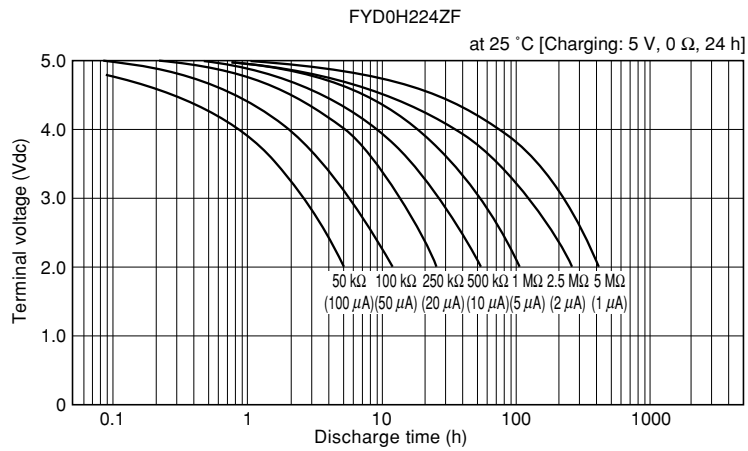

- All specifications in this catalog and production status of products are subject to change without notice. Prior to the purchase, please contact TOKIN for updated product data.
- Please request for a specification sheet for detailed product data prior to the purchase.
- Before using the product in this catalog, please read "Precautions" and other safety precautions listed in the printed version catalog.

Resistive discharge characteristics (Backup time capability) FYD Type

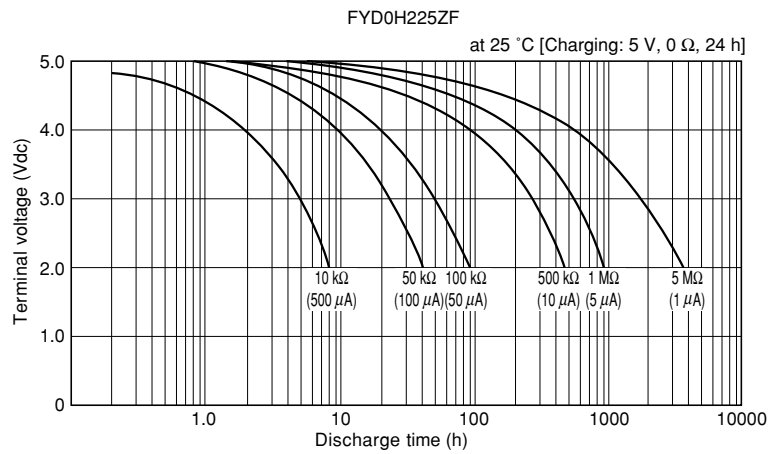
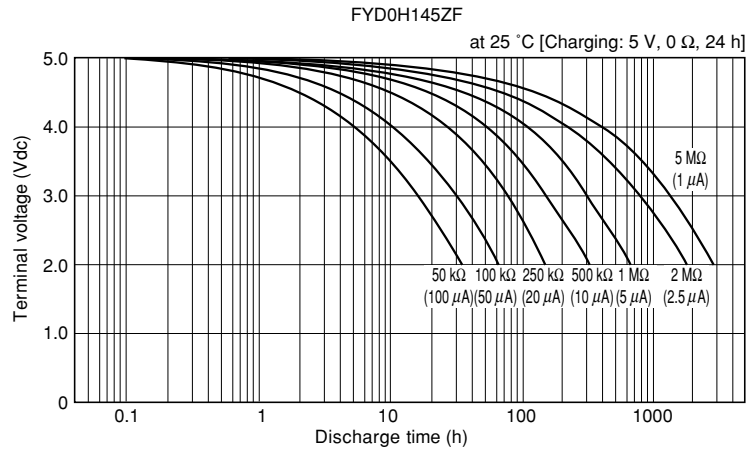

- All specifications in this catalog and production status of products are subject to change without notice. Prior to the purchase, please contact TOKIN for updated product data.
- Please request for a specification sheet for detailed product data prior to the purchase.
- Before using the product in this catalog, please read "Precautions" and other safety precautions listed in the printed version catalog.



**Resistive discharge characteristics (Backup time capability) FYH Type**

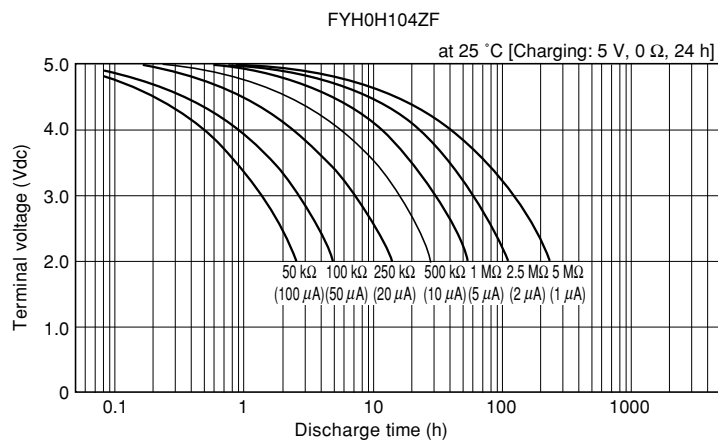
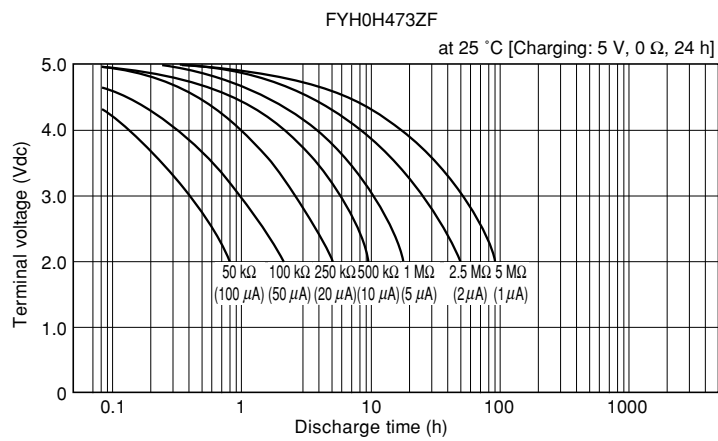
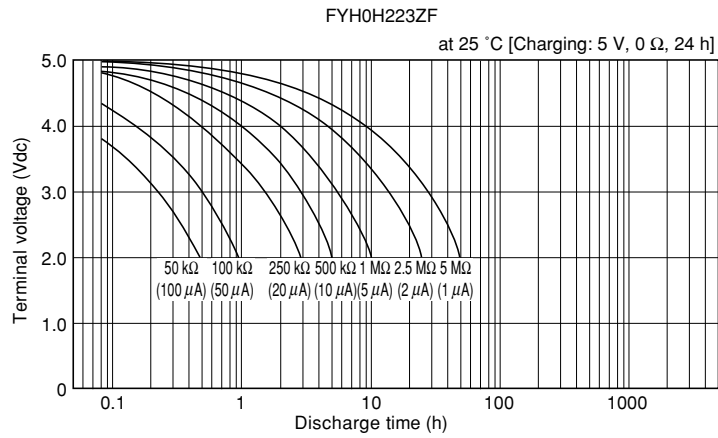

- All specifications in this catalog and production status of products are subject to change without notice. Prior to the purchase, please contact TOKIN for updated product data.
- Please request for a specification sheet for detailed product data prior to the purchase.
- Before using the product in this catalog, please read "Precautions" and other safety precautions listed in the printed version catalog.

**Resistive discharge characteristics (Backup time capability) FYH Type**

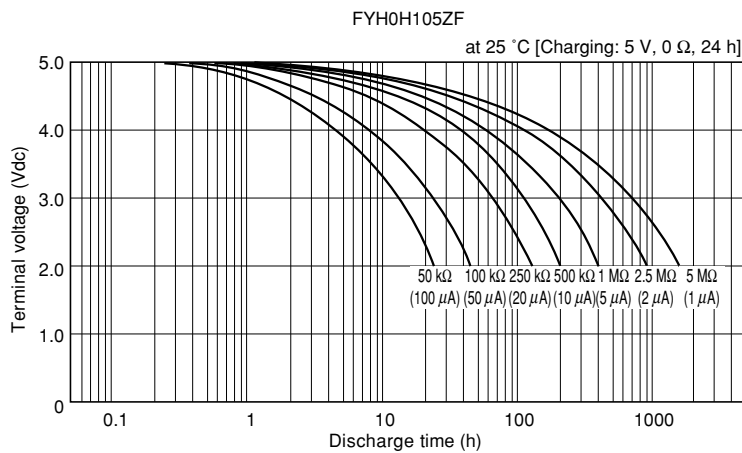
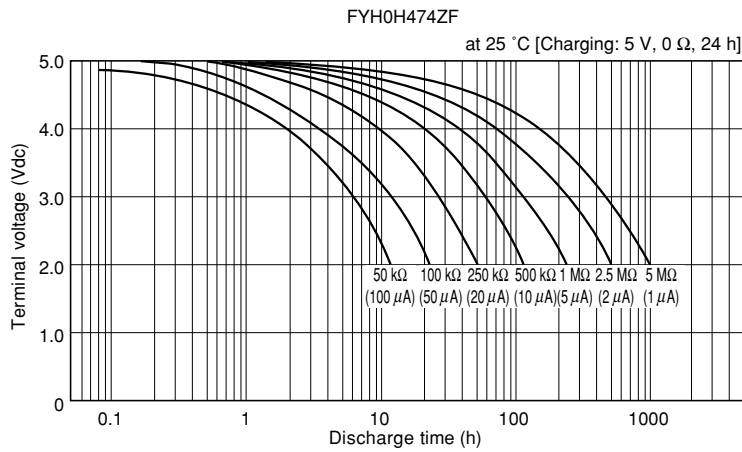
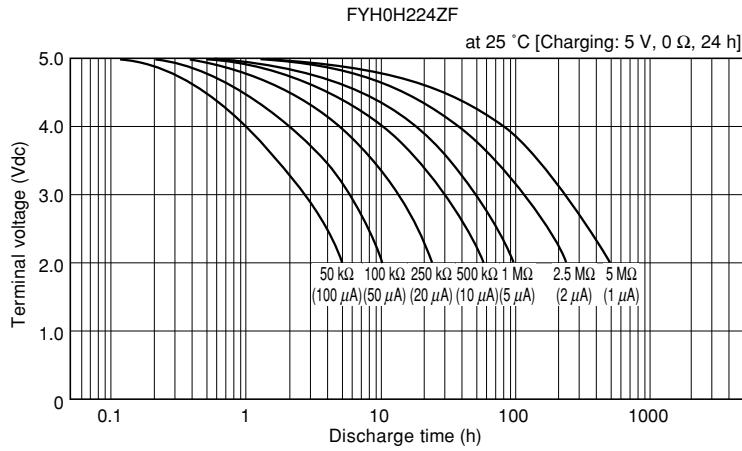

- All specifications in this catalog and production status of products are subject to change without notice. Prior to the purchase, please contact TOKIN for updated product data.
- Please request for a specification sheet for detailed product data prior to the purchase.
- Before using the product in this catalog, please read "Precautions" and other safety precautions listed in the printed version catalog.

# 15

## FR-SERIES SuperCapacitor

(Wide Operating Temperature Range) (For cleanable products, see page 28.)

The FR Series SuperCapacitors are small-sized electric double-layer capacitors that can operate in a temperature range as wide as  $-40^{\circ}\text{C}$  to  $+85^{\circ}\text{C}$ .

These capacitors are ideal as long-time backup devices for minute current loads in industrial equipment such as measuring instruments, control equipment, and communications equipment.

### Features

- Wide operating temperature range ( $-40^{\circ}\text{C}$  to  $+85^{\circ}\text{C}$ )
- High reliability (Load life of  $85^{\circ}\text{C}$ ,  $5.5\text{ V}$  : 1000 H guaranteed)
- Excellent voltage holding characteristics ideal for long-time current supply of  $1\ \mu\text{A}$  to several hundred  $\mu\text{A}$
- Wide capacitance range (0.022 F to 1.0 F)

- No drawbacks of overcharge and overdischarge. No protection circuit required. Quick charge and discharge.
- The capacitors can satisfactorily function during the design life of a set and no maintenance is required, provided the capacitors are used under the prescribed conditions.
- Flow-solderable. Superior mountability.
- Environmentally-friendly end-product design can be achieved using these capacitors free from heavy metals such as cadmium.
- Lead-free, PVC-free type. RoHS Compliant.

### Applications

Memory back-up for C-MOS microcomputers, static RAMs, DTSs (Digital tuning systems) and so forth.

### Part Number System

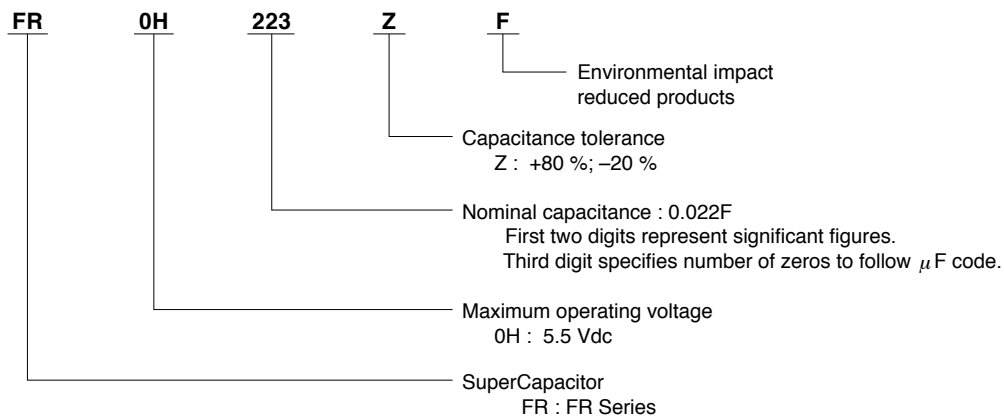

### Markings

Name of manufacturer, maximum operating voltage, capacitance, manufacture date code, serial no., and series name are marked on the external tube. The negative lead terminal is marked with black bands.

Conversion table for manufacture date code

Year	'2010	'11	'12	'13	'14	'15	'16	'17	'18	'19	'20	'21
Indication	A	B	C	D	E	F	H	J	K	L	M	N
Month	1	2	3	4	5	6	7	8	9	10	11	12
Indication	1	2	3	4	5	6	7	8	9	O	N	D

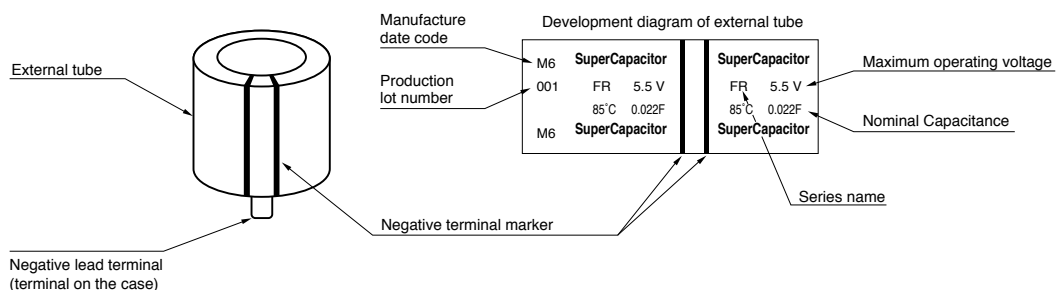

- All specifications in this catalog and production status of products are subject to change without notice. Prior to the purchase, please contact TOKIN for updated product data.
- Please request for a specification sheet for detailed product data prior to the purchase.
- Before using the product in this catalog, please read "Precautions" and other safety precautions listed in the printed version catalog.

**Dimensions**

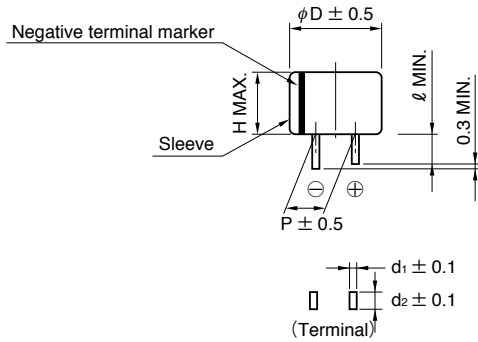

**Standard Ratings**

Part Number	MAX operating voltage (Vdc)	Nominal capacitance		MAX ESR (at 1 kHz) ( $\Omega$ )	MAX current at 30 min. (mA)	Voltage holding characteristics (V)	Dimension (unit:mm)						Weight (g)
		Charge system (F)	Discharge system (F)				$\phi D$	H	P	$l$	$d_1$	$d_2$	
FR0H223ZF	5.5	0.022	0.028	220	0.033	4.2	11.5	14.0	5.08	2.7	0.4	1.2	2.3
FR0H473ZF	5.5	0.047	0.060	110	0.071	4.2	14.5	14.0	5.08	2.4	0.4	1.2	3.9
FR0H104ZF	5.5	0.10	0.15	150	0.15	4.2	14.5	15.5	5.08	2.4	0.4	1.2	4.3
FR0H224ZF	5.5	0.22	0.33	180	0.33	4.2	14.5	21.0	5.08	2.4	0.4	1.2	5.3
FR0H474ZF	5.5	0.47	0.75	100	0.71	4.2	16.5	21.5	5.08	2.7	0.4	1.2	7.5
FR0H105ZF	5.5	1.0	1.6	60	1.5	4.2	21.5	22.0	7.62	3.0	0.6	1.2	13.3



- All specifications in this catalog and production status of products are subject to change without notice. Prior to the purchase, please contact TOKIN for updated product data.
- Please request for a specification sheet for detailed product data prior to the purchase.
- Before using the product in this catalog, please read "Precautions" and other safety precautions listed in the printed version catalog.

**Performance Characteristics**

Item	Series name	FR type		Test conditions (conforming to JIS C 5160-1)
Category temperature range		-40°C to +85°C		
MAX operating voltage		5.5Vdc		
Capacitance		0.022F to 1.0F		Refer to "Measurement Conditions"
Capacitance allowance		+80%, -20%		Refer to "Measurement Conditions"
ESR		Refer to standard ratings		Measured at 1kHz, 10mA ; See also "Measurement Conditions"
Current (30-minutes value)		Refer to standard ratings		Refer to "Measurement Conditions"
Surge	Capacitance	More than 90% of initial specified value		Surge voltage : 6.3V (5.5V type) Charge : 30 sec. Discharge : 9min 30sec. Number of cycles : 1000 Series resistance : 0.022F      560 Ω : 0.047F                          300 Ω : 0.068F                          240 Ω : 0.10F                              150 Ω : 0.22F                              56 Ω : 0.47F                              30 Ω : 1.0F                                15 Ω  Discharge resistance : 0 Ω Temperature : 85±2°C
	ESR	Less than 120% of initial specified value		
	Current (30 minutes value)	Less than 120% of initial specified value		
	Appearance	No obvious abnormality		
Characteristics in different temperature	Capacitance	Phase 2	More than 50% of initial measured value	Conforms to 4.17 Phase1 : +25±2°C Phase2 : -25±2°C Phase3 : -40±2°C Phase4 : +25±2°C Phase5 : +85±2°C Phase6 : +25±2°C
	ESR		Less than 400% of initial measured value	
	Capacitance	Phase 3	More than 30% of initial measured value	
	ESR		Less than 700% of initial measured value	
	Capacitance	Phase 5	Less than 200% of initial measured value	
	ESR		Satisfy initial specified value	
	Current (30 minutes value)		1.5CV (mA) or below	
	Capacitance	Phase 6	Within ±20% of initial measured value	
	ESR		Satisfy initial specified value	
Current (30 minutes value)	Satisfy initial specified value			
Lead strength (tensile)		No terminal damage		Conforms to 4.9
Vibration resistance	Capacitance	Satisfy initial specified value		Conforms to 4.13 Frequency : 10 to 55 Hz Testing time : 6 hours
	ESR			
	Current (30 minutes value)	No obvious abnormality		
	Appearance			
Solderability		Over 3/4 of the terminal should be covered by the new solder		Conforms to 4.11 Solder temp : 245±5°C Dipping time : 5±0.5 sec. 1.6mm from the bottom should be dipped.
Solder heat resistance	Capacitance	Satisfy initial specified value		Conforms to 4.10 Solder temp : 260±10°C Dipping time : 10±1 sec. 1.6mm from the bottom should be dipped.
	ESR			
	Current (30 minutes value)	No obvious abnormality		
	Appearance			
Temperature cycle	Capacitance	Satisfy initial specified value		Conforms to 4.12 Temperature condition : -40°C → Room temperature → +85°C → Room temperature Number of cycles : 5 Cycles
	ESR			
	Current (30 minutes value)	No obvious abnormality		
	Appearance			
High temp. and high humidity resistance	Capacitance	Within ±20% of initial measured value		Conforms to 4.14 Temperature : 40±2°C Relative humidity : 90 to 95% RH Testing time : 240±8 hours
	ESR	Less than 120% of initial specified value		
	Current (30 minutes value)	Less than 120% of initial specified value		
	Appearance	No obvious abnormality		
High temperature load	Capacitance	Within ±30% of initial measured value		Conforms to 4.15 Temperature : 85±2°C Voltage applied : MAX operating voltage Series protection resistance : 0 Ω Testing time : 1000 ±8 Hours
	ESR	Less than 200% of initial specified value		
	Current (30 minutes value)	Less than 200% of initial specified value		
	Appearance	No obvious abnormality		
Self discharge characteristics (voltage holding characteristics)	Voltage between terminal leads higher than 4.2V		Charging condition	Voltage applied : 5.0Vdc (Terminal at the case's side be negative) Series resistance : 0 Ω Charging time : 24 hours
			Storage	Let stand for 24 hours in condition described below with terminals opened. Ambient temperature : Lower than 25°C Relative humidity : Lower than 70%RH



- All specifications in this catalog and production status of products are subject to change without notice. Prior to the purchase, please contact TOKIN for updated product data.
- Please request for a specification sheet for detailed product data prior to the purchase.
- Before using the product in this catalog, please read "Precautions" and other safety precautions listed in the printed version catalog.

**Typical Performance Data**

**Resistive discharge characteristics (Backup time capability)**

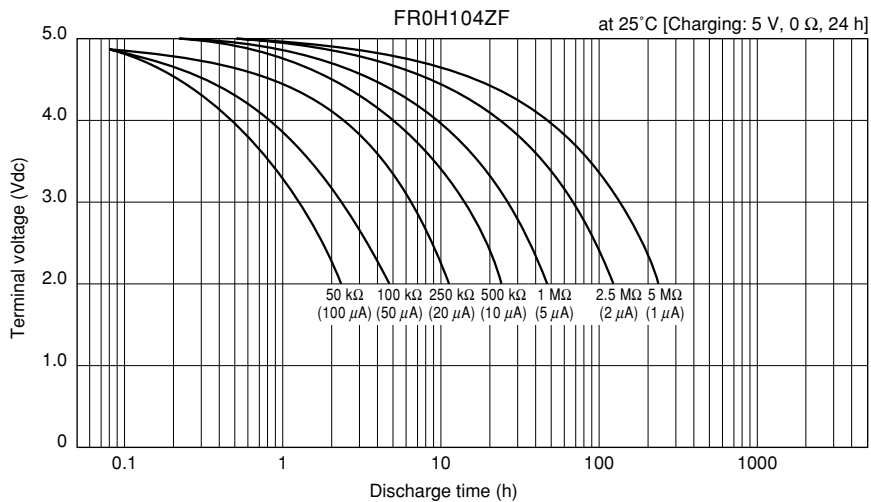
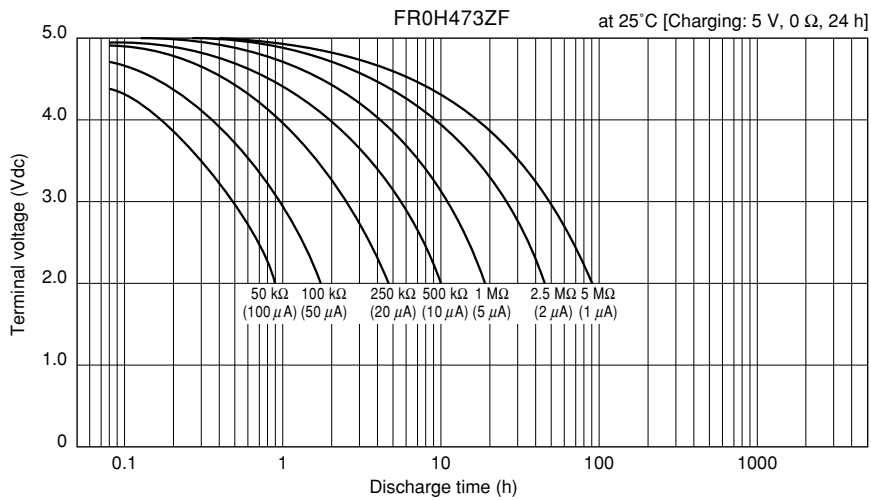
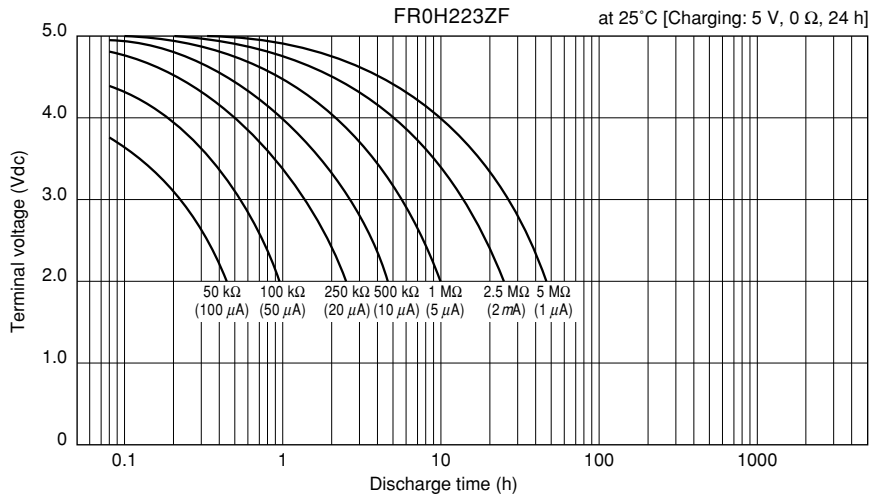

- All specifications in this catalog and production status of products are subject to change without notice. Prior to the purchase, please contact TOKIN for updated product data.
- Please request for a specification sheet for detailed product data prior to the purchase.
- Before using the product in this catalog, please read "Precautions" and other safety precautions listed in the printed version catalog.

**Resistive discharge characteristics (Backup time capability)**

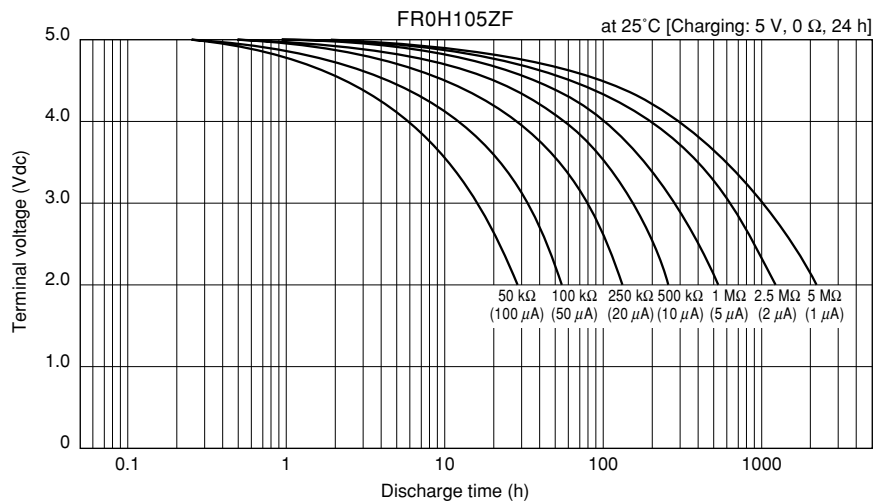
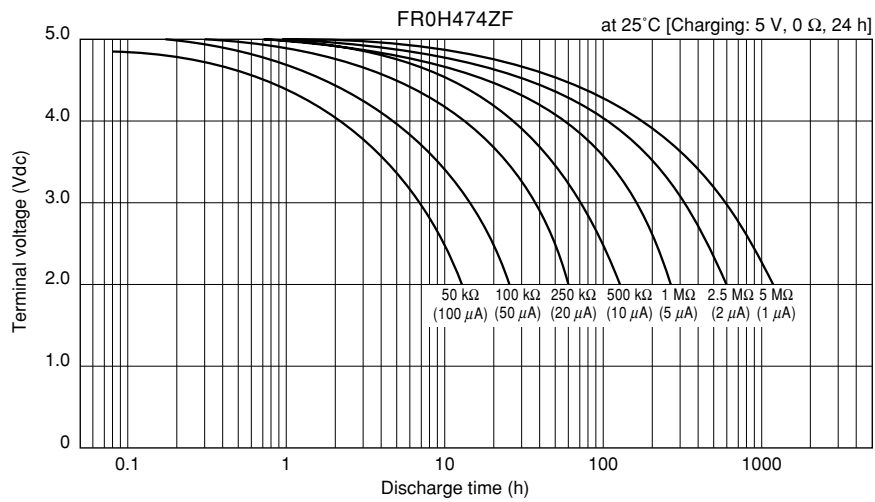
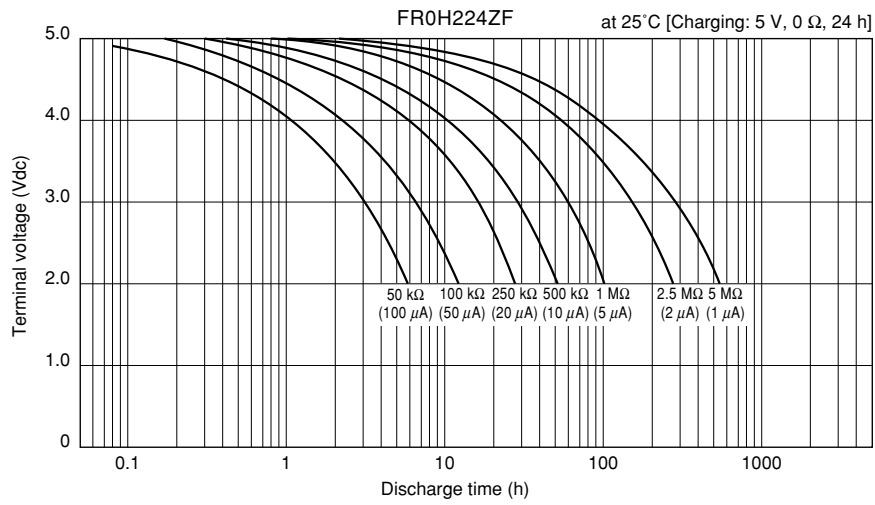

- All specifications in this catalog and production status of products are subject to change without notice. Prior to the purchase, please contact TOKIN for updated product data.
- Please request for a specification sheet for detailed product data prior to the purchase.
- Before using the product in this catalog, please read "Precautions" and other safety precautions listed in the printed version catalog.



## FS-SERIES SuperCapacitor

(Miniaturized, Large Capacitance) (For cleanable products, see page 28.)

The miniaturized FS-Series SuperCapacitors with large capacitance are backup devices adaptable to current consumption levels ranging from several hundred  $\mu\text{A}$  to several hundred mA. Choices can be made between 2 levels of maximum operating voltage to best correspond to backup operations: 5.5 V. DC (0.022 to 1.0 F), 11 V. DC (0.47 F and 1.0 F only) and 12 V. DC (1.0 F and 5.0 F only).

### Features

#### [Comparison with batteries]

- Environmentally-friendly end-product design can be achieved using these capacitors free from heavy metals such as cadmium.
- Wide operating range:  $-25$  to  $+70^\circ\text{C}$ .
- No drawbacks of overcharge and overdischarge. No protection circuit required. Quick charge and discharge.
- Full life duration that matches that of end-products if used properly.
- Flow-solderable. Superior mountability.
- Lead-free, PVC-free type. RoHS Compliant.

#### [Characteristics of FS-Series]

- The volume of the products is approx. 1/3 that of the FA-/FE-Series products.
- The ESR is approx. 1/3 that of FY-/FM-Series. Adaptable to current consumption levels ranging from several hundred  $\mu\text{A}$  to several hundred mA.

### Applications

- Memory backup for microcomputers, SRAMs, DRAMs, and system boards in the event of a momentary power failure.
- Auxiliary power source for mechanical devices (motors, relays, solenoid valves, actuators, buzzers, and so on).

### Part Number System

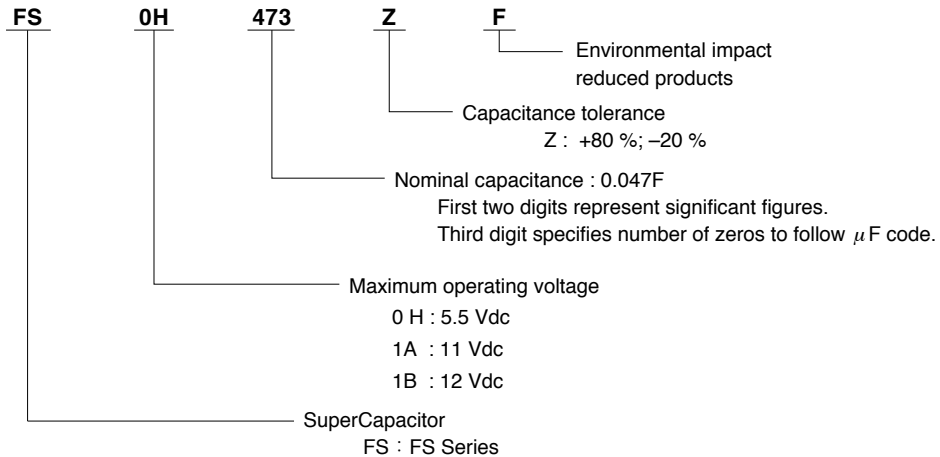

- All specifications in this catalog and production status of products are subject to change without notice. Prior to the purchase, please contact TOKIN for updated product data.
- Please request for a specification sheet for detailed product data prior to the purchase.
- Before using the product in this catalog, please read "Precautions" and other safety precautions listed in the printed version catalog.



**Markings**

Name of manufacturer, maximum operating voltage, capacitance, manufacture date code, serial no., and series name are marked on the external tube. The negative lead terminal is marked with black bands.

**Conversion table for manufacture date code**

Year	2010	'11	'12	'13	'14	'15	'16	'17	'18	'19	'20	'21
Indication	A	B	C	D	E	F	H	J	K	L	M	N
Month	1	2	3	4	5	6	7	8	9	10	11	12
Indication	1	2	3	4	5	6	7	8	9	O	N	D

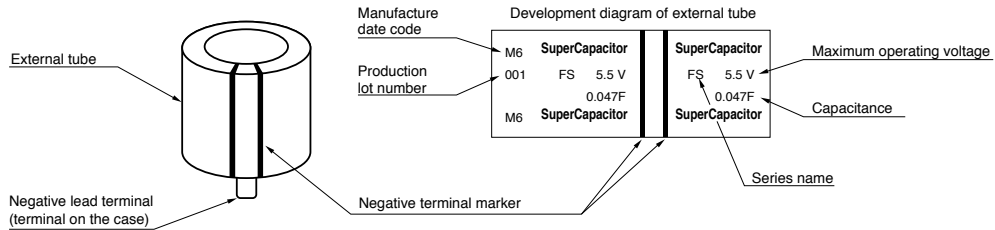

**Dimensions**

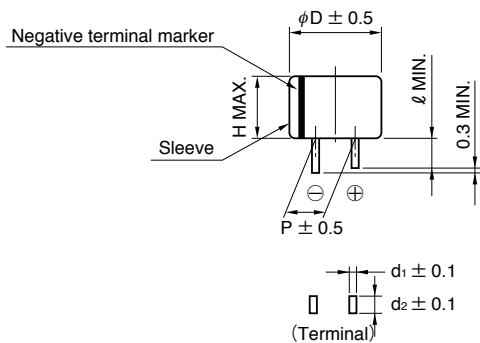

**Standard Ratings**

Part Number	MAX operating voltage (Vdc)	Nominal capacitance		MAX ESR (at 1 kHz) ( $\Omega$ )	MAX current at 30 min. (mA)	Dimension (unit:mm)						Weight (g)
		Charge system (F)	Discharge system (F)			$\phi D$	H	P	$\ell$	$d_1$	$d_2$	
FS0H223ZF	5.5	0.022	0.033	60.0	0.033	11.5	8.5	5.08	2.7	0.4	1.2	1.6
FS0H473ZF	5.5	0.047	0.072	40.0	0.071	13.0	8.5	5.08	2.2	0.4	1.2	2.6
FS0H104ZF	5.5	0.10	0.15	25.0	0.15	16.5	8.5	5.08	2.7	0.4	1.2	4.1
FS0H224ZF	5.5	0.22	0.33	25.0	0.33	16.5	13.0	5.08	2.7	0.4	1.2	5.3
FS0H474ZF	5.5	0.47	0.75	13.0	0.71	21.5	13.0	7.62	3.0	0.6	1.2	10
FS0H105ZF	5.5	1.0	1.3	7.0	1.5	28.5	14.0	10.16	6.1	0.6	1.4	18
FS1A474ZF	11.0	0.47	0.60	7.0	1.41	28.5	25.5	10.16	6.1	0.6	1.4	32
FS1A105ZF	11.0	1.0	1.3	7.0	3.0	28.5	31.5	10.16	6.1	0.6	1.4	35
FS1B105ZF	12.0	1.0	1.3	7.5	3.6	28.5	38.0	10.16	6.1	0.6	1.4	40
FS1B505ZF	12.0	5.0	6.5	4.0	18.0	44.8	60.0	20.00	9.5	1.0	1.4	160



- All specifications in this catalog and production status of products are subject to change without notice. Prior to the purchase, please contact TOKIN for updated product data.
- Please request for a specification sheet for detailed product data prior to the purchase.
- Before using the product in this catalog, please read "Precautions" and other safety precautions listed in the printed version catalog.

**Performance Characteristics**

Item	Series name	FS type		Test conditions (conforming to JIS C 5160-1)
Category temperature range		-25°C to +70°C		
MAX operating voltage		5.5Vdc, 11Vdc, 12Vdc		
Capacitance		5.5V : 0.022F to 1.0F 11V : 0.47, 1.0 12V : 1.0F, 5.0F		Refer to "Measurement Conditions"
Capacitance allowance		+80% , -20%		Refer to "Measurement Conditions"
ESR		Refer to standard ratings		Measured at 1kHz, 10mA ; See also "Measurement Conditions"
Current (30-minutes value)		Refer to standard ratings		Refer to "Measurement Conditions"
Surge	Capacitance	More than 90% of initial specified value		Surge voltage : 6.3V (5.5V type) : 12.6V (11V type) : 13.6V (12V type)  Charge : 30 sec. Discharge : 9min 30sec. Number of cycles : 1000 Series resistance : 0.022F      560Ω : 0.047F                      300Ω : 0.10F                         150Ω : 0.22F                         56Ω : 0.47F                         30Ω : 1.0F                          15Ω : 5.0F                          10Ω  Discharge resistance : 0Ω Temperature : 70±2°C
	ESR	Less than 120% of initial specified value		
	Current (30 minutes value)	Less than 120% of initial specified value		
	Appearance	No obvious abnormality		
Characteristics in different temperature	Capacitance	Phase 2	More than 50% of initial measured value	Conforms to 4.17 Phase1 : +25±2°C Phase2 : -25±2°C Phase4 : +25±2°C Phase5 : +70±2°C Phase6 : +25±2°C
	ESR		Less than 300% of initial measured value	
	Capacitance	Phase 3		
	ESR			
	Capacitance	Phase 5	Less than 150% of initial measured value	
	ESR		Satisfy initial specified value	
	Current (30 minutes value)		1.5CV (mA) or below	
	Capacitance	Phase 6	Within ±20% of initial measured value	
	ESR		Satisfy initial specified value	
Current (30 minutes value)	Satisfy initial specified value			
Lead strength (tensile)		No terminal damage		Conforms to 4.9
Vibration resistance	Capacitance	Satisfy initial specified value		Conforms to 4.13 Frequency : 10 to 55 Hz Testing time : 6 hours
	ESR			
	Current (30 minutes value)			
	Appearance			
Solderability		Over 3/4 of the terminal should be covered by the new solder		Conforms to 4.11 Solder temp : 245±5°C Dipping time : 5±0.5 sec. 1.6mm from the bottom should be dipped.
Solder heat resistance	Capacitance	Satisfy initial specified value		Conforms to 4.10 Solder temp : 260±10°C Dipping time : 10±1 sec. 1.6mm from the bottom should be dipped.
	ESR			
	Current (30 minutes value)			
	Appearance			
Temperature cycle	Capacitance	Satisfy initial specified value		Conforms to 4.12 Temperature condition : -25°C→ Room temperature → +70°C→ Room temperature Number of cycles : 5 Cycles
	ESR			
	Current (30 minutes value)			
	Appearance			
High temp. and high humidity resistance	Capacitance	More than 90% of initial specified value (5.5V type) Within ±20% of initial measured value (11V type, 12V type)		Conforms to 4.14 Temperature : 40±2°C Relative humidity : 90 to 95% RH Testing time : 240±8 hours
	ESR	Less than 120% of initial specified value		
	Current (30 minutes value)	Less than 120% of initial specified value		
	Appearance	No obvious abnormality		
High temperature load	Capacitance	More than 85% of initial specified value (5.5V type) Within ±30% of initial measured value (11V type, 12V type)		Conforms to 4.15 Temperature : 70±2°C Voltage applied : MAX operating voltage Series protection resistance : 0Ω Testing time : 1000 <sup>±8</sup> Hours
	ESR	Less than 200% of initial specified value		
	Current (30 minutes value)	Less than 200% of initial specified value		
	Appearance	No obvious abnormality		



- All specifications in this catalog and production status of products are subject to change without notice. Prior to the purchase, please contact TOKIN for updated product data.
- Please request for a specification sheet for detailed product data prior to the purchase.
- Before using the product in this catalog, please read "Precautions" and other safety precautions listed in the printed version catalog.

**Typical Performance Data**

**Resistive discharge characteristics (Backup time capability)**

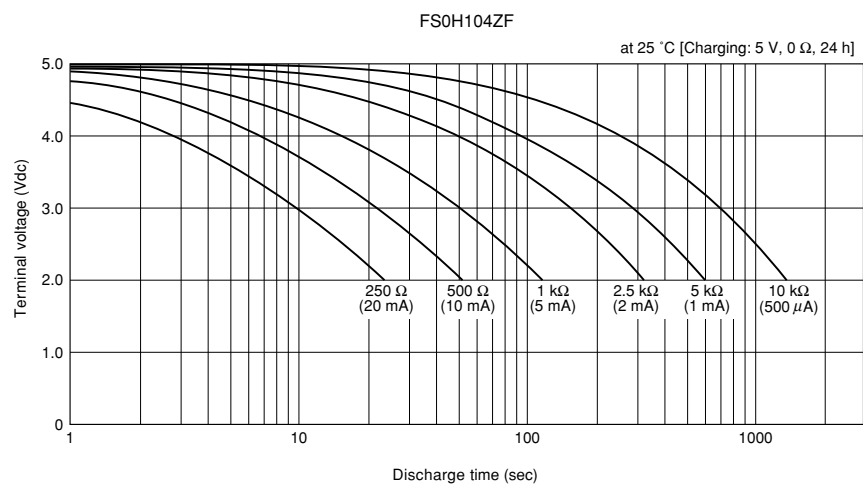
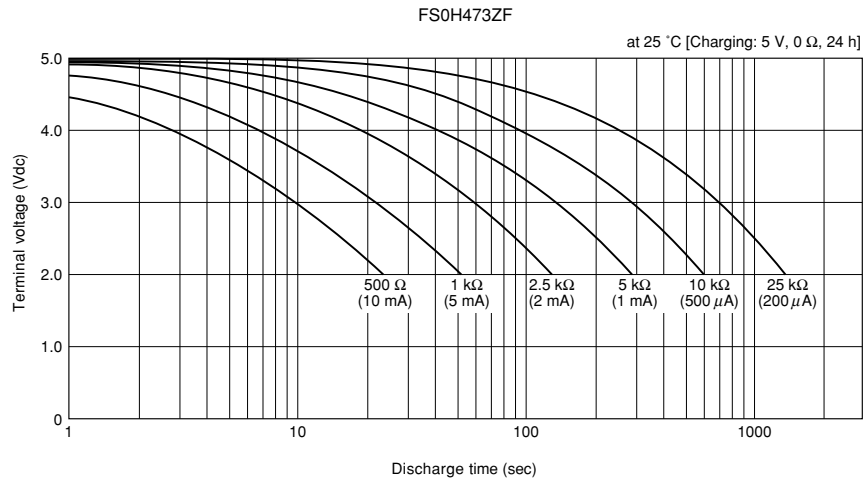
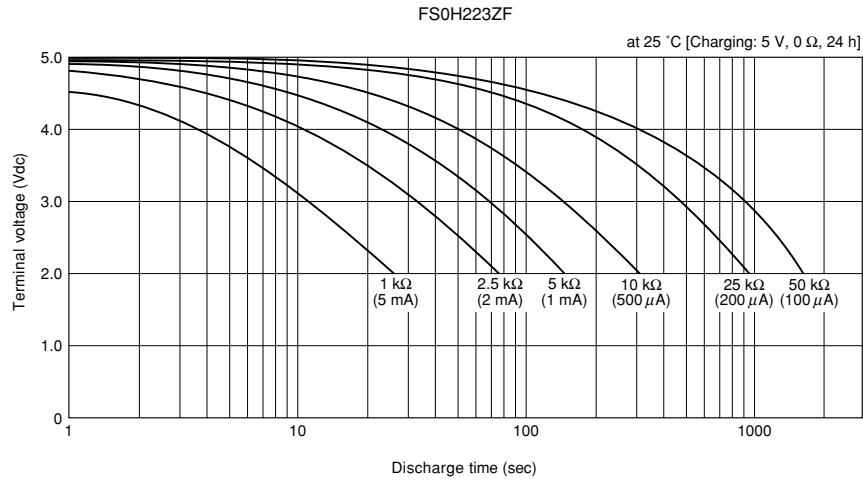

- All specifications in this catalog and production status of products are subject to change without notice. Prior to the purchase, please contact TOKIN for updated product data.
- Please request for a specification sheet for detailed product data prior to the purchase.
- Before using the product in this catalog, please read "Precautions" and other safety precautions listed in the printed version catalog.

**Resistive discharge characteristics (Backup time capability)**

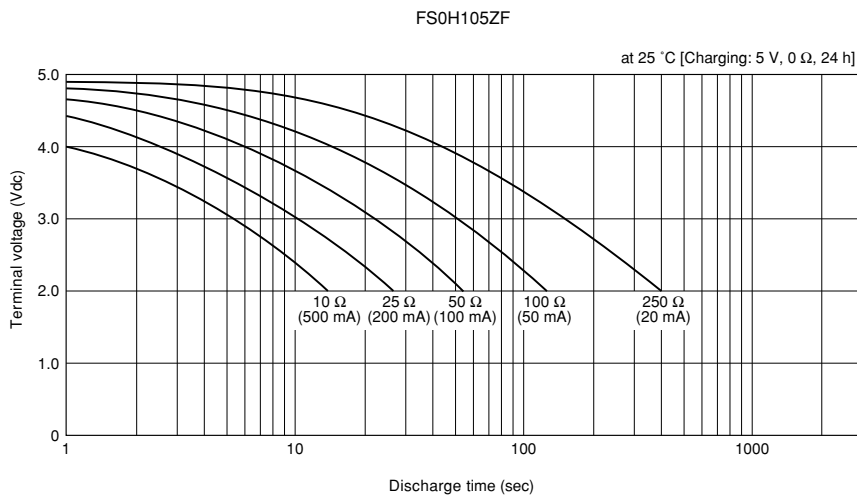
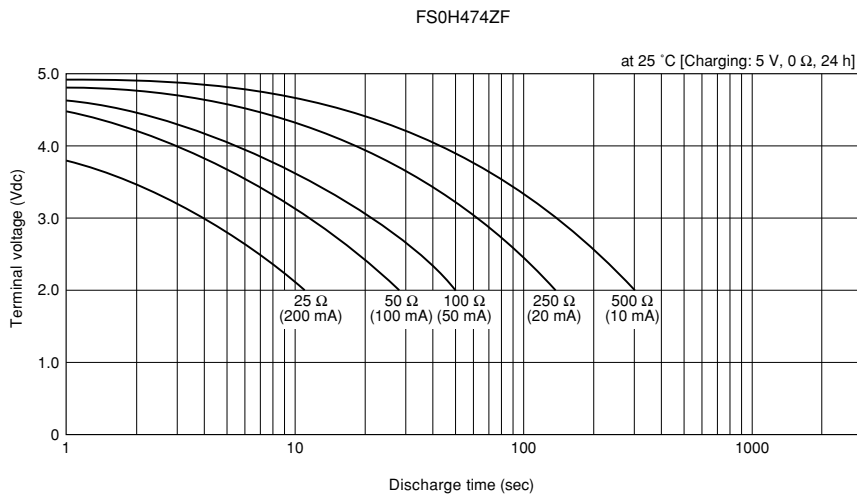
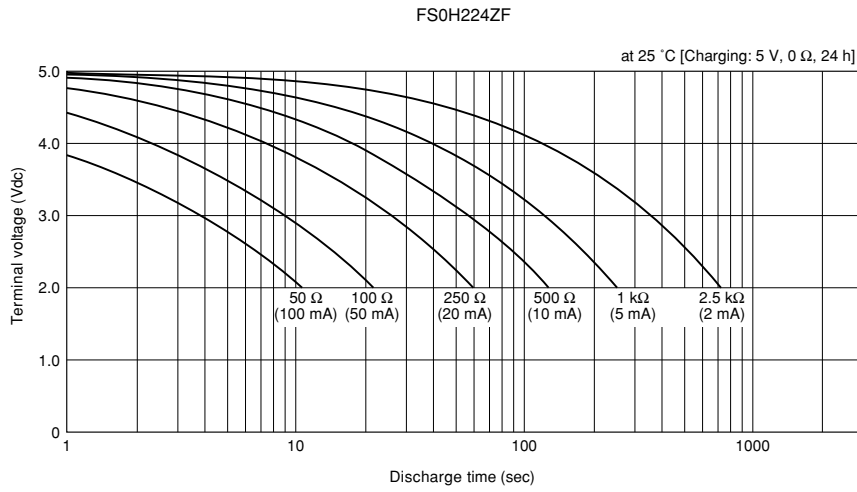

- All specifications in this catalog and production status of products are subject to change without notice. Prior to the purchase, please contact TOKIN for updated product data.
- Please request for a specification sheet for detailed product data prior to the purchase.
- Before using the product in this catalog, please read "Precautions" and other safety precautions listed in the printed version catalog.

**Resistive discharge characteristics (Backup time capability)**

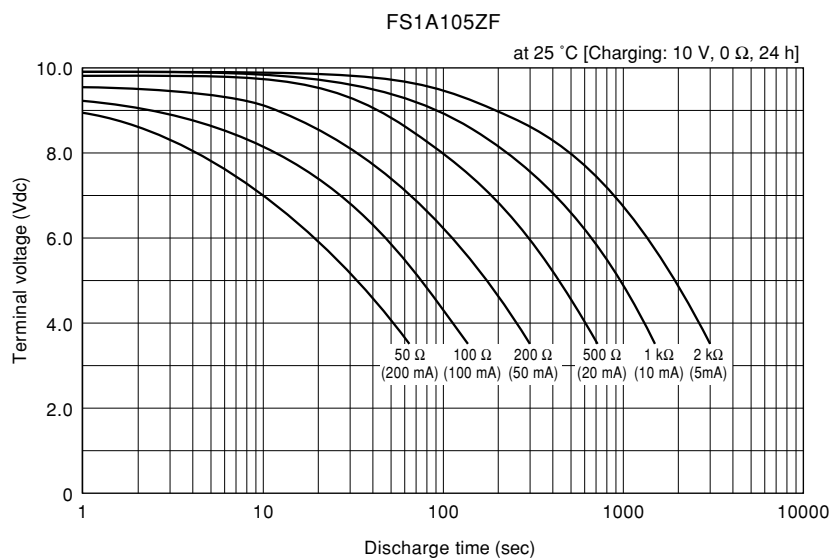
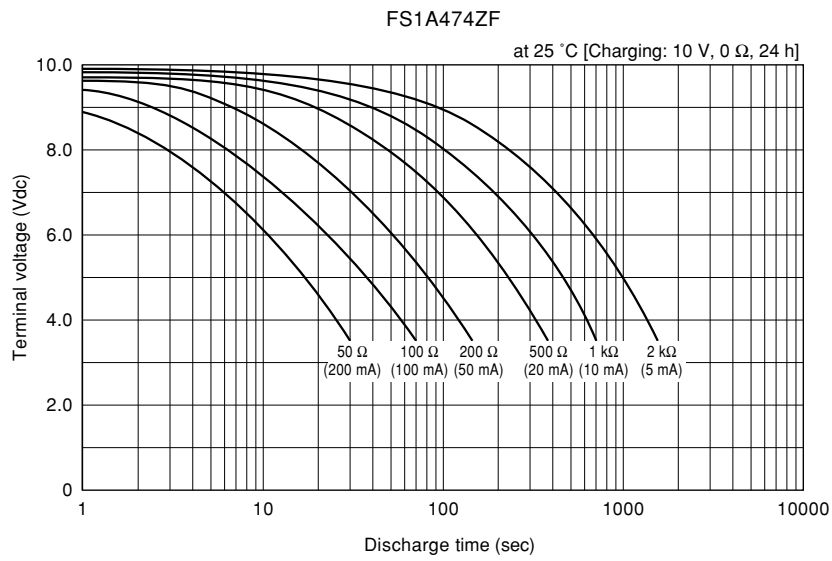

- All specifications in this catalog and production status of products are subject to change without notice. Prior to the purchase, please contact TOKIN for updated product data.
- Please request for a specification sheet for detailed product data prior to the purchase.
- Before using the product in this catalog, please read "Precautions" and other safety precautions listed in the printed version catalog.

**Resistive discharge characteristics (Backup time capability)**

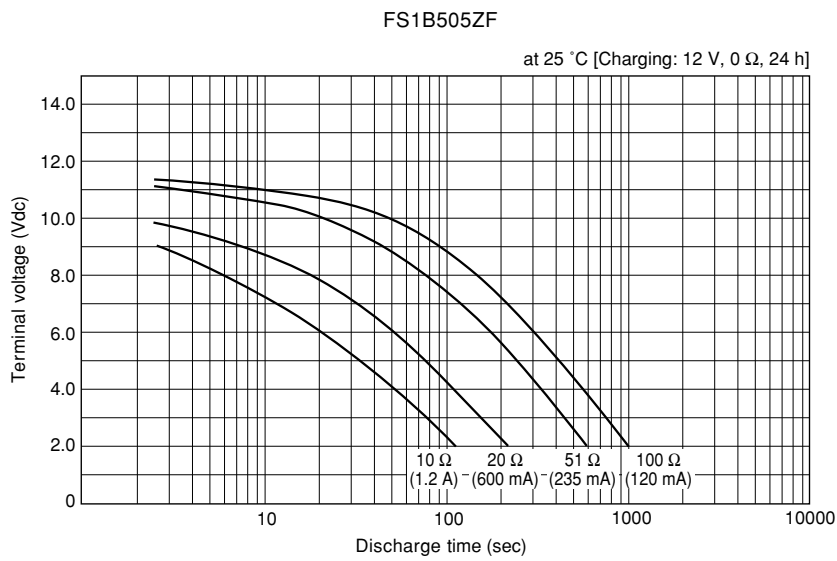
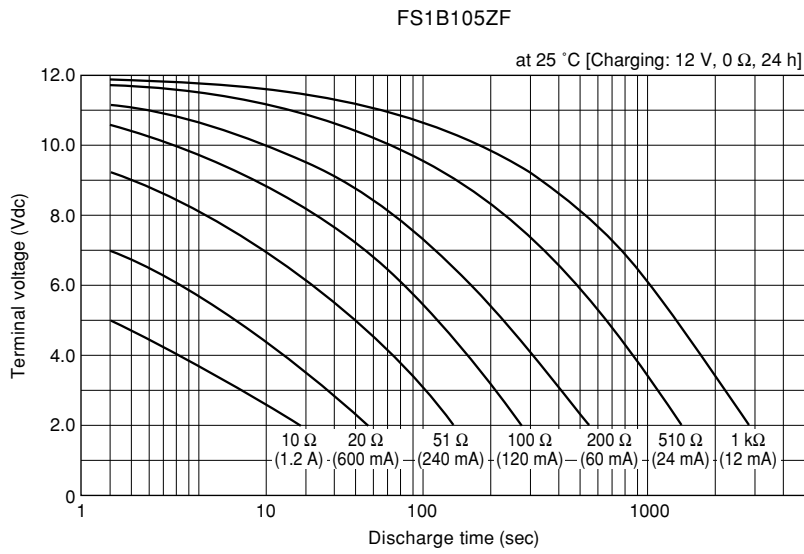

- All specifications in this catalog and production status of products are subject to change without notice. Prior to the purchase, please contact TOKIN for updated product data.
- Please request for a specification sheet for detailed product data prior to the purchase.
- Before using the product in this catalog, please read "Precautions" and other safety precautions listed in the printed version catalog.



## FA-SERIES/FE-SERIES SuperCapacitor

(For Heavy Current) (For cleanable products, see page 28.)

The miniaturized FA-Series/FE-Series SuperCapacitors with large capacitance and low internal resistance (Equivalent Series Resistance) are capable of carrying out charges and discharges ranging in the order of milliamperes to amperes.

These products offer excellent performance in instantaneous backup (countermeasure against momentary power failure) of electric load of the same range in electronic devices.

### Features

#### [Comparison with batteries]

- Environmentally-friendly end-product design can be achieved using these capacitors free from heavy metals such as cadmium.
- Wide operating range: -25 to +70°C (-40 to +70°C for FE-Series).
- No drawbacks of overcharge and overdischarge. No protection circuit or limiting circuit required. Quick charge and discharge.
- Full life duration that matches that of end-products if used properly.
- Flow-solderable. Superior mountability.
- Lead-free, PVC-free type. RoHS Compliant.

#### [Characteristics of FA-/FE-Series]

- Electric double-layer capacitors capable of carrying out charges and discharges ranging in the order of milliamperes to amperes with an ESR (Equivalent Series Resistance) approx. 1/4 that of the FS-Series and approx. 1/10 that of FY-/FM-Series.

#### [Differences between FA-Series and FE-Series]

- The FE-Series products have lower ESR specifications than those of FA-Series featuring equivalent capacitance. And as for dimensions, the FE-Series products are one size smaller than the FA-Series. Due to the differences in guaranteed performance and lead terminal pitches, however, the customer is requested to choose the proper series for each end-product.
- The FA-Series offers a model which guarantees a maximum operating voltage of 11V. (5.5V maximum for the FE-Series.)

### Applications

- Memory backup for microcomputers, SRAMs, DRAMs, and system boards in the event of a momentary power failure.
- Auxiliary power source for mechanical devices (motors, relays, solenoid valves, actuators, buzzers, and so on).

### Part Number System

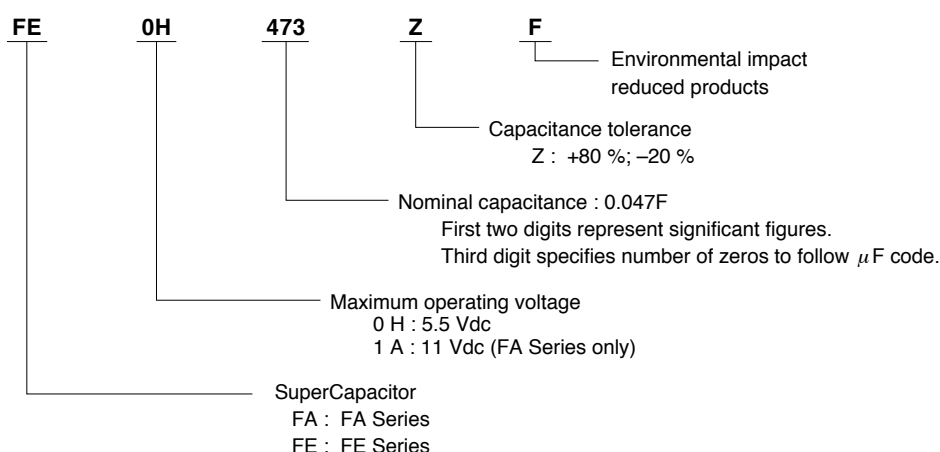

- All specifications in this catalog and production status of products are subject to change without notice. Prior to the purchase, please contact TOKIN for updated product data.
- Please request for a specification sheet for detailed product data prior to the purchase.
- Before using the product in this catalog, please read "Precautions" and other safety precautions listed in the printed version catalog.

**FA Series**

**Marking**

Name of manufacturer, rated voltage, capacitance, manufacture date code, serial no., and series name are marked on the external tube. The negative lead terminal is marked with black bands.

**Conversion table for manufacture date code**

Year	2010	'11	'12	'13	'14	'15	'16	'17	'18	'19	'20	'21
Indication	A	B	C	D	E	F	H	J	K	L	M	N
Month	1	2	3	4	5	6	7	8	9	10	11	12
Indication	1	2	3	4	5	6	7	8	9	O	N	D

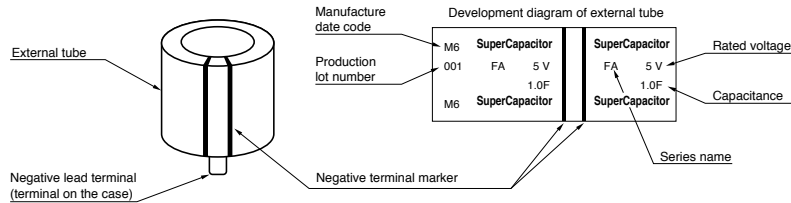

**Dimensions**

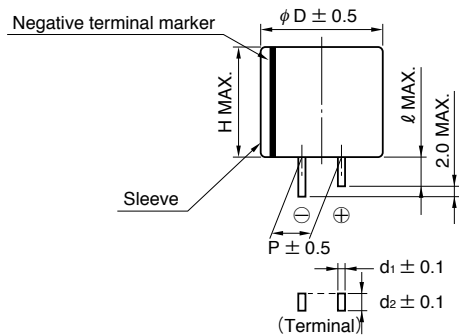

**Standard Ratings**

Part Number	MAX operating voltage (Vdc)	Rated voltage (Vdc)	Nominal capacitance		MAX ESR (at 1 kHz) ( $\Omega$ )	MAX current at 30 min. (mA)	Dimension (unit:mm)						Weight (g)
			Charge system (F)	Discharge system (F)			$\phi D$	H	P	$\ell$	$d_1$	$d_2$	
FA0H473ZF	5.5	5	0.047	0.075	20.0	0.071	16.0	15.5	5.1	5.0	0.4	1.2	6.2
FA0H104ZF	5.5	5	0.10	0.16	8.0	0.15	21.5	15.5	7.6	5.5	0.6	1.2	12
FA0H224ZF	5.5	5	0.22	0.35	5.0	0.33	28.5	16.5	10.2	9.5	0.6	1.4	25
FA0H474ZF	5.5	5	0.47	0.75	3.5	0.71	36.5	16.5	15.0	9.5	0.6	1.7	42
FA0H105ZF	5.5	5	1.0	1.6	2.5	1.5	44.5	18.5	20.0	9.5	1.0	1.4	65
FA1A223ZF	11.0	10	0.022	0.035	20.0	0.066	16.0	25.0	5.1	5.0	0.4	1.2	7.5
FA1A104ZF	11.0	10	0.10	0.16	8.0	0.30	28.5	25.5	10.2	9.5	0.6	1.4	32
FA1A224ZF	11.0	10	0.22	0.35	6.0	0.66	36.5	27.5	15.0	9.5	1.0	1.4	55
FA1A474ZF	11.0	10	0.47	0.75	4.0	1.41	44.5	28.5	20.0	9.5	1.0	1.4	83



- All specifications in this catalog and production status of products are subject to change without notice. Prior to the purchase, please contact TOKIN for updated product data.
- Please request for a specification sheet for detailed product data prior to the purchase.
- Before using the product in this catalog, please read "Precautions" and other safety precautions listed in the printed version catalog.



**FE Series**

**Marking**

Name of manufacturer, maximum operating voltage, capacitance, manufacture date code, serial no., and series name are marked on the external tube. The negative lead terminal is marked with black bands.

**Conversion table for manufacture date code**

Year	2010	'11	'12	'13	'14	'15	'16	'17	'18	'19	'20	'21
Indication	A	B	C	D	E	F	H	J	K	L	M	N
Month	1	2	3	4	5	6	7	8	9	10	11	12
Indication	1	2	3	4	5	6	7	8	9	O	N	D

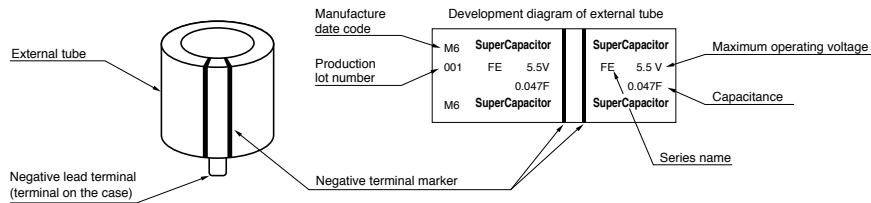

**Dimensions**

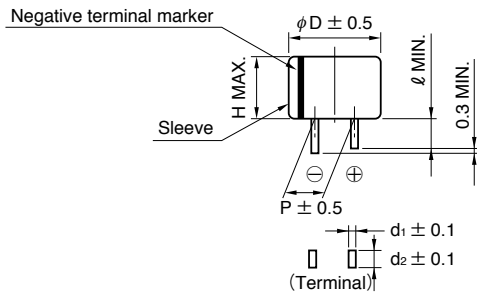

**Standard Ratings**

Part Number	MAX operating voltage (Vdc)	Nominal capacitance		MAX ESR (at 1 kHz) ( $\Omega$ )	MAX current at 30 min. (mA)	Dimension (unit:mm)						Weight (g)
		Charge system (F)	Discharge system (F)			$\phi D$	H	P	$\ell$	$d_1$	$d_2$	
FE0H473ZF	5.5	0.047	0.075	14.0	0.071	14.5	14.0	5.1	2.2	0.4	1.2	3.9
FE0H104ZF	5.5	0.10	0.16	6.5	0.15	16.5	14.0	5.1	2.7	0.4	1.2	5
FE0H224ZF	5.5	0.22	0.35	3.5	0.33	21.5	15.5	7.6	3.0	0.6	1.2	9.5
FE0H474ZF	5.5	0.47	0.75	1.8	0.71	28.5	16.5	10.2	6.1	0.6	1.4	16
FE0H105ZF	5.5	1.0	1.4	1.0	1.5	36.5	18.5	15.0	6.1	0.6	1.7	38
FE0H155ZF	5.5	1.5	2.1	0.6	2.3	44.5	18.5	20.0	6.1	1.0	1.4	72



- All specifications in this catalog and production status of products are subject to change without notice. Prior to the purchase, please contact TOKIN for updated product data.
- Please request for a specification sheet for detailed product data prior to the purchase.
- Before using the product in this catalog, please read "Precautions" and other safety precautions listed in the printed version catalog.

**Performance Characteristics**

Item	Series name	FA	FE	Test conditions (conforming to JIS C 5160-1)	
Category temperature range		-25°C to +70°C	-40°C to +70°C		
MAX operating voltage		5.5Vdc, 11Vdc	5.5Vdc		
Capacitance		5.5V : 0.047F to 1.0F 11V : 0.022F to 0.47F	0.047F to 1.5F	Refer to "Measurement Conditions"	
Capacitance allowance		+80% , -20%	+80% , -20%	Refer to "Measurement Conditions"	
ESR		Refer to standard ratings	Refer to standard ratings	Measured at 1kHz, 10mA ; See also "Measurement Conditions"	
Current (30-minutes value)		Refer to standard ratings	Refer to standard ratings	Refer to "Measurement Conditions"	
Surge	Capacitance	/	More than 90% of initial specified value	Surge voltage : 6.3V (5.5V type) : 12.6V (11V type) Charge : 30 sec. Discharge : 9min 30sec. Number of cycles : 1000 Series resistance : 0.047F : 0.10F : 0.22F : 0.47F : 1.0F, 1.5F Discharge resistance : 0Ω Temperature : 70±2°C	
	ESR		Less than 120% of initial specified value		
	Current (30 minutes value)		Less than 120% of initial specified value		
	Appearance		No obvious abnormality		
Characteristics in different temperature	Capacitance	Phase 2	More than 70% of initial measured value	Conforms to 4.17 Phase1 : +25±2°C Phase2 : -25±2°C Phase3 : -40±2°C (FE type) Phase4 : +25±2°C Phase5 : +70±2°C Phase6 : +25±2°C	
	ESR	Phase 2	Less than 300% of initial measured value		
	Capacitance	Phase 3	/		More than 40% of initial measured value
	ESR	Phase 3			Less than 400% of initial measured value
	Capacitance	Phase 5	Less than 150% of initial measured value		Less than 200% of initial measured value
	ESR	Phase 5	Satisfy initial specified value		Satisfy initial specified value
	Current (30 minutes value)	Phase 5	1.5CV (mA) or below		1.5CV (mA) or below
	Capacitance	Phase 6	Within ±20% of initial measured value		Within ±20% of initial measured value
	ESR	Phase 6	Satisfy initial specified value		Satisfy initial specified value
	Current (30 minutes value)	Phase 6	Satisfy initial specified value		Satisfy initial specified value
Lead strength (tensile)		No terminal damage	No terminal damage	Conforms to 4.9	
Vibration resistance	Capacitance	Satisfy initial specified value	Satisfy initial specified value	Conforms to 4.13 Frequency : 10 to 55 Hz Testing time : 6 hours	
	ESR				
	Current (30 minutes value)				
	Appearance				No obvious abnormality
Solderability		Over 3/4 of the terminal should be covered by the new solder	Over 3/4 of the terminal should be covered by the new solder	Conforms to 4.11 Solder temp : 245±5°C Dipping time : 5±0.5 sec. 1.6mm from the bottom should be dipped.	
Solder heat resistance	Capacitance	Satisfy initial specified value	Satisfy initial specified value	Conforms to 4.10 Solder temp : 260±10°C Dipping time : 10±1 sec. 1.6mm from the bottom should be dipped.	
	ESR				
	Current (30 minutes value)				
	Appearance				No obvious abnormality
Temperature cycle	Capacitance	Satisfy initial specified value	Satisfy initial specified value	Conforms to 4.12 Temperature condition : -25°C (-40°C for FE type) → Room temperature → +70°C → Room temperature Number of cycles : 5 Cycles	
	ESR				
	Current (30 minutes value)				
	Appearance				No obvious abnormality
High temp. and high humidity resistance	Capacitance	More than 90% of initial specified value	Within ±20% of initial measured value	Conforms to 4.14 Temperature : 40±2°C Relative humidity : 90 to 95% RH Testing time : 240±8 hours	
	ESR	Less than 120% of initial specified value	Less than 120% of initial specified value		
	Current (30 minutes value)	Less than 120% of initial specified value	Less than 120% of initial specified value		
	Appearance	No obvious abnormality	No obvious abnormality		
High temperature load	Capacitance	More than 85% of initial specified value	Within ±30% of initial measured value	Conforms to 4.15 Temperature : 70±2°C Voltage applied : MAX operating voltage Series protection resistance : 0Ω Testing time : 1000 <sup>±8</sup> Hours	
	ESR	Less than 120% of initial specified value	Less than 300% of initial specified value		
	Current (30 minutes value)	Less than 200% of initial specified value	Less than 200% of initial specified value		
	Appearance	No obvious abnormality	No obvious abnormality		



- All specifications in this catalog and production status of products are subject to change without notice. Prior to the purchase, please contact TOKIN for updated product data.
- Please request for a specification sheet for detailed product data prior to the purchase.
- Before using the product in this catalog, please read "Precautions" and other safety precautions listed in the printed version catalog.

**Typical Performance Data**

Resistive discharge characteristics (Backup time capability)

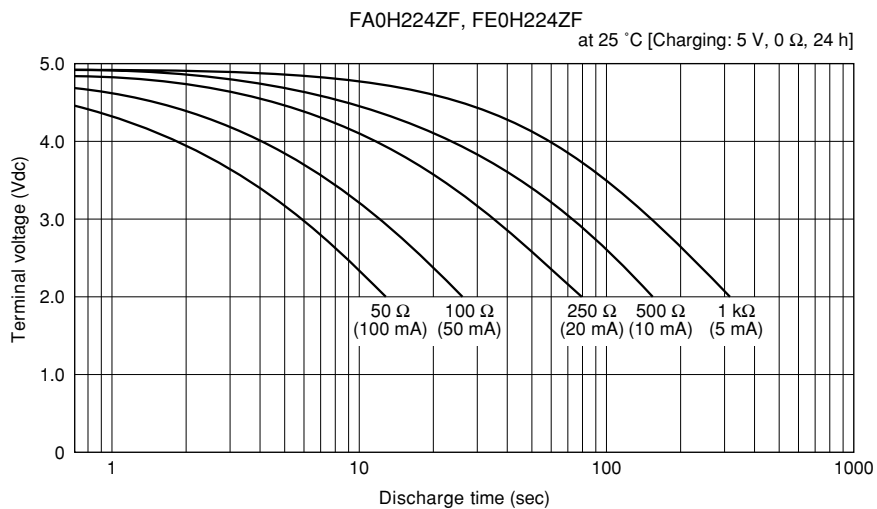
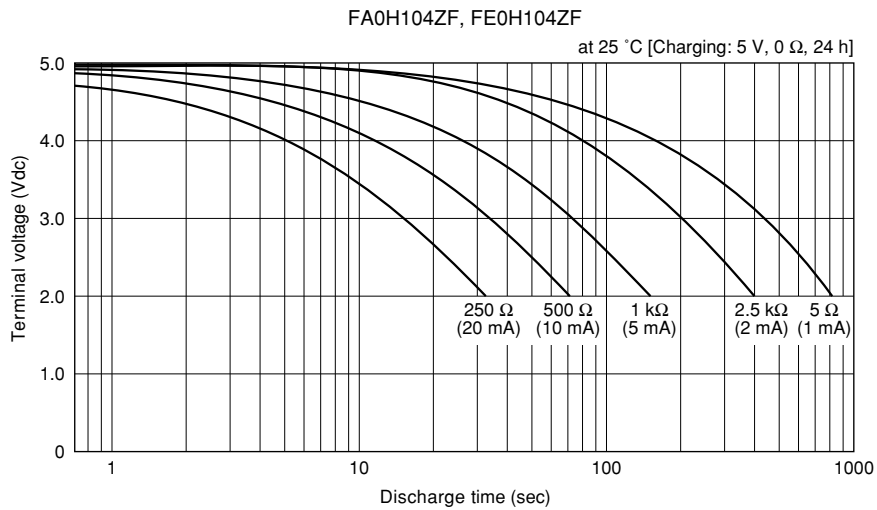
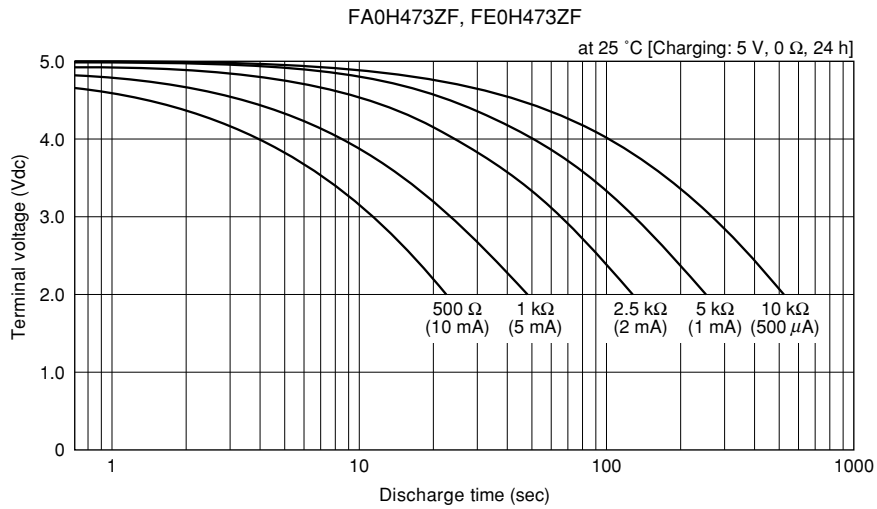

- All specifications in this catalog and production status of products are subject to change without notice. Prior to the purchase, please contact TOKIN for updated product data.
- Please request for a specification sheet for detailed product data prior to the purchase.
- Before using the product in this catalog, please read "Precautions" and other safety precautions listed in the printed version catalog.

**Resistive discharge characteristics (Backup time capability)**

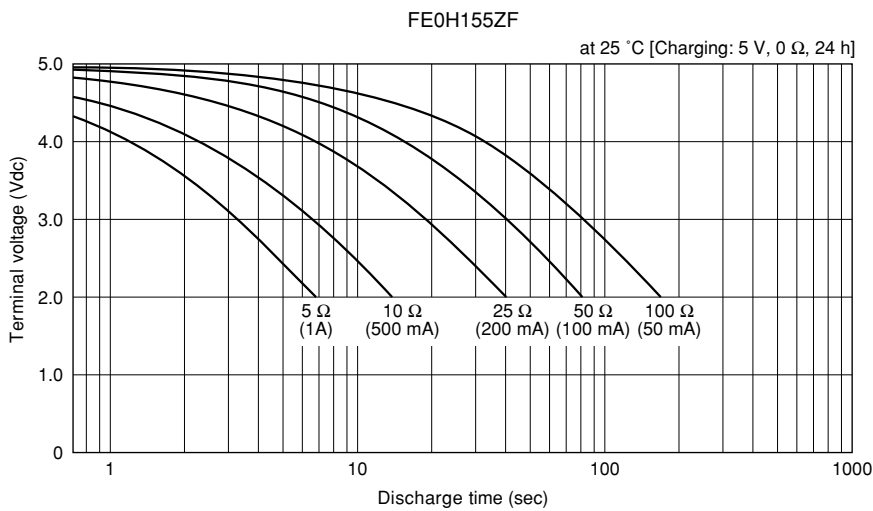
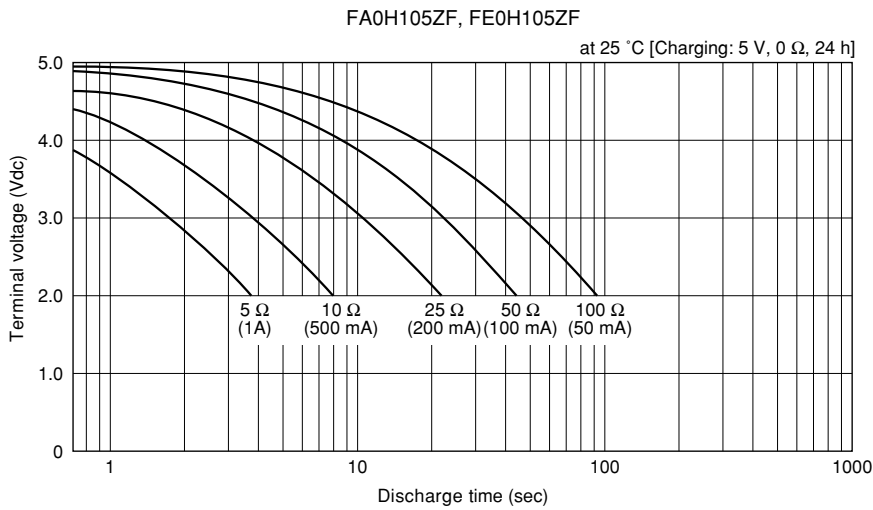
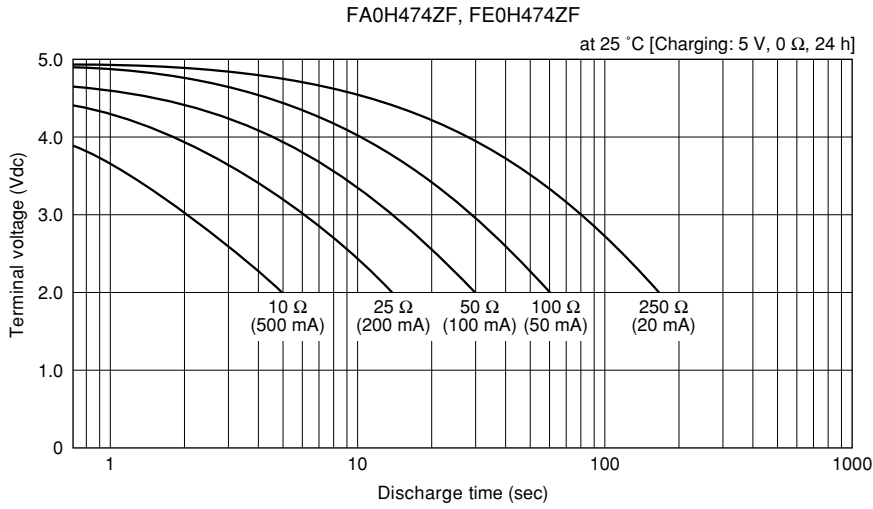

- All specifications in this catalog and production status of products are subject to change without notice. Prior to the purchase, please contact TOKIN for updated product data.
- Please request for a specification sheet for detailed product data prior to the purchase.
- Before using the product in this catalog, please read "Precautions" and other safety precautions listed in the printed version catalog.

**Resistive discharge characteristics (Backup time capability)**

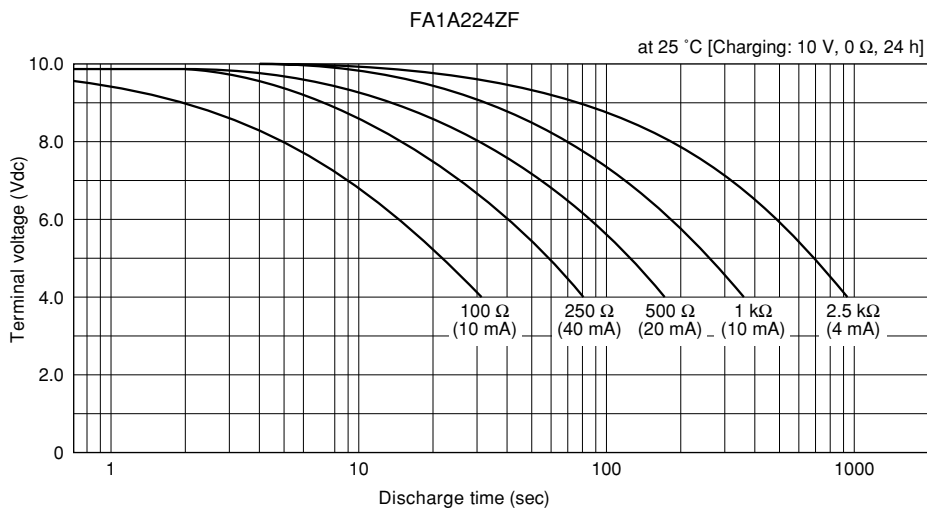
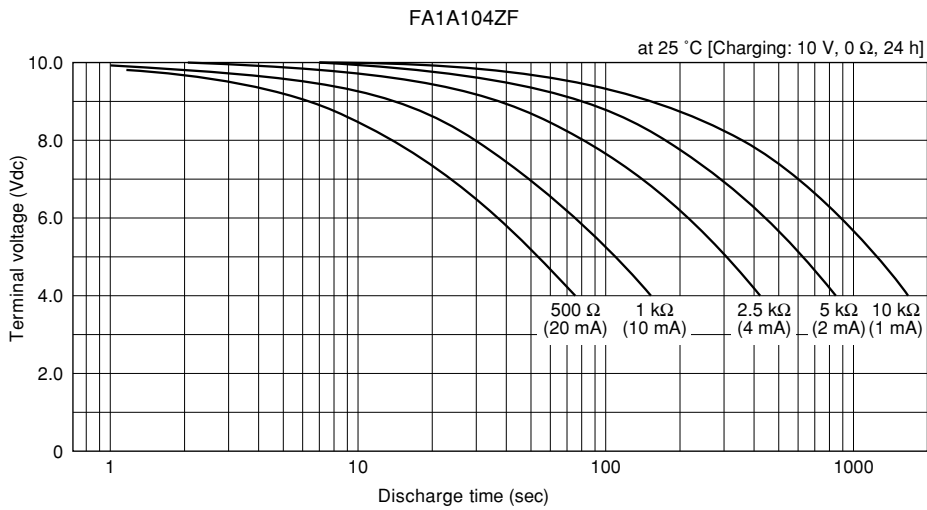
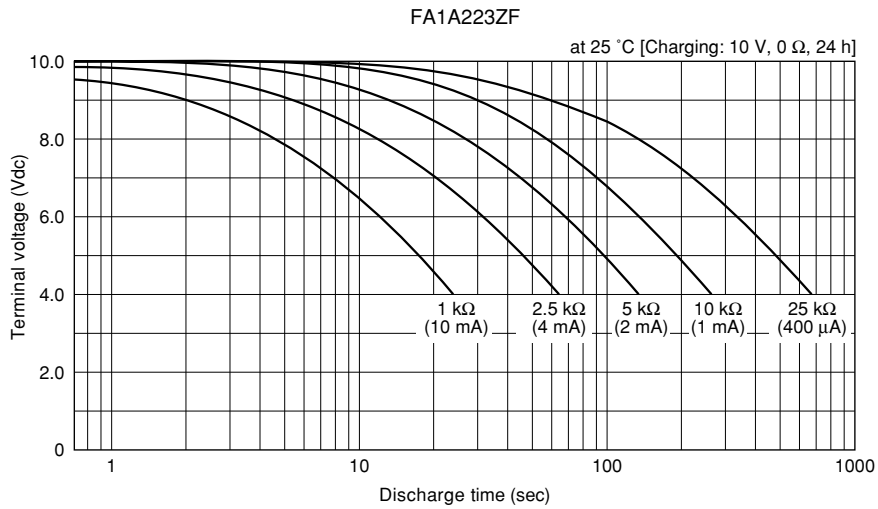

- All specifications in this catalog and production status of products are subject to change without notice. Prior to the purchase, please contact TOKIN for updated product data.
- Please request for a specification sheet for detailed product data prior to the purchase.
- Before using the product in this catalog, please read "Precautions" and other safety precautions listed in the printed version catalog.

Resistive discharge characteristics (Backup time capability)

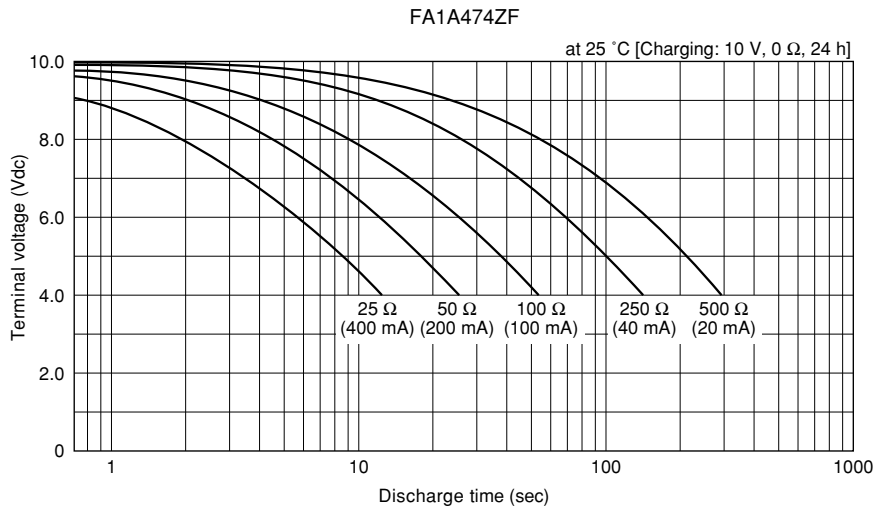

- All specifications in this catalog and production status of products are subject to change without notice. Prior to the purchase, please contact TOKIN for updated product data.
- Please request for a specification sheet for detailed product data prior to the purchase.
- Before using the product in this catalog, please read "Precautions" and other safety precautions listed in the printed version catalog.

# 18

## APPLICATION OF SuperCapacitor

### 1. Master Circuit

A master circuit using a SuperCapacitor is shown in the figure below.

Application examples of backup power source circuits for electric circuit operations and data preservation of microcomputers and memory devices during the power source interruption of products, of which examples are shown in the table, Example of power source interruption.

#### (1) Master circuit

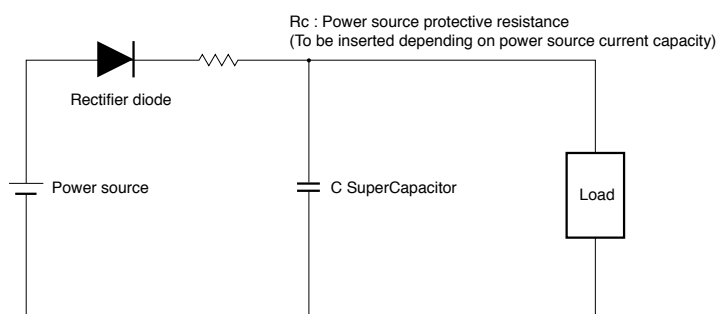

#### (2) Example of power source interruption

Category	Specific Example
Unanticipated power source	<ul style="list-style-type: none"> <li>• Power failure, unplugging, operation error interruption</li> <li>• Dislocation of batteries in battery box due to impact Unstable connection (2-(2) ex.)</li> <li>• Lack of sunlight on solar battery</li> </ul>
Anticipated power source	<ul style="list-style-type: none"> <li>• Turning off of power switch</li> <li>• Changing of battery interruption</li> </ul>



- All specifications in this catalog and production status of products are subject to change without notice. Prior to the purchase, please contact TOKIN for updated product data.
- Please request for a specification sheet for detailed product data prior to the purchase.
- Before using the product in this catalog, please read "Precautions" and other safety precautions listed in the printed version catalog.

**2. Backup Power Source During Source Interruption**

**(1) Backup during power source interruption of alternating current power source**

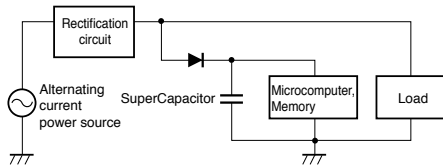

Even in the event of power source interruption due to power failure, operation error, etc., the power source of the memory component is backed up for a certain period of time so that data preserved in memory is not lost.

Example of products employing backup circuits:

- VTR
- Telephone set
- Radio equipment
- Office automation equipment
- Measurement, control
- Audio equipment
- (DTS)
- Others

**(2) Backup when power source is off**

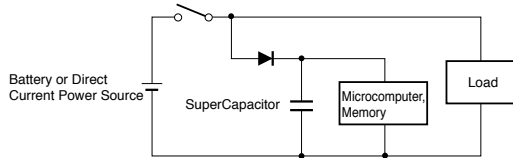

Even where memory and clock functions are preserved and operate for a certain time after the power source is off, the power source for such functions is backed up.

Example of products employing backup circuits:

- VTR camera
- Rice cooker with time display function
- On-vehicle (DTS)

**(3) Electronic circuit auxiliary power source**

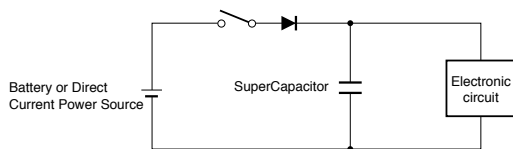

Operation of electronic circuit for certain time after power source is off.

Example of products employing backup circuits:

- Radio with timed listening function

**(4) Lighting of lamps or LEDs**

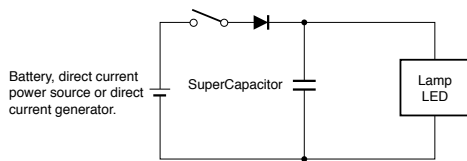

Lighting of lamp or LED during power failure or when power source is off, gradually darkening after a certain time.

Example of products employing backup circuits:

- Lights for bicycles, etc.
- Power failure display lamp

**(5) Motor drive**

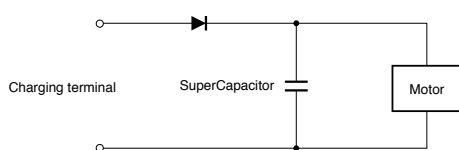

Discharge from SuperCapacitor, for low power source capacity and initiating initial torque.

Example of products employing backup circuits:

- FDD, HDD

**(6) Backup for solar batteries**

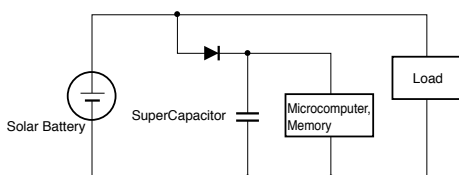

When the solar battery is not operating (when not subject to sunlight), back up of power source of memory component.

Example of products employing backup circuits:

- Calculator
- Electronic wristwatch
- Electronic stopwatch





**3. Backup Power Source During Source Power Source Voltage Drop Dueto Heavy Loading**

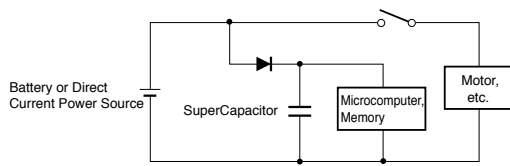

In the event of heavy loading (respective of motors, relays, etc.), as a large current becomes necessary instantaneously, if power source capacity is low, voltage declines and memory and electronic circuits sharing a power source may experience malfunction. Thus, memory and electronic circuit power sources are backed up instantaneously.

Example of products employing backup circuits:

- Single lens reflex camera
- Printer

**4. Backup Power Source for Products Using Batteries**

Regarding a product using a battery, as there are many cases where a battery is used as a backup power source, it is thought that a SuperCapacitor is unnecessary. However, in a case as in Figure 27, a SuperCapacitor is used.

**(1) Backup when changing battery**

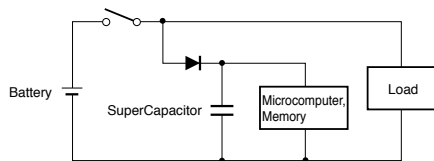

Temporary backup of power source of memory component, when changing a battery due to battery exhaustion, etc., in devices that normally operate by battery.

Example of products employing backup circuits:

- Portable word processor
- Handheld computer
- Camera
- Electronic taxi meter
- On-vehicle (DTS)

**(2) Backup for instantaneous disconnection due to unstable battery connection**

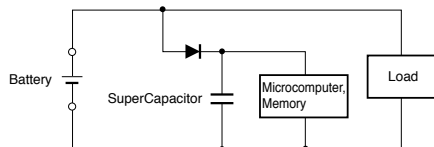

As the connection of batteries inserted into a battery box may undergo disconnection (instantaneous separation) due to vibration, impact, etc., power source backup for memory component is necessary.

Example of products employing backup circuits:

- Portable Terminal

**(3) Backup for microcomputers and memories while shifting from normal operation to standby mode**

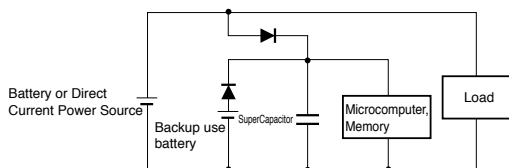

When shifting to standby during power failure, there are cases where it may be necessary to operate the microcomputers. Microcomputers with operation-guaranteed voltage of 5 +/-0.5 V cannot be operated with backup-use batteries. Because a voltage of backup-use batteries is usually 3.0 to 3.6 V, and is insufficient to operate microcomputers. In such case, with a SuperCapacitor, backup is possible while shifting to standby.

Example of products employing backup circuits:

- Portable Terminal



- All specifications in this catalog and production status of products are subject to change without notice. Prior to the purchase, please contact TOKIN for updated product data.
- Please request for a specification sheet for detailed product data prior to the purchase.
- Before using the product in this catalog, please read "Precautions" and other safety precautions listed in the printed version catalog.

**5. Use of Discharge Characteristics of Capacitors**

In the event of designing a power source in which voltage is gradually reduced, an extremely simple means of design may be realized by using discharge characteristics of a capacitor. In such case, where using TOKIN'S SuperCapacitors, the products become compact. Moreover, with SuperCapacitors, problems do not arise when charging and discharging is executed without protective resistance.

Where current capacity of the power source is small, it is necessary to have protective resistance in order to preserve the power source.

Figure 28 shows an application example of the use of discharge characteristics of a capacitor.

**(1) Operation of solenoid valve**

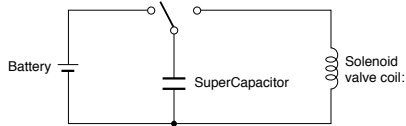

Use of discharge characteristics of a capacitor to operate a solenoid valve for a certain time.  
 Example of products employing backup circuits:  
 • Gas water heater  
 • Gas range

**(2) Gradual stopping of motor**

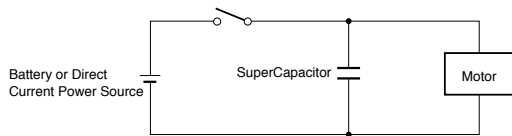

Gradual suspension of motor revolution during power failure or when power source is off  
 Example of products employing backup circuits:  
 • Mechanized Music Box



- All specifications in this catalog and production status of products are subject to change without notice. Prior to the purchase, please contact TOKIN for updated product data.
- Please request for a specification sheet for detailed product data prior to the purchase.
- Before using the product in this catalog, please read "Precautions" and other safety precautions listed in the printed version catalog.



- All specifications in this catalog and production status of products are subject to change without notice. Prior to the purchase, please contact TOKIN for updated product data.
- Please request for a specification sheet for detailed product data prior to the purchase.
- Before using the product in this catalog, please read "Precautions" and other safety precautions listed in the printed version catalog.



- All specifications in this catalog and production status of products are subject to change without notice. Prior to the purchase, please contact TOKIN for updated product data.
- Please request for a specification sheet for detailed product data prior to the purchase.
- Before using the product in this catalog, please read "Precautions" and other safety precautions listed in the printed version catalog.

# Precautions



- (1) Request for safety design of equipment and system, taking into account electronic component failures during operation

Generally, there is a certain probability of failures with electronic components. Despite the fact that we are striving to improve the quality and reliability of electronic components, it is impossible to reduce the probability of failure to 0. Therefore, when using our electronic component products, you are requested to perform safety design such as redundant design with respect to accidents resulting in injury or death, fire accidents, social damage, or fire prevention design or design preventing malfunction, etc. (For details of failure mode, see "Operating Precautions.")

- (2) Quality grade of components and applicable equipment

The product falls under the category of standard grade unless specified otherwise.

Our electronic component products are classified into three categories in low to high order of quality grade, [standard grade], [special grade], and [specific grade] in which case the customer specifies a quality assurance program separately.

Each quality grade indicates that the product is intended for the following applications:

If you are planning to use the product for applications other than those specified for the [standard grade], be sure to contact our sales representative in advance.

**Standard grade** :Computers, OA equipment, communications equipment, measurement equipment, AV equipment, domestic appliances, machine tools, personal equipment, industrial robots

**Special grade** :Transportation equipment (automobile, train, vessel, etc.), traffic signal equipment, anti-disaster/anti-crime devices, safety devices, medical equipment which is not directly intended for life support systems

**Specific grade** :Aircraft equipment, aerospace equipment, marine relay equipment, atomic power control systems, medical equipment for life support, devices or systems, etc.

When there is no indication of quality grade in documents of our electronic component products such as catalogs, data sheets, data books, etc., this means that the relevant product conforms to the standard grade.

- (3) This document is subject to change without notice.

The contents of this document are based on documents as of April 2017, and are subject to change without notice in the future. For volume production design, contact our sales representative by way of precaution.

- (4) No part of this document may be reprinted or copied without our written consent.

- (5) Industrial property

We will assume no responsibility for any infringement of third party's industrial property, etc. in relation to the use of this product except for cases involving the structure or manufacturing method of our products.

- (6) Export Control

For customers outside Japan

TOKIN products should not be used or sold for use in the development, production, stockpiling or utilization of any conventional weapons or mass-destructive weapons (nuclear weapons, chemical or biological weapons, or missiles), or any other weapons.

For customers in Japan

For products which are controlled items subject to the "Foreign Exchange and Foreign Trade Law" of Japan, the export license specified by the law is required for export.



- All specifications in this catalog and production status of products are subject to change without notice. Prior to the purchase, please contact TOKIN for updated product data.
- Please request for a specification sheet for detailed product data prior to the purchase.
- Before using the product in this catalog, please read "Precautions" and other safety precautions listed in the printed version catalog.