

Chip Monolithic Ceramic Capacitors for Automotive

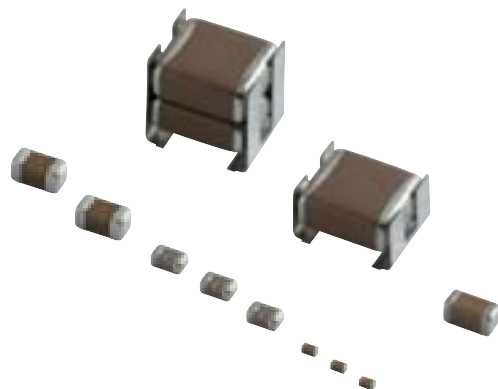

Explanation of Symbols in This Catalog

Ultra-compact L x W dimension: products of 0.6 x 0.3 mm or less

AEC-Q200 AEC-Q200 compliant product

Anti-noise Product suitable for acoustic noise reduction and low distortion
This product suppresses acoustic noise, which occurs when a ceramic capacitor is used, by devising the materials and configuration.

Fail safe Fail safe product
This capacitor is designed to prevent failures as much as possible by short mode.

Deflecting crack Product resistant to deflection cracking
This capacitor is designed to prevent failures as much as possible by short mode caused by cracking when there is board deflection.

Soldering crack Product with solder cracking suppression
This capacitor is configured with metal terminals or lead wires connected to the chip.
The metal terminals or lead wires relieve the stress from expansion and contraction of the solder, to suppress solder cracking.
Also, including capacitor which can be mounted with a conductive adhesive, instead of soldering.

EU RoHS Compliant

- All the products in this catalog comply with EU RoHS.
- EU RoHS is "the European Directive 2011/65/EU on the Restriction of the Use of Certain Hazardous Substances in Electrical and Electronic Equipment."
- For more details, please refer to our website 'Murata's Approach for EU RoHS' (<http://www.murata.com/info/rohs.html>).

Contents

Product specifications are as of March 2014.

Part Numbering	p2	
Selection Guide	p4	
Capacitance Table	p5	
		Cap. Table
<hr/>		
General Purpose Product		
GCM Series	p16	p6
<hr/>		
Specially Designed Product to Reduce Shorts GCD Series		
	p23	p10
<hr/>		
Specially Designed Product to Reduce Shorts & Resin Electrode Product		
GCE Series	p25	p10
<hr/>		
Conductivity Adhesive Compatible Type		
GCG Series	p27	p11
<hr/>		
Resin External Electrode Product		
GCJ Series	p32	p12
<hr/>		
High Effective Capacitance & High Allowable Ripple Current		
GC3 Series	p38	p14
<hr/>		
Metal Terminal Type KCM Series.....		
	p40	p14
<hr/>		
Metal Terminal Type/High Effective Capacitance & High Allowable Ripple Current KC3 Series		
	p43	p14
<hr/>		
⚠Caution/Notice	p46	
Introduction of Website SimSurfing	p66	
EMICON-FUN!	p67	
Product Information	p68	

Please check the MURATA home page (<http://www.murata.com/>) if you cannot find the part number in the catalog.

● Part Numbering

Chip Monolithic Ceramic Capacitors for Automotive

(Part Number)

GC	M	18	8	R7	1H	102	K	A37	D
①	②	③	④	⑤	⑥	⑦	⑧	⑨	⑩

① Product ID

② Series

Product ID	Code	Series
GC	3	High effective capacitance & High allowable ripple current
	D	Specially designed product to reduce shorts
	E	Specially designed product to reduce shorts & resin electrode product
	G	Conductivity adhesive compatible type
	J	Resin external electrode product
	M	For automotive
KC	3	Metal terminal type/High effective capacitance & High allowable ripple current
	M	Metal terminal type

③ Chip Dimension (L×W)

Code	Dimension (L×W)	EIA
03	0.6×0.3mm	0201
15	1.0×0.5mm	0402
18	1.6×0.8mm	0603
21	2.0×1.25mm	0805
31	3.2×1.6mm	1206
32	3.2×2.5mm	1210
43	4.5×3.2mm	1812
55	5.7×5.0mm	2220

⑤ Temperature Characteristics

Temperature Characteristic Codes			Temperature Characteristics			Operating Temperature Range	Capacitance Change Each Temperature (%)					
Code	Public STD Code	Reference Temperature	Temperature Range	Capacitance Change or Temperature Coefficient	-55°C		*3		-10°C			
					Max.		Min.	Max.	Min.	Max.	Min.	
5C	C0G	EIA	25°C	25 to 125°C	0±30ppm/°C	-55 to 125°C	0.58	-0.24	0.4	-0.17	0.25	-0.11
5G	X8G	*1	25°C	25 to 150°C	0±30ppm/°C	-55 to 150°C	0.58	-0.24	0.4	-0.17	0.25	-0.11
7U	U2J	EIA	25°C	25 to 125°C *2	-750±120ppm/°C	-55 to 125°C	8.78	5.04	6.04	3.47	3.84	2.21
9E	ZLM	*1	20°C	-25 to 20°C	-4700+1000/-2500ppm/°C	-55 to 125°C	-	-	-	-	-	-
				20 to 85°C	-4700+500/-1000ppm/°C		-	-	-	-	-	-
C7	X7S	EIA	25°C	-55 to 125°C	±22%	-55 to 125°C	-	-	-	-	-	-
D7	X7T	EIA	25°C	-55 to 125°C	+22%, -33%	-55 to 125°C	-	-	-	-	-	-
L8	X8L	*1	25°C	-55 to 150°C	+15%, -40%	-55 to 150°C	-	-	-	-	-	-
R7	X7R	EIA	25°C	-55 to 125°C	±15%	-55 to 125°C	-	-	-	-	-	-
R9	X8R	EIA	25°C	-55 to 150°C	±15%	-55 to 150°C	-	-	-	-	-	-

*1 Murata Temperature Characteristic Code.

*2 Rated Voltage 100Vdc max: 25 to 85°C

*3 -25°C (Reference Temperature 20°C) / -30°C (Reference Temperature 25°C)

Continued on the following page.

④ Height Dimension (T) (Except KC□)

Code	Dimension (T)
3	0.3mm
5	0.5mm
6	0.6mm
8	0.8mm
9	0.85mm
A	1.0mm
B	1.25mm
C	1.6mm
D	2.0mm
E	2.5mm
M	1.15mm
Q	1.5mm
X	Depends on individual standards.

④ Height Dimension (T) (KC□ Only)

Code	Dimension (T)
L	2.8mm
Q	3.7mm
T	4.8mm
W	6.4mm

(Part Number)

GC	M	18	8	R7	1H	102	K	A37	D
1	2	3	4	5	6	7	8	9	10

☐ Continued from the preceding page.

⑥ Rated Voltage

Code	Rated Voltage
0J	DC6.3V
1A	DC10V
1C	DC16V
1E	DC25V
YA	DC35V
1H	DC50V
1J	DC63V
1K	DC80V
2A	DC100V
2E	DC250V
2W	DC450V
2J	DC630V
3A	DC1kV

⑦ Capacitance

Expressed by three-digit alphanumerics. The unit is pico-farad (pF). The first and second figures are significant digits, and the third figure expresses the number of zeros that follow the two numbers.

If there is a decimal point, it is expressed by the capital letter "R."

In this case, all figures are significant digits.

If any letter, other than "R" is included, this indicates the specific part number is a non-standard part.

Ex.)

Code	Capacitance
R50	0.50pF
1R0	1.0pF
100	10pF
103	10000pF

⑧ Capacitance Tolerance

Code	Capacitance Tolerance
C	±0.25pF
D	±0.5pF
J	±5%
K	±10%
M	±20%

⑨ Individual Specification Code

Expressed by three figures.

⑩ Package

Code	Package
L	ø180mm Embossed Taping
D/W	ø180mm Paper Taping
K	ø330mm Embossed Taping
J	ø330mm Paper Taping
B	Bulk
C	Bulk Case

Please contact us if you find any part number not provided in this table.

Selection Guide for Chip Monolithic Ceramic Capacitors

	Series	Ultra-small (smaller than 0201)	Low dissipation/HiQ	Low ESL	Fail safe	Anti-deflecting crack	Anti-soldering crack	Anti-noise, low distortion	For bonding	Specific applications	Safety standard certified type
For Automotive	GCM <small>page p16</small>										
	GCD <small>p23</small>										
	GCE <small>p25</small>										
	GCG <small>p27</small>										
	GCJ <small>p32</small>										
	GC3 <small>p38</small>										
	KCM <small>p40</small>										
	KC3 <small>p43</small>										
For General Purpose	GRM										
	GA2										
	GA3										
	GJM										
	GJ4										
	GJ8										
	GMA										
	GMD										
	GQM										
	GRJ										
	GR3										
	GR4										
	GR7										
	KRM										
	KR3										
	LLA										
	LLL										
	LLM										
	LLR										
	ZRA										

Capacitance Table

How to read the Capacitance Table

LxW (mm)	0.6× 0.3	1.0× 0.5	1.6×0.8		
T max. (mm)	0.33	0.55	0.9		
Rated Voltage (Vdc)	25	50	100	50	10
Cap. / TC Code	C0G	C0G	C0G	C0G	C0
1.0pF	p17	p17	p17	p17	
2.0pF	p17	p17	p17	p17	
3.0pF	p17	p17	p17	p17	
4.0pF	p17	p17	p17	p17	
5.0pF	p17	p17	p17	p17	

→ The values can be narrowed down in the order of size, rated voltage, and temperature characteristics.

→ Refers to the page of the part number list.
Check the part number list for the applicable product number.

Temperature Characteristics Table

The Table is colored by temperature characteristic codes. Refer to the following Table for the meaning of each code.

Temperature Characteristic Codes		Temperature Characteristics			Operating Temperature Range	Capacitance Change Each Temperature (%)					
		Reference Temperature	Temperature Range	Capacitance Change or Temperature Coefficient		-55°C		*3		-10°C	
						Max.	Min.	Max.	Min.	Max.	Min.
C0G	EIA	25°C	25 to 125°C	0±30ppm/°C	-55 to 125°C	0.58	-0.24	0.4	-0.17	0.25	-0.11
X8G	*1	25°C	25 to 150°C	0±30ppm/°C	-55 to 150°C	0.58	-0.24	0.4	-0.17	0.25	-0.11
U2J	EIA	25°C	25 to 125°C *2	-750±120ppm/°C	-55 to 125°C	8.78	5.04	6.04	3.47	3.84	2.21
ZLM	*1	20°C	-25 to 20°C	-4700+1000/-2500ppm/°C	-55 to 125°C	-	-	-	-	-	-
			20 to 85°C	-4700+500/-1000ppm/°C		-	-	-	-	-	-
X7S	EIA	25°C	-55 to 125°C	±22%	-55 to 125°C	-	-	-	-	-	-
X7T	EIA	25°C	-55 to 125°C	+22%, -33%	-55 to 125°C	-	-	-	-	-	-
X8L	*1	25°C	-55 to 150°C	+15%, -40%	-55 to 150°C	-	-	-	-	-	-
X7R	EIA	25°C	-55 to 125°C	±15%	-55 to 125°C	-	-	-	-	-	-
X8R	EIA	25°C	-55 to 150°C	±15%	-55 to 150°C	-	-	-	-	-	-

*1 Murata Temperature Characteristic Code.

*2 Rated Voltage 100Vdc max: 25 to 85°C

*3 -25°C (Reference Temperature 20°C) / -30°C (Reference Temperature 25°C)

Capacitance Table

p00

Each number in the Part Number List refers to the page number printed at the bottom of the page.

■ GCM Series Temperature Compensating Type

p00 ← Part Number List

EIA: C0G U2J

Murata Temperature Characteristic: ZLM

LxW (mm)	0.6x0.3	1.0x0.5	1.6x0.8		2.0x1.25						3.2x1.6						3.2x2.5											
	T max. (mm)	0.33	0.55	0.9	0.7	0.95	1.0	1.4	1.45	0.95	1.0	1.25	1.8	1.0	1.25													
Rated Voltage (Vdc)	25	50	100	50	100	50	100	50	250	50	250	100	80	63	50	1000	630	250	1000	630	250	50	1000	630	630	1000		
Cap. / TC Code	C0G	C0G	C0G	C0G	C0G	C0G	ZLM	C0G	U2J	C0G	U2J	C0G	C0G	C0G	C0G	U2J	U2J	U2J	U2J	U2J	U2J	C0G	U2J	U2J	U2J	U2J		
1.0pF	p17	p17	p17	p17																								
2.0pF	p17	p17	p17	p17																								
3.0pF	p17	p17	p17	p17																								
4.0pF	p17	p17	p17	p17																								
5.0pF	p17	p17	p17	p17																								
6.0pF	p17	p17	p17	p17																								
7.0pF	p17	p17	p17	p17																								
8.0pF	p17	p17	p17	p17																								
9.0pF	p17	p17	p17	p18																								
10pF	p17	p17	p17	p18												p19	p19											
12pF	p17	p17	p17	p18												p19	p19											
15pF	p17	p17	p17	p18												p19	p19											
18pF	p17	p17	p17	p18												p19	p19											
22pF	p17	p17	p17	p18												p19	p19											
27pF	p17	p17	p17	p18												p19	p19											
33pF	p17	p17	p17	p18												p19	p19											
39pF	p17	p17	p17	p18												p19	p19											
47pF	p17	p17	p17	p18												p19	p19											
56pF	p17	p17	p17	p18												p19	p19											
68pF	p17	p17	p17	p18												p19	p19											
82pF	p17	p17	p17	p18												p19	p19											
100pF	p17	p17	p17	p18	p18						p18					p19	p19											
120pF		p17	p17	p18	p18						p18					p19	p19											
150pF		p17	p17	p18	p18						p18					p19	p19											
180pF		p17	p17	p18	p18						p18					p19	p19											
220pF		p17	p17	p18	p18						p18					p19	p19											
270pF		p17	p17	p18	p18						p18					p19	p19											
330pF		p17	p17	p18	p18						p18					p19	p19											
390pF		p17	p17	p18	p18						p18					p19	p19		p19									
470pF		p17	p17	p18	p18						p18					p19	p19		p19									
560pF			p17	p18	p18						p18					p19	p19		p19									
680pF			p17	p18	p18						p18					p19	p19		p19									
820pF			p17	p18	p18						p18					p19	p19						p19					
1000pF			p17	p18	p18	p18	p18	p18			p18					p19	p19						p19					
1100pF											p18																	
1200pF			p17	p18	p18	p18	p18	p18			p18					p19	p19									p19	p19	
1300pF											p18																	
1500pF			p17	p18	p18	p18	p18	p18			p18					p19	p19										p19	
1800pF				p18	p18	p18					p18					p19	p19										p19	
2200pF				p18	p18	p18					p18					p19	p19										p19	
2700pF				p18	p18	p18					p18	p19				p19	p19		p19		p19							
3300pF				p18	p18	p18					p18	p19				p19	p19		p19		p19							
3900pF				p18		p18					p18	p19				p19	p19		p19		p19					p19		
4700pF						p18					p18	p19				p19	p19		p19		p19					p19		
5600pF							p18				p18	p19				p19	p19		p19		p19							
6800pF								p18				p19				p19	p19				p19							
8200pF									p18			p19				p19	p19				p19							
10000pF										p18			p19			p19	p19				p19							
12000pF											p18					p19	p19				p19							
15000pF												p18				p19	p19				p19							
18000pF													p18				p19	p19				p19						
22000pF														p18				p19	p19									
27000pF																		p19	p19									
33000pF																			p19	p19								
39000pF																				p19	p19							
47000pF																												
56000pF																												



Capacitance Table p00 Each number in the Part Number List refers to the page number printed at the bottom of the page.

(→ ■ GCM Series Temperature Compensating Type)

p00 ← Part Number List EIA: C0G U2J Murata Temperature Characteristic: ZLM

3.2x2.5			4.5x3.2				5.7x5.0				LxW (mm)		
1.25	1.5	2.0	1.5	2.0	1.5	2.0	1.5	2.0	1.5	2.0	1.5	2.0	T max. (mm)
630	1000	630	1000	630	1000	630	1000	630	1000	630	1000	630	Rated Voltage (Vdc)
U2J	U2J	U2J	U2J	U2J	U2J	U2J	U2J	U2J	U2J	U2J	U2J	U2J	Cap. / TC Code
													1.0pF
													2.0pF
													3.0pF
													4.0pF
													5.0pF
													6.0pF
													7.0pF
													8.0pF
													9.0pF
													10pF
													12pF
													15pF
													18pF
													22pF
													27pF
													33pF
													39pF
													47pF
													56pF
													68pF
													82pF
													100pF
													120pF
													150pF
													180pF
													220pF
													270pF
													330pF
													390pF
													470pF
													560pF
													680pF
													820pF
													1000pF
													1100pF
													1200pF
													1300pF
													1500pF
													1800pF
													2200pF
													2700pF
													3300pF
													3900pF
													4700pF
													5600pF
													6800pF
													8200pF
													10000pF
													12000pF
													15000pF
													18000pF
													22000pF
													27000pF
													33000pF
													39000pF
													47000pF
													56000pF

Capacitance Table p00 Each number in the Part Number List refers to the page number printed at the bottom of the page.

■ GCM Series High Dielectric Constant Type

p00 ← Part Number List EIA: X7S X7R

LxW (mm)	0.6x0.3			1.0x0.5				1.6x0.8					2.0x1.25								3.2x1.6						
T max. (mm)	0.33			0.55				0.9					0.7	0.95				1.4				0.95	1.25				
Rated Voltage (Vdc)	25	16	10	100	50	25	16	100	50	25	16	6.3	100	100	50	25	16	100	50	35	25	16	10	6.3	100	100	
Cap. / TC Code	X7R	X7R	X7R	X7R	X7R	X7R	X7R	X7R	X7R	X7R	X7R	X7R	X7R	X7R	X7R	X7R	X7R	X7R	X7R	X7R	X7R	X7R	X7R	X7R	X7R	X7R	
100pF	p21																										
150pF	p21																										
220pF	p21			p21	p21																						
330pF	p21			p21	p21																						
470pF	p21			p21	p21																						
680pF	p21			p21	p21																						
1000pF	p21			p21	p21			p21	p21																		
1500pF	p21			p21	p21			p21	p21																		
2200pF		p21		p21	p21			p21	p21																		
3300pF		p21		p21	p21			p21	p21																		
4700pF			p21	p21	p21			p21	p21																		
6800pF			p21		p21			p21	p21				p21														
10000pF			p21		p21	p21		p21	p21				p21														
15000pF					p21	p21		p21	p21				p21														
22000pF					p21	p21		p21	p21				p21														
33000pF					p21	p21	p21		p21	p21				p22	p22												
47000pF					p21	p21	p21		p21	p21								p22	p22								
68000pF					p21		p21		p21	p21								p22	p22								
0.10μF					p21		p21		p21	p21	p21							p22	p22							p22	
0.15μF							p21		p21	p21								p22	p22			p22					p22
0.22μF							p21		p21	p21								p22	p22			p22					p22
0.33μF											p21					p22						p22					
0.47μF										p21	p21					p22					p22						
0.68μF																		p22			p22	p22					
1.0μF										p21	p21						p22			p22	p22	p22					
1.5μF																				p22							
2.2μF												p21									p22	p22	p22				
4.7μF																						p22	p22				
10μF																							p22	p22			
22μF																								p22	p22		
47μF																											



Capacitance Table p00 Each number in the Part Number List refers to the page number printed at the bottom of the page.

(→ ■ GCM Series High Dielectric Constant Type)

p00 ← Part Number List EIA: X7S X7R

3.2x1.6									3.2x2.5									LxW (mm)
1.25	1.3	1.8						1.9	2.2	2.7						T max. (mm)		
50	25	100	50	25	16	10	6.3	25	25	16	50	35	25	16	10	6.3	Rated Voltage (Vdc)	
X7R	X7R	X7R	X7Δ	X7R	X7R	X7R	X7R	X7S	X7R	X7R	X7Δ	X7S	X7R	X7R	X7R	X7R	Cap. / TC Code	
																	100pF	
																	150pF	
																	220pF	
																	330pF	
																	470pF	
																	680pF	
																	1000pF	
																	1500pF	
																	2200pF	
																	3300pF	
																	4700pF	
																	6800pF	
																	10000pF	
																	15000pF	
																	22000pF	
																	33000pF	
																	47000pF	
																	68000pF	
																	0.10μF	
																	0.15μF	
																	0.22μF	
																	0.33μF	
																	0.47μF	
																	0.68μF	
																	1.0μF	
																	1.5μF	
																	2.2μF	
																	4.7μF	
																	10μF	
																	22μF	
																	47μF	

Capacitance Table

p00

Each number in the Part Number List refers to the page number printed at the bottom of the page.

■ GCD Series High Dielectric Constant Type

p00 ← Part Number List EIA: X7R

LxW (mm)	1.6x0.8			2.0x1.25				
	T max. (mm)			T max. (mm)				
Rated Voltage (Vdc)	100	50	25	100	50	100	100	50
Cap. / TC Code	X7R	X7R	X7R	X7R	X7R	X7R	X7R	X7R
1000pF	p24	p24		p24	p24			
1200pF	p24	p24		p24	p24			
1500pF	p24	p24		p24	p24			
1800pF	p24	p24		p24	p24			
2200pF	p24	p24		p24	p24			
2700pF	p24	p24		p24	p24			
3300pF	p24	p24		p24	p24			
3900pF	p24	p24		p24	p24			
4700pF	p24	p24		p24	p24			
5600pF	p24	p24		p24	p24			
6800pF	p24	p24				p24		
8200pF	p24	p24					p24	
10000pF	p24	p24					p24	
12000pF	p24	p24					p24	
15000pF	p24	p24					p24	p24
18000pF	p24	p24					p24	p24
22000pF	p24	p24					p24	p24
27000pF			p24				p24	p24
33000pF			p24				p24	p24
39000pF			p24				p24	p24
47000pF			p24				p24	p24
56000pF							p24	p24
68000pF							p24	p24
82000pF							p24	p24
0.10μF							p24	p24

■ GCE Series High Dielectric Constant Type

p00 ← Part Number List EIA: X7R

LxW (mm)	1.6x0.8			2.0x1.25			
	T max. (mm)			T max. (mm)			
Rated Voltage (Vdc)	100	50	100	50	100	100	50
Cap. / TC Code	X7R	X7R	X7R	X7R	X7R	X7R	X7R
1000pF	p26	p26	p26	p26			
1200pF	p26	p26	p26	p26			
1500pF	p26	p26	p26	p26			
1800pF	p26	p26	p26	p26			
2200pF	p26	p26	p26	p26			
2700pF	p26	p26	p26	p26			
3300pF	p26	p26	p26	p26			
3900pF	p26	p26	p26	p26			
4700pF	p26	p26	p26	p26			
5600pF	p26	p26	p26	p26			
6800pF	p26	p26			p26		
8200pF	p26	p26				p26	
10000pF	p26	p26				p26	
12000pF	p26	p26				p26	
15000pF	p26	p26				p26	p26
18000pF	p26	p26				p26	p26
22000pF	p26	p26				p26	p26
27000pF						p26	p26
33000pF						p26	p26
39000pF						p26	p26
47000pF						p26	p26
56000pF						p26	p26
68000pF						p26	p26
82000pF						p26	p26
0.10μF						p26	p26

Capacitance Table

p00

Each number in the Part Number List refers to the page number printed at the bottom of the page.

■ GCG Series

Temperature Compensating Type

p00 ← Part Number List

Murata Temperature Characteristic: X8G

LxW (mm)	1.0x0.5		1.6x0.8		2.0x1.25	
	0.55	0.9	0.7	0.95		
T max. (mm)	0.55	0.9	0.7	0.95		
Rated Voltage (Vdc)	50	50	50	50		
Cap. / TC Code	X8G	X8G	X8G	X8G		
10pF		p28				
12pF		p28				
15pF		p28				
18pF		p28				
22pF		p28				
27pF		p28				
33pF		p28				
39pF		p28				
47pF		p28				
56pF		p28				
68pF		p28				
82pF		p28				
100pF		p28	p28			
120pF	p28	p28	p28			
150pF	p28	p28	p28			
180pF	p28	p28	p28			
220pF	p28	p28	p28			
270pF	p28	p28	p28			
330pF	p28	p28	p28			
390pF	p28	p28	p28			
470pF	p28	p28	p28			
560pF		p28	p28			
680pF		p28	p28			
820pF		p28	p28			
1000pF		p28	p28			
1200pF		p28	p28			
1500pF		p28	p28			
1800pF		p28	p28			
2200pF		p28	p28			
2700pF			p28			
3300pF			p28			
3900pF			p28			
4700pF			p28			
5600pF						p28
6800pF						p28
8200pF						p28
10000pF						p28

High Dielectric Constant Type

EIA: X7R X8R

Murata Temperature Characteristic: X8L

LxW (mm)	1.0x0.5					1.6x0.8						2.0x1.25		
	0.55					0.9						0.95		
T max. (mm)	0.55					0.9						0.95		
Rated Voltage (Vdc)	50	25	16	100	50	25	16	50	25					
Cap. / TC Code	X7R	X8L	X7R	X8L	X7R	X8R	X8L	X8R	X7R	X8R	X7R	X8L	X8R	X8R
220pF	p29						p29							
270pF	p29						p29							
330pF	p29						p29							
390pF	p29						p29							
470pF	p29						p29							
560pF	p29						p29							
680pF	p29						p29							
820pF	p29						p29							
1000pF	p29						p29	p29			p30			
1200pF	p29						p29	p29	p29		p30			
1500pF	p29						p29	p29	p29		p30			
1800pF	p29						p29	p29			p30			
2200pF	p29						p29	p29	p29		p30			
2700pF	p29						p29	p29	p29		p30			
3300pF	p29						p29	p29	p29		p30			
3900pF	p29						p29	p29	p29		p30			
4700pF	p29						p29	p29	p29		p30			
5600pF		p29	p29				p29	p29	p29		p30			
6800pF		p29	p29				p29	p29	p29		p30			
8200pF		p29	p29				p29	p29	p29		p30			
10000pF		p29	p29				p29	p29	p30		p30			p30 p30
12000pF							p29	p29						
15000pF			p29	p29	p29	p29	p29	p30			p30			p30 p30
18000pF			p29	p29	p29	p29	p29							p30
22000pF			p29	p29	p29	p29	p29	p30			p30			p30 p30
27000pF			p29	p29	p29				p30					
33000pF			p29	p29	p29				p30	p30	p30			
39000pF			p29	p29	p29					p30				
47000pF			p29	p29	p29				p30	p30	p30			
56000pF				p29	p29					p30				
68000pF				p29	p29					p30	p30			p30
82000pF				p29						p30				
0.10μF				p29						p30				p30
0.12μF										p30				
0.15μF										p30			p30	
0.18μF										p30			p30	
0.22μF										p30			p30	
0.27μF														
0.33μF											p30			
0.39μF											p30			
0.47μF											p30			
0.56μF														
0.68μF														
0.82μF														
1.0μF														
1.2μF														
1.5μF														
2.2μF														
3.3μF														
3.9μF														
4.7μF														
10μF														



Capacitance Table

p00

Each number in the Part Number List refers to the page number printed at the bottom of the page.

(→ ■ GCG Series High Dielectric Constant Type)

p00 ← Part Number List

EIA: X7R X8R Murata Temperature Characteristic: X8L

LxW (mm)	2.0x1.25						3.2x1.6						3.2x2.5		
	1.45						1.35			1.9			2.3	2.8	
T max. (mm)	1.45						1.35			1.9			2.3	2.8	
Rated Voltage (Vdc)	50		25		16		50	25	16	25	16	25	25		
Cap. / TC Code	X8L	X8R	X7R	X8L	X8R	X7R	X8L	X7R	X8R	X8R	X7R	X8L	X8R	X7R	X7R
220pF															
270pF															
330pF															
390pF															
470pF															
560pF															
680pF															
820pF															
1000pF															
1200pF															
1500pF															
1800pF															
2200pF															
2700pF															
3300pF															
3900pF															
4700pF															
5600pF															
6800pF															
8200pF															
10000pF															
12000pF															
15000pF															
18000pF															
22000pF															
27000pF	p30														
33000pF	p30	p30			p30										
39000pF	p30				p30										
47000pF	p30	p30			p30										
56000pF		p30													
68000pF		p30													
82000pF					p30										
0.10μF	p30	p30		p30	p30										
0.12μF															
0.15μF			p30		p30			p30	p30						
0.18μF			p30		p30										
0.22μF			p30		p30			p30	p30						
0.27μF						p30									
0.33μF			p30		p30	p30		p30	p30						
0.39μF					p30	p30									
0.47μF					p30	p30									
0.56μF					p30	p30									
0.68μF					p30	p30					p31			p31	
0.82μF					p30	p30									
1.0μF					p30					p30	p31				p31
1.2μF										p31					
1.5μF										p31	p31				
2.2μF										p31					
3.3μF												p31	p31		p31
3.9μF												p31			
4.7μF								p30				p31	p31		
10μF															p31

△Note • Please read rating and △CAUTION (for storage, operating, rating, soldering, mounting and handling) in this catalog to prevent smoking and/or burning, etc.
 • This catalog has only typical specifications. Therefore, please approve our product specifications or transact the approval sheet for product specifications before ordering.

Capacitance Table

p00

Each number in the Part Number List refers to the page number printed at the bottom of the page.

GCJ Series High Dielectric Constant Type

p00 ← Part Number List

EIA: X7S X7R X8R

Murata Temperature Characteristic: X8L

LxW (mm)	1.6x0.8												2.0x1.25											
	0.9												0.7			0.95			1.0		1.45			
T max. (mm)	0.9												0.7			0.95			1.0		1.45			
Rated Voltage (Vdc)	100	50			35	25			16	10	6.3	100	50	25	100	50	25	16	250	250	100	50	35	
Cap. / TC Code	X8R	X7R	X8L	X8R	X7R	X8L	X8L	X8R	X7R	X8L	X7R	X7R	X7R	X7R	X7R	X7R	X7R	X7R	X7R	X7R	X7R	X8L	X7R	X8L
220pF																								
270pF																								
330pF																								
390pF																								
470pF																								
560pF																								
680pF																								
820pF																								
1000pF	p33	p33	p33		p33						p34			p34	p34	p35								p35
1200pF	p33	p33	p33		p33						p34			p34	p34	p35								
1500pF	p33	p33	p33		p33						p34			p34	p34	p35								p35
1800pF	p33	p33	p33		p33						p34			p34	p34	p35								
2200pF	p33	p33	p33		p33						p34			p34	p34	p35								p35
2700pF	p33	p33	p33		p33						p34			p34	p34	p35								
3300pF	p33	p33	p33		p33						p34			p34	p34	p35								p35
3900pF	p33	p33	p33		p33						p34			p34	p34	p35								
4700pF	p33	p33	p33	p33	p33						p34			p34	p34	p35								p35
5600pF	p33	p33	p33		p33						p34			p34	p34	p35								
6800pF	p33	p33	p33		p33						p34			p34	p34	p35								p35
8200pF	p33	p33	p33		p33						p34			p34	p34	p35								
10000pF	p33	p33	p33	p33	p33						p34		p34											p35
12000pF	p33	p33	p33		p33						p34			p34	p34	p35								
15000pF	p33	p33	p33		p33						p34			p34	p34					p35				p35
18000pF	p33	p33	p33		p33						p34			p34	p34					p35				
22000pF	p33	p33	p33		p33						p34			p34	p34					p35				p35
27000pF	p33										p34		p34						p35	p35				p35
33000pF	p33				p33	p33	p33				p34	p34	p34						p35	p35				p35
39000pF	p33				p33	p33	p33				p34	p34	p34						p35	p35				p35
47000pF	p33				p33						p34	p34	p34									p35	p35	p35
56000pF	p33				p33	p33	p33				p34	p34	p34									p35	p35	p35
68000pF	p33				p33	p33	p33				p34	p34	p34									p35	p35	p35
82000pF					p33		p33				p34	p34	p34									p35	p35	p35
0.10µF		p33		p33	p33						p34	p34	p34									p35	p35	p35
0.12µF			p33								p34	p34	p34	p34									p35	p35
0.15µF			p33	p33				p33			p34	p34	p34	p34									p35	p35
0.18µF			p33					p33			p34	p34	p34	p34									p35	p35
0.22µF			p33	p33				p33			p34	p34	p34	p34									p35	p35
0.27µF													p34											
0.33µF									p33				p34						p35	p35				p35
0.39µF									p33				p34											
0.47µF									p33				p34							p35			p35	p35
0.56µF																								
0.68µF																								
0.82µF																								
1.0µF											p34													p35
1.5µF																								
2.2µF																								
3.3µF																								
4.7µF																								
6.8µF																								
10µF																								
22µF																								
47µF																								



Capacitance Table

p00

Each number in the Part Number List refers to the page number printed at the bottom of the page.

(→ ■ GCJ Series High Dielectric Constant Type)

p00 ← Part Number List

EIA: X7S X7R X8R

Murata Temperature Characteristic: X8L

LxW (mm)	2.0x1.25										3.2x1.6													
	1.45					0.95		1.25			1.35		1.8			1.9								
T max. (mm)	1.45					0.95		1.25			1.35		1.8			1.9								
Rated Voltage (Vdc)	25	16	10	100	50	100	50	1000	630	250	100	50	25	16	1000	630	250	100	50	35	25	16	10	6.3
Cap. / TC Code	X8L	X7R	X8L	X7R	X7R	X7R	X7R	X7R	X7R	X7R	X7R	X7R	X7R	X7R	X7R	X7R	X7R	X7R	X7R	X7R	X7R	X7R	X7R	X7R
220pF																								
270pF																								
330pF																								
390pF																								
470pF																								
560pF																								
680pF																								
820pF																								
1000pF									p36	p36														
1200pF																								
1500pF									p36	p36														
1800pF																								
2200pF									p36	p36														
2700pF																								
3300pF									p36	p36														
3900pF																								
4700pF									p36	p36														
5600pF																								
6800pF									p36						p36									
8200pF																								
10000pF									p36						p36									
12000pF																								
15000pF										p36						p36								
18000pF																								
22000pF										p36						p36								
27000pF		p35																						
33000pF		p35															p36							
39000pF		p35																						
47000pF		p35															p36							
56000pF		p35																						
68000pF		p35							p36															
82000pF		p35																						
0.10μF		p35				p36	p36					p36				p36								
0.12μF	p35						p36					p36												
0.15μF	p35									p36	p36	p36												
0.18μF	p35									p36	p36	p36												
0.22μF	p35									p36	p36	p36												
0.27μF	p35	p35			p36						p36													
0.33μF	p35				p36						p36													
0.39μF	p35	p35			p36						p36													
0.47μF	p35				p36						p36													
0.56μF		p35	p35		p36						p36													
0.68μF	p35	p35	p36								p36									p36	p36			
0.82μF	p35	p35	p36								p36									p36	p36			
1.0μF	p35	p35	p36	p36							p36	p36	p36				p36			p36	p36			
1.5μF		p35										p36	p36							p36				
2.2μF		p35			p36	p36						p36								p36				
3.3μF												p36												
4.7μF					p36															p36				
6.8μF																					p36	p36		
10μF						p36																p36	p36	
22μF																								p36
47μF																								



Capacitance Table p00 Each number in the Part Number List refers to the page number printed at the bottom of the page.

(→ ■ GCJ Series High Dielectric Constant Type)

p00 ← Part Number List EIA: X7S X7R X8R Murata Temperature Characteristic: X8L

3.2x1.6	3.2x2.5											4.5x3.2					5.7x5.0			LxW (mm)
2.0	1.5		2.0		2.3	2.8				1.5		2.0			2.0			T max. (mm)		
25	630	250	1000	630	250	100	50	25	16	6.3	630	250	1000	630	250	1000	630	250	Rated Voltage (Vdc)	
X7S	X7R	X7R	X7R	X7R	X7R	X7R	X7Δ	X8L	X7R	X7R	X7R	X7R	X7R	X7R	X7R	X7R	X7R	X7R	X7R	Cap. / TC Code
																				220pF
																				270pF
																				330pF
																				390pF
																				470pF
																				560pF
																				680pF
																				820pF
																				1000pF
																				1200pF
																				1500pF
																				1800pF
																				2200pF
																				2700pF
																				3300pF
																				3900pF
																				4700pF
																				5600pF
																				6800pF
																				8200pF
																				10000pF
																				12000pF
																				15000pF
																				18000pF
																				22000pF
																				27000pF
																				33000pF
																				39000pF
																				47000pF
																				56000pF
																				68000pF
																				82000pF
																				0.10μF
																				0.12μF
																				0.15μF
																				0.18μF
																				0.22μF
																				0.27μF
																				0.33μF
																				0.39μF
																				0.47μF
																				0.56μF
																				0.68μF
																				0.82μF
																				1.0μF
																				1.5μF
																				2.2μF
																				3.3μF
																				4.7μF
																				6.8μF
																				10μF
																				22μF
																				47μF

Capacitance Table

p00

Each number in the Part Number List refers to the page number printed at the bottom of the page.

GC3 Series High Dielectric Constant Type

p00 ← Part Number List EIA: X7T

LxW (mm)	2.0x1.25				3.2x1.6						3.2x2.5				4.5x3.2				5.7x5.0						
	T max. (mm)		1.0		1.0		1.25		1.8		1.5		2.0		1.5		2.0		2.0			2.7			
Rated Voltage (Vdc)	250	250	450	250	630	450	250	630	450	250	630	250	630	450	250	250	630	450	250	630	450	250	630	450	250
Cap. / TC Code	X7T	X7T	X7T	X7T	X7T	X7T	X7T	X7T	X7T	X7T	X7T	X7T	X7T	X7T	X7T	X7T	X7T	X7T	X7T	X7T	X7T	X7T	X7T	X7T	X7T
10000pF	p39		p39		p39																				
15000pF	p39		p39				p39																		
22000pF		p39			p39						p39														
33000pF			p39		p39							p39													
47000pF						p39		p39					p39												
68000pF									p39					p39			p39								
0.10μF										p39				p39					p39						
0.15μF														p39			p39			p39					
0.22μF															p39					p39		p39			
0.27μF																					p39				
0.33μF																			p39		p39				
0.47μF																				p39	p39				
0.56μF																							p39		
0.68μF																						p39			
1.0μF																								p39	

KCM Series High Dielectric Constant Type

p00 ← Part Number List EIA: X7R

LxW (mm)	6.1x5.3																								
	3.0					3.9					5.0					6.7									
T max. (mm)	100					63					50					35					25				
Rated Voltage (Vdc)	100	63	50	35	25	100	63	50	35	25	100	50	35	25	100	63	50	35	25	100	63	50	35	25	
Cap. / TC Code	X7R	X7R	X7R	X7R	X7R	X7R	X7R	X7R	X7R	X7R	X7R	X7R	X7R	X7R	X7R	X7R	X7R	X7R	X7R	X7R	X7R	X7R	X7R	X7R	
4.7μF	p42	p42	p42																						
6.8μF					p42																				
10μF			p42	p42				p42						p42											
15μF				p42	p42														p42						
17μF								p42	p42																
22μF									p42	p42				p42	p42				p42						
33μF										p42					p42	p42									
47μF																					p42	p42			
68μF																							p42		

KC3 Series High Dielectric Constant Type

p00 ← Part Number List EIA: X7T

LxW (mm)	6.1x5.3														
	3.0			3.9			5.0		6.7						
T max. (mm)	630			450			250		630			450		250	
Rated Voltage (Vdc)	630	450	250	630	450	250	450	250	630	450	250	630	450	250	
Cap. / TC Code	X7T	X7T	X7T	X7T	X7T	X7T	X7T	X7T	X7T	X7T	X7T	X7T	X7T	X7T	
0.10μF	p45														
0.15μF	p45														
0.22μF		p45		p45											
0.27μF			p45												
0.33μF		p45													
0.47μF		p45	p45							p45					
0.56μF				p45						p45					
0.68μF			p45								p45				
1.0μF					p45	p45									
1.2μF													p45		
1.5μF										p45					
2.2μF														p45	

Search Capacitors

Specifications and Test Methods, Package, Chart of Characteristic Data, please refer to the search web page.
<http://www.murata.com/products/capacitor/>



Data Sheet

The product details page can be output in PDF.

Status and Features Icons

The status and features of products can be checked at once. When ? is clicked, a description of each icon will be displayed.

Characteristics & Applications

This links to the introduction page of each series.

Detailed Specifications Sheet

- Rated value
- Specifications and Test Methods
- Package
- Caution, Notice (Storage, Soldering and Mounting,etc.)

Characteristics Data

The following characteristics data of the main products can be acquired.

- SPICE Netlist (mod type)
- S parameter (S2P type)
- Reliability Test Data *Typical data

- Shape (Dimensions)
- Rated Values

- Specification by Packaging Code/ Minimum Order Quantity
- Weight (1 pc/ø180mm reel)

Chart of Characteristic Data

The main products published characteristic data.

- Frequency characteristics (ESR, Impedance)
- S parameter (Smith chart S11)
- DC bias characteristics
- AC voltage characteristics
- Capacitance - temperature characteristics
- Calorific property by ripple current

Design Tools SimSurfing

The SimSurfing design tools are useful for displaying the graph, downloading CSV data and overwriting the product number graph.

General Purpose Product

GCM Series



Capacitor for automotive applications such as power train and safety equipment.

Features

1 Ideal for power trains and safety devices in automobiles.

This product can be used for safety devices, such as the drive system control for engine ECU, air bags, and ABS. This product has cleared test conditions more severe than that of general products (GRM Series) even in temperature cycle and humidity load tests.

	General Purpose GRM Series Maximum operating temperature: 85°C/105°C/125°C	GCM Series for Automobiles Maximum operating temperature: 125°C
Items	Test Method	Test Method
Temperature Cycle	Temperature Cycle: 5 cycles	Temperature Cycle: 100 cycles (1,000 cycles for AEC-Q200 conforming products)
Humidity Loading	Test temperature: 40±2°C Test humidity: 90 to 95%RH Test time: 500 hours	Test temperature: 85±2°C Test humidity: 80 to 85%RH Test time: 500 hours (1,000 hours for AEC-Q200 conforming products)

2 Can be used at 125°C and 150°C temperatures.

We also offer a lineup for 150°C that can be used in the engine room.

3 Sn plating is applied to the external electrodes; excellent solder ability.

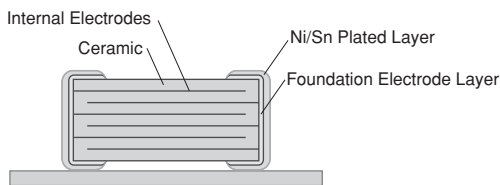

<Example of Structure>

Specifications

Size	0.6×0.3mm to 5.7×5.0mm
Rated Voltage	6.3Vdc to 1kVdc
Capacitance	0.1pF to 47μF
Main Applications	Drive system control of engine ECU, Airbag, Safety equipment such as ABS

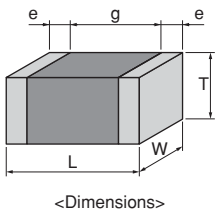

GCM Series Temperature Compensating Type AEC Q200 Part Number List

■ 0.6×0.3mm Ultra-compact

T max.	Rated Voltage	TC Code	Cap.	Tol.	Part Number
0.33mm	25Vdc	COG	1.0pF	±0.25pF	GCM0335C1E1R0CD03#
			2.0pF	±0.25pF	GCM0335C1E2R0CD03#
			3.0pF	±0.25pF	GCM0335C1E3R0CD03#
			4.0pF	±0.25pF	GCM0335C1E4R0CD03#
			5.0pF	±0.25pF	GCM0335C1E5R0CD03#
			6.0pF	±0.5pF	GCM0335C1E6R0DD03#
			7.0pF	±0.5pF	GCM0335C1E7R0DD03#
			8.0pF	±0.5pF	GCM0335C1E8R0DD03#
			9.0pF	±0.5pF	GCM0335C1E9R0DD03#
			10pF	±5%	GCM0335C1E100JD03#
			12pF	±5%	GCM0335C1E120JD03#
			15pF	±5%	GCM0335C1E150JD03#
			18pF	±5%	GCM0335C1E180JD03#
			22pF	±5%	GCM0335C1E220JD03#
			27pF	±5%	GCM0335C1E270JD03#
			33pF	±5%	GCM0335C1E330JD03#
			39pF	±5%	GCM0335C1E390JD03#
			47pF	±5%	GCM0335C1E470JD03#
			56pF	±5%	GCM0335C1E560JD03#
			68pF	±5%	GCM0335C1E680JD03#
82pF	±5%	GCM0335C1E820JD03#			
100pF	±5%	GCM0335C1E101JD03#			

■ 1.0×0.5mm

T max.	Rated Voltage	TC Code	Cap.	Tol.	Part Number
0.55mm	50Vdc	COG	1.0pF	±0.25pF	GCM1555C1H1R0CA16#
			2.0pF	±0.25pF	GCM1555C1H2R0CA16#
			3.0pF	±0.25pF	GCM1555C1H3R0CA16#
			4.0pF	±0.25pF	GCM1555C1H4R0CA16#
			5.0pF	±0.25pF	GCM1555C1H5R0CA16#
			6.0pF	±0.5pF	GCM1555C1H6R0DA16#
			7.0pF	±0.5pF	GCM1555C1H7R0DA16#
			8.0pF	±0.5pF	GCM1555C1H8R0DA16#
			9.0pF	±0.5pF	GCM1555C1H9R0DA16#
			10pF	±5%	GCM1555C1H100JA16#
			12pF	±5%	GCM1555C1H120JA16#
			15pF	±5%	GCM1555C1H150JA16#
			18pF	±5%	GCM1555C1H180JA16#
			22pF	±5%	GCM1555C1H220JA16#
			27pF	±5%	GCM1555C1H270JA16#
			33pF	±5%	GCM1555C1H330JA16#
			39pF	±5%	GCM1555C1H390JA16#
			47pF	±5%	GCM1555C1H470JA16#
			56pF	±5%	GCM1555C1H560JA16#
			68pF	±5%	GCM1555C1H680JA16#
82pF	±5%	GCM1555C1H820JA16#			
100pF	±5%	GCM1555C1H101JA16#			
120pF	±5%	GCM1555C1H121JA16#			
150pF	±5%	GCM1555C1H151JA16#			
180pF	±5%	GCM1555C1H181JA16#			

T max.	Rated Voltage	TC Code	Cap.	Tol.	Part Number
0.55mm	50Vdc	COG	220pF	±5%	GCM1555C1H221JA16#
			270pF	±5%	GCM1555C1H271JA16#
			330pF	±5%	GCM1555C1H331JA16#
			390pF	±5%	GCM1555C1H391JA16#
			470pF	±5%	GCM1555C1H471JA16#

■ 1.6×0.8mm

T max.	Rated Voltage	TC Code	Cap.	Tol.	Part Number
0.9mm	100Vdc	COG	1.0pF	±0.25pF	GCM1885C2A1R0CA16#
			2.0pF	±0.25pF	GCM1885C2A2R0CA16#
			3.0pF	±0.25pF	GCM1885C2A3R0CA16#
			4.0pF	±0.25pF	GCM1885C2A4R0CA16#
			5.0pF	±0.25pF	GCM1885C2A5R0CA16#
			6.0pF	±0.5pF	GCM1885C2A6R0DA16#
			7.0pF	±0.5pF	GCM1885C2A7R0DA16#
			8.0pF	±0.5pF	GCM1885C2A8R0DA16#
			9.0pF	±0.5pF	GCM1885C2A9R0DA16#
			10pF	±5%	GCM1885C2A100JA16#
			12pF	±5%	GCM1885C2A120JA16#
			15pF	±5%	GCM1885C2A150JA16#
			18pF	±5%	GCM1885C2A180JA16#
			22pF	±5%	GCM1885C2A220JA16#
			27pF	±5%	GCM1885C2A270JA16#
			33pF	±5%	GCM1885C2A330JA16#
			39pF	±5%	GCM1885C2A390JA16#
			47pF	±5%	GCM1885C2A470JA16#
			56pF	±5%	GCM1885C2A560JA16#
			68pF	±5%	GCM1885C2A680JA16#
			82pF	±5%	GCM1885C2A820JA16#
			100pF	±5%	GCM1885C2A101JA16#
			120pF	±5%	GCM1885C2A121JA16#
			150pF	±5%	GCM1885C2A151JA16#
			180pF	±5%	GCM1885C2A181JA16#
			220pF	±5%	GCM1885C2A221JA16#
			270pF	±5%	GCM1885C2A271JA16#
			330pF	±5%	GCM1885C2A331JA16#
			390pF	±5%	GCM1885C2A391JA16#
			470pF	±5%	GCM1885C2A471JA16#
560pF	±5%	GCM1885C2A561JA16#			
680pF	±5%	GCM1885C2A681JA16#			
820pF	±5%	GCM1885C2A821JA16#			
1000pF	±5%	GCM1885C2A102JA16#			
1200pF	±5%	GCM1885C2A122JA16#			
1500pF	±5%	GCM1885C2A152JA16#			
	50Vdc	COG	1.0pF	±0.25pF	GCM1885C1H1R0CA16#
			2.0pF	±0.25pF	GCM1885C1H2R0CA16#
			3.0pF	±0.25pF	GCM1885C1H3R0CA16#
			4.0pF	±0.25pF	GCM1885C1H4R0CA16#
			5.0pF	±0.25pF	GCM1885C1H5R0CA16#
			6.0pF	±0.5pF	GCM1885C1H6R0DA16#
			7.0pF	±0.5pF	GCM1885C1H7R0DA16#
			8.0pF	±0.5pF	GCM1885C1H8R0DA16#

Part number # indicates the package specification code.

GCM Series Temperature Compensating Type AEC Q200 Part Number List

(→ ■ 1.6x0.8mm)

T max.	Rated Voltage	TC Code	Cap.	Tol.	Part Number
0.9mm	50Vdc	C0G	9.0pF	±0.5pF	GCM1885C1H9R0DA16#
			10pF	±5%	GCM1885C1H100JA16#
			12pF	±5%	GCM1885C1H120JA16#
			15pF	±5%	GCM1885C1H150JA16#
			18pF	±5%	GCM1885C1H180JA16#
			22pF	±5%	GCM1885C1H220JA16#
			27pF	±5%	GCM1885C1H270JA16#
			33pF	±5%	GCM1885C1H330JA16#
			39pF	±5%	GCM1885C1H390JA16#
			47pF	±5%	GCM1885C1H470JA16#
			56pF	±5%	GCM1885C1H560JA16#
			68pF	±5%	GCM1885C1H680JA16#
			82pF	±5%	GCM1885C1H820JA16#
			100pF	±5%	GCM1885C1H101JA16#
			120pF	±5%	GCM1885C1H121JA16#
			150pF	±5%	GCM1885C1H151JA16#
			180pF	±5%	GCM1885C1H181JA16#
			220pF	±5%	GCM1885C1H221JA16#
			270pF	±5%	GCM1885C1H271JA16#
			330pF	±5%	GCM1885C1H331JA16#
			390pF	±5%	GCM1885C1H391JA16#
			470pF	±5%	GCM1885C1H471JA16#
			560pF	±5%	GCM1885C1H561JA16#
			680pF	±5%	GCM1885C1H681JA16#
			820pF	±5%	GCM1885C1H821JA16#
			1000pF	±5%	GCM1885C1H102JA16#
			1200pF	±5%	GCM1885C1H122JA16#
			1500pF	±5%	GCM1885C1H152JA16#
			1800pF	±5%	GCM1885C1H182JA16#
			2200pF	±5%	GCM1885C1H222JA16#
			2700pF	±5%	GCM1885C1H272JA16#
			3300pF	±5%	GCM1885C1H332JA16#
			3900pF	±5%	GCM1885C1H392JA16#

■ 2.0x1.25mm

T max.	Rated Voltage	TC Code	Cap.	Tol.	Part Number
0.7mm	100Vdc	C0G	100pF	±5%	GCM2165C2A101JA16#
			120pF	±5%	GCM2165C2A121JA16#
			150pF	±5%	GCM2165C2A151JA16#
			180pF	±5%	GCM2165C2A181JA16#
			220pF	±5%	GCM2165C2A221JA16#
			270pF	±5%	GCM2165C2A271JA16#
			330pF	±5%	GCM2165C2A331JA16#
			390pF	±5%	GCM2165C2A391JA16#
			470pF	±5%	GCM2165C2A471JA16#
			560pF	±5%	GCM2165C2A561JA16#
			680pF	±5%	GCM2165C2A681JA16#
			820pF	±5%	GCM2165C2A821JA16#
			1000pF	±5%	GCM2165C2A102JA16#
			1200pF	±5%	GCM2165C2A122JA16#
			1500pF	±5%	GCM2165C2A152JA16#
			1800pF	±5%	GCM2165C2A182JA16#

T max.	Rated Voltage	TC Code	Cap.	Tol.	Part Number			
0.7mm	100Vdc	C0G	2200pF	±5%	GCM2165C2A222JA16#			
			2700pF	±5%	GCM2165C2A272JA16#			
			3300pF	±5%	GCM2165C2A332JA16#			
			50Vdc	C0G	1000pF	±5%	GCM2165C1H102JA16#	
					1200pF	±5%	GCM2165C1H122JA16#	
					1500pF	±5%	GCM2165C1H152JA16#	
					1800pF	±5%	GCM2165C1H182JA16#	
					2200pF	±5%	GCM2165C1H222JA16#	
					2700pF	±5%	GCM2165C1H272JA16#	
	0.95mm	100Vdc	ZLM	1000pF	±10%	GCM2199E2A102KA05#		
					±20%	GCM2199E2A102MA05#		
				1100pF	±10%	GCM2199E2A112KA05#		
					±20%	GCM2199E2A112MA05#		
				1200pF	±10%	GCM2199E2A122KA05#		
					±20%	GCM2199E2A122MA05#		
				1300pF	±10%	GCM2199E2A132KA05#		
					±20%	GCM2199E2A132MA05#		
				1500pF	±10%	GCM2199E2A152KA05#		
					±20%	GCM2199E2A152MA05#		
0.95mm	50Vdc	C0G	5600pF	±5%	GCM2195C1H562JA16#			
			6800pF	±5%	GCM2195C1H682JA16#			
			8200pF	±5%	GCM2195C1H822JA16#			
			10000pF	±5%	GCM2195C1H103JA16#			
			12000pF	±5%	GCM2195C1H123JA16#			
			15000pF	±5%	GCM2195C1H153JA16#			
			1.0mm	250Vdc	U2J	100pF	±5%	GCM21A7U2E101JX01#
						120pF	±5%	GCM21A7U2E121JX01#
						150pF	±5%	GCM21A7U2E151JX01#
						180pF	±5%	GCM21A7U2E181JX01#
220pF	±5%	GCM21A7U2E221JX01#						
270pF	±5%	GCM21A7U2E271JX01#						
330pF	±5%	GCM21A7U2E331JX01#						
390pF	±5%	GCM21A7U2E391JX01#						
470pF	±5%	GCM21A7U2E471JX01#						
560pF	±5%	GCM21A7U2E561JX01#						
680pF	±5%	GCM21A7U2E681JX01#						
820pF	±5%	GCM21A7U2E821JX01#						
1000pF	±5%	GCM21A7U2E102JX01#						
1200pF	±5%	GCM21A7U2E122JX01#						
1.4mm	50Vdc	C0G	18000pF	±5%	GCM21B5C1H183JA16#			
			22000pF	±5%	GCM21B5C1H223JA16#			
1.45mm	250Vdc	U2J	2700pF	±5%	GCM21B7U2E272JX03#			
			3300pF	±5%	GCM21B7U2E332JX03#			
			3900pF	±5%	GCM21B7U2E392JX03#			
			4700pF	±5%	GCM21B7U2E472JX03#			
			5600pF	±5%	GCM21B7U2E562JX03#			

Part number # indicates the package specification code.

GCM Series Temperature Compensating Type AEC Q200 Part Number List

■ 3.2x1.6mm

T max.	Rated Voltage	TC Code	Cap.	Tol.	Part Number		
0.95mm	100Vdc	C0G	1800pF	±5%	GCM3195C2A182JA16#		
			2200pF	±5%	GCM3195C2A222JA16#		
			2700pF	±5%	GCM3195C2A272JA16#		
			3300pF	±5%	GCM3195C2A332JA16#		
			3900pF	±5%	GCM3195C2A392JA16#		
			4700pF	±5%	GCM3195C2A472JA16#		
			5600pF	±5%	GCM3195C2A562JA16#		
			6800pF	±5%	GCM3195C2A682JA16#		
			8200pF	±5%	GCM3195C2A822JA16#		
			10000pF	±5%	GCM3195C2A103JA16#		
			80Vdc	C0G	33000pF	±5%	GCM3195C1K333JA16#
	63Vdc	C0G	33000pF	±5%	GCM3195C1J333JA16#		
	50Vdc	C0G	3900pF	±5%	GCM3195C1H392JA16#		
			4700pF	±5%	GCM3195C1H472JA16#		
			5600pF	±5%	GCM3195C1H562JA16#		
			6800pF	±5%	GCM3195C1H682JA16#		
			8200pF	±5%	GCM3195C1H822JA16#		
			10000pF	±5%	GCM3195C1H103JA16#		
			12000pF	±5%	GCM3195C1H123JA16#		
			15000pF	±5%	GCM3195C1H153JA16#		
			18000pF	±5%	GCM3195C1H183JA16#		
			22000pF	±5%	GCM3195C1H223JA16#		
			27000pF	±5%	GCM3195C1H273JA16#		
	33000pF	±5%	GCM3195C1H333JA16#				
	39000pF	±5%	GCM3195C1H393JA16#				
	1.0mm	1000Vdc	U2J	10pF	±5%	GCM31A7U3A100JX01#	
				12pF	±5%	GCM31A7U3A120JX01#	
				15pF	±5%	GCM31A7U3A150JX01#	
				18pF	±5%	GCM31A7U3A180JX01#	
				22pF	±5%	GCM31A7U3A220JX01#	
				27pF	±5%	GCM31A7U3A270JX01#	
				33pF	±5%	GCM31A7U3A330JX01#	
				39pF	±5%	GCM31A7U3A390JX01#	
47pF				±5%	GCM31A7U3A470JX01#		
56pF				±5%	GCM31A7U3A560JX01#		
68pF				±5%	GCM31A7U3A680JX01#		
82pF				±5%	GCM31A7U3A820JX01#		
100pF				±5%	GCM31A7U3A101JX01#		
120pF				±5%	GCM31A7U3A121JX01#		
150pF				±5%	GCM31A7U3A151JX01#		
180pF				±5%	GCM31A7U3A181JX01#		
220pF				±5%	GCM31A7U3A221JX01#		
270pF				±5%	GCM31A7U3A271JX01#		
330pF				±5%	GCM31A7U3A331JX01#		
630Vdc				U2J	10pF	±5%	GCM31A7U2J100JX01#
					12pF	±5%	GCM31A7U2J120JX01#
	15pF	±5%	GCM31A7U2J150JX01#				
	18pF	±5%	GCM31A7U2J180JX01#				
	22pF	±5%	GCM31A7U2J220JX01#				
	27pF	±5%	GCM31A7U2J270JX01#				
	33pF	±5%	GCM31A7U2J330JX01#				
	39pF	±5%	GCM31A7U2J390JX01#				

T max.	Rated Voltage	TC Code	Cap.	Tol.	Part Number	
1.0mm	630Vdc	U2J	47pF	±5%	GCM31A7U2J470JX01#	
			56pF	±5%	GCM31A7U2J560JX01#	
			68pF	±5%	GCM31A7U2J680JX01#	
			82pF	±5%	GCM31A7U2J820JX01#	
			100pF	±5%	GCM31A7U2J101JX01#	
			120pF	±5%	GCM31A7U2J121JX01#	
			150pF	±5%	GCM31A7U2J151JX01#	
			180pF	±5%	GCM31A7U2J181JX01#	
			220pF	±5%	GCM31A7U2J221JX01#	
			270pF	±5%	GCM31A7U2J271JX01#	
			330pF	±5%	GCM31A7U2J331JX01#	
			390pF	±5%	GCM31A7U2J391JX01#	
			470pF	±5%	GCM31A7U2J471JX01#	
			560pF	±5%	GCM31A7U2J561JX01#	
			680pF	±5%	GCM31A7U2J681JX01#	
			820pF	±5%	GCM31A7U2J821JX01#	
			1000pF	±5%	GCM31A7U2J102JX01#	
			1200pF	±5%	GCM31A7U2J122JX01#	
			1500pF	±5%	GCM31A7U2J152JX01#	
			1800pF	±5%	GCM31A7U2J182JX01#	
			2200pF	±5%	GCM31A7U2J222JX01#	
	250Vdc	U2J	2700pF	±5%	GCM31A7U2E272JX01#	
	3300pF		±5%	GCM31A7U2E332JX01#		
	3900pF		±5%	GCM31A7U2E392JX01#		
	4700pF		±5%	GCM31A7U2E472JX01#		
	5600pF		±5%	GCM31A7U2E562JX01#		
	630Vdc		U2J	390pF	±5%	GCM31B7U3A391JX01#
	470pF	±5%		GCM31B7U3A471JX01#		
	560pF	±5%		GCM31B7U3A561JX01#		
	680pF	±5%		GCM31B7U3A681JX01#		
	1.25mm	1000Vdc	U2J	2700pF	±5%	GCM31B7U2J272JX01#
				3300pF	±5%	GCM31B7U2J332JX01#
				3900pF	±5%	GCM31B7U2E682JX01#
4700pF				±5%	GCM31B7U2E822JX01#	
630Vdc		U2J	10000pF	±5%	GCM31B7U2E103JX01#	
			56000pF	±5%	GCM31M5C1H563JA16#	
1.8mm	1000Vdc	U2J	47000pF	±5%	GCM31M5C1H473JA16#	
			56000pF	±5%	GCM31M5C1H563JA16#	
			820pF	±5%	GCM31C7U3A821JX03#	
	630Vdc	U2J	1000pF	±5%	GCM31C7U3A102JX03#	
			3900pF	±5%	GCM31C7U2J392JX03#	
			4700pF	±5%	GCM31C7U2J472JX03#	

■ 3.2x2.5mm

T max.	Rated Voltage	TC Code	Cap.	Tol.	Part Number
1.0mm	630Vdc	U2J	1200pF	±5%	GCM32A7U2J122JX01#
			1500pF	±5%	GCM32A7U2J152JX01#
			1800pF	±5%	GCM32A7U2J182JX01#
			2200pF	±5%	GCM32A7U2J222JX01#
			1.25mm	1000Vdc	U2J
630Vdc	U2J	5600pF	±5%	GCM32B7U2J562JX01#	
1.5mm	1000Vdc	U2J	1500pF	±5%	GCM32Q7U3A152JX01#
	630Vdc	U2J	6800pF	±5%	GCM32Q7U2J682JX01#

Part number # indicates the package specification code.

GCM Series Temperature Compensating Type AEC Q200 Part Number List

(→ ■ 3.2×2.5mm)

T max.	Rated Voltage	TC Code	Cap.	Tol.	Part Number
2.0mm	1000Vdc	U2J	1800pF	±5%	GCM32D7U3A182JX01#
			2200pF	±5%	GCM32D7U3A222JX01#
	630Vdc	U2J	8200pF	±5%	GCM32D7U2J822JX01#
			10000pF	±5%	GCM32D7U2J103JX01#

■ 4.5×3.2mm

T max.	Rated Voltage	TC Code	Cap.	Tol.	Part Number
1.5mm	1000Vdc	U2J	2700pF	±5%	GCM43Q7U3A272JX01#
			3300pF	±5%	GCM43Q7U3A332JX01#
	630Vdc	U2J	12000pF	±5%	GCM43Q7U2J123JX01#
2.0mm	1000Vdc	U2J	3900pF	±5%	GCM43D7U3A392JX01#
			4700pF	±5%	GCM43D7U3A472JX01#
	630Vdc	U2J	15000pF	±5%	GCM43D7U2J153JX01#
			18000pF	±5%	GCM43D7U2J183JX01#
			22000pF	±5%	GCM43D7U2J223JX01#

■ 5.7×5.0mm

T max.	Rated Voltage	TC Code	Cap.	Tol.	Part Number
1.5mm	1000Vdc	U2J	5600pF	±5%	GCM55Q7U3A562JX01#
			6800pF	±5%	GCM55Q7U3A682JX01#
	630Vdc	U2J	27000pF	±5%	GCM55Q7U2J273JX01#
2.0mm	1000Vdc	U2J	8200pF	±5%	GCM55D7U3A822JX01#
			10000pF	±5%	GCM55D7U3A103JX01#
	630Vdc	U2J	33000pF	±5%	GCM55D7U2J333JX01#
			39000pF	±5%	GCM55D7U2J393JX01#
			47000pF	±5%	GCM55D7U2J473JX01#

GCM Series

GCD Series

GCE Series

GCG Series

GCJ Series

GC3 Series

KCM Series

KC3 Series

⚠Caution/Notice

GCM Series High Dielectric Constant Type AEC Q200 Part Number List

■ 0.6×0.3mm Ultra-compact

T max.	Rated Voltage	TC Code	Cap.	Tol.	Part Number
0.33mm	25Vdc	X7R	100pF	±10%	GCM033R71E101KA03#
			150pF	±10%	GCM033R71E151KA03#
			220pF	±10%	GCM033R71E221KA03#
			330pF	±10%	GCM033R71E331KA03#
			470pF	±10%	GCM033R71E471KA03#
			680pF	±10%	GCM033R71E681KA03#
			1000pF	±10%	GCM033R71E102KA03#
			1500pF	±10%	GCM033R71E152KA03#
	16Vdc	X7R	2200pF	±10%	GCM033R71C222KA55#
			3300pF	±10%	GCM033R71C332KA55#
	10Vdc	X7R	4700pF	±10%	GCM033R71A472KA03#
			6800pF	±10%	GCM033R71A682KA03#
			10000pF	±10%	GCM033R71A103KA03#

■ 1.0×0.5mm

T max.	Rated Voltage	TC Code	Cap.	Tol.	Part Number		
0.55mm	100Vdc	X7R	220pF	±10%	GCM155R72A221KA37#		
			330pF	±10%	GCM155R72A331KA37#		
			470pF	±10%	GCM155R72A471KA37#		
			680pF	±10%	GCM155R72A681KA37#		
			1000pF	±10%	GCM155R72A102KA37#		
			1500pF	±10%	GCM155R72A152KA37#		
			2200pF	±10%	GCM155R72A222KA37#		
			3300pF	±10%	GCM155R72A332KA37#		
			4700pF	±10%	GCM155R72A472KA37#		
			50Vdc	X7R	220pF	±10%	GCM155R71H221KA37#
					330pF	±10%	GCM155R71H331KA37#
					470pF	±10%	GCM155R71H471KA37#
					680pF	±10%	GCM155R71H681KA37#
					1000pF	±10%	GCM155R71H102KA37#
					1500pF	±10%	GCM155R71H152KA37#
					2200pF	±10%	GCM155R71H222KA37#
	3300pF	±10%			GCM155R71H332KA37#		
	4700pF	±10%			GCM155R71H472KA37#		
	6800pF	±10%			GCM155R71H682KA55#		
	10000pF	±10%			GCM155R71H103KA55#		
	15000pF	±10%			GCM155R71H153KA55#		
	22000pF	±10%			GCM155R71H223KA55#		
	33000pF	±10%			GCM155R71H333KE02#		
	47000pF	±10%			GCM155R71H473KE02#		
	68000pF	±10%			GCM155R71H683KE02#		
	0.10μF	±10%			GCM155R71H104KE02#		
	25Vdc	X7R			10000pF	±10%	GCM155R71E103KA37#
					15000pF	±10%	GCM155R71E153KA55#
					22000pF	±10%	GCM155R71E223KA55#
			33000pF	±10%	GCM155R71E333KA55#		
			47000pF	±10%	GCM155R71E473KA55#		
			16Vdc	X7R	33000pF	±10%	GCM155R71C333KA37#
					47000pF	±10%	GCM155R71C473KA37#
					68000pF	±10%	GCM155R71C683KA55#
	0.10μF	±10%			GCM155R71C104KE02#		

T max.	Rated Voltage	TC Code	Cap.	Tol.	Part Number
0.55mm	16Vdc	X7R	0.10μF	±10%	GCM155R71C104KA55#
			0.15μF	±10%	GCM155R71C154KE02#
			0.22μF	±10%	GCM155R71C224KE02#

■ 1.6×0.8mm

T max.	Rated Voltage	TC Code	Cap.	Tol.	Part Number		
0.9mm	100Vdc	X7R	1000pF	±10%	GCM188R72A102KA37#		
			1500pF	±10%	GCM188R72A152KA37#		
			2200pF	±10%	GCM188R72A222KA37#		
			3300pF	±10%	GCM188R72A332KA37#		
			4700pF	±10%	GCM188R72A472KA37#		
			6800pF	±10%	GCM188R72A682KA37#		
			10000pF	±10%	GCM188R72A103KA37#		
			15000pF	±10%	GCM188R72A153KA37#		
			22000pF	±10%	GCM188R72A223KA37#		
			50Vdc	X7R	1000pF	±10%	GCM188R71H102KA37#
					1500pF	±10%	GCM188R71H152KA37#
					2200pF	±10%	GCM188R71H222KA37#
					3300pF	±10%	GCM188R71H332KA37#
					4700pF	±10%	GCM188R71H472KA37#
					6800pF	±10%	GCM188R71H682KA37#
					10000pF	±10%	GCM188R71H103KA37#
	15000pF	±10%			GCM188R71H153KA37#		
	22000pF	±10%			GCM188R71H223KA37#		
	33000pF	±10%			GCM188R71H333KA55#		
	47000pF	±10%			GCM188R71H473KA55#		
	68000pF	±10%			GCM188R71H683KA57#		
	0.10μF	±10%			GCM188R71H104KA57#		
	0.15μF	±10%			GCM188R71H154KA64#		
	0.22μF	±10%			GCM188R71H224KA64#		
	25Vdc	X7R			33000pF	±10%	GCM188R71E333KA37#
					47000pF	±10%	GCM188R71E473KA37#
					68000pF	±10%	GCM188R71E683KA57#
					0.10μF	±10%	GCM188R71E104KA57#
					0.15μF	±10%	GCM188R71E154KA37#
			0.22μF	±10%	GCM188R71E224KA55#		
			0.47μF	±10%	GCM188R71E474KA64#		
			1.0μF	±10%	GCM188R71E105KA64#		
	16Vdc	X7R	0.10μF	±10%	GCM188R71C104KA37#		
			0.33μF	±10%	GCM188R71C334KA37#		
			0.47μF	±10%	GCM188R71C474KA55#		
			1.0μF	±10%	GCM188R71C105KA64#		
6.3Vdc	X7R	2.2μF	±10%	GCM188R70J225KE22#			

■ 2.0×1.25mm

T max.	Rated Voltage	TC Code	Cap.	Tol.	Part Number
0.7mm	100Vdc	X7R	6800pF	±10%	GCM216R72A682KA37#
			10000pF	±10%	GCM216R72A103KA37#
			15000pF	±10%	GCM216R72A153KA37#
			22000pF	±10%	GCM216R72A223KA37#

Part number # indicates the package specification code.

GCM Series High Dielectric Constant Type AEC-Q200 Part Number List

(→ ■ 2.0x1.25mm)

T max.	Rated Voltage	TC Code	Cap.	Tol.	Part Number	
0.95mm	100Vdc	X7R	33000pF	±10%	GCM219R72A333KA37#	
	50Vdc	X7R	33000pF	±10%	GCM219R71H333KA37#	
			0.33μF	±10%	GCM219R71H334KA55#	
	25Vdc	X7R	0.47μF	±10%	GCM219R71E474KA55#	
	16Vdc	X7R	0.68μF	±10%	GCM219R71C684KA37#	
1.0μF			±10%	GCM219R71C105KA37#		
1.4mm	100Vdc	X7R	47000pF	±10%	GCM21BR72A473KA37#	
			68000pF	±10%	GCM21BR72A683KA37#	
			0.10μF	±10%	GCM21BR72A104KA37#	
		50Vdc	X7R	47000pF	±10%	GCM21BR71H473KA37#
				68000pF	±10%	GCM21BR71H683KA37#
				0.10μF	±10%	GCM21BR71H104KA37#
	35Vdc		X7R	0.15μF	±10%	GCM21BR71H154KA37#
				0.22μF	±10%	GCM21BR71H224KA37#
				0.47μF	±10%	GCM21BR71H474KA55#
		25Vdc	X7R	1.0μF	±10%	GCM21BR71H105KA03#
				0.68μF	±10%	GCM21BR7YA684KA55#
				1.0μF	±10%	GCM21BR7YA105KA55#
	16Vdc	X7R	1.5μF	±10%	GCM21BR7YA155KA54#	
			0.15μF	±10%	GCM21BR71E154KA37#	
			0.22μF	±10%	GCM21BR71E224KA37#	
		10Vdc	X7R	0.33μF	±10%	GCM21BR71E334KA37#
				0.68μF	±10%	GCM21BR71E684KA55#
				1.0μF	±10%	GCM21BR71E105KA56#
		6.3Vdc	X7R	2.2μF	±10%	GCM21BR71E225KA73#
				4.7μF	±10%	GCM21BR71C225KA64#
				4.7μF	±10%	GCM21BR71C475KA73#
	10Vdc	X7R	2.2μF	±10%	GCM21BR71A225KA37#	
			10μF	±10%	GCM21BR71A106KE22#	
		X7S	4.7μF	±10%	GCM21BC71A475KA73#	
	6.3Vdc	X7R	10μF	±10%	GCM21BR70J106KE22#	

■ 3.2x2.5mm

T max.	Rated Voltage	TC Code	Cap.	Tol.	Part Number
2.2mm	25Vdc	X7R	4.7μF	±10%	GCM32DR71E475KA55#
	16Vdc	X7R	10μF	±10%	GCM32DR71C106KA37#
2.7mm	50Vdc	X7R	1.0μF	±10%	GCM32ER71H105KA37#
			4.7μF	±10%	GCM32ER71H475KA55#
	35Vdc	X7S	10μF	±10%	GCM32EC71H106KA03#
			10μF	±10%	GCM32EC7YA106KA03#
	25Vdc	X7R	10μF	±10%	GCM32ER71E106KA57#
	16Vdc	X7R	22μF	±20%	GCM32ER71C226ME19#
10Vdc	X7R	22μF	±20%	GCM32ER71A226ME12#	
6.3Vdc	X7R	47μF	±20%	GCM32ER70J476ME19#	

■ 3.2x1.6mm

T max.	Rated Voltage	TC Code	Cap.	Tol.	Part Number
0.95mm	100Vdc	X7R	0.10μF	±10%	GCM319R72A104KA37#
1.25mm	100Vdc	X7R	0.15μF	±10%	GCM31MR72A154KA37#
			0.22μF	±10%	GCM31MR72A224KA37#
	50Vdc	X7R	0.33μF	±10%	GCM31MR71H334KA37#
			0.47μF	±10%	GCM31MR71H474KA37#
			0.68μF	±10%	GCM31MR71H684KA55#
1.0μF	±10%	GCM31MR71H105KA55#			
1.3mm	25Vdc	X7R	2.2μF	±10%	GCM31MR71E225KA57#
1.8mm	100Vdc	X7R	1.0μF	±10%	GCM31CR72A105KA03#
			2.2μF	±10%	GCM31CR71H225KA55#
	50Vdc	X7R	4.7μF	±10%	GCM31CC71H475KA03#
			X7S	4.7μF	±10%
	25Vdc	X7R	4.7μF	±10%	GCM31CR71E475KA55#
	16Vdc	X7R	4.7μF	±10%	GCM31CR71C475KA37#
			10μF	±10%	GCM31CR71C106KA64#
	10Vdc	X7R	10μF	±10%	GCM31CR71A106KA64#
22μF			±10%	GCM31CR71A226KE02#	
6.3Vdc	X7R	22μF	±20%	GCM31CR70J226ME23#	
1.9mm	25Vdc	X7S	10μF	±10%	GCM31CC71E106KA03#

Part number # indicates the package specification code.

Specially Designed Product to Reduce Shorts

GCD Series



AEC-Q200

Fail safe

Deflecting crack

Prevents momentary dielectric breakdown by a two-element array structure!

Features

① Prevents momentary dielectric breakdown by a two-element array structure!

This product consists of two elements arranged in one capacitor. It is structured so that even when one element is shorted, the other capacitor element will not short.

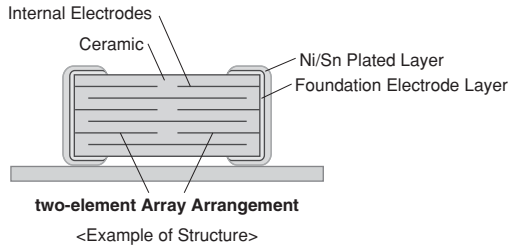

② This AEC-Q200 conforming product is ideal for battery lines of automobiles.

Space can be reduced in battery lines where two capacitors are arranged in an array.

Specifications

Size	1.6x0.8mm to 2.0x1.25mm
Rated Voltage	25Vdc to 100Vdc
Capacitance	1,000pF to 0.1μF
Main Applications	Battery lines and power trains for automobiles

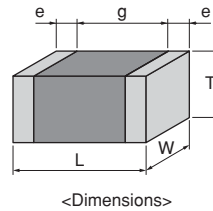

GCM Series

GCD Series

GCE Series

GCG Series

GCM Series

GCM Series

KCM Series

KC3 Series

⚠Caution/Notice

GCD Series High Dielectric Constant Type AEC-Q200 Fail safe Deflecting crack Part Number List

■ 1.6x0.8mm

T max.	Rated Voltage	TC Code	Cap.	Tol.	Part Number
0.9mm	100Vdc	X7R	1000pF	±10%	GCD188R72A102KA01#
			1200pF	±10%	GCD188R72A122KA01#
			1500pF	±10%	GCD188R72A152KA01#
			1800pF	±10%	GCD188R72A182KA01#
			2200pF	±10%	GCD188R72A222KA01#
			2700pF	±10%	GCD188R72A272KA01#
			3300pF	±10%	GCD188R72A332KA01#
			3900pF	±10%	GCD188R72A392KA01#
			4700pF	±10%	GCD188R72A472KA01#
			5600pF	±10%	GCD188R72A562KA01#
			6800pF	±10%	GCD188R72A682KA01#
			8200pF	±10%	GCD188R72A822KA01#
			10000pF	±10%	GCD188R72A103KA01#
			12000pF	±10%	GCD188R72A123KA01#
			15000pF	±10%	GCD188R72A153KA01#
			18000pF	±10%	GCD188R72A183KA01#
			22000pF	±10%	GCD188R72A223KA01#
			50Vdc	X7R	1000pF
	1200pF	±10%			GCD188R71H122KA01#
	1500pF	±10%			GCD188R71H152KA01#
	1800pF	±10%			GCD188R71H182KA01#
	2200pF	±10%			GCD188R71H222KA01#
	2700pF	±10%			GCD188R71H272KA01#
	3300pF	±10%			GCD188R71H332KA01#
	3900pF	±10%			GCD188R71H392KA01#
	4700pF	±10%			GCD188R71H472KA01#
	5600pF	±10%			GCD188R71H562KA01#
	25Vdc	X7R	2700pF	±10%	GCD188R71E273KA01#
3300pF			±10%	GCD188R71E333KA01#	
3900pF			±10%	GCD188R71E393KA01#	
4700pF			±10%	GCD188R71E473KA01#	

T max.	Rated Voltage	TC Code	Cap.	Tol.	Part Number			
0.7mm	100Vdc	X7R	5600pF	±10%	GCD216R72A562KA01#			
			1000pF	±10%	GCD216R71H102KA01#			
			1200pF	±10%	GCD216R71H122KA01#			
			1500pF	±10%	GCD216R71H152KA01#			
			1800pF	±10%	GCD216R71H182KA01#			
			2200pF	±10%	GCD216R71H222KA01#			
	50Vdc	X7R	2700pF	±10%	GCD216R71H272KA01#			
			3300pF	±10%	GCD216R71H332KA01#			
			3900pF	±10%	GCD216R71H392KA01#			
			4700pF	±10%	GCD216R71H472KA01#			
			5600pF	±10%	GCD216R71H562KA01#			
			0.95mm	100Vdc	X7R	6800pF	±10%	GCD219R72A682KA01#
1.4mm	100Vdc	X7R				8200pF	±10%	GCD21BR72A822KA01#
						10000pF	±10%	GCD21BR72A103KA01#
						12000pF	±10%	GCD21BR72A123KA01#
						15000pF	±10%	GCD21BR72A153KA01#
						18000pF	±10%	GCD21BR72A183KA01#
				22000pF	±10%	GCD21BR72A223KA01#		
50Vdc	X7R	27000pF		±10%	GCD21BR72A273KA01#			
		33000pF		±10%	GCD21BR72A333KA01#			
		39000pF		±10%	GCD21BR72A393KA01#			
		47000pF		±10%	GCD21BR72A473KA01#			
		56000pF		±10%	GCD21BR72A563KA01#			
		68000pF	±10%	GCD21BR72A683KA01#				
		82000pF	±10%	GCD21BR72A823KA01#				
		0.10μF	±10%	GCD21BR72A104KA01#				
		15000pF	±10%	GCD21BR71H153KA01#				
		18000pF	±10%	GCD21BR71H183KA01#				
		22000pF	±10%	GCD21BR71H223KA01#				
		27000pF	±10%	GCD21BR71H273KA01#				
33000pF	±10%	GCD21BR71H333KA01#						
39000pF	±10%	GCD21BR71H393KA01#						
47000pF	±10%	GCD21BR71H473KA01#						
56000pF	±10%	GCD21BR71H563KA01#						
68000pF	±10%	GCD21BR71H683KA01#						
82000pF	±10%	GCD21BR71H823KA01#						
0.10μF	±10%	GCD21BR71H104KA01#						

■ 2.0x1.25mm

T max.	Rated Voltage	TC Code	Cap.	Tol.	Part Number
0.7mm	100Vdc	X7R	1000pF	±10%	GCD216R72A102KA01#
			1200pF	±10%	GCD216R72A122KA01#
			1500pF	±10%	GCD216R72A152KA01#
			1800pF	±10%	GCD216R72A182KA01#
			2200pF	±10%	GCD216R72A222KA01#
			2700pF	±10%	GCD216R72A272KA01#
			3300pF	±10%	GCD216R72A332KA01#
			3900pF	±10%	GCD216R72A392KA01#
			4700pF	±10%	GCD216R72A472KA01#

Part number # indicates the package specification code.

GCM Series
 GCD Series
 GCE Series
 GCG Series
 GCJ Series
 GC3 Series
 KCM Series
 KC3 Series
 ⚠Caution/Notice

Specially Designed Product to Reduce Shorts & Resin Electrode Product

GCE Series



Further improved safety performance with a combination of a two-element array structure & resin external electrodes!

Features

① **Avoid instantaneous dielectric breakdown with the two-element array structure.**

This product is configured with two elements arranged in one capacitor. Even if one element short circuits, the other element in the capacitor does not short.

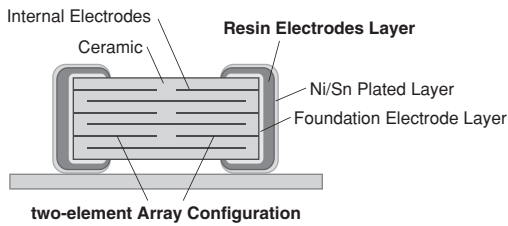

② **Provides additional safety performance in combination with resin electrodes.**

Adopting resin electrodes as the external electrodes will suppress the occurrence of cracking in the capacitor by mechanical stress.

● For Automobiles (GCM Series)

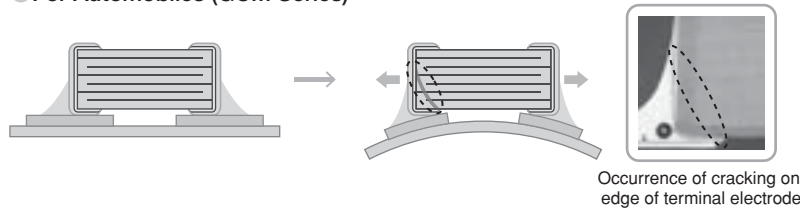

● Fail Safe Type (GCE Series)

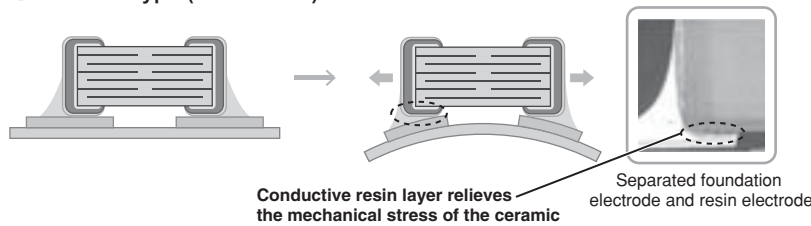

③ **Ideal for battery lines of on-board applications.**

Space can be reduced for battery lines, when two capacitors are configured in an array.

Specifications

Size	1.6×0.8mm to 2.0×1.25mm
Rated Voltage	50Vdc to 100Vdc
Capacitance	1000pF to 0.1μF
Main Applications	For automotive, battery lines, power trains

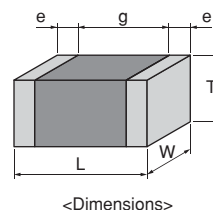

GCM Series

GCD Series

GCE Series

GCG Series

GCJ Series

GC3 Series

KCM Series

KC3 Series

⚠Caution/Notice

GCE Series High Dielectric Constant Type AEC-Q200 Fail safe Deflecting crack Part Number List

■ 1.6x0.8mm

T max.	Rated Voltage	TC Code	Cap.	Tol.	Part Number		
0.9mm	100Vdc	X7R	1000pF	±10%	GCE188R72A102KA01#		
			1200pF	±10%	GCE188R72A122KA01#		
			1500pF	±10%	GCE188R72A152KA01#		
			1800pF	±10%	GCE188R72A182KA01#		
			2200pF	±10%	GCE188R72A222KA01#		
			2700pF	±10%	GCE188R72A272KA01#		
			3300pF	±10%	GCE188R72A332KA01#		
			3900pF	±10%	GCE188R72A392KA01#		
			4700pF	±10%	GCE188R72A472KA01#		
			5600pF	±10%	GCE188R72A562KA01#		
			6800pF	±10%	GCE188R72A682KA01#		
			8200pF	±10%	GCE188R72A822KA01#		
			10000pF	±10%	GCE188R72A103KA01#		
			12000pF	±10%	GCE188R72A123KA01#		
			15000pF	±10%	GCE188R72A153KA01#		
			18000pF	±10%	GCE188R72A183KA01#		
			22000pF	±10%	GCE188R72A223KA01#		
			50Vdc	X7R	1000pF	±10%	GCE188R71H102KA01#
					1200pF	±10%	GCE188R71H122KA01#
					1500pF	±10%	GCE188R71H152KA01#
1800pF	±10%	GCE188R71H182KA01#					
2200pF	±10%	GCE188R71H222KA01#					
2700pF	±10%	GCE188R71H272KA01#					
3300pF	±10%	GCE188R71H332KA01#					
3900pF	±10%	GCE188R71H392KA01#					
4700pF	±10%	GCE188R71H472KA01#					
5600pF	±10%	GCE188R71H562KA01#					
6800pF	±10%	GCE188R71H682KA01#					
8200pF	±10%	GCE188R71H822KA01#					
10000pF	±10%	GCE188R71H103KA01#					
12000pF	±10%	GCE188R71H123KA01#					
15000pF	±10%	GCE188R71H153KA01#					
18000pF	±10%	GCE188R71H183KA01#					
22000pF	±10%	GCE188R71H223KA01#					

T max.	Rated Voltage	TC Code	Cap.	Tol.	Part Number		
0.7mm	50Vdc	X7R	1800pF	±10%	GCE216R71H182KA01#		
			2200pF	±10%	GCE216R71H222KA01#		
			2700pF	±10%	GCE216R71H272KA01#		
			3300pF	±10%	GCE216R71H332KA01#		
			3900pF	±10%	GCE216R71H392KA01#		
			4700pF	±10%	GCE216R71H472KA01#		
			5600pF	±10%	GCE216R71H562KA01#		
0.95mm	100Vdc	X7R	6800pF	±10%	GCE219R72A682KA01#		
1.45mm	100Vdc	X7R	8200pF	±10%	GCE21BR72A822KA01#		
			10000pF	±10%	GCE21BR72A103KA01#		
			12000pF	±10%	GCE21BR72A123KA01#		
			15000pF	±10%	GCE21BR72A153KA01#		
			18000pF	±10%	GCE21BR72A183KA01#		
			22000pF	±10%	GCE21BR72A223KA01#		
			27000pF	±10%	GCE21BR72A273KA01#		
			33000pF	±10%	GCE21BR72A333KA01#		
			39000pF	±10%	GCE21BR72A393KA01#		
			47000pF	±10%	GCE21BR72A473KA01#		
			56000pF	±10%	GCE21BR72A563KA01#		
			68000pF	±10%	GCE21BR72A683KA01#		
			82000pF	±10%	GCE21BR72A823KA01#		
			0.10μF	±10%	GCE21BR72A104KA01#		
			50Vdc	X7R	15000pF	±10%	GCE21BR71H153KA01#
					18000pF	±10%	GCE21BR71H183KA01#
					22000pF	±10%	GCE21BR71H223KA01#
					27000pF	±10%	GCE21BR71H273KA01#
					33000pF	±10%	GCE21BR71H333KA01#
					39000pF	±10%	GCE21BR71H393KA01#
47000pF	±10%	GCE21BR71H473KA01#					
56000pF	±10%	GCE21BR71H563KA01#					
68000pF	±10%	GCE21BR71H683KA01#					
82000pF	±10%	GCE21BR71H823KA01#					
0.10μF	±10%	GCE21BR71H104KA01#					

■ 2.0x1.25mm

T max.	Rated Voltage	TC Code	Cap.	Tol.	Part Number		
0.7mm	100Vdc	X7R	1000pF	±10%	GCE216R72A102KA01#		
			1200pF	±10%	GCE216R72A122KA01#		
			1500pF	±10%	GCE216R72A152KA01#		
			1800pF	±10%	GCE216R72A182KA01#		
			2200pF	±10%	GCE216R72A222KA01#		
			2700pF	±10%	GCE216R72A272KA01#		
			3300pF	±10%	GCE216R72A332KA01#		
			3900pF	±10%	GCE216R72A392KA01#		
			4700pF	±10%	GCE216R72A472KA01#		
			5600pF	±10%	GCE216R72A562KA01#		
			50Vdc	X7R	1000pF	±10%	GCE216R71H102KA01#
					1200pF	±10%	GCE216R71H122KA01#
					1500pF	±10%	GCE216R71H152KA01#

Part number # indicates the package specification code.

GCM Series
 GCD Series
GCE Series
 GCG Series
 GCJ Series
 GC3 Series
 KCM Series
 KC3 Series
 ⚠Caution/Notice

Conductivity Adhesive Compatible Type

GCG Series



AEC-Q200

Deflecting crack

Soldering crack

Improved mechanical and thermal strength by adopting AgPd external electrodes, which can be mounted with a conductive adhesive!

Features

① **Conductive adhesives can be used.**

This capacitor can be mounted with a conductive adhesive* in power trains and safety devices of automobiles.

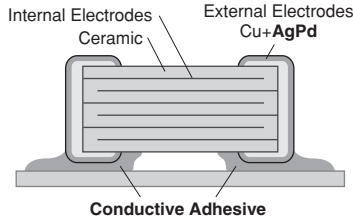

② **Adopted AgPd external electrodes.**

Adopted AgPd, which is excellent in bonding strength with a conductive adhesive.

③ **Compatible up to 150 °C.**

This capacitor lineup with X8L and X8R characteristics can be used in high-temperature environments, such as in ABS and transmission control.

* The conductive adhesive buffers the expansion and contraction difference between the substrate and parts caused by temperature changes, and has a high temperature cycle life span.

Specifications

Size	1.0x0.5mm to 3.2x2.5mm
Rated Voltage	16Vdc to 100Vdc
Capacitance	10pF to 10μF
Main Applications	For automotive, power trains, sensors

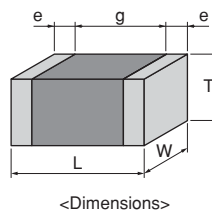

GCM Series

GCD Series

GCE Series

GCG Series

G CJ Series

G C3 Series

KCM Series

KC3 Series

⚠Caution/Notice

GCG Series Temperature Compensating Type AEC-Q200 Deflecting crack Soldering crack Part Number List

■ 1.0x0.5mm

T max.	Rated Voltage	TC Code	Cap.	Tol.	Part Number
0.55mm	50Vdc	X8G	120pF	±5%	GCG1555G1H121JA01#
			150pF	±5%	GCG1555G1H151JA01#
			180pF	±5%	GCG1555G1H181JA01#
			220pF	±5%	GCG1555G1H221JA01#
			270pF	±5%	GCG1555G1H271JA01#
			330pF	±5%	GCG1555G1H331JA01#
			390pF	±5%	GCG1555G1H391JA01#
			470pF	±5%	GCG1555G1H471JA01#

■ 1.6x0.8mm

T max.	Rated Voltage	TC Code	Cap.	Tol.	Part Number
0.9mm	50Vdc	X8G	10pF	±5%	GCG1885G1H100JA01#
			12pF	±5%	GCG1885G1H120JA01#
			15pF	±5%	GCG1885G1H150JA01#
			18pF	±5%	GCG1885G1H180JA01#
			22pF	±5%	GCG1885G1H220JA01#
			27pF	±5%	GCG1885G1H270JA01#
			33pF	±5%	GCG1885G1H330JA01#
			39pF	±5%	GCG1885G1H390JA01#
			47pF	±5%	GCG1885G1H470JA01#
			56pF	±5%	GCG1885G1H560JA01#
			68pF	±5%	GCG1885G1H680JA01#
			82pF	±5%	GCG1885G1H820JA01#
			100pF	±5%	GCG1885G1H101JA01#
			120pF	±5%	GCG1885G1H121JA01#
			150pF	±5%	GCG1885G1H151JA01#
			180pF	±5%	GCG1885G1H181JA01#
			220pF	±5%	GCG1885G1H221JA01#
			270pF	±5%	GCG1885G1H271JA01#
			330pF	±5%	GCG1885G1H331JA01#
			390pF	±5%	GCG1885G1H391JA01#
			470pF	±5%	GCG1885G1H471JA01#
			560pF	±5%	GCG1885G1H561JA01#
			680pF	±5%	GCG1885G1H681JA01#
			820pF	±5%	GCG1885G1H821JA01#
			1000pF	±5%	GCG1885G1H102JA01#
			1200pF	±5%	GCG1885G1H122JA01#
			1500pF	±5%	GCG1885G1H152JA01#
			1800pF	±5%	GCG1885G1H182JA01#
			2200pF	±5%	GCG1885G1H222JA01#

■ 2.0x1.25mm

T max.	Rated Voltage	TC Code	Cap.	Tol.	Part Number
0.7mm	50Vdc	X8G	100pF	±5%	GCG2165G1H101JA01#
			120pF	±5%	GCG2165G1H121JA01#
			150pF	±5%	GCG2165G1H151JA01#
			180pF	±5%	GCG2165G1H181JA01#
			220pF	±5%	GCG2165G1H221JA01#

T max.	Rated Voltage	TC Code	Cap.	Tol.	Part Number
0.7mm	50Vdc	X8G	270pF	±5%	GCG2165G1H271JA01#
			330pF	±5%	GCG2165G1H331JA01#
			390pF	±5%	GCG2165G1H391JA01#
			470pF	±5%	GCG2165G1H471JA01#
			560pF	±5%	GCG2165G1H561JA01#
			680pF	±5%	GCG2165G1H681JA01#
			820pF	±5%	GCG2165G1H821JA01#
			1000pF	±5%	GCG2165G1H102JA01#
			1200pF	±5%	GCG2165G1H122JA01#
			1500pF	±5%	GCG2165G1H152JA01#
			1800pF	±5%	GCG2165G1H182JA01#
			2200pF	±5%	GCG2165G1H222JA01#
			2700pF	±5%	GCG2165G1H272JA01#
			3300pF	±5%	GCG2165G1H332JA01#
			3900pF	±5%	GCG2165G1H392JA01#
			4700pF	±5%	GCG2165G1H472JA01#
			0.95mm	50Vdc	X8G
6800pF	±5%	GCG2195G1H682JA01#			
8200pF	±5%	GCG2195G1H822JA01#			
10000pF	±5%	GCG2195G1H103JA01#			

GCM Series

GCD Series

GCE Series

GCG Series

GCJ Series

GCG Series

KCM Series

KC3 Series

⚠Caution/Notice

Part number # indicates the package specification code.

GCG Series High Dielectric Constant Type AEC-Q200 Defecting crack Soldering crack Part Number List

■ 1.0x0.5mm

T max.	Rated Voltage	TC Code	Cap.	Tol.	Part Number		
0.55mm	50Vdc	X7R	220pF	±10%	GCG155R71H221KA01#		
			270pF	±10%	GCG155R71H271KA01#		
			330pF	±10%	GCG155R71H331KA01#		
			390pF	±10%	GCG155R71H391KA01#		
			470pF	±10%	GCG155R71H471KA01#		
			560pF	±10%	GCG155R71H561KA01#		
			680pF	±10%	GCG155R71H681KA01#		
			820pF	±10%	GCG155R71H821KA01#		
			1000pF	±10%	GCG155R71H102KA01#		
			1200pF	±10%	GCG155R71H122KA01#		
			1500pF	±10%	GCG155R71H152KA01#		
			1800pF	±10%	GCG155R71H182KA01#		
			2200pF	±10%	GCG155R71H222KA01#		
			2700pF	±10%	GCG155R71H272KA01#		
			3300pF	±10%	GCG155R71H332KA01#		
			3900pF	±10%	GCG155R71H392KA01#		
			4700pF	±10%	GCG155R71H472KA01#		
			25Vdc	X8L	5600pF	±10%	GCG155L81E562KA01#
					6800pF	±10%	GCG155L81E682KA01#
					8200pF	±10%	GCG155L81E822KA01#
					10000pF	±10%	GCG155L81E103KA01#
	X7R	5600pF		±10%	GCG155R71E562KA01#		
		6800pF		±10%	GCG155R71E682KA01#		
		8200pF		±10%	GCG155R71E822KA01#		
		10000pF		±10%	GCG155R71E103KA01#		
		16Vdc		X8L	15000pF	±10%	GCG155L81C153KA01#
					18000pF	±10%	GCG155L81C183KA01#
					22000pF	±10%	GCG155L81C223KA01#
	27000pF		±10%		GCG155L81C273KA01#		
	33000pF		±10%		GCG155L81C333KA01#		
	39000pF		±10%		GCG155L81C393KA01#		
	47000pF		±10%		GCG155L81C473KA01#		
	X7R		15000pF	±10%	GCG155R71C153KA01#		
			18000pF	±10%	GCG155R71C183KA01#		
			22000pF	±10%	GCG155R71C223KA01#		
				27000pF	±10%	GCG155R71C273KA01#	
				33000pF	±10%	GCG155R71C333KA01#	
				39000pF	±10%	GCG155R71C393KA01#	
				47000pF	±10%	GCG155R71C473KA01#	
				56000pF	±10%	GCG155R71C563KA01#	
				68000pF	±10%	GCG155R71C683KA01#	
				82000pF	±10%	GCG155R71C823KA01#	
0.1μF				±10%	GCG155R71C104KA01#		

■ 1.6x0.8mm

T max.	Rated Voltage	TC Code	Cap.	Tol.	Part Number
0.9mm	100Vdc	X8R	1000pF	±10%	GCG188R92A102KA01#
			1200pF	±10%	GCG188R92A122KA01#
			1500pF	±10%	GCG188R92A152KA01#
			1800pF	±10%	GCG188R92A182KA01#

T max.	Rated Voltage	TC Code	Cap.	Tol.	Part Number		
0.9mm	100Vdc	X8R	2200pF	±10%	GCG188R92A222KA01#		
			2700pF	±10%	GCG188R92A272KA01#		
			3300pF	±10%	GCG188R92A332KA01#		
			3900pF	±10%	GCG188R92A392KA01#		
			4700pF	±10%	GCG188R92A472KA01#		
			5600pF	±10%	GCG188R92A562KA01#		
			6800pF	±10%	GCG188R92A682KA01#		
			8200pF	±10%	GCG188R92A822KA01#		
			10000pF	±10%	GCG188R92A103KA01#		
			12000pF	±10%	GCG188R92A123KA01#		
			15000pF	±10%	GCG188R92A153KA01#		
			18000pF	±10%	GCG188R92A183KA01#		
			22000pF	±10%	GCG188R92A223KA01#		
			27000pF	±10%	GCG188R92A273KA01#		
			33000pF	±10%	GCG188R92A333KA01#		
			39000pF	±10%	GCG188R92A393KA01#		
			47000pF	±10%	GCG188R92A473KA01#		
			56000pF	±10%	GCG188R92A563KA01#		
			68000pF	±10%	GCG188R92A683KA01#		
			50Vdc	X8L	220pF	±10%	GCG188L81H221KA01#
					270pF	±10%	GCG188L81H271KA01#
	330pF	±10%			GCG188L81H331KA01#		
	390pF	±10%			GCG188L81H391KA01#		
	470pF	±10%			GCG188L81H471KA01#		
	560pF	±10%			GCG188L81H561KA01#		
	680pF	±10%			GCG188L81H681KA01#		
	820pF	±10%			GCG188L81H821KA01#		
	1000pF	±10%			GCG188L81H102KA01#		
	1200pF	±10%			GCG188L81H122KA01#		
	1500pF	±10%			GCG188L81H152KA01#		
	1800pF	±10%		GCG188L81H182KA01#			
	2200pF	±10%		GCG188L81H222KA01#			
	2700pF	±10%		GCG188L81H272KA01#			
	3300pF	±10%		GCG188L81H332KA01#			
	3900pF	±10%		GCG188L81H392KA01#			
	4700pF	±10%		GCG188L81H472KA01#			
	5600pF	±10%		GCG188L81H562KA01#			
	6800pF	±10%		GCG188L81H682KA01#			
	8200pF	±10%		GCG188L81H822KA01#			
	10000pF	±10%		GCG188L81H103KA01#			
	12000pF	±10%	GCG188L81H123KA01#				
	15000pF	±10%	GCG188L81H153KA01#				
18000pF	±10%	GCG188L81H183KA01#					
22000pF	±10%	GCG188L81H223KA01#					
X8R	1200pF	±10%	GCG188R91H122KA03#				
	1500pF	±10%	GCG188R91H152KA03#				
	2200pF	±10%	GCG188R91H222KA03#				
	2700pF	±10%	GCG188R91H272KA03#				
	3300pF	±10%	GCG188R91H332KA03#				
	3900pF	±10%	GCG188R91H392KA03#				
	4700pF	±10%	GCG188R91H472KA03#				
	5600pF	±10%	GCG188R91H562KA03#				
	6800pF	±10%	GCG188R91H682KA03#				
	8200pF	±10%	GCG188R91H822KA03#				

GCM Series

GCD Series

GCE Series

GCG Series

GCJ Series

GC3 Series

KCM Series

KC3 Series

⚠Caution/Notice

Part number # indicates the package specification code.

GCG Series High Dielectric Constant Type AEC-Q200 Deflecting crack Soldering crack Part Number List

(→ ■ 1.6x0.8mm)

T max.	Rated Voltage	TC Code	Cap.	Tol.	Part Number		
0.9mm	50Vdc	X8R	10000pF	±10%	GCG188R91H103KA03#		
			15000pF	±10%	GCG188R91H153KA03#		
			22000pF	±10%	GCG188R91H223KA03#		
			33000pF	±10%	GCG188R91H333KA03#		
			47000pF	±10%	GCG188R91H473KA03#		
			0.10μF	±10%	GCG188R91H104KA01#		
			0.12μF	±10%	GCG188R91H124KA01#		
			0.15μF	±10%	GCG188R91H154KA01#		
			0.18μF	±10%	GCG188R91H184KA01#		
			0.22μF	±10%	GCG188R91H224KA01#		
		X7R	27000pF	±10%	GCG188R71H273KA12#		
			33000pF	±10%	GCG188R71H333KA12#		
			39000pF	±10%	GCG188R71H393KA12#		
			47000pF	±10%	GCG188R71H473KA12#		
			56000pF	±10%	GCG188R71H563KA12#		
			68000pF	±10%	GCG188R71H683KA12#		
			82000pF	±10%	GCG188R71H823KA12#		
			25Vdc	X8R	1000pF	±10%	GCG188R91E102KA01#
					1200pF	±10%	GCG188R91E122KA01#
					1500pF	±10%	GCG188R91E152KA01#
	1800pF	±10%			GCG188R91E182KA01#		
	2200pF	±10%			GCG188R91E222KA01#		
	X7R	2700pF		±10%	GCG188R91E272KA01#		
		3300pF		±10%	GCG188R91E332KA01#		
		3900pF		±10%	GCG188R91E392KA01#		
		4700pF		±10%	GCG188R91E472KA01#		
		5600pF		±10%	GCG188R91E562KA01#		
	16Vdc	X8L	6800pF	±10%	GCG188R91E682KA01#		
			8200pF	±10%	GCG188R91E822KA01#		
			10000pF	±10%	GCG188R91E103KA01#		
			15000pF	±10%	GCG188R91E153KA01#		
			22000pF	±10%	GCG188R91E223KA01#		
			33000pF	±10%	GCG188R91E333KA01#		
			47000pF	±10%	GCG188R91E473KA01#		
			68000pF	±10%	GCG188R91E683KA03#		
			0.33μF	±10%	GCG188R91E334KA01#		
			0.39μF	±10%	GCG188R91E394KA01#		
		X7R	0.47μF	±10%	GCG188R91E474KA01#		
			0.12μF	±10%	GCG188R71E124KA12#		
			0.15μF	±10%	GCG188R71E154KA12#		
0.18μF			±10%	GCG188R71E184KA12#			
0.22μF			±10%	GCG188R71E224KA12#			
X8R	0.15μF	±10%	GCG188L81C154KA01#				
	0.22μF	±10%	GCG188L81C224KA01#				
	68000pF	±10%	GCG188R91C683KA01#				
	0.10μF	±10%	GCG188R91C104KA01#				

T max.	Rated Voltage	TC Code	Cap.	Tol.	Part Number	
0.95mm	50Vdc	X8R	22000pF	±10%	GCG219R91H223KA03#	
			10000pF	±10%	GCG219R91E103KA01#	
			15000pF	±10%	GCG219R91E153KA01#	
			22000pF	±10%	GCG219R91E223KA01#	
			1.45mm	50Vdc	X8L	27000pF
	33000pF	±10%				GCG21BL81H333KA01#
	39000pF	±10%				GCG21BL81H393KA01#
	47000pF	±10%				GCG21BL81H473KA01#
	0.10μF	±10%				GCG21BL81H104KA03#
	25Vdc	X8R	33000pF	±10%	GCG21BR91H333KA03#	
47000pF			±10%	GCG21BR91H473KA03#		
56000pF			±10%	GCG21BR91H563KA03#		
68000pF			±10%	GCG21BR91H683KA03#		
0.10μF			±10%	GCG21BR91H104KA03#		
X7R		0.15μF	±10%	GCG21BR71H154KA01#		
		0.18μF	±10%	GCG21BR71H184KA01#		
		0.22μF	±10%	GCG21BR71H224KA01#		
		X8L	0.10μF	±10%	GCG21BL81E104KA01#	
			0.33μF	±10%	GCG21BL81E334KA01#	
X8R			33000pF	±10%	GCG21BR91E333KA01#	
			39000pF	±10%	GCG21BR91E393KA01#	
			47000pF	±10%	GCG21BR91E473KA01#	
		82000pF	±10%	GCG21BR91E823KA01#		
		0.10μF	±10%	GCG21BR91E104KA01#		
16Vdc	X8L	0.15μF	±10%	GCG21BR91E154KA03#		
		0.18μF	±10%	GCG21BR91E184KA03#		
		0.22μF	±10%	GCG21BR91E224KA03#		
		X7R	0.27μF	±10%	GCG21BR71E274KA01#	
			0.33μF	±10%	GCG21BR71E334KA01#	
	0.39μF		±10%	GCG21BR71E394KA01#		
	0.47μF		±10%	GCG21BR71E474KA01#		
	0.56μF		±10%	GCG21BR71E564KA01#		
	X8R	0.68μF	±10%	GCG21BR71E684KA01#		
		0.82μF	±10%	GCG21BR71E824KA01#		
1.0μF		±10%	GCG21BR71E105KA12#			
X8L		0.33μF	±10%	GCG21BL81C334KA01#		
		0.39μF	±10%	GCG21BL81C394KA01#		
	0.47μF	±10%	GCG21BL81C474KA01#			
	0.56μF	±10%	GCG21BL81C564KA01#			
	0.68μF	±10%	GCG21BL81C684KA01#			
X7R	0.82μF	±10%	GCG21BL81C824KA01#			
	1.0μF	±10%	GCG21BR71E105KA12#			
	4.7μF	±10%	GCG21BR71C475KA12#			

■ 3.2x1.6mm

T max.	Rated Voltage	TC Code	Cap.	Tol.	Part Number		
1.35mm	50Vdc	X8R	0.15μF	±10%	GCG31MR91H154KA03#		
			0.22μF	±10%	GCG31MR91H224KA03#		
			0.33μF	±10%	GCG31MR91H334KA03#		
			25Vdc	X8R	0.15μF	±10%	GCG31MR91E154KA01#
					0.22μF	±10%	GCG31MR91E224KA01#
	0.33μF	±10%			GCG31MR91E334KA01#		
	X7R	1.0μF			±10%	GCG31MR71E105KA01#	

■ 2.0x1.25mm

T max.	Rated Voltage	TC Code	Cap.	Tol.	Part Number
0.95mm	50Vdc	X8R	10000pF	±10%	GCG219R91H103KA03#
			15000pF	±10%	GCG219R91H153KA03#
			18000pF	±10%	GCG219R91H183KA03#

Part number # indicates the package specification code.

GCM Series
 GCD Series
 GCE Series
 GCG Series
 GCJ Series
 GC3 Series
 KCM Series
 KC3 Series
 ⚠Caution/Notice

GCG Series High Dielectric Constant Type AEC-Q200 Defecting crack Soldering crack Part Number List

(→ ■ 3.2×1.6mm)

T max.	Rated Voltage	TC Code	Cap.	Tol.	Part Number
1.35mm	25Vdc	X7R	1.2μF	±10%	GCG31MR71E125KA01#
			1.5μF	±10%	GCG31MR71E155KA01#
			2.2μF	±10%	GCG31MR71E225KA12#
	16Vdc	X8L	1.0μF	±10%	GCG31ML81C105KA01#
			1.5μF	±10%	GCG31ML81C155KA01#
1.9mm	25Vdc	X8R	0.68μF	±10%	GCG31CR91E684KA03#
			3.3μF	±10%	GCG31CR71E335KA01#
		X7R	3.9μF	±10%	GCG31CR71E395KA01#
			4.7μF	±10%	GCG31CR71E475KA01#
	16Vdc	X8L	3.3μF	±10%	GCG31CL81C335KA01#
			4.7μF	±10%	GCG31CL81C475KA01#
		X8R	0.68μF	±10%	GCG31CR91C684KA01#
			1.0μF	±10%	GCG31CR91C105KA01#

■ 3.2×2.5mm

T max.	Rated Voltage	TC Code	Cap.	Tol.	Part Number
2.3mm	25Vdc	X7R	3.3μF	±10%	GCG32DR71E335KA01#
2.8mm	25Vdc	X7R	4.7μF	±10%	GCG32ER71E475KA01#
			10μF	±10%	GCG32ER71E106KA12#

GCM Series

GCD Series

GCE Series

GCG Series

GCJ Series

GC3 Series

KCM Series

KC3 Series

⚠Caution/Notice

Resin External Electrode Product

GCJ Series



AEC-Q200 **Fail safe** **Deflecting crack**

The resin external electrodes prevent the occurrence of cracking caused by deflection stress after board mounting!

Features

1 The resin external electrodes suppress cracks by board deflection.

Cracking of the ceramic element is suppressed by the resin of the external electrodes, which releases the stress.

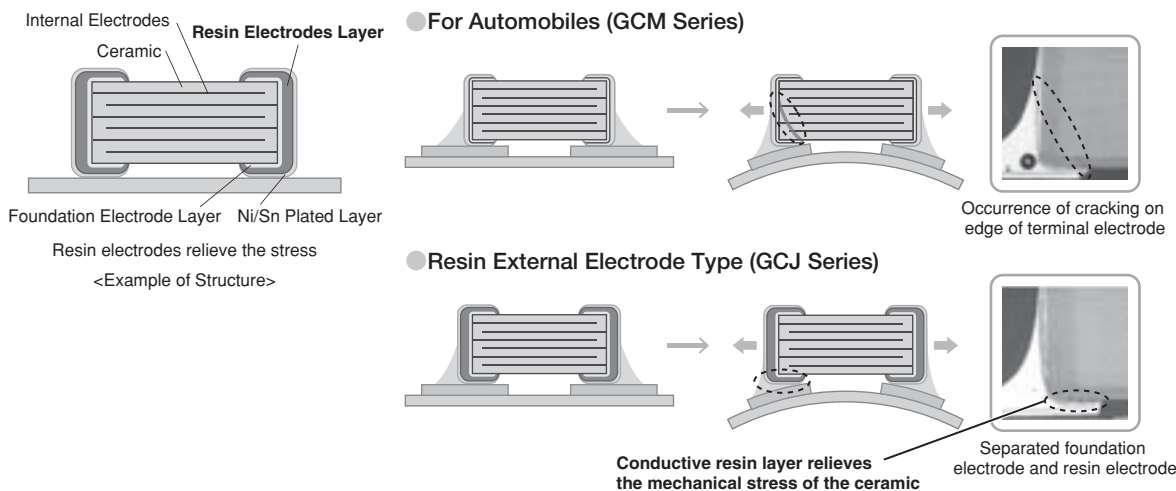

2 Suppresses the occurrence of cracking caused by deflection stress at the time of board mounting, etc.

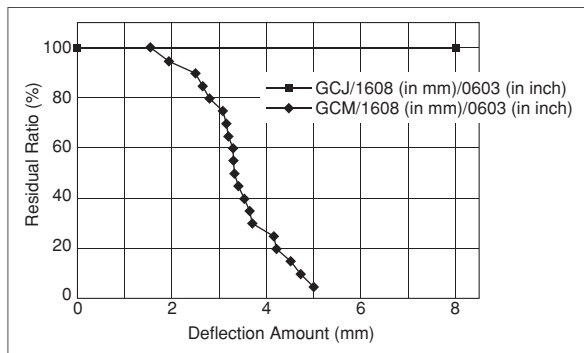

Due to the specification of the measuring instrument, measurements can be performed up to 8mm.

3 Ideal for automobiles.

This AEC-Q200 conforming product is ideal for the ECU, control circuits of headlights, etc. of automobiles.

Specifications

Size	1.6×0.8mm to 5.7×5.0mm
Rated Voltage	6.3Vdc to 1kVdc
Capacitance	220pF to 47μF
Main Applications	Battery lines and power trains for automobiles

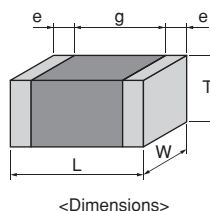

GCJ Series High Dielectric Constant Type AEC-Q200 Fail safe Deflecting crack Part Number List

■ 1.6x0.8mm

T max.	Rated Voltage	TC Code	Cap.	Tol.	Part Number		
0.9mm	100Vdc	X8R	1000pF	±10%	GCJ188R92A102KA01#		
			1200pF	±10%	GCJ188R92A122KA01#		
			1500pF	±10%	GCJ188R92A152KA01#		
			1800pF	±10%	GCJ188R92A182KA01#		
			2200pF	±10%	GCJ188R92A222KA01#		
			2700pF	±10%	GCJ188R92A272KA01#		
			3300pF	±10%	GCJ188R92A332KA01#		
			3900pF	±10%	GCJ188R92A392KA01#		
			4700pF	±10%	GCJ188R92A472KA01#		
			5600pF	±10%	GCJ188R92A562KA01#		
			6800pF	±10%	GCJ188R92A682KA01#		
			8200pF	±10%	GCJ188R92A822KA01#		
			10000pF	±10%	GCJ188R92A103KA01#		
			12000pF	±10%	GCJ188R92A123KA01#		
			15000pF	±10%	GCJ188R92A153KA01#		
			18000pF	±10%	GCJ188R92A183KA01#		
			22000pF	±10%	GCJ188R92A223KA01#		
			27000pF	±10%	GCJ188R92A273KA01#		
			33000pF	±10%	GCJ188R92A333KA01#		
			39000pF	±10%	GCJ188R92A393KA01#		
			47000pF	±10%	GCJ188R92A473KA01#		
			56000pF	±10%	GCJ188R92A563KA01#		
			68000pF	±10%	GCJ188R92A683KA01#		
			X7R	1000pF	±10%	GCJ188R72A102KA01#	
		1200pF		±10%	GCJ188R72A122KA01#		
		1500pF		±10%	GCJ188R72A152KA01#		
		1800pF		±10%	GCJ188R72A182KA01#		
		2200pF		±10%	GCJ188R72A222KA01#		
		2700pF		±10%	GCJ188R72A272KA01#		
		3300pF		±10%	GCJ188R72A332KA01#		
		3900pF		±10%	GCJ188R72A392KA01#		
		4700pF		±10%	GCJ188R72A472KA01#		
		5600pF		±10%	GCJ188R72A562KA01#		
		6800pF		±10%	GCJ188R72A682KA01#		
		8200pF		±10%	GCJ188R72A822KA01#		
		10000pF		±10%	GCJ188R72A103KA01#		
		12000pF		±10%	GCJ188R72A123KA01#		
		15000pF		±10%	GCJ188R72A153KA01#		
		18000pF		±10%	GCJ188R72A183KA01#		
		22000pF		±10%	GCJ188R72A223KA01#		
		0.10μF		±10%	GCJ188R72A104KA01#		
		50Vdc		X8L	1000pF	±10%	GCJ188L81H102KA01#
					1200pF	±10%	GCJ188L81H122KA01#
					1500pF	±10%	GCJ188L81H152KA01#
					1800pF	±10%	GCJ188L81H182KA01#
					2200pF	±10%	GCJ188L81H222KA01#
					2700pF	±10%	GCJ188L81H272KA01#
			3300pF		±10%	GCJ188L81H332KA01#	
	3900pF		±10%		GCJ188L81H392KA01#		
	X8R		4700pF	±10%	GCJ188L81H472KA01#		
			5600pF	±10%	GCJ188L81H562KA01#		
			6800pF	±10%	GCJ188L81H682KA01#		

T max.	Rated Voltage	TC Code	Cap.	Tol.	Part Number	
0.9mm	50Vdc	X8L	8200pF	±10%	GCJ188L81H822KA01#	
			10000pF	±10%	GCJ188L81H103KA01#	
			12000pF	±10%	GCJ188L81H123KA01#	
			15000pF	±10%	GCJ188L81H153KA01#	
			18000pF	±10%	GCJ188L81H183KA01#	
			22000pF	±10%	GCJ188L81H223KA01#	
			X8R	4700pF	±10%	GCJ188R91H472KA01#
				10000pF	±10%	GCJ188R91H103KA01#
				0.10μF	±10%	GCJ188R91H104KA01#
				0.12μF	±10%	GCJ188R91H124KA01#
				0.15μF	±10%	GCJ188R91H154KA01#
				0.18μF	±10%	GCJ188R91H184KA01#
		0.22μF		±10%	GCJ188R91H224KA01#	
		X7R		1000pF	±10%	GCJ188R71H102KA01#
				1200pF	±10%	GCJ188R71H122KA01#
				1500pF	±10%	GCJ188R71H152KA01#
				1800pF	±10%	GCJ188R71H182KA01#
				2200pF	±10%	GCJ188R71H222KA01#
			2700pF	±10%	GCJ188R71H272KA01#	
			3300pF	±10%	GCJ188R71H332KA01#	
			3900pF	±10%	GCJ188R71H392KA01#	
			4700pF	±10%	GCJ188R71H472KA01#	
			5600pF	±10%	GCJ188R71H562KA01#	
			6800pF	±10%	GCJ188R71H682KA01#	
			8200pF	±10%	GCJ188R71H822KA01#	
			10000pF	±10%	GCJ188R71H103KA01#	
			12000pF	±10%	GCJ188R71H123KA01#	
			15000pF	±10%	GCJ188R71H153KA01#	
			18000pF	±10%	GCJ188R71H183KA01#	
			22000pF	±10%	GCJ188R71H223KA01#	
			33000pF	±10%	GCJ188R71H333KA12#	
			39000pF	±10%	GCJ188R71H393KA12#	
			47000pF	±10%	GCJ188R71H473KA12#	
			56000pF	±10%	GCJ188R71H563KA12#	
			68000pF	±10%	GCJ188R71H683KA12#	
			82000pF	±10%	GCJ188R71H823KA12#	
			35Vdc	X8L	0.10μF	±10%
		0.15μF			±10%	GCJ188R71H154KA01#
		0.22μF			±10%	GCJ188R71H224KA01#
		33000pF			±10%	GCJ188L8YA333KA01#
		39000pF			±10%	GCJ188L8YA393KA01#
		56000pF			±10%	GCJ188L8YA563KA01#
		68000pF			±10%	GCJ188L8YA683KA01#
		25Vdc			X8L	33000pF
			39000pF	±10%		GCJ188L81E393KA01#
			56000pF	±10%		GCJ188L81E563KA01#
			68000pF	±10%		GCJ188L81E683KA01#
			82000pF	±10%		GCJ188L81E823KA01#
	0.15μF		±10%	GCJ188L81E154KA01#		
	0.18μF		±10%	GCJ188L81E184KA01#		
	0.22μF		±10%	GCJ188L81E224KA01#		
	X8R		0.33μF	±10%	GCJ188R91E334KA01#	
0.39μF			±10%	GCJ188R91E394KA01#		
0.47μF			±10%	GCJ188R91E474KA01#		

GCM Series

GCD Series

GCE Series

GCG Series

GCJ Series

GC3 Series

KCM Series

KC3 Series

⚠Caution/Notice

Part number # indicates the package specification code.

GCJ Series High Dielectric Constant Type AEC-Q200 Fail safe Deflecting crack Part Number List

(→ ■ 1.6x0.8mm)

T max.	Rated Voltage	TC Code	Cap.	Tol.	Part Number			
0.9mm	25Vdc	X7R	1000pF	±10%	GCJ188R71E102KA01#			
			1200pF	±10%	GCJ188R71E122KA01#			
			1500pF	±10%	GCJ188R71E152KA01#			
			1800pF	±10%	GCJ188R71E182KA01#			
			2200pF	±10%	GCJ188R71E222KA01#			
			2700pF	±10%	GCJ188R71E272KA01#			
			3300pF	±10%	GCJ188R71E332KA01#			
			3900pF	±10%	GCJ188R71E392KA01#			
			4700pF	±10%	GCJ188R71E472KA01#			
			5600pF	±10%	GCJ188R71E562KA01#			
			6800pF	±10%	GCJ188R71E682KA01#			
			8200pF	±10%	GCJ188R71E822KA01#			
			10000pF	±10%	GCJ188R71E103KA01#			
			12000pF	±10%	GCJ188R71E123KA01#			
			15000pF	±10%	GCJ188R71E153KA01#			
			18000pF	±10%	GCJ188R71E183KA01#			
			22000pF	±10%	GCJ188R71E223KA01#			
			27000pF	±10%	GCJ188R71E273KA01#			
			33000pF	±10%	GCJ188R71E333KA01#			
			39000pF	±10%	GCJ188R71E393KA01#			
			47000pF	±10%	GCJ188R71E473KA01#			
			56000pF	±10%	GCJ188R71E563KA12#			
			68000pF	±10%	GCJ188R71E683KA12#			
			82000pF	±10%	GCJ188R71E823KA12#			
			0.10μF	±10%	GCJ188R71E104KA12#			
			0.12μF	±10%	GCJ188R71E124KA01#			
			0.15μF	±10%	GCJ188R71E154KA01#			
			0.18μF	±10%	GCJ188R71E184KA12#			
			0.22μF	±10%	GCJ188R71E224KA12#			
			1.0μF	±10%	GCJ188R71E105KA01#			
			16Vdc	X8L	X8L	33000pF	±10%	GCJ188L81C333KA01#
						39000pF	±10%	GCJ188L81C393KA01#
						47000pF	±10%	GCJ188L81C473KA01#
						56000pF	±10%	GCJ188L81C563KA01#
						68000pF	±10%	GCJ188L81C683KA01#
						82000pF	±10%	GCJ188L81C823KA01#
0.10μF	±10%	GCJ188L81C104KA01#						
0.12μF	±10%	GCJ188L81C124KA01#						
0.15μF	±10%	GCJ188L81C154KA01#						
0.18μF	±10%	GCJ188L81C184KA01#						
0.22μF	±10%	GCJ188L81C224KA01#						
X7R	X7R	X7R				10000pF	±10%	GCJ188R71C103KA01#
						27000pF	±10%	GCJ188R71C273KA01#
						33000pF	±10%	GCJ188R71C333KA01#
						39000pF	±10%	GCJ188R71C393KA01#
						47000pF	±10%	GCJ188R71C473KA01#
						56000pF	±10%	GCJ188R71C563KA01#
						68000pF	±10%	GCJ188R71C683KA01#
				82000pF	±10%	GCJ188R71C823KA01#		
				0.10μF	±10%	GCJ188R71C104KA01#		
				0.12μF	±10%	GCJ188R71C124KA01#		
				0.15μF	±10%	GCJ188R71C154KA01#		
				0.18μF	±10%	GCJ188R71C184KA01#		
				0.22μF	±10%	GCJ188R71C224KA01#		

T max.	Rated Voltage	TC Code	Cap.	Tol.	Part Number
0.9mm	16Vdc	X7R	0.27μF	±10%	GCJ188R71C274KA01#
			0.33μF	±10%	GCJ188R71C334KA01#
			0.39μF	±10%	GCJ188R71C394KA12#
			0.47μF	±10%	GCJ188R71C474KA12#
			0.12μF	±10%	GCJ188R71A124KA01#
	10Vdc	X7R	0.15μF	±10%	GCJ188R71A154KA01#
			0.18μF	±10%	GCJ188R71A184KA01#
			0.22μF	±10%	GCJ188R71A224KA01#
			2.2μF	±10%	GCJ188R70J225KE01#
			6.3Vdc	X7R	2.2μF

■ 2.0x1.25mm

T max.	Rated Voltage	TC Code	Cap.	Tol.	Part Number			
0.7mm	100Vdc	X7R	1000pF	±10%	GCJ216R72A102KA01#			
			1200pF	±10%	GCJ216R72A122KA01#			
			1500pF	±10%	GCJ216R72A152KA01#			
			1800pF	±10%	GCJ216R72A182KA01#			
			2200pF	±10%	GCJ216R72A222KA01#			
			2700pF	±10%	GCJ216R72A272KA01#			
			3300pF	±10%	GCJ216R72A332KA01#			
			3900pF	±10%	GCJ216R72A392KA01#			
			4700pF	±10%	GCJ216R72A472KA01#			
			5600pF	±10%	GCJ216R72A562KA01#			
			6800pF	±10%	GCJ216R72A682KA01#			
			8200pF	±10%	GCJ216R72A822KA01#			
			10000pF	±10%	GCJ216R72A103KA01#			
			12000pF	±10%	GCJ216R72A123KA01#			
			15000pF	±10%	GCJ216R72A153KA01#			
			18000pF	±10%	GCJ216R72A183KA01#			
			22000pF	±10%	GCJ216R72A223KA01#			
			50Vdc	X7R	X7R	330pF	±10%	GCJ216R71H331KA01#
						390pF	±10%	GCJ216R71H391KA01#
						470pF	±10%	GCJ216R71H471KA01#
						560pF	±10%	GCJ216R71H561KA01#
						680pF	±10%	GCJ216R71H681KA01#
						820pF	±10%	GCJ216R71H821KA01#
						1000pF	±10%	GCJ216R71H102KA01#
1200pF	±10%	GCJ216R71H122KA01#						
1500pF	±10%	GCJ216R71H152KA01#						
1800pF	±10%	GCJ216R71H182KA01#						
2200pF	±10%	GCJ216R71H222KA01#						
2700pF	±10%	GCJ216R71H272KA01#						
3300pF	±10%	GCJ216R71H332KA01#						
3900pF	±10%	GCJ216R71H392KA01#						
4700pF	±10%	GCJ216R71H472KA01#						
5600pF	±10%	GCJ216R71H562KA01#						
6800pF	±10%	GCJ216R71H682KA01#						
8200pF	±10%	GCJ216R71H822KA01#						
10000pF	±10%	GCJ216R71H103KA01#						
12000pF	±10%	GCJ216R71H123KA01#						
15000pF	±10%	GCJ216R71H153KA01#						
18000pF	±10%	GCJ216R71H183KA01#						
22000pF	±10%	GCJ216R71H223KA01#						

Part number # indicates the package specification code.

GCM Series
 GCD Series
 GCE Series
 GCG Series
GCJ Series
 GCK Series
 KCM Series
 KC3 Series
 ⚠Caution/Notice

GCJ Series High Dielectric Constant Type AEC-Q200 Fail safe Deflecting crack Part Number List

(→ ■ 2.0x1.25mm)

T max.	Rated Voltage	TC Code	Cap.	Tol.	Part Number	T max.	Rated Voltage	TC Code	Cap.	Tol.	Part Number			
0.7mm	25Vdc	X7R	470pF	±10%	GCJ216R71E471KA01#	1.45mm	100Vdc	X7R	0.10μF	±10%	GCJ21BR72A104KA01#			
			560pF	±10%	GCJ216R71E561KA01#				50Vdc	X8L	27000pF	±10%	GCJ21BL81H273KA01#	
			680pF	±10%	GCJ216R71E681KA01#						33000pF	±10%	GCJ21BL81H333KA01#	
			820pF	±10%	GCJ216R71E821KA01#						39000pF	±10%	GCJ21BL81H393KA01#	
			1000pF	±10%	GCJ216R71E102KA01#						47000pF	±10%	GCJ21BL81H473KA01#	
			1200pF	±10%	GCJ216R71E122KA01#						56000pF	±10%	GCJ21BL81H563KA01#	
			1500pF	±10%	GCJ216R71E152KA01#						68000pF	±10%	GCJ21BL81H683KA01#	
			1800pF	±10%	GCJ216R71E182KA01#						82000pF	±10%	GCJ21BL81H823KA01#	
			2200pF	±10%	GCJ216R71E222KA01#						0.10μF	±10%	GCJ21BL81H104KA01#	
			2700pF	±10%	GCJ216R71E272KA01#						X7R	47000pF	±10%	GCJ21BR71H473KA01#
			3300pF	±10%	GCJ216R71E332KA01#		56000pF	±10%				GCJ21BR71H563KA01#		
			3900pF	±10%	GCJ216R71E392KA01#		68000pF	±10%	GCJ21BR71H683KA01#					
			4700pF	±10%	GCJ216R71E472KA01#		82000pF	±10%	GCJ21BR71H823KA01#					
			5600pF	±10%	GCJ216R71E562KA01#		0.10μF	±10%	GCJ21BR71H104KA01#					
			6800pF	±10%	GCJ216R71E682KA01#		0.12μF	±10%	GCJ21BR71H124KA01#					
			8200pF	±10%	GCJ216R71E822KA01#		0.15μF	±10%	GCJ21BR71H154KA01#					
			10000pF	±10%	GCJ216R71E103KA01#		0.18μF	±10%	GCJ21BR71H184KA01#					
			12000pF	±10%	GCJ216R71E123KA01#		0.22μF	±10%	GCJ21BR71H224KA01#					
			0.95mm	100Vdc	X7R		220pF	±10%	GCJ219R72A221KA01#	35Vdc		X8L	0.12μF	±10%
							270pF	±10%	GCJ219R72A271KA01#		0.15μF		±10%	GCJ21BL8YA154KA01#
330pF	±10%	GCJ219R72A331KA01#				0.18μF	±10%	GCJ21BL8YA184KA01#						
390pF	±10%	GCJ219R72A391KA01#				0.22μF	±10%	GCJ21BL8YA224KA01#						
470pF	±10%	GCJ219R72A471KA01#				0.33μF	±10%	GCJ21BL8YA334KA01#						
560pF	±10%	GCJ219R72A561KA01#				0.47μF	±10%	GCJ21BL8YA474KA01#						
680pF	±10%	GCJ219R72A681KA01#				25Vdc	X8L	0.12μF	±10%		GCJ21BL81E124KA01#			
820pF	±10%	GCJ219R72A821KA01#						0.15μF	±10%		GCJ21BL81E154KA01#			
27000pF	±10%	GCJ219R72A273KA01#						0.18μF	±10%		GCJ21BL81E184KA01#			
33000pF	±10%	GCJ219R72A333KA01#						0.22μF	±10%		GCJ21BL81E224KA01#			
39000pF	±10%	GCJ219R72A393KA01#		0.27μF	±10%			GCJ21BL81E274KA01#						
50Vdc	X7R	27000pF		±10%	GCJ219R71H273KA01#			0.33μF	±10%	GCJ21BL81E334KA01#				
		33000pF		±10%	GCJ219R71H333KA01#			0.39μF	±10%	GCJ21BL81E394KA01#				
		39000pF		±10%	GCJ219R71H393KA01#			0.47μF	±10%	GCJ21BL81E474KA01#				
		0.33μF		±10%	GCJ219R71H334KA12#			0.68μF	±10%	GCJ21BL81E684KA01#				
		25Vdc		X7R	15000pF			±10%	GCJ219R71E153KA01#	0.82μF	±10%	GCJ21BL81E824KA01#		
					18000pF	±10%	GCJ219R71E183KA01#	1.0μF	±10%	GCJ21BL81E105KA01#				
					22000pF	±10%	GCJ219R71E223KA01#	X7R	27000pF	±10%	GCJ21BR71E273KA01#			
					0.33μF	±10%	GCJ219R71E334KA01#		33000pF	±10%	GCJ21BR71E333KA01#			
					0.47μF	±10%	GCJ219R71E474KA12#		39000pF	±10%	GCJ21BR71E393KA01#			
			16Vdc		X7R	0.68μF	±10%		GCJ219R71C684KA01#	47000pF	±10%	GCJ21BR71E473KA01#		
0.82μF	±10%	GCJ219R71C824KA01#		56000pF		±10%	GCJ21BR71E563KA01#							
1.0μF	±10%	GCJ219R71C105KA01#		68000pF		±10%	GCJ21BR71E683KA01#							
1.0mm	250Vdc	X7R		1000pF		±10%	GCJ21AR72E102KXJ1#	82000pF	±10%	GCJ21BR71E823KA01#				
			1500pF	±10%	GCJ21AR72E152KXJ1#	0.10μF	±10%	GCJ21BR71E104KA01#						
			2200pF	±10%	GCJ21AR72E222KXJ1#	0.27μF	±10%	GCJ21BR71E274KA01#						
			3300pF	±10%	GCJ21AR72E332KXJ1#	0.39μF	±10%	GCJ21BR71E394KA01#						
			4700pF	±10%	GCJ21AR72E472KXJ1#	0.56μF	±10%	GCJ21BR71E564KA12#						
			6800pF	±10%	GCJ21AR72E682KXJ1#	0.68μF	±10%	GCJ21BR71E684KA12#						
			1.45mm	250Vdc	X7R	10000pF	±10%	GCJ21BR72E103KXJ3#	0.82μF	±10%	GCJ21BR71E824KA12#			
						15000pF	±10%	GCJ21BR72E153KXJ3#	1.0μF	±10%	GCJ21BR71E105KA12#			
						22000pF	±10%	GCJ21BR72E223KXJ3#	1.5μF	±10%	GCJ21BR71E155KA01#			
						100Vdc	X7R	47000pF	±10%	GCJ21BR72A473KA01#	2.2μF	±10%	GCJ21BR71E225KA01#	
56000pF	±10%	GCJ21BR72A563KA01#						X8L	0.56μF	±10%	GCJ21BL81C564KA01#			
68000pF	±10%	GCJ21BR72A683KA01#												
82000pF	±10%	GCJ21BR72A823KA01#												

GCM Series
 GCD Series
 GCE Series
 GCG Series
 GCJ Series
 GCG3 Series
 KCM Series
 KC3 Series
 ⚠Caution/Notice

Part number # indicates the package specification code.

GCJ Series High Dielectric Constant Type AEC-Q200 Fail safe Defecting crack Part Number List

(→ ■ 2.0x1.25mm)

T max.	Rated Voltage	TC Code	Cap.	Tol.	Part Number
1.45mm	16Vdc	X8L	0.68μF	±10%	GCJ21BL81C684KA01#
			0.82μF	±10%	GCJ21BL81C824KA01#
			1.0μF	±10%	GCJ21BL81C105KA01#
		X7R	0.27μF	±10%	GCJ21BR71C274KA01#
			0.33μF	±10%	GCJ21BR71C334KA01#
			0.39μF	±10%	GCJ21BR71C394KA01#
			0.47μF	±10%	GCJ21BR71C474KA01#
	10Vdc	X7R	0.56μF	±10%	GCJ21BR71C564KA01#
			1.0μF	±10%	GCJ21BR71C105KA01#
			2.2μF	±10%	GCJ21BR71C225KA13#
	10Vdc	X7R	4.7μF	±10%	GCJ21BR71C475KA01#
			2.2μF	±10%	GCJ21BR71A225KA01#
			10μF	±10%	GCJ21BR71A106KE01#

■ 3.2x1.6mm

T max.	Rated Voltage	TC Code	Cap.	Tol.	Part Number			
0.95mm	100Vdc	X7R	0.10μF	±10%	GCJ319R72A104KA01#			
	50Vdc	X7R	0.10μF	±10%	GCJ319R71H104KA01#			
			0.12μF	±10%	GCJ319R71H124KA01#			
1.25mm	1000Vdc	X7R	1000pF	±10%	GCJ31BR73A102KXJ1#			
			1500pF	±10%	GCJ31BR73A152KXJ1#			
			2200pF	±10%	GCJ31BR73A222KXJ1#			
			3300pF	±10%	GCJ31BR73A332KXJ1#			
			4700pF	±10%	GCJ31BR73A472KXJ1#			
			630Vdc	X7R	1000pF	±10%	GCJ31BR72J102KXJ1#	
	1500pF	±10%	GCJ31BR72J152KXJ1#					
	2200pF	±10%	GCJ31BR72J222KXJ1#					
	3300pF	±10%	GCJ31BR72J332KXJ1#					
	4700pF	±10%	GCJ31BR72J472KXJ1#					
	6800pF	±10%	GCJ31BR72J682KXJ1#					
	250Vdc	X7R	10000pF	±10%	GCJ31BR72J103KXJ1#			
			15000pF	±10%	GCJ31BR72E153KXJ1#			
			22000pF	±10%	GCJ31BR72E223KXJ1#			
			68000pF	±10%	GCJ31BR72E683KXJ1#			
			1.35mm	100Vdc	X7R	0.15μF	±10%	GCJ31MR72A154KA01#
			0.18μF			±10%	GCJ31MR72A184KA01#	
	0.22μF	±10%	GCJ31MR72A224KA01#					
1.35mm	50Vdc	X7R	0.15μF	±10%	GCJ31MR71H154KA01#			
			0.18μF	±10%	GCJ31MR71H184KA01#			
			0.22μF	±10%	GCJ31MR71H224KA01#			
			0.27μF	±10%	GCJ31MR71H274KA01#			
			0.33μF	±10%	GCJ31MR71H334KA01#			
			0.39μF	±10%	GCJ31MR71H394KA01#			
	25Vdc	X7R	0.47μF	±10%	GCJ31MR71H474KA01#			
			0.56μF	±10%	GCJ31MR71H564KA12#			
			0.68μF	±10%	GCJ31MR71H684KA12#			
			0.82μF	±10%	GCJ31MR71H824KA12#			
			1.0μF	±10%	GCJ31MR71H105KA12#			
			0.10μF	±10%	GCJ31MR71E104KA01#			
25Vdc	X7R	0.12μF	±10%	GCJ31MR71E124KA01#				
		0.15μF	±10%	GCJ31MR71E154KA01#				
		0.18μF	±10%	GCJ31MR71E184KA01#				

T max.	Rated Voltage	TC Code	Cap.	Tol.	Part Number			
1.35mm	25Vdc	X7R	0.22μF	±10%	GCJ31MR71E224KA01#			
			1.0μF	±10%	GCJ31MR71E105KA01#			
			1.5μF	±10%	GCJ31MR71E155KA12#			
			2.2μF	±10%	GCJ31MR71E225KA12#			
			3.3μF	±10%	GCJ31MR71E335KA12#			
	16Vdc	X7R	1.0μF	±10%	GCJ31MR71C105KA01#			
			1.5μF	±10%	GCJ31MR71C155KA01#			
			1.8mm	1000Vdc	X7R	6800pF	±10%	GCJ31CR73A682KXJ3#
			10000pF			±10%	GCJ31CR73A103KXJ3#	
			630Vdc			X7R	15000pF	±10%
22000pF	±10%	GCJ31CR72J223KXJ3#						
250Vdc	X7R	33000pF	±10%	GCJ31CR72E333KXJ3#				
47000pF		±10%	GCJ31CR72E473KXJ3#					
0.10μF		±10%	GCJ31CR72E104KXJ3#					
1.9mm	100Vdc	X7R	1.0μF	±10%	GCJ31CR72A105KA01#			
			50Vdc	X7R	1.5μF	±10%	GCJ31CR71H155KA12#	
					2.2μF	±10%	GCJ31CR71H225KA12#	
	35Vdc	X8L	4.7μF	±10%	GCJ31CC71H475KA01#			
			0.56μF	±10%	GCJ31CL8YA564KA01#			
			0.68μF	±10%	GCJ31CL8YA684KA01#			
			0.82μF	±10%	GCJ31CL8YA824KA01#			
	25Vdc	X8L	1.0μF	±10%	GCJ31CL8YA105KA01#			
			0.56μF	±10%	GCJ31CL81E564KA01#			
			0.68μF	±10%	GCJ31CL81E684KA01#			
0.82μF			±10%	GCJ31CL81E824KA01#				
1.0μF			±10%	GCJ31CL81E105KA01#				
4.7μF			±10%	GCJ31CR71E475KA12#				
16Vdc	X8L	3.3μF	±10%	GCJ31CL81C335KA01#				
		4.7μF	±10%	GCJ31CL81C475KA01#				
	X7R	3.3μF	±10%	GCJ31CR71C335KA01#				
		4.7μF	±10%	GCJ31CR71C475KA01#				
10Vdc	X7R	10μF	±10%	GCJ31CR71C106KA15#				
		6.8μF	±10%	GCJ31CR71A685KA13#				
		10μF	±10%	GCJ31CR71A106KA13#				
6.3Vdc	X7R	22μF	±10%	GCJ31CR70J226KE01#				
2.0mm	25Vdc	X7S	10μF	±10%	GCJ31CC71E106KA15#			

■ 3.2x2.5mm

T max.	Rated Voltage	TC Code	Cap.	Tol.	Part Number		
1.5mm	630Vdc	X7R	6800pF	±10%	GCJ32QR72J682KXJ1#		
			10000pF	±10%	GCJ32QR72J103KXJ1#		
	250Vdc	X7R	68000pF	±10%	GCJ32QR72E683KXJ1#		
0.15μF	±10%		GCJ32QR72E154KXJ1#				
2.0mm	1000Vdc	X7R	15000pF	±10%	GCJ32DR73A153KXJ1#		
			22000pF	±10%	GCJ32DR73A223KXJ1#		
			630Vdc	X7R	15000pF	±10%	GCJ32DR72J153KXJ1#
			22000pF		±10%	GCJ32DR72J223KXJ1#	
	33000pF	±10%	GCJ32DR72J333KXJ1#				
	47000pF	±10%	GCJ32DR72J473KXJ1#				
	250Vdc	X7R	0.10μF	±10%	GCJ32DR72E104KXJ1#		
			0.22μF	±10%	GCJ32DR72E224KXJ1#		
2.3mm			100Vdc	X7R	2.2μF	±10%	GCJ32DR72A225KA01#

Part number # indicates the package specification code.

GCJ Series High Dielectric Constant Type AEC-Q200 Fail safe Deflecting crack Part Number List

(→ ■ 3.2×2.5mm)

T max.	Rated Voltage	TC Code	Cap.	Tol.	Part Number
2.8mm	50Vdc	X7R	4.7μF	±10%	GCJ32ER71H475KA12#
		X7S	10μF	±10%	GCJ32EC71H106KA01#
	25Vdc	X8L	4.7μF	±10%	GCJ32EL81E475KA01#
	16Vdc	X7R	22μF	±10%	GCJ32ER71C226KE01#
	6.3Vdc	X7R	47μF	±10%	GCJ32ER70J476KE01#

■ 4.5×3.2mm

T max.	Rated Voltage	TC Code	Cap.	Tol.	Part Number
1.5mm	630Vdc	X7R	68000pF	±10%	GCJ43QR72J683KXJ1#
	250Vdc	X7R	0.15μF	±10%	GCJ43QR72E154KXJ1#
2.0mm	1000Vdc	X7R	33000pF	±10%	GCJ43DR73A333KXJ1#
			47000pF	±10%	GCJ43DR73A473KXJ1#
	630Vdc	X7R	33000pF	±10%	GCJ43DR72J333KXJ1#
			47000pF	±10%	GCJ43DR72J473KXJ1#
			0.10μF	±10%	GCJ43DR72J104KXJ1#
	250Vdc	X7R	0.22μF	±10%	GCJ43DR72E224KXJ1#
			0.33μF	±10%	GCJ43DR72E334KXJ1#
			0.47μF	±10%	GCJ43DR72E474KXJ1#

■ 5.7×5.0mm

T max.	Rated Voltage	TC Code	Cap.	Tol.	Part Number
2.0mm	1000Vdc	X7R	68000pF	±10%	GCJ55DR73A683KXJ1#
			0.10μF	±10%	GCJ55DR73A104KXJ1#
	630Vdc	X7R	0.10μF	±10%	GCJ55DR72J104KXJ1#
			0.15μF	±10%	GCJ55DR72J154KXJ1#
			0.22μF	±10%	GCJ55DR72J224KXJ1#
	250Vdc	X7R	0.33μF	±10%	GCJ55DR72E334KXJ1#
			0.47μF	±10%	GCJ55DR72E474KXJ1#
			0.68μF	±10%	GCJ55DR72E684KXJ1#
			1.0μF	±10%	GCJ55DR72E105KXJ1#

GCM Series

GCD Series

GCE Series

GCG Series

GCJ Series

GC3 Series

KCM Series

KC3 Series

⚠Caution/Notice

High Effective Capacitance & High Allowable Ripple Current

GC3 Series  **AEC-Q200** **Anti-noise**

This is a high ripple resistance product for automobiles, excellent in DC voltage characteristics.

Features

- 1 When a DC voltage is applied, a capacitance higher than conventional products (X7R characteristics) can be acquired.

When DC600V is applied, about twice the capacitance can be secured.

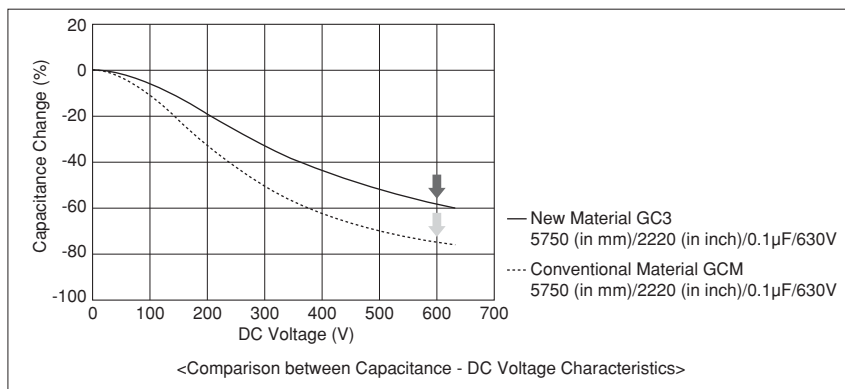

- 2 Improved ripple resistance performance compared to conventional products (X7R characteristics).

In the case of a product with a capacitance of 0.1μF, when the exothermic temperature reaches 20°C at frequency f=300kHz, the amount of resistance of a product with conventional material is 1.8Arms; however, the new material is 2.3 Arms.

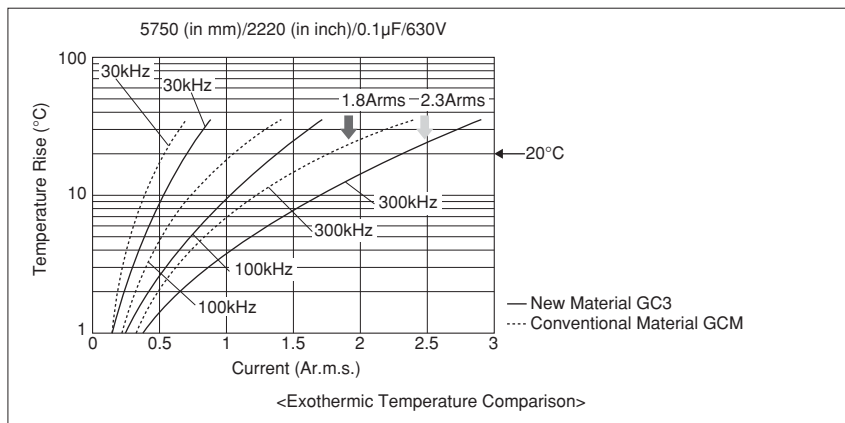

- 3 This product has a noise reduction effect.

Since dielectric materials that enable a reduction of noise are used, this product is more effective for reducing noise compared to the GCM series for automobiles.

Specifications

Size	2.0×1.25mm to 5.7×5.0mm
Rated Voltage	250Vdc to 630Vdc
Capacitance	10000pF to 1.0μF
Main Applications	For PFC (Power Factor Correction) circuits of power supplies, EMI suppression, and smoothing circuits of automobiles

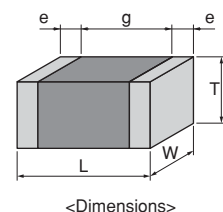

GCM Series
 GCD Series
 GCE Series
 GCG Series
 GCJ Series
GC3 Series
 KCM Series
 KC3 Series
 ⚠Caution/Notice

GC3 Series High Dielectric Constant Type AEC-Q200 Anti-noise Part Number List

■ 2.0×1.25mm

T max.	Rated Voltage	TC Code	Cap.	Tol.	Part Number
1.0mm	250Vdc	X7T	10000pF	±10%	GC321AD72E103KX01#
			15000pF	±10%	GC321AD72E153KX01#
1.45mm	250Vdc	X7T	22000pF	±10%	GC321BD72E223KX03#

T max.	Rated Voltage	TC Code	Cap.	Tol.	Part Number
2.7mm	630Vdc	X7T	0.27μF	±10%	GC355XD72J274KX05#
	450Vdc	X7T	0.56μF	±10%	GC355XD72W564KX05#
	250Vdc	X7T	1.0μF	±10%	GC355XD72E105KX05#

■ 3.2×1.6mm

T max.	Rated Voltage	TC Code	Cap.	Tol.	Part Number
1.0mm	450Vdc	X7T	10000pF	±10%	GC331AD72W103KX01#
			15000pF	±10%	GC331AD72W153KX01#
	250Vdc	X7T	33000pF	±10%	GC331AD72E333KX01#
1.25mm	630Vdc	X7T	10000pF	±10%	GC331BD72J103KX01#
	450Vdc	X7T	22000pF	±10%	GC331BD72W223KX01#
			33000pF	±10%	GC331BD72W333KX01#
250Vdc	X7T	47000pF	±10%	GC331BD72E473KX01#	
1.8mm	630Vdc	X7T	15000pF	±10%	GC331CD72J153KX03#
	450Vdc	X7T	47000pF	±10%	GC331CD72W473KX03#
	250Vdc	X7T	68000pF	±10%	GC331CD72E683KX03#

■ 3.2×2.5mm

T max.	Rated Voltage	TC Code	Cap.	Tol.	Part Number
1.5mm	630Vdc	X7T	22000pF	±10%	GC332QD72J223KX01#
	250Vdc	X7T	0.10μF	±10%	GC332QD72E104KX01#
2.0mm	630Vdc	X7T	33000pF	±10%	GC332DD72J333KX01#
			47000pF	±10%	GC332DD72J473KX01#
	450Vdc	X7T	68000pF	±10%	GC332DD72W683KX01#
			0.10μF	±10%	GC332DD72W104KX01#
			0.15μF	±10%	GC332DD72E154KX01#

■ 4.5×3.2mm

T max.	Rated Voltage	TC Code	Cap.	Tol.	Part Number
1.5mm	250Vdc	X7T	0.22μF	±10%	GC343QD72E224KX01#
2.0mm	630Vdc	X7T	68000pF	±10%	GC343DD72J683KX01#
	450Vdc	X7T	0.15μF	±10%	GC343DD72W154KX01#
	250Vdc	X7T	0.33μF	±10%	GC343DD72E334KX01#

■ 5.7×5.0mm

T max.	Rated Voltage	TC Code	Cap.	Tol.	Part Number
2.0mm	630Vdc	X7T	0.10μF	±10%	GC355DD72J104KX01#
			0.15μF	±10%	GC355DD72J154KX01#
	450Vdc	X7T	0.22μF	±10%	GC355DD72W224KX01#
			0.33μF	±10%	GC355DD72W334KX01#
			0.47μF	±10%	GC355DD72W474KX01#
	250Vdc	X7T	0.47μF	±10%	GC355DD72E474KX01#
0.68μF			±10%	GC355DD72E684KX01#	
2.7mm	630Vdc	X7T	0.22μF	±10%	GC355XD72J224KX05#

Part number # indicates the package specification code.

Metal Terminal Type

KCM Series



AEC-Q200

Anti-noise

Deflecting crack

Soldering crack

By bonding metal terminals to the external electrodes of the chip, the problem of how to design a capacitor to enable it to be mounted on a large MLCC has been solved!

Features

① Bond the metal terminals to the external electrodes of the chip.

The stress on the chip is reduced due to the elastic behavior of the metal terminals.

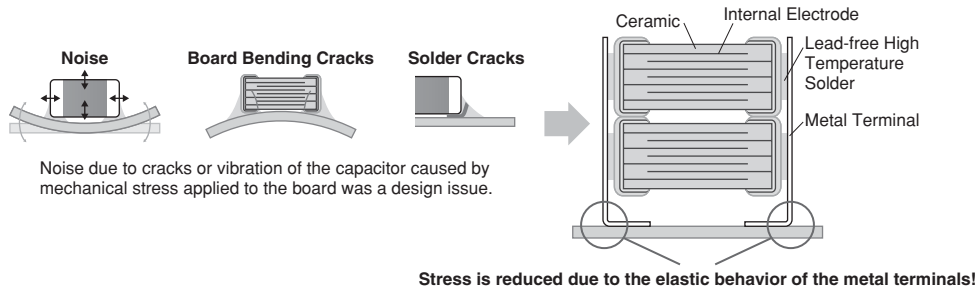

② Noise, board deflection cracks, and solder cracks are greatly reduced.

No breakage occurs even when the board deflection is 6mm.
 Solder cracks were not found even after 2000 heat stress cycles.

Comparison of Noise Reduction Effect

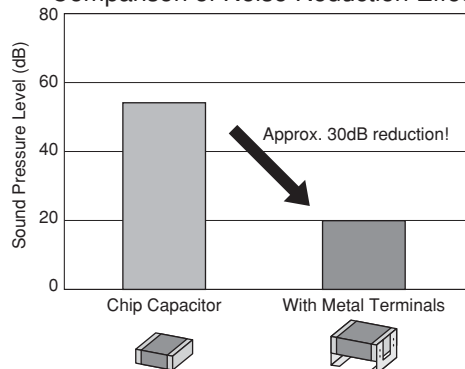

Evaluation Items: 2220 size/DC630V/220nF
 Test Conditions: 50V, AC10Vp-p/3kHz
 Sample Board: Glass-epoxy Board (T: 1.6mm)
 Number of samples: 3
 Distance between microphone and board: 3mm

Note: Results obtained using Murata's evaluation board

Stress caused by board deflection is reduced.

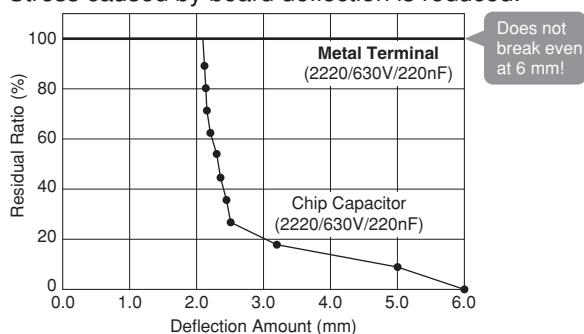

Solder cracks due to heat stress are reduced.

Chip Size	Individual Chip (2220 size)		Metal Terminal (2220 size)	
1000 cycles				
2000 cycles				

Compared to an individual chip, the addition of metal terminals results in excellent solder cracking resistance.

Test Conditions: -55 to +125°C, 5 minutes (liquid phase)
 Board used: Glass-epoxy Board (FR-4)

③ Chip Stacking

A large capacitance can be realized by stacking two capacitors on top of each other.

Specifications

Size	6.1×5.3mm
Rated Voltage	25Vdc to 100Vdc
Capacitance	4.7μF to 68μF
Main Applications	For drive control of engine ECU, etc. For other drive system control and safety equipment

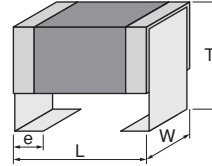

<Dimensions>

GCM Series

GCD Series

GCE Series

GCG Series

G CJ Series

GC3 Series

KCM Series

KC3 Series

⚠Caution/Notice

KCM Series High Dielectric Constant Type AEC-Q200 Anti-noise Deflecting crack Soldering crack Part Number List

■ 6.1×5.3mm

T max.	Rated Voltage	TC Code	Cap.	Tol.	Part Number
3.0mm	100Vdc	X7R	4.7μF	±10%	KCM55LR72A475KH01#
	63Vdc	X7R	4.7μF	±10%	KCM55LR71J475KH01#
	50Vdc	X7R	4.7μF	±10%	KCM55LR71H475KH01#
			10μF	±10%	KCM55LR71H106KH01#
	35Vdc	X7R	10μF	±10%	KCM55LR7YA106KH01#
			15μF	±10%	KCM55LR7YA156KH01#
25Vdc	X7R	15μF	±10%	KCM55LR71E156KH01#	
3.9mm	100Vdc	X7R	6.8μF	±10%	KCM55QR72A685KH01#
	63Vdc	X7R	10μF	±10%	KCM55QR71J106KH01#
	50Vdc	X7R	17μF	±10%	KCM55QR71H176KH01#
			35Vdc	X7R	17μF
	25Vdc	X7R	22μF	±10%	KCM55QR7YA226KH01#
			22μF	±10%	KCM55QR71E226KH01#
33μF			±10%	KCM55QR71E336KH01#	
5.0mm	100Vdc	X7R	10μF	±20%	KCM55TR72A106MH01#
	50Vdc	X7R	22μF	±20%	KCM55TR71H226MH01#
	35Vdc	X7R	22μF	±20%	KCM55TR7YA226MH01#
			33μF	±20%	KCM55TR7YA336MH01#
	25Vdc	X7R	33μF	±20%	KCM55TR71E336MH01#
6.7mm	100Vdc	X7R	15μF	±20%	KCM55WR72A156MH01#
	63Vdc	X7R	22μF	±20%	KCM55WR71J226MH01#
	50Vdc	X7R	33μF	±20%	KCM55WR71H336MH01#
	35Vdc	X7R	47μF	±20%	KCM55WR7YA476MH01#
	25Vdc	X7R	47μF	±20%	KCM55WR71E476MH01#
			68μF	±20%	KCM55WR71E686MH01#

GCM Series

GCD Series

GCE Series

GCG Series

GCJ Series

GC3 Series

KCM Series

KC3 Series

⚠Caution/Notice

Metal Terminal Type/High Effective Capacitance & High Allowable Ripple Current

KC3 Series



- AEC-Q200
- Anti-noise
- Deflecting crack
- Soldering crack

By bonding metal terminals to the external electrodes of the chip, the problem of how to design a capacitor to enable it to be mounted on a large MLCC has been solved!

Features

① Bond the metal terminals to the external electrodes of the chip.

The stress on the chip is reduced due to the elastic behavior of the metal terminals.

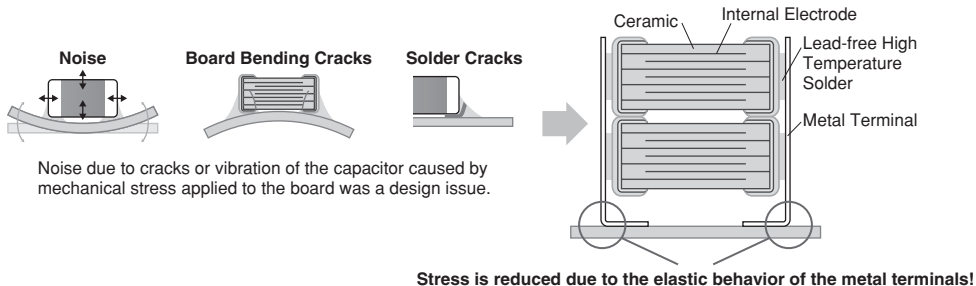

② Noise, board deflection cracks, and solder cracks are greatly reduced.

No breakage occurs even when the board deflection is 6mm.
 Solder cracks were not found even after 2000 heat stress cycles.

Comparison of Noise Reduction Effect

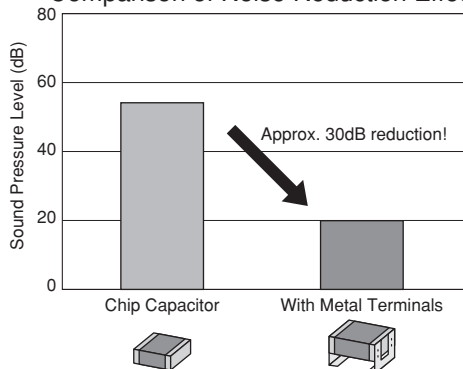

Evaluation Items: 2220 size/DC630V/220nF
 Test Conditions: 50V, AC10Vp-p/3kHz
 Sample Board: Glass-epoxy Board (T: 1.6mm)
 Number of samples: 3
 Distance between microphone and board: 3mm

Note: Results obtained using Murata's evaluation board

Stress caused by board deflection is reduced.

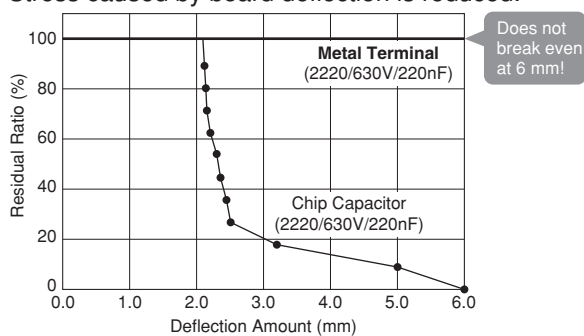

Solder cracks due to heat stress are reduced.

Chip Size	Individual Chip (2220 size)		Metal Terminal (2220 size)	
1000 cycles				
2000 cycles				

Compared to an individual chip, the addition of metal terminals results in excellent solder cracking resistance.

Test Conditions: -55 to +125°C, 5 minutes (liquid phase)
 Board used: Glass-epoxy Board (FR-4)

GCM Series

GCD Series

GCE Series

GCG Series

GCM Series

GCM Series

KCM Series

KC3 Series

⚠Caution/Notice

3 Uses material of low dielectric constant.

Compared to a conventional capacitor (X7R characteristics), this series has higher effective capacitance and better anti-ripple performance.

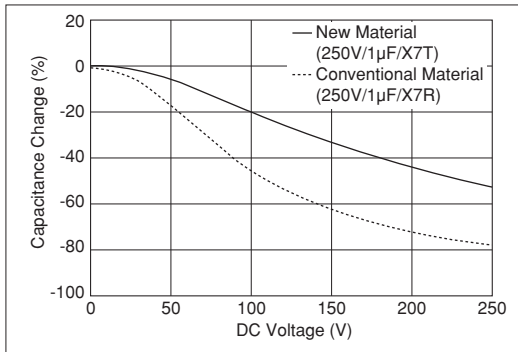

4 Chip Stacking

A large capacitance can be realized by stacking two capacitors on top of each other.

Specifications

Size	6.1×5.3mm
Rated Voltage	250Vdc to 630Vdc
Capacitance	0.1µF to 2.2µF
Main Applications	For drive control of engine ECU, etc. For other drive system control and safety equipment

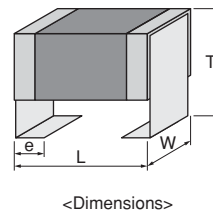

GCM Series

GCD Series

GCE Series

GCG Series

GCI Series

GCI Series

KCM Series

KCI Series

⚠Caution/Notice

KC3 Series High Dielectric Constant Type AEC-Q200 Anti-noise Deflecting crack Soldering crack Part Number List

■ 6.1×5.3mm

T max.	Rated Voltage	TC Code	Cap.	Tol.	Part Number
3.0mm	630Vdc	X7T	0.10μF	±10%	KC355LD72J104KH01#
			0.15μF	±10%	KC355LD72J154KH01#
	450Vdc	X7T	0.22μF	±10%	KC355LD72W224KH01#
			0.33μF	±10%	KC355LD72W334KH01#
			0.47μF	±10%	KC355LD72W474KH01#
	250Vdc	X7T	0.47μF	±10%	KC355LD72E474KH01#
0.68μF			±10%	KC355LD72E684KH01#	
3.9mm	630Vdc	X7T	0.22μF	±10%	KC355QD72J224KH01#
			0.27μF	±10%	KC355QD72J274KH01#
	450Vdc	X7T	0.56μF	±10%	KC355QD72W564KH01#
			1.0μF	±10%	KC355QD72E105KH01#
5.0mm	450Vdc	X7T	0.68μF	±20%	KC355TD72W684MH01#
			1.0μF	±20%	KC355TD72W105MH01#
	250Vdc	X7T	1.5μF	±20%	KC355TD72E155MH01#
6.7mm	630Vdc	X7T	0.47μF	±20%	KC355WD72J474MH01#
			0.56μF	±20%	KC355WD72J564MH01#
	450Vdc	X7T	1.2μF	±20%	KC355WD72W125MH01#
	250Vdc	X7T	2.2μF	±20%	KC355WD72E225MH01#

GCM Series

GCD Series

GCE Series

GCG Series

GCJ Series

GC3 Series

KCM Series

KC3 Series

⚠Caution/Notice

For Automotive

⚠Caution/Notice

⚠Caution

■ Storage and Operation Conditions	47
■ Rating	47
1. Temperature Dependent Characteristics	47
2. Measurement of Capacitance	47
3. Applied Voltage	48
4. Type of Applied Voltage and Self-heating Temperature	48
5. DC Voltage and AC Voltage Characteristics	50
6. Capacitance Aging	50
7. Vibration and Shock	51
■ Soldering and Mounting	51
1. Mounting Position	51
2. Information before Mounting	52
3. Maintenance of the Mounting (pick and place) Machine	52
4-1. Reflow Soldering	53
4-2. Flow Soldering	54
4-3. Correction of Soldered Portion	55
5. Washing	56
6. Electrical Test on Printed Circuit Board	56
7. Printed Circuit Board Cropping	56
8. Assembly	59
9. Selection of Conductive Adhesive, Mounting Process, and Bonding Strength	60
10. Moisture Proof Process	60
11. Application	60
■ Other	60
1. Under Operation of Equipment	60
2. Other	60

Notice

■ Rating	61
1. Operating Temperature	61
2. Atmosphere Surroundings	61
3. Piezo-electric Phenomenon	61
■ Soldering and Mounting	61
1. PCB Design	61
1. Notice for Pattern Forms	61
2. Land Dimensions	62
3. Board Design	63
2. Adhesive Application	63
3. Adhesive Curing	63
4. Flux for Reflow and Flow Soldering	64
5. Flow Soldering	64
6. Washing	64
7. Coating	64
■ Other	65
1. Transportation	65
2. Characteristics Evaluation in the Actual System	65

GCM Series

GCD Series

GCE Series

GCG Series

GCI Series

GCI Series

KCM Series

KC3 Series

⚠Caution/Notice

■ Storage and Operation Conditions

1. The performance of chip monolithic ceramic capacitors may be affected by the storage conditions.

1-1. Store the capacitors in the following conditions:

Room Temperature of +5°C to +40°C and a Relative Humidity of 20% to 70%.

(1) Sunlight, dust, rapid temperature changes, corrosive gas atmosphere, or high temperature and humidity conditions during storage may affect solderability and packaging performance.

Therefore, please maintain the storage temperature and humidity. Use the product within six months, as prolonged storage may cause oxidation of the electrodes.

(2) Please confirm solderability before using after six months. Store the capacitors without opening the original bag. Even if the storage period is short, do not exceed the specified atmospheric conditions.

1-2. Corrosive gas can react with the termination (external) electrodes or lead wires of capacitors, and result in poor solderability. Do not store the capacitors in an atmosphere consisting of corrosive gas (e.g., hydrogen sulfide, sulfur dioxide, chlorine, ammonia gas, etc.).

1-3. Due to moisture condensation caused by rapid humidity changes, or the photochemical change caused by direct sunlight on the terminal electrodes and/or the resin/epoxy coatings, the solderability and electrical performance may deteriorate. Do not store capacitors under direct sunlight or in high humidity conditions.

<Applicable to GCG Series>

1-4. After unpacking, immediately reseal, or store in a desiccator containing a desiccant.

■ Rating

1. Temperature Dependent Characteristics

1. The electrical characteristics of a capacitor can change with temperature.

1-1. For capacitors having larger temperature dependency, the capacitance may change with temperature changes.

The following actions are recommended in order to ensure suitable capacitance values.

(1) Select a suitable capacitance for the operating temperature range.

(2) The capacitance may change within the rated temperature.

When you use a high dielectric constant type capacitor in a circuit that needs a tight (narrow) capacitance tolerance (e.g., a time-constant circuit), please carefully consider the temperature characteristics, and carefully confirm the various characteristics in actual use conditions and the actual system.

[Typical Temperature Characteristics X7R(R7)]

Sample: 0.1μF, Rated Voltage 50VDC

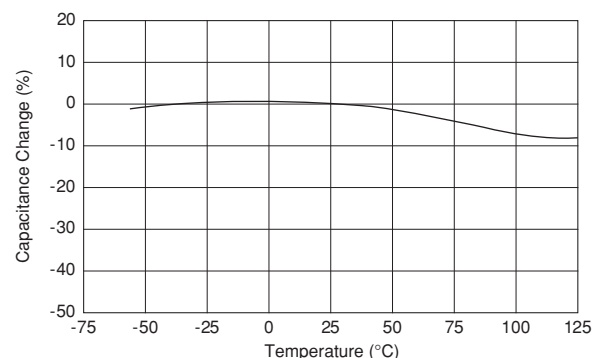

2. Measurement of Capacitance

1. Measure capacitance with the voltage and frequency specified in the product specifications.

1-1. The output voltage of the measuring equipment may decrease occasionally when capacitance is high. Please confirm whether a prescribed measured voltage is impressed to the capacitor.

1-2. The capacitance values of high dielectric constant type capacitors change depending on the AC voltage applied. Please consider the AC voltage characteristics when selecting a capacitor to be used in an AC circuit.

Continued on the following page. ↗

⚠Caution

☐ Continued from the preceding page.

3. Applied Voltage

1. Do not apply a voltage to the capacitor that exceeds the rated voltage as called out in the specifications.
 - 1-1. Applied voltage between the terminals of a capacitor shall be less than or equal to the rated voltage.
 - (1) When AC voltage is superimposed on DC voltage, the zero-to-peak voltage shall not exceed the rated DC voltage.
 When AC voltage or pulse voltage is applied, the peak-to-peak voltage shall not exceed the rated DC voltage.
 - (2) Abnormal voltages (surge voltage, static electricity, pulse voltage, etc.) shall not exceed the rated DC voltage.

Typical Voltage Applied to the DC Capacitor

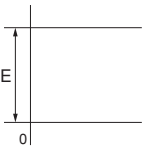
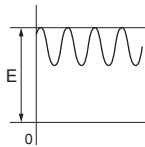
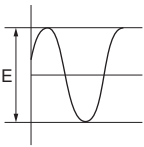
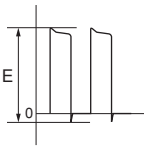
DC Voltage	DC Voltage+AC	AC Voltage	Pulse Voltage
			

(E: Maximum possible applied voltage.)

1-2. Influence of over voltage

Over voltage that is applied to the capacitor may result in an electrical short circuit caused by the breakdown of the internal dielectric layers.

The time duration until breakdown depends on the applied voltage and the ambient temperature.

2. Use a safety standard certified capacitor in a power supply input circuit (AC filter), as it is also necessary to consider the withstand voltage and impulse withstand voltage defined for each device.

4. Type of Applied Voltage and Self-heating Temperature

1. Confirm the operating conditions to make sure that no large current is flowing into the capacitor due to the continuous application of an AC voltage or pulse voltage.

When a DC rated voltage product is used in an AC voltage circuit or a pulse voltage circuit, the AC current or pulse current will flow into the capacitor; therefore check the self-heating condition.

Please confirm the surface temperature of the capacitor so that the temperature remains within the upper limits of the operating temperature, including the rise in temperature due to self-heating. When the capacitor is used with a high-frequency voltage or pulse voltage, heat may be generated by dielectric loss.

<Applicable to Rated Voltage of less than 100VDC>

- 1-1. The load should be contained to the level such that when measuring at atmospheric temperature of 25°C, the product's self-heating remains below 20°C and the surface temperature of the capacitor in the actual circuit remains within the maximum operating temperature.

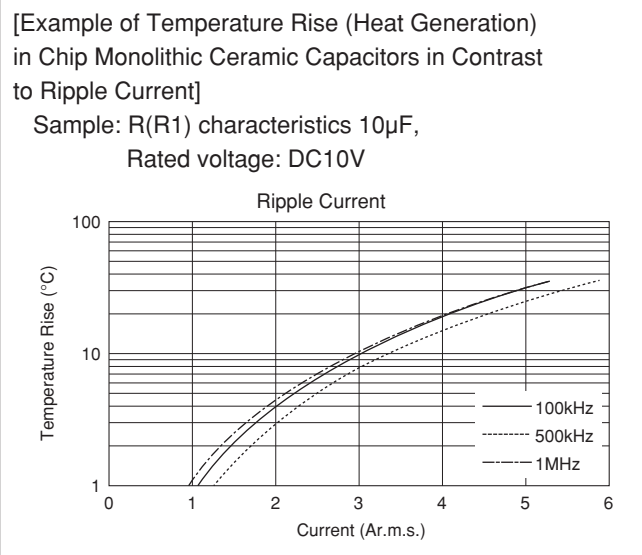

GCM Series
GCD Series
GCE Series
GCG Series
GCJ Series
GC3 Series
KCM Series
KC3 Series

↳ Continued from the preceding page.

<Applicable to Temperature Characteristics X7R(R7), X7T(D7) beyond Rated Voltage of 250VDC>

1-2. The load should be contained so that the self-heating of the capacitor body remains below 20°C, when measuring at an ambient temperature of 25°C. In addition, use a K thermocouple of ø0.1mm with less heat capacity when measuring, and measure in a condition where there is no effect from the radiant heat of other components or air flow caused by convection. Excessive generation of heat may cause deterioration of the characteristics and reliability of the capacitor. (Absolutely do not perform measurements while the cooling fan is operating, as an accurate measurement may not be performed.)

<Applicable to Temperature Characteristics U2J(7U) beyond Rated Voltage of 250VDC>

1-3. Since the self-heating is low in the low loss series, the allowable power becomes extremely high compared to the common X7R(R7) characteristics. However, when a load with self-heating of 20°C is applied at the rated voltage, the allowable power may be exceeded. When the capacitor is used in a high-frequency voltage circuit of 1kHz or more, the frequency of the applied voltage should be less than 500kHz sine wave (less than 100kHz for a product with rated voltage of DC3.15kV), to limit the voltage load so that the load remains within the derating shown in the following figure. In the case of non-sine wave, high-frequency components exceeding the fundamental frequency may be included. In such a case, please contact Murata. The excessive generation of heat may cause deterioration of the characteristics and reliability of the capacitor. (Absolutely do not perform measurements while the cooling fan is operating, as an accurate measurement may not be performed.)

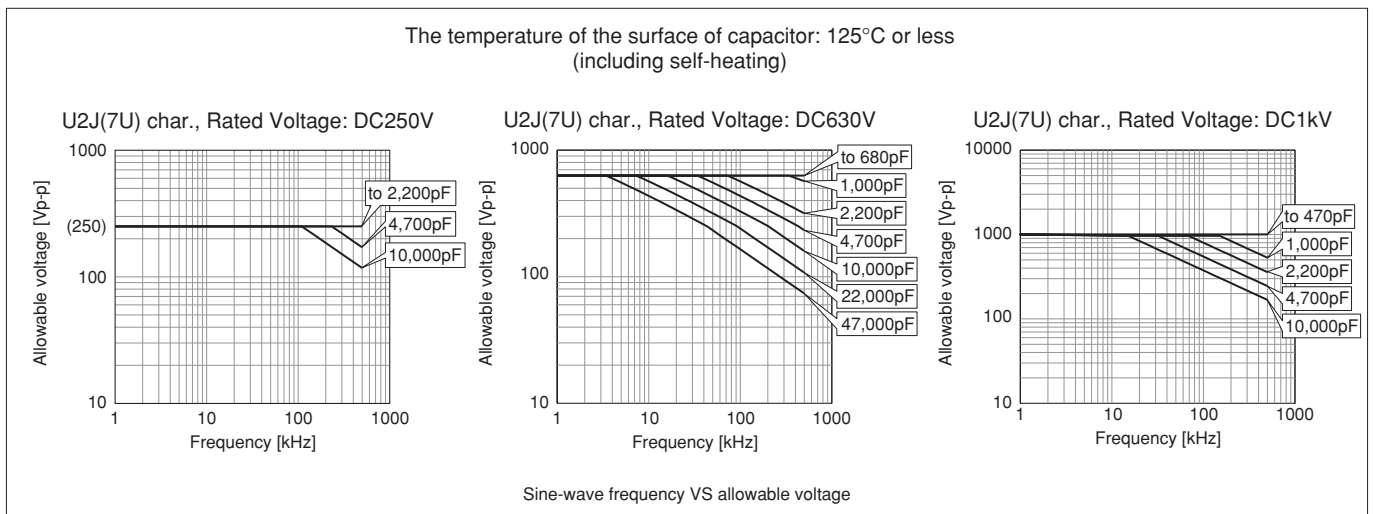

<Design Tool>

• Simsurfing

Simsurfing is a web application to display the characteristics charts and download the characteristics data of our products. The frequency characteristics, temperature characteristics, bias characteristics etc. can be checked.

(Address: <http://www.murata.com/simsurfing/>)

• Medium Voltage Ceramic Capacitor Selection Tool

The selection tool "Murata Medium Voltage Capacitors Selection Tool by Voltage Form" is installed in the above SimSurfing, where the usability of the preferred medium voltage ceramic capacitors can be determined according to the application including automobiles.

By using this tool, the preferred products* can be checked by specifications, such as the power, voltage, and fundamental frequency of the voltage waveform to be input into the capacitor.

*Supported Series

Temperature characteristics U2J(7U) of GCM/DC250V or more

Continued on the following page. ↗

⚠Caution

☐ Continued from the preceding page.

5. DC Voltage and AC Voltage Characteristics

1. The capacitance value of a high dielectric constant type capacitor changes depending on the DC voltage applied. Please consider the DC voltage characteristics when a capacitor is selected for use in a DC circuit.

1-1. The capacitance of ceramic capacitors may change sharply depending on the applied voltage (see figure).

Please confirm the following in order to secure the capacitance.

- (1) Determine whether the capacitance change caused by the applied voltage is within the allowed range.
- (2) In the DC voltage characteristics, the rate of capacitance change becomes larger as voltage increases, even if the applied voltage is below the rated voltage. When a high dielectric constant type capacitor is used in a circuit that requires a tight (narrow) capacitance tolerance (e.g., a time constant circuit), please carefully consider the voltage characteristics, and confirm the various characteristics in actual operating conditions in an actual system.

2. The capacitance values of high dielectric constant type capacitors changes depending on the AC voltage applied. Please consider the AC voltage characteristics when selecting a capacitor to be used in an AC circuit.

[DC Voltage Characteristics]
 Sample: R(R1) Characteristics 0.1μF,
 Rated Voltage 50VDC

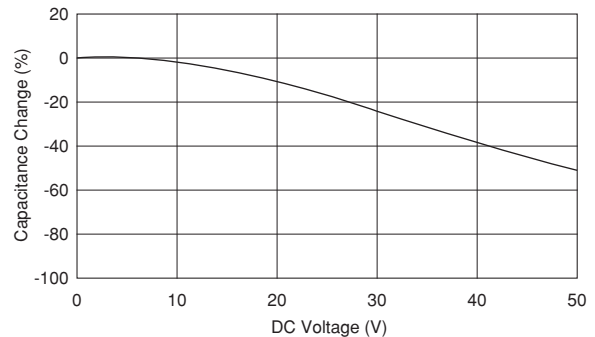

[AC Voltage Characteristics]
 Sample: X7R(R7) Characteristics 10μF,
 Rated Voltage 6.3VDC

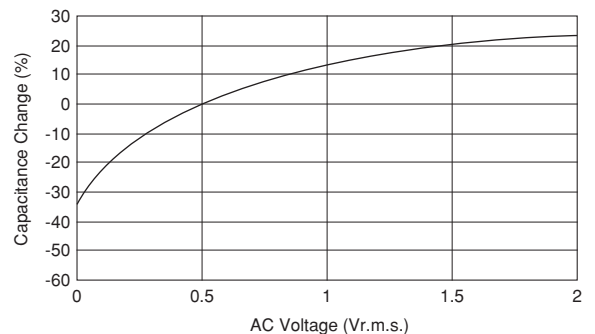

6. Capacitance Aging

1. The high dielectric constant type capacitors have the Characteristics in which the capacitance value decreases with the passage of time.

When you use high dielectric constant type capacitors in a circuit that needs a tight (narrow) capacitance tolerance (e.g., a time-constant circuit), please carefully consider the characteristics of these capacitors, such as their aging, voltage, and temperature characteristics. In addition, check capacitors using your actual appliances at the intended environment and operating conditions.

[Example of Change Over Time (Aging Characteristics)]

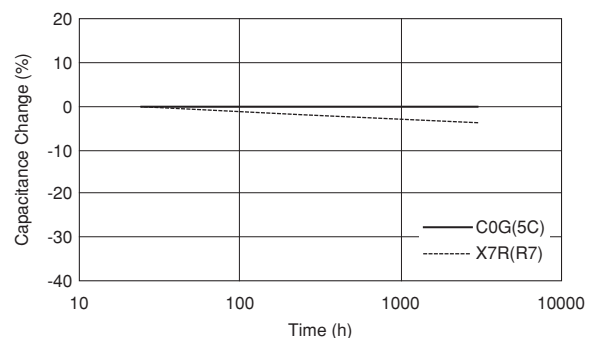

Continued on the following page. ↗

GCM Series

GCD Series

GCE Series

GCG Series

GCI Series

GCS Series

KCM Series

KCS Series

⚠Caution

↳ Continued from the preceding page.

7. Vibration and Shock

1. Please confirm the kind of vibration and/or shock, its condition, and any generation of resonance.
Please mount the capacitor so as not to generate resonance, and do not allow any impact on the terminals.
2. Mechanical shock due to being dropped may cause damage or a crack in the dielectric material of the capacitor.
Do not use a dropped capacitor because the quality and reliability may be deteriorated.
3. When printed circuit boards are piled up or handled, the corner of another printed circuit board should not be allowed to hit the capacitor, in order to avoid a crack or other damage to the capacitor.

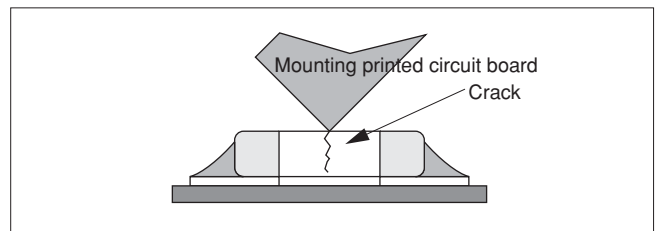
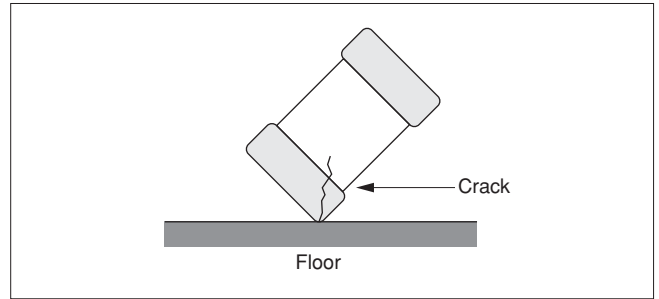

■ Soldering and Mounting

1. Mounting Position

1. Confirm the best mounting position and direction that minimizes the stress imposed on the capacitor during flexing or bending the printed circuit board.
 - 1-1. Choose a mounting position that minimizes the stress imposed on the chip during flexing or bending of the board.

[Component Direction]

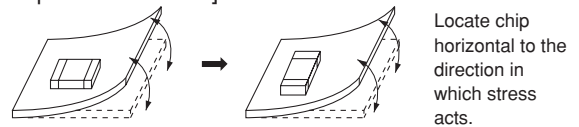

[Chip Mounting Close to Board Separation Point]

It is effective to implement the following measures, to reduce stress in separating the board.
It is best to implement all of the following three measures; however, implement as many measures as possible to reduce stress.

Contents of Measures	Stress Level
(1) Turn the mounting direction of the component parallel to the board separation surface.	A > D
(2) Add slits in the board separation part.	A > B
(3) Keep the mounting position of the component away from the board separation surface.	A > C

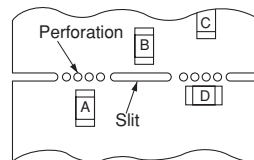

[Mounting Capacitors Near Screw Holes]

When a capacitor is mounted near a screw hole, it may be affected by the board deflection that occurs during the tightening of the screw. Mount the capacitor in a position as far away from the screw holes as possible.

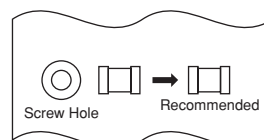

Continued on the following page. ↗

⚠Caution

☐ Continued from the preceding page.

2. Information before Mounting

1. Do not re-use capacitors that were removed from the equipment.
2. Confirm capacitance characteristics under actual applied voltage.
3. Confirm the mechanical stress under actual process and equipment use.
4. Confirm the rated capacitance, rated voltage and other electrical characteristics before assembly.
5. Prior to use, confirm the solderability of capacitors that were in long-term storage.
6. Prior to measuring capacitance, carry out a heat treatment for capacitors that were in long-term storage.
7. The use of Sn-Zn based solder will deteriorate the reliability of the MLCC.

Please contact our sales representative or product engineers on the use of Sn-Zn based solder in advance.

8. We have also produced a DVD which shows a summary of our opinions, regarding the precautions for mounting. Please contact our sales representative to request the DVD.

3. Maintenance of the Mounting (pick and place) Machine

1. Make sure that the following excessive forces are not applied to the capacitors.

1-1. In mounting the capacitors on the printed circuit board, any bending force against them shall be kept to a minimum to prevent them from any bending damage or cracking. Please take into account the following precautions and recommendations for use in your process.

- (1) Adjust the lowest position of the pickup nozzle so as not to bend the printed circuit board.
- (2) Adjust the nozzle pressure within a static load of 1N to 3N during mounting.

2. Dirt particles and dust accumulated between the suction nozzle and the cylinder inner wall prevent the nozzle from moving smoothly. This imposes greater force upon the chip during mounting, causing cracked chips. Also, the locating claw, when worn out, imposes uneven forces on the chip when positioning, causing cracked chips. The suction nozzle and the locating claw must be maintained, checked, and replaced periodically.

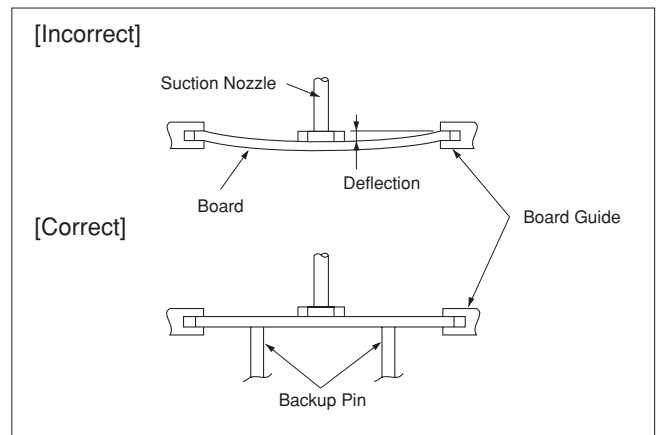

Continued on the following page. ☐

☐ Continued from the preceding page.

4-1. Reflow Soldering

- When sudden heat is applied to the components, the mechanical strength of the components will decrease because a sudden temperature change causes deformation inside the components. In order to prevent mechanical damage to the components, preheating is required for both the components and the PCB. Preheating conditions are shown in table 1. It is required to keep the temperature differential between the solder and the components surface (ΔT) as small as possible.
- Solderability of tin plating termination chips might be deteriorated when a low temperature soldering profile where the peak solder temperature is below the melting point of tin is used. Please confirm the solderability of tin plated termination chips before use.
- When components are immersed in solvent after mounting, be sure to maintain the temperature difference (ΔT) between the component and the solvent within the range shown in table 1.

Table 1

Part Number	Temperature Differential
GC3/GCD/GCE/GCJ/GCM Series 03/15/18/21/31 sizes	$\Delta T \leq 190^\circ\text{C}$
GCJ/GCM Series 32/43/55 sizes KC3/KCM Series 55 size	$\Delta T \leq 130^\circ\text{C}$

Recommended Conditions

	Pb-Sn Solder		Lead Free Solder
	Reflow	Vapor Reflow	
Peak Temperature	230 to 250°C	230 to 240°C	240 to 260°C
Atmosphere	Air	Saturated vapor of inactive solvent	Air or N ₂

Pb-Sn Solder: Sn-37Pb

Lead Free Solder: Sn-3.0Ag-0.5Cu

4. Optimum Solder Amount for Reflow Soldering

- Overly thick application of solder paste results in a excessive solder fillet height. This makes the chip more susceptible to mechanical and thermal stress on the board and may cause the chips to crack.
- Too little solder paste results in a lack of adhesive strength on the outer electrode, which may result in chips breaking loose from the PCB.
- Make sure the solder has been applied smoothly to the end surface to a height of 0.2mm* min.

Inverting the PCB

Make sure not to impose any abnormal mechanical shocks to the PCB.

[Standard Conditions for Reflow Soldering]

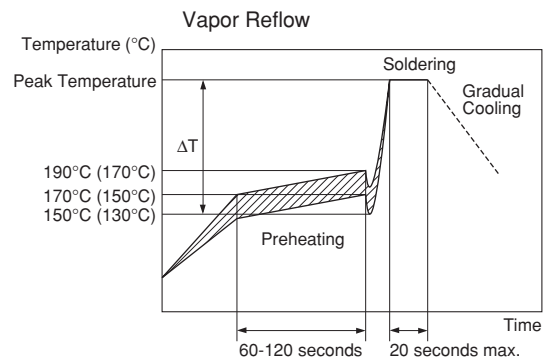
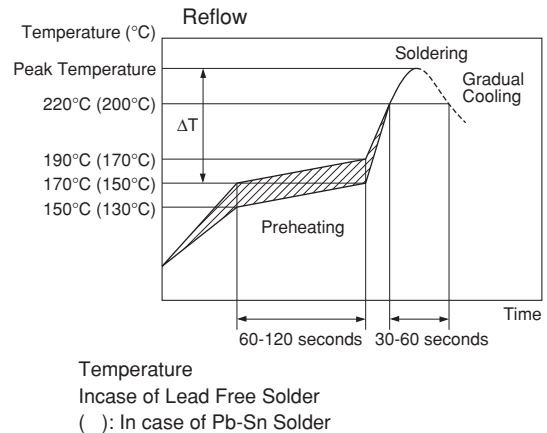

[Allowable Reflow Soldering Temperature and Time]

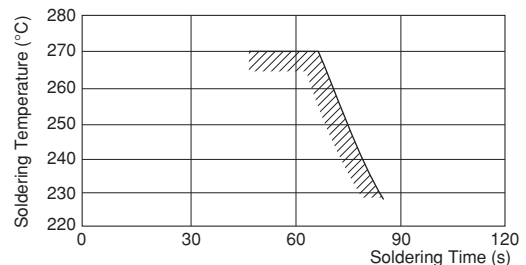

In the case of repeated soldering, the accumulated soldering time must be within the range shown above.

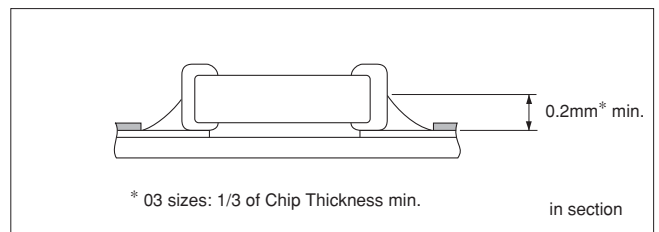

⚠Caution

☐ Continued from the preceding page.

4-2. Flow Soldering

1. Do not apply flow soldering to chips not listed in table 2.

Table 2

Part Number	Temperature Differential
GC3/GCD/GCM Series 18/21/31 sizes (Except for characteristics of X8L(L8), X8G(5G))	$\Delta T \leq 150^{\circ}\text{C}$
GCJ Series Rated Voltage 250VDC or more 18/21/31 sizes	

- When sudden heat is applied to the components, the mechanical strength of the components will decrease because a sudden temperature change causes deformation inside the components. In order to prevent mechanical damage to the components, preheating is required for both of the components and the PCB. Preheating conditions are shown in table 2. It is required to keep the temperature differential between the solder and the components surface (ΔT) as low as possible.
- Excessively long soldering time or high soldering temperature can result in leaching of the outer electrodes, causing poor adhesion or a reduction in capacitance value due to loss of contact between the electrodes and end termination.
- When components are immersed in solvent after mounting, be sure to maintain the temperature differential (ΔT) between the component and solvent within the range shown in the table 2.

Recommended Conditions

	Pb-Sn Solder	Lead Free Solder
Preheating Peak Temperature	90 to 110°C	100 to 120°C
Soldering Peak Temperature	240 to 250°C	250 to 260°C
Atmosphere	Air	Air

Pb-Sn Solder: Sn-37Pb
 Lead Free Solder: Sn-3.0Ag-0.5Cu

5. Optimum Solder Amount for Flow Soldering

5-1. The top of the solder fillet should be lower than the thickness of the components. If the solder amount is excessive, the risk of cracking is higher during board bending or any other stressful condition.

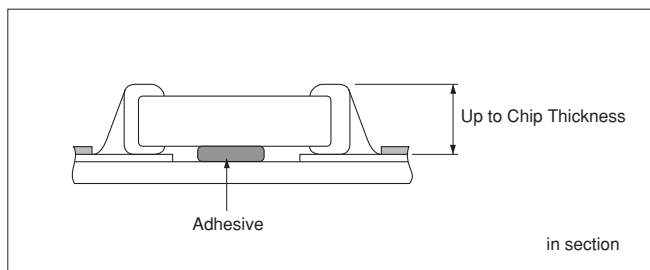
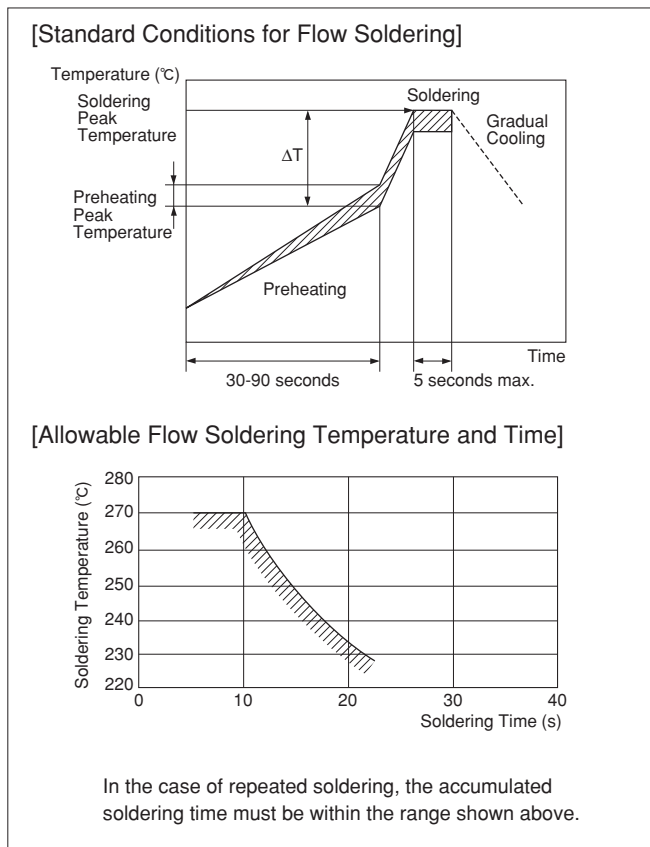

Continued on the following page. ☐

GCM Series

GCD Series

GCE Series

GCG Series

GCJ Series

GC3 Series

KCM Series

KC3 Series

⚠Caution

☐ Continued from the preceding page.

4-3. Correction of Soldered Portion

When sudden heat is applied to the capacitor, distortion caused by the large temperature difference occurs internally, and can be the cause of cracks. Capacitors also tend to be affected by mechanical and thermal stress depending on the board preheating temperature or the soldering fillet shape, and can be the cause of cracks. Please refer to "1. PCB Design" or "3. Optimum solder amount" for the solder amount and the fillet shapes.

1. Correction with a Soldering Iron

- 1-1. In order to reduce damage to the capacitor, be sure to preheat the capacitor and the mounting board. Preheat to the temperature range shown in Table 3. A hot plate, hot air type preheater, etc. can be used for preheating.
- 1-2. After soldering, do not allow the component/PCB to cool down rapidly.
- 1-3. Perform the corrections with a soldering iron as quickly as possible. If the soldering iron is applied too long, there is a possibility of causing solder leaching on the terminal electrodes, which will cause deterioration of the adhesive strength and other problems.

2. Correction with Spot Heater

Compared to local heating with a soldering iron, hot air heating by a spot heater heats the overall component and board, therefore, it tends to lessen the thermal shock. In the case of a high density mounted board, a spot heater can also prevent concerns of the soldering iron making direct contact with the component.

- 2-1. If the distance from the hot air outlet of the spot heater to the component is too close, cracks may occur due to thermal shock. To prevent this problem, follow the conditions shown in Table 4.

- 2-2. In order to create an appropriate solder fillet shape, it is recommended that hot air be applied at the angle shown in Figure 1.

3. Optimum solder amount when re-working with a soldering iron

- 3-1. In the case of sizes smaller than 0603, (GC3/GCD/GCE/GCJ/GCM Series, 03/15/18 sizes), the top of the solder fillet should be lower than $\frac{2}{3}$ of the thickness of the component or 0.5mm, whichever is smaller. In the case of 0805 and larger sizes, (GC3/GCD/GCE/GCJ/GCM Series, 21/31/32/43/55 sizes), the top of the solder fillet should be lower than $\frac{2}{3}$ of the thickness of the component. If the solder amount is excessive, the risk of cracking is higher during board bending or under any other stressful condition.

Table 3

Part Number	Temperature of Soldering Iron Tip	Preheating Temperature	Temperature Differential (ΔT)	Atmosphere
GC3/GCD/GCE/ GCJ/GCM Series 03/15/18/21/31 sizes	350°C max.	150°C min.	$\Delta T \leq 190^\circ\text{C}$	Air
GCJ/GCM Series 32/43/55 sizes	280°C max.	150°C min.	$\Delta T \leq 130^\circ\text{C}$	Air

*Applicable for both Pb-Sn and Lead Free Solder.
 Pb-Sn Solder: Sn-37Pb
 Lead Free Solder: Sn-3.0Ag-0.5Cu

Table 4

Distance	5mm or more
Hot Air Application Angle	45° *Figure 1
Hot Air Temperature Nozzle Outlet	400°C max.
Application Time	Less than 10 seconds (1206 (3216 in mm) size or smaller)
	Less than 30 seconds (1210 (3225 in mm) size or larger)

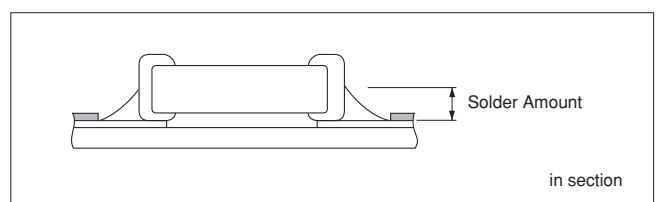
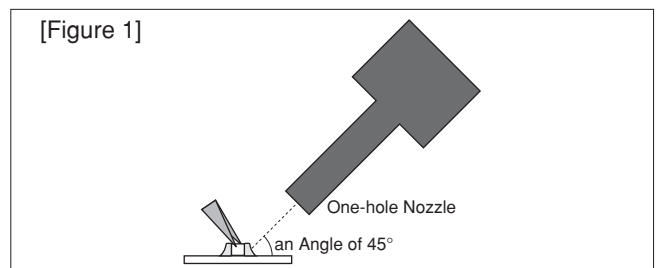

⚠Caution

☐ Continued from the preceding page.

- 3-2. A soldering iron with a tip of $\varnothing 3\text{mm}$ or smaller should be used. It is also necessary to keep the soldering iron from touching the components during the re-work.
- 3-3. Solder wire with $\varnothing 0.5\text{mm}$ or smaller is required for soldering.

<Applicable to KC3/KCM Series>

- 4. For the shape of the soldering iron tip, refer to the figure on the right.

Regarding the type of solder, use a wire diameter of $\varnothing 0.5\text{mm}$ or less (rosin core wire solder).

4-1. How to Apply the Soldering Iron

Apply the tip of the soldering iron against the lower end of the metal terminal.

- 1) In order to prevent cracking caused by sudden heating of the ceramic device, do not touch the ceramic base directly.
- 2) In order to prevent deviations and dislocating of the chip, do not touch the junction of the chip and the metal terminal, and the metal portion on the outside directly.

4-2. Appropriate Amount of Solder

The amount of solder for corrections by soldering iron, should be lower than the height of the lower side of the chip.

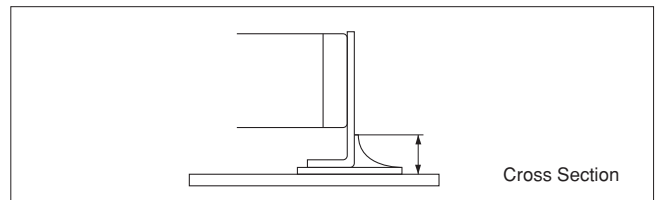
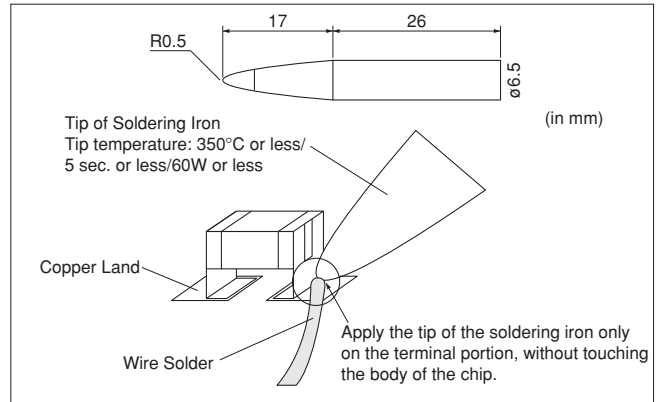

5. Washing

Excessive ultrasonic oscillation during cleaning can cause the PCBs to resonate, resulting in cracked chips or broken solder joints. Take note not to vibrate PCBs.

6. Electrical Test on Printed Circuit Board

- 1. Confirm position of the backup pin or specific jig, when inspecting the electrical performance of a capacitor after mounting on the printed circuit board.

- 1-1. Avoid bending the printed circuit board by the pressure of a test-probe, etc.

The thrusting force of the test probe can flex the PCB, resulting in cracked chips or open solder joints.

Provide backup pins on the back side of the PCB to prevent warping or flexing. Install backup pins as close to the test-probe as possible.

- 1-2. Avoid vibration of the board by shock when a test-probe contacts a printed circuit board.

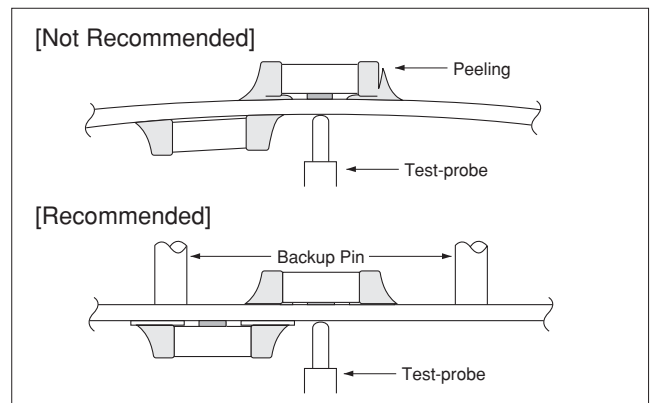

7. Printed Circuit Board Cropping

- 1. After mounting a capacitor on a printed circuit board, do not apply any stress to the capacitor that causes bending or twisting the board.

- 1-1. In cropping the board, the stress as shown at right may cause the capacitor to crack.

Avoid this type of stress to a capacitor.

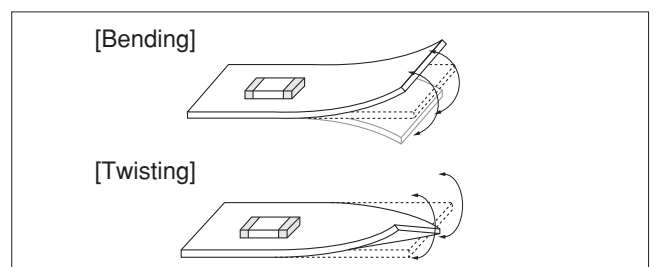

Continued on the following page. ↗

GCM Series

GCD Series

GCE Series

GCG Series

GCH Series

GCH Series

KCM Series

KC3 Series

⚠Caution

☐ Continued from the preceding page.

2. Check the cropping method for the printed circuit board in advance.

2-1. Printed circuit board cropping shall be carried out by using a jig or an apparatus (Disk separator, router type separator, etc.) to prevent the mechanical stress that can occur to the board.

Board Separation Method	Hand Separation Nipper Separation	(1) Board Separation Jig	Board Separation Apparatus	
			(2) Disk Separator	(3) Router Type Separator
Level of stress on board	High	Medium	Medium	Low
Recommended	×	△*	△*	○
Notes	Hand and nipper separation apply a high level of stress. Use another method.	<ul style="list-style-type: none"> Board handling Board bending direction Layout of capacitors 	<ul style="list-style-type: none"> Board handling Layout of slits Design of V groove Arrangement of blades Controlling blade life 	Board handling

* When a board separation jig or disk separator is used, if the following precautions are not observed, a large board deflection stress will occur and the capacitors may crack. Use router type separator if at all possible.

(1) Example of a suitable jig

[In the case of Single-side Mounting]

An outline of the board separation jig is shown as follows. Recommended example: Stress on the component mounting position can be minimized by holding the portion close to the jig, and bend in the direction towards the side where the capacitors are mounted. Not recommended example: The risk of cracks occurring in the capacitors increases due to large stress being applied to the component mounting position, if the portion away from the jig is held and bent in the direction opposite the side where the capacitors are mounted.

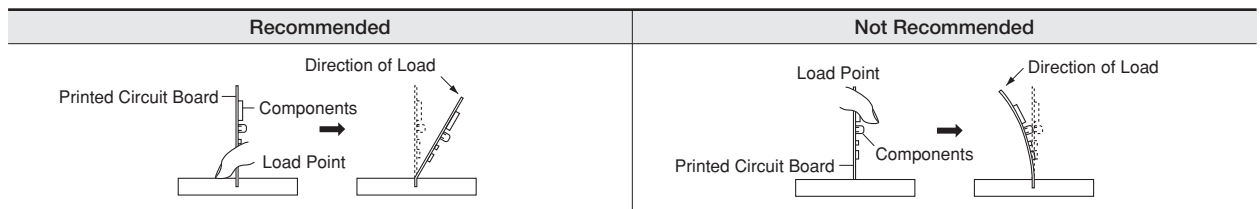
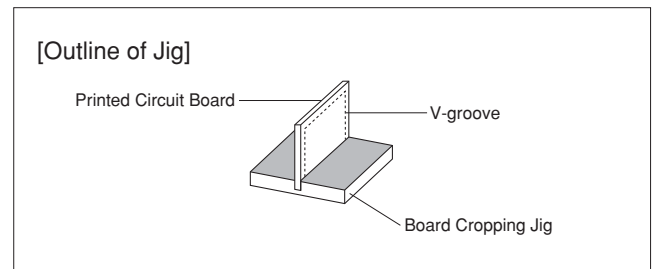

[In the case of Double-sided Mounting]

Since components are mounted on both sides of the board, the risk of cracks occurring can not be avoided with the above method.

Therefore, implement the following measures to prevent stress from being applied to the components. (Measures)

- (1) Consider introducing a router type separator.
If it is difficult to introduce a router type separator, implement the following measures. (Refer to item 1. Mounting Position)
- (2) Mount the components parallel to the board separation surface.
- (3) When mounting components near the board separation point, add slits in the separation position near the component.
- (4) Keep the mounting position of the components away from the board separation point.

⚠Caution

☐ Continued from the preceding page.

(2) Example of a Disk Separator

An outline of a disk separator is shown as follows. As shown in the Principle of Operation, the top blade and bottom blade are aligned with the V-grooves on the printed circuit board to separate the board.

In the following case, board deflection stress will be applied and cause cracks in the capacitors.

- (1) When the adjustment of the top and bottom blades are misaligned, such as deviating in the top-bottom, left-right or front-rear directions
- (2) The angle of the V groove is too low, depth of the V groove is too shallow, or the V groove is misaligned top-bottom

IF V groove is too deep, it is possible to brake when you handle and carry it. Carefully design depth of the V groove with consideration about strength of material of the printed circuit board.

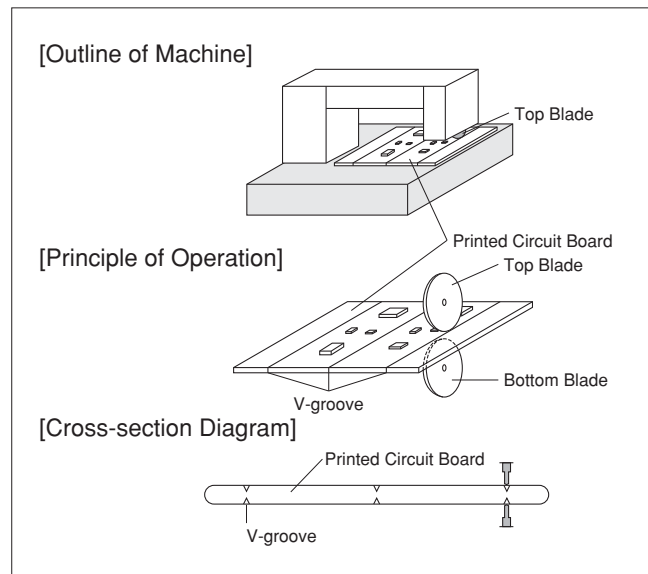

Recommended	Not Recommended		
	Top-bottom Misalignment	Left-right Misalignment	Front-rear Misalignment
<p>Top Blade</p> <p>Bottom Blade</p>	<p>Top Blade</p> <p>Bottom Blade</p>	<p>Top Blade</p> <p>Bottom Blade</p>	<p>Top Blade</p> <p>Bottom Blade</p>

Example of Recommended V-groove Design	Not Recommended			
	Left-right Misalignment	Low-Angle	Depth too Shallow	Depth too Deep

(3) Example of Router Type Separator

The router type separator performs cutting by a router rotating at a high speed. Since the board does not bend in the cutting process, stress on the board can be suppressed during board separation.

When attaching or removing boards to/from the router type separator, carefully handle the boards to prevent bending.

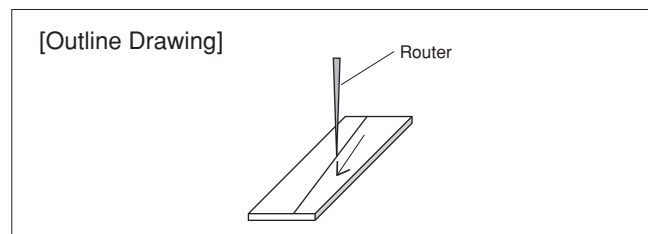

Continued on the following page. ☐

GCM Series

GCD Series

GCE Series

GCG Series

GCI Series

GCS Series

KCM Series

KC3 Series

⚠Caution

☐ Continued from the preceding page.

8. Assembly

1. Handling

If a board mounted with capacitors is held with one hand, the board may bend. Firmly hold the edges of the board with both hands when handling.

If a board mounted with capacitors is dropped, cracks may occur in the capacitors.

Do not use dropped boards, as there is a possibility that the quality of the capacitors may be impaired.

2. Attachment of Other Components

2-1. Mounting of Other Components

Pay attention to the following items, when mounting other components on the back side of the board after capacitors have been mounted on the opposite side. When the bottom dead point of the suction nozzle is set too low, board deflection stress may be applied to the capacitors on the back side (bottom side), and cracks may occur in the capacitors.

- After the board is straightened, set the bottom dead point of the nozzle on the upper surface of the board.
- Periodically check and adjust the bottom dead point.

2-2. Inserting Components with Leads into Boards

When inserting components (transformers, IC, etc.) into boards, bending the board may cause cracks in the capacitors or cracks in the solder.

Pay attention to the following.

- Increase the size of the holes to insert the leads, to reduce the stress on the board during insertion.
- Fix the board with backup pins or a dedicated jig before insertion.
- Support below the board so that the board does not bend. When using multiple backup pins on the board, periodically confirm that there is no difference in the height of each backup pin.

2-3. Attaching/Removing Sockets

When the board itself is a connector, the board may bend when a socket is attached or removed. Plan the work so that the board does not bend when a socket is attached or removed.

2-4. Tightening Screws

The board may be bent, when tightening screws, etc. during the attachment of the board to a shield or chassis.

Pay attention to the following items before performing the work.

- Plan the work to prevent the board from bending.
- Use a torque screwdriver, to prevent over-tightening of the screws.
- The board may bend after mounting by reflow soldering, etc. Please note, as stress may be applied to the chips by forcibly flattening the board when tightening the screws.

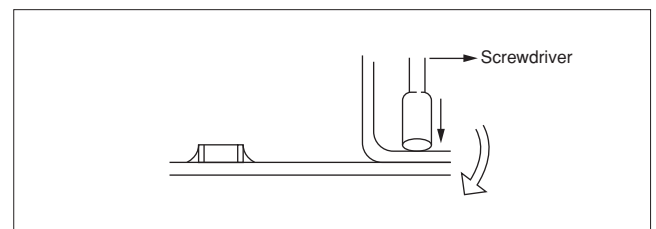
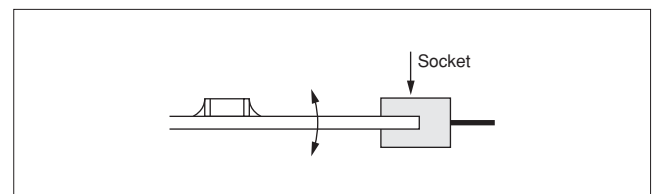
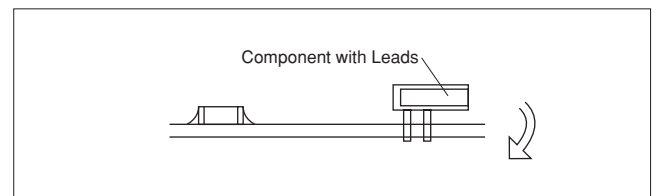
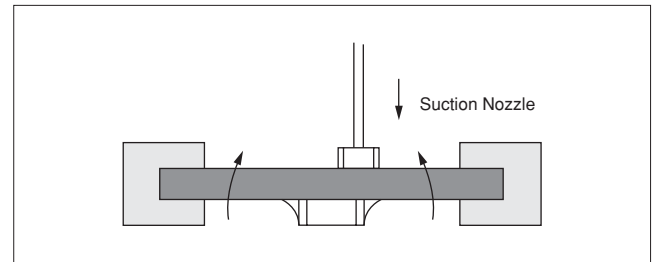

GCM Series

GCD Series

GCE Series

GCG Series

GCJ Series

GC3 Series

KCM Series

KC3 Series

⚠Caution

Continued on the following page. ☐

⚠Caution

☐ Continued from the preceding page.

<Applicable to GCG Series>

9. Selection of Conductive Adhesive, Mounting Process, and Bonding Strength

The acquired bonding strength may change greatly depending on the conductive adhesive to be used.

Be sure to confirm if the desired performance can be acquired in the assumed mounting process with the conductive adhesive to be used.

10. Moisture Proof Process

In order to prevent the occurrence of migration, perform a moisture proof process, such as applying a resin coating or enclosing with a dry inert gas.

11. Application

This product is for conductive adhesive mounting. When performing solder mounting, contact Murata in advance.

■ Other

1. Under Operation of Equipment

- 1-1. Do not touch a capacitor directly with bare hands during operation in order to avoid the danger of an electric shock.
- 1-2. Do not allow the terminals of a capacitor to come in contact with any conductive objects (short-circuit). Do not expose a capacitor to a conductive liquid, including any acid or alkali solutions.
- 1-3. Confirm the environment in which the equipment will operate is under the specified conditions. Do not use the equipment under the following environments.
 - (1) Being splattered with water or oil.
 - (2) Being exposed to direct sunlight.
 - (3) Being exposed to ozone, ultraviolet rays, or radiation.
 - (4) Being exposed to toxic gas (e.g., hydrogen sulfide, sulfur dioxide, chlorine, ammonia gas, etc.)
 - (5) Any vibrations or mechanical shocks exceeding the specified limits.
 - (6) Moisture condensing environments.
- 1-4. Use damp proof countermeasures if using under any conditions that can cause condensation.

2. Other

- 2-1. In an Emergency
 - (1) If the equipment should generate smoke, fire, or smell, immediately turn off or unplug the equipment. If the equipment is not turned off or unplugged, the hazards may be worsened by supplying continuous power.
 - (2) In this type of situation, do not allow face and hands to come in contact with the capacitor or burns may be caused by the capacitor's high temperature.

2-2. Disposal of Waste

When capacitors are disposed of, they must be burned or buried by an industrial waste vendor with the appropriate licenses.

2-3. Circuit Design

- (1) Addition of Fail Safe Function
Capacitors that are cracked by dropping or bending of the board may cause deterioration of the insulation resistance, and result in a short. If the circuit being used may cause an electrical shock, smoke or fire when a capacitor is shorted, be sure to install fail-safe functions, such as a fuse, to prevent secondary accidents.
- (2) Capacitors used to prevent electromagnetic interference in the primary AC side circuit, or as a connection/insulation, must be a safety standard certified product, or satisfy the contents stipulated in the Electrical Appliance and Material Safety Law. Install a fuse for each line in case of a short.
- (3) The GC3, GCD, GCE, GCG, GCJ, GCM, KC3, and KCM series are not safety standard certified products.

2-4. Remarks

Failure to follow the cautions may result, worst case, in a short circuit and smoking when the product is used.

The above notices are for standard applications and conditions. Contact us when the products are used in special mounting conditions.

Select optimum conditions for operation as they determine the reliability of the product after assembly. The data herein are given in typical values, not guaranteed ratings.

■ Rating

1. Operating Temperature

1. The operating temperature limit depends on the capacitor.

1-1. Do not apply temperatures exceeding the upper operating temperature.

It is necessary to select a capacitor with a suitable rated temperature that will cover the operating temperature range.

It is also necessary to consider the temperature distribution in equipment and the seasonal temperature variable factor.

1-2. Consider the self-heating factor of the capacitor.

The surface temperature of the capacitor shall be the upper operating temperature or less when including the self-heating factors.

2. Atmosphere Surroundings (gaseous and liquid)

1. Restriction on the operating environment of capacitors.

1-1. Capacitors, when used in the above, unsuitable,

operating environments may deteriorate due to the corrosion of the terminations and the penetration of moisture into the capacitor.

1-2. The same phenomenon as the above may occur when the electrodes or terminals of the capacitor are subject to moisture condensation.

1-3. The deterioration of characteristics and insulation resistance due to the oxidization or corrosion of terminal electrodes may result in breakdown when the capacitor is exposed to corrosive or volatile gases or solvents for long periods of time.

3. Piezo-electric Phenomenon

1. When using high dielectric constant type capacitors in AC or pulse circuits, the capacitor itself vibrates at specific frequencies and noise may be generated. Moreover, when the mechanical vibration or shock is added to the capacitor, noise may occur.

■ Soldering and Mounting

1. PCB Design

1. Notice for Pattern Forms



1-1. Unlike leaded components, chip components are susceptible to flexing stresses since they are mounted directly on the substrate.

They are also more sensitive to mechanical and thermal stresses than leaded components.

Excess solder fillet height can multiply these stresses and cause chip cracking. When designing substrates, take land patterns and dimensions into consideration to eliminate the possibility of excess solder fillet height.

1-2. There is a possibility of chip cracking caused by PCB expansion/contraction with heat, because stress on a chip is different depending on PCB material and structure. When the thermal expansion coefficient greatly differs between the board used for mounting and the chip, it will cause cracking of the chip due to the thermal expansion and contraction. When small size capacitors of 0402 size or less are mounted on a single-layered glass epoxy board, it will also cause cracking of the chip for the same reason.

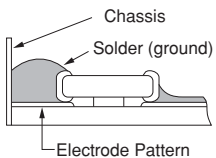
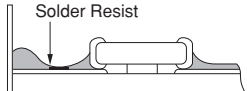
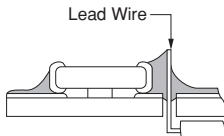
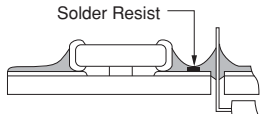
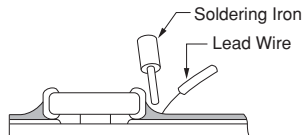
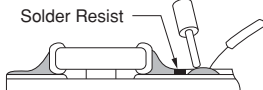
Pattern Forms

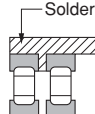
	Prohibited	Correct
Placing Close to Chassis		
Placing of Chip Components and Leaded Components		
Placing of Leaded Components after Chip Component		
Lateral Mounting		

Continued on the following page. ↗

GCM Series

GCD Series

GCE Series

GCG Series

G CJ Series

GC3 Series

KCM Series

KC3 Series

Notice

Notice

☐ Continued from the preceding page.

2. Land Dimensions

2-1. Chip capacitors can be cracked due to the stress of PCB bending, etc. if the land area is larger than needed and has an excess amount of solder. Please refer to the land dimensions in table 1 for flow soldering, table 2 for reflow soldering. Please confirm the suitable land dimension by evaluating of the actual SET / PCB.

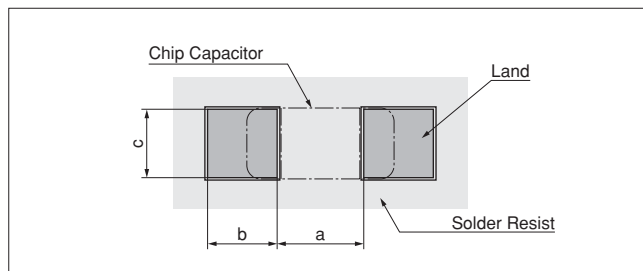

Table 1 Flow Soldering Method

Part Number	Dimensions	Chip (L×W)	a	b	c
GC3/GCD/GCM/GCJ Series 18 size (Rated Voltage: above 250VDC (for GCJ alone))		1.6×0.8	0.6 to 1.0	0.8 to 0.9	0.6 to 0.8
GC3/GCD/GCM/GCJ Series 21 size (Rated Voltage: above 250VDC (for GCJ alone))		2.0×1.25	1.0 to 1.2	0.9 to 1.0	0.8 to 1.1
GC3/GCD/GCM/GCJ Series 31 size (Rated Voltage: above 250VDC (for GCJ alone))		3.2×1.6	2.2 to 2.6	1.0 to 1.1	1.0 to 1.4

Flow soldering can only be used for products with a chip size from 1.6x0.8mm to 3.2x1.6mm.

(in mm)

Table 2 Reflow Soldering Method

Part Number	Dimensions	Chip (L×W)	a	b	c
GC3/GCD/GCE/GCJ/GCM Series 03 size		0.6×0.3	0.2 to 0.3	0.2 to 0.35	0.2 to 0.4
GC3/GCD/GCE/GCJ/GCM Series 15 size		1.0×0.5	0.3 to 0.5	0.35 to 0.45	0.4 to 0.6
GQM/GR3/GRJ/GRM Series 18 size		1.6×0.8	0.6 to 0.8	0.6 to 0.7	0.6 to 0.8
GC3/GCD/GCE/GCJ/GCM Series 21 size		2.0×1.25	1.0 to 1.2	0.6 to 0.7	0.8 to 1.1
GC3/GCD/GCE/GCJ/GCM Series 31 size		3.2×1.6	2.2 to 2.4	0.8 to 0.9	1.0 to 1.4
GC3/GCD/GCE/GCJ/GCM Series 32 size		3.2×2.5	2.0 to 2.4	1.0 to 1.2	1.8 to 2.3
GC3/GCD/GCE/GCJ/GCM Series 43 size		4.5×3.2	3.0 to 3.5	1.2 to 1.4	2.3 to 3.0
GC3/GCD/GCE/GCJ/GCM Series 55 size		5.7×5.0	4.0 to 4.6	1.4 to 1.6	3.5 to 4.8

(in mm)

<Applicable to Part Number **KC3/KCM**>

Part Number	Dimensions	Chip (L×W)	a	b	c
KC3/KCM Series 55 size		5.7×5.0	2.6	2.7	5.6

(in mm)

<Applicable to beyond Rated Voltage of 250VDC>

2-2. Dimensions of Slit (Example)

Preparing the slit helps flux cleaning and resin coating on the back of the capacitor. However, the length of the slit design should be as short as possible to prevent mechanical damage in the capacitor.

A longer slit design might receive more severe mechanical stress from the PCB.

Recommended slit design is shown in the Table.

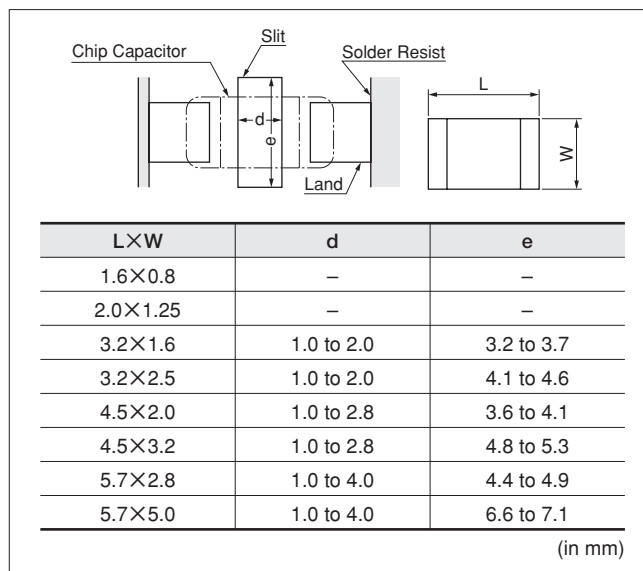

Continued on the following page. ↗

Continued from the preceding page.

3. Board Design

When designing the board, keep in mind that the amount of strain which occurs will increase depending on the size and material of the board.

[Relationship with amount of strain to the board thickness, length, width, etc.]

$$\epsilon = \frac{3PL}{2Ewh^2}$$

Relationship between load and strain

- ε: Strain on center of board (μst)
- L: Distance between supporting points (mm)
- w: Board width (mm)
- h: Board thickness (mm)
- E: Elastic modulus of board (N/m²=Pa)
- Y: Deflection (mm)
- P: Load (N)

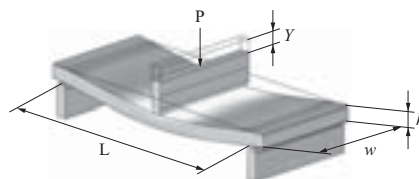

When the load is constant, the following relationship can be established.

- As the distance between the supporting points (L) increases, the amount of strain also increases.
→Reduce the distance between the supporting points.
 - As the elastic modulus (E) decreases, the amount of strain increases.
→Increase the elastic modulus.
 - As the board width (w) decreases, the amount of strain increases.
→Increase the width of the board.
 - As the board thickness (h) decreases, the amount of strain increases.
→Increase the thickness of the board.
- Since the board thickness is squared, the effect on the amount of strain becomes even greater.

2. Adhesive Application

1. Thin or insufficient adhesive can cause the chips to loosen or become disconnected during flow soldering. The amount of adhesive must be more than dimension c, shown in the drawing at right, to obtain the correct bonding strength.

The chip's electrode thickness and land thickness must also be taken into consideration.

2. Low viscosity adhesive can cause chips to slip after mounting. The adhesive must have a viscosity of 5000Pa · s (500ps) min. (at 25°C).

3. Adhesive Coverage

Size (L×W) (in mm)	Adhesive Coverage*
1.6×0.8	0.05mg min.
2.0×1.25	0.1mg min.
3.2×1.6	0.15mg min.

*Nominal Value

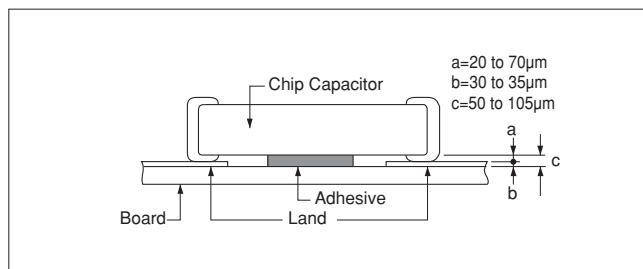

3. Adhesive Curing

1. Insufficient curing of the adhesive can cause chips to disconnect during flow soldering and causes deterioration in the insulation resistance between the outer electrodes due to moisture absorption.

Control curing temperature and time in order to prevent insufficient hardening.

Continued on the following page. ↗

Notice

☐ Continued from the preceding page.

4. Flux for Reflow and Flow Soldering

1. An excessive amount of flux generates a large quantity of flux gas, which can cause a deterioration of solder ability, so apply flux thinly and evenly throughout. (A foaming system is generally used for flow soldering.)
2. Flux containing too high a percentage of halide may cause corrosion of the outer electrodes unless there is sufficient cleaning. Use flux with a halide content of 0.1% max.

3. Do not use strong acidic flux.
4. Do not use water-soluble flux.*
 (*Water-soluble flux can be defined as non-rosin type flux including wash-type flux and non-wash-type flux.)

5. Flow Soldering

- Set temperature and time to ensure that leaching of the outer electrode does not exceed 25% of the chip end area as a single chip (full length of the edge A-B-C-D shown at right) and 25% of the length A-B shown as mounted on substrate.

[As a Single Chip]

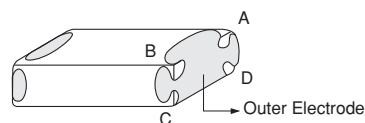

[As Mounted on Substrate]

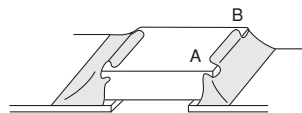

6. Washing

1. Please evaluate the capacitor using actual cleaning equipment and conditions to confirm the quality, and select the solvent for cleaning.
2. Unsuitable cleaning solvent may leave residual flux or other foreign substances, causing deterioration of electrical characteristics and the reliability of the capacitors.

3. Select the proper cleaning conditions.
 3-1. Improper cleaning conditions (excessive or insufficient) may result in deterioration of the performance of the capacitors.

7. Coating

1. A crack may be caused in the capacitor due to the stress of the thermal contraction of the resin during curing process.
 The stress is affected by the amount of resin and curing contraction.
 Select a resin with low curing contraction.
 The difference in the thermal expansion coefficient between a coating resin or a molding resin and the capacitor may cause the destruction and deterioration of the capacitor such as a crack or peeling, and lead to the deterioration of insulation resistance or dielectric breakdown.
 Select a resin for which the thermal expansion coefficient is as close to that of the capacitor as possible.
 A silicone resin can be used as an under-coating to buffer against the stress.

2. Select a resin that is less hygroscopic.
 Using hygroscopic resins under high humidity conditions may cause the deterioration of the insulation resistance of a capacitor.
 An epoxy resin can be used as a less hygroscopic resin.

Continued on the following page. ☐

☐ Continued from the preceding page.

■ Other

1. Transportation

1. The performance of a capacitor may be affected by the conditions during transportation.
 - 1-1. The capacitors shall be protected against excessive temperature, humidity, and mechanical force during transportation.
 - (1) Climatic condition
 - low air temperature: -40°C
 - change of temperature air/air: -25°C/+25°C
 - low air pressure: 30 kPa
 - change of air pressure: 6 kPa/min.
 - (2) Mechanical condition

Transportation shall be done in such a way that the boxes are not deformed and forces are not directly passed on to the inner packaging.
 - 1-2. Do not apply excessive vibration, shock, or pressure to the capacitor.
 - (1) When excessive mechanical shock or pressure is applied to a capacitor, chipping or cracking may occur in the ceramic body of the capacitor.
 - (2) When the sharp edge of an air driver, a soldering iron, tweezers, a chassis, etc. impacts strongly on the surface of the capacitor, the capacitor may crack and short-circuit.
 - 1-3. Do not use a capacitor to which excessive shock was applied by dropping, etc.

A capacitor dropped accidentally during processing may be damaged.

2. Characteristics Evaluation in the Actual System

1. Evaluate the capacitor in the actual system, to confirm that there is no problem with the performance and specification values in a finished product before using.
2. Since a voltage dependency and temperature dependency exists in the capacitance of high dielectric type ceramic capacitors, the capacitance may change depending on the operating conditions in the actual system. Therefore, be sure to evaluate the various characteristics, such as the leakage current and noise absorptivity, which will affect the capacitance value of the capacitor.
3. In addition, voltages exceeding the predetermined surge may be applied to the capacitor by the inductance in the actual system. Evaluate the surge resistance in the actual system as required.

GCM Series

GCD Series

GCE Series

GCG Series

GCJ Series

GC3 Series

KCM Series

KC3 Series

Notice

Design assistant tool: SimSurfing SimSurfing

MLCC is now available !

Design assistant tool "SimSurfing" has been updated and you can now find and view any kind of characteristics of MLCCs.

Available function for MLCCs:

- ① Products search
- ② View frequency characteristics (S parameters, Z, R, X, Q, DF, L, C)
DC bias can be applied to available part number.
- ③ DC voltage bias characteristics (absolute capacitance/change rate)
- ④ Temperature characteristics (absolute capacitance/change rate)
- ⑤ AC voltage bias characteristics (absolute capacitance/change rate)
- ⑥ Download SPICE netlist/ S parameter

1 Select the Products

- (1) By part number
- (2) By specification

2 View characteristics

By clicking buttons in this area with part number selected, you can view any electrical characteristics chart.

3 Data download

You can download SPICE netlist and S parameter files (S2P)



Added the capacitor finder tool for middle and high voltage capacitor which are capable for specified voltage waveform.

These images are captured at May/2013. Be sure that this software will be updated frequently.

<http://ds.murata.com/software/simsurfing/en-us/mlcc/>

EMICON-FUN!

Please check Murata's newsletter!
 You can learn about electric parts with fun.
http://www.murata.com/products/emicon_fun/

EMICON-FUN! disseminated widely from basics (principles, characteristics, mounting, etc.) of capacitors, inductors and EMI suppression filters to information can practically be used.

Updated information is also distributed via the mail magazine.

Click here to register as reader → http://go.murata.co.jp/Email_Newsletter_EN.html

You can register from the Products page on Murata Manufacturing website.
<http://www.murata.com/products/>



← This banner is the entrance of register form

The screenshot shows the Murata website interface. At the top, there's a navigation bar with 'muRata Global', 'News', 'Products', 'About MURATA', and 'Investor Relations'. Below this is a search bar and a 'Select Topics' dropdown. The main content area features the 'EMICON-FUN!' logo and a description: 'Wide range of information about capacitors, noise suppression filters, and inductors.' There are three main content boxes: 'Capacitor Room', 'Noise suppression filter Room', and 'Inductor Room'. Each box contains several technical articles with titles and brief descriptions. A 'For the EARTH' section is also visible at the bottom. Overlaid on the right side of the screenshot is a preview of the 'muRata Newsletter "EMICON-FUN!"' containing a table of contents and a detailed article snippet about 'Evolving Capacitors - Monolithic Ceramic Capacitors - Part 1 Trend (part 2/2)'.

Capacitor Website Introduction

The website and search engine of ceramic capacitors has been drastically renewed.



Convenient Search

The type of searches has been increased to respond to various ways of searching.
 The products you are searching for can easily be found from about 40,000 part numbers!
 The frequency of revisions and discontinuance has been increased to provide the latest information at all times!

Substantial Technical Information

- Reference drawings (Specifications and Test Methods) can be downloaded in PDF format.
- Graphs of the electrical characteristic data (Capacitance - Temperature characteristics / DC bias characteristics / AC voltage characteristics / Frequency characteristics) can be displayed.
- Reliability test data can be downloaded.

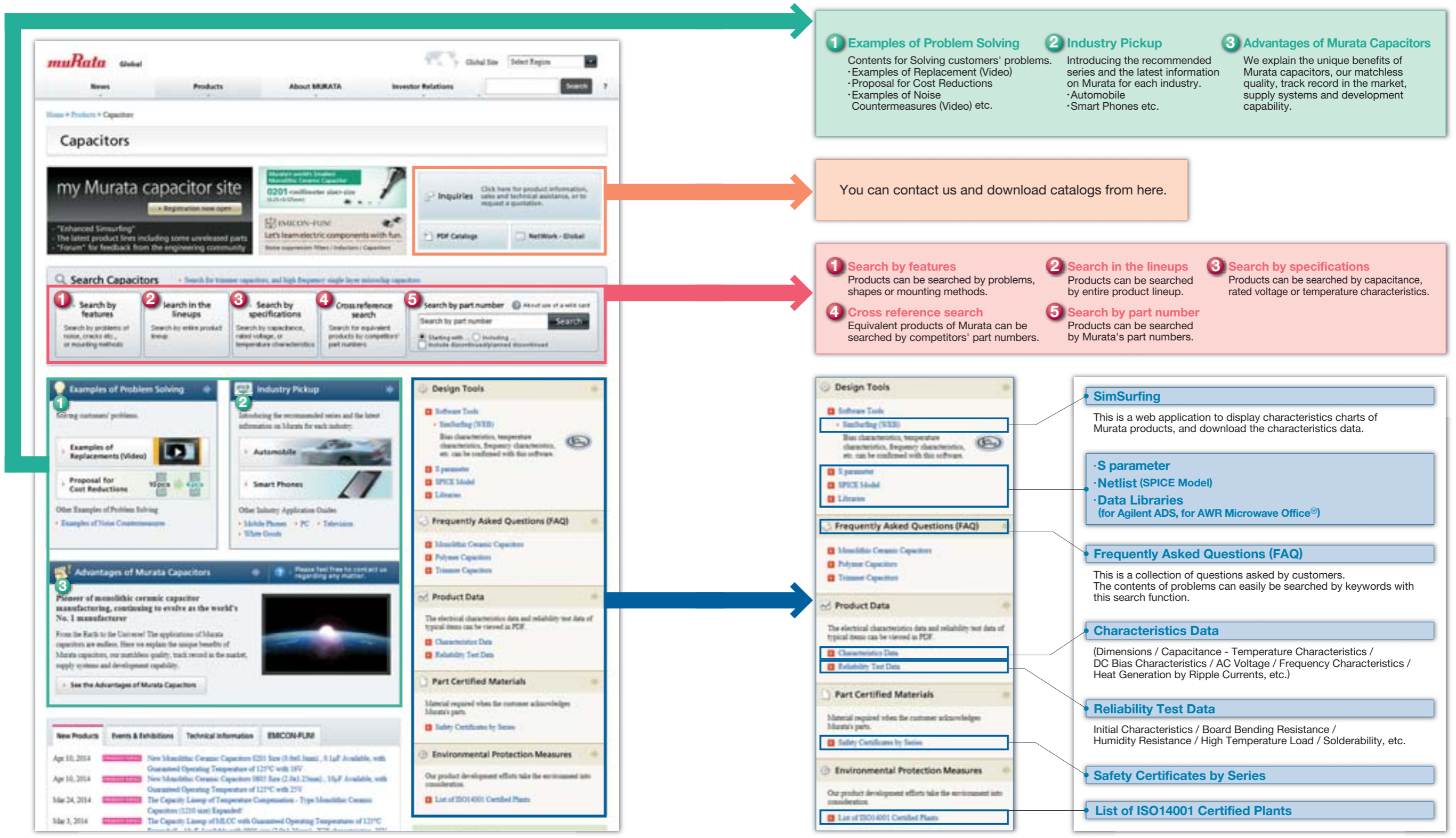

Global Locations

For details please visit www.murata.com



⚠ Note

1 Export Control

For customers outside Japan:

No Murata products should be used or sold, through any channels, for use in the design, development, production, utilization, maintenance or operation of, or otherwise contribution to (1) any weapons (Weapons of Mass Destruction [nuclear, chemical or biological weapons or missiles] or conventional weapons) or (2) goods or systems specially designed or intended for military end-use or utilization by military end-users.

For customers in Japan:

For products which are controlled items subject to the "Foreign Exchange and Foreign Trade Law" of Japan, the export license specified by the law is required for export.

2 Please contact our sales representatives or product engineers before using the products in this catalog for the applications listed below, which require especially high reliability for the prevention of defects which might directly damage a third party's life, body or property, or when one of our products is intended for use in applications other than those specified in this catalog.

- ① Aircraft equipment
- ② Aerospace equipment
- ③ Undersea equipment
- ④ Power plant equipment
- ⑤ Medical equipment
- ⑥ Transportation equipment (vehicles, trains, ships, etc.)
- ⑦ Traffic signal equipment
- ⑧ Disaster prevention / crime prevention equipment
- ⑨ Data-processing equipment
- ⑩ Application of similar complexity and/or reliability requirements to the applications listed above

3 Product specifications in this catalog are as of March 2014. They are subject to change or our products in it may be discontinued without advance notice. Please check with our sales representatives or product engineers before ordering. If there are any questions, please contact our sales representatives or product engineers.

4 Please read rating and ⚠CAUTION (for storage, operating, rating, soldering, mounting and handling) in this catalog to prevent smoking and/or burning, etc.

5 This catalog has only typical specifications. Therefore, please approve our product specifications or transact the approval sheet for product specifications before ordering.

6 Please note that unless otherwise specified, we shall assume no responsibility whatsoever for any conflict or dispute that may occur in connection with the effect of our and/or a third party's intellectual property rights and other related rights in consideration of your use of our products and/or information described or contained in our catalogs. In this connection, no representation shall be made to the effect that any third parties are authorized to use the rights mentioned above under licenses without our consent.

7 No ozone depleting substances (ODS) under the Montreal Protocol are used in our manufacturing process.

Murata Manufacturing Co., Ltd.

www.murata.com

muRata
INNOVATOR IN ELECTRONICS

Mouser Electronics

Authorized Distributor

Click to View Pricing, Inventory, Delivery & Lifecycle Information:

Murata:

[GCM2195C2A120JD27J](#) [GCM219R72A271KD46F](#) [GCM2165C1H471JA02D](#) [GCM1885C1H470JA16D](#)
[GCM319R72A681KD79D](#) [GCM1885C1H101JA02D](#) [GCM21BR71C334KC01L](#) [GCM21BR71H104KA02K](#)
[GCM188R71C104KA13D](#) [GCM1885C1H3R0CD43D](#) [GCM1885C1H3R0CD27D](#) [GCM1885C1H4R0CD27D](#)
[GCM2165C1H180JD01D](#) [GCM2165C1H180JD14D](#) [GCM21BR71A105KC16L](#) [GCM21BR71A105KC02K](#)
[GCM1885C1H120JD30E](#) [GCM188R71E273JA02D](#) [GCM188R71E223KA02D](#) [GCM2165C1H820JD43D](#)
[GCM219R71H123KA01D](#) [GCM188R71C473KA02J](#) [GCM21BR71H473KD58E](#) [GCM2165C1H220JD43D](#)
[GCM21BR72A103KA02L](#) [GCM21BR72A103KA01K](#) [GCM188R71H331KD01D](#) [GCM1885C1H180JA02D](#)
[GCM1885C1H9R1CD43D](#) [GCM32ER71E225KA02L](#) [GCM31MR71A225KC25L](#) [GCM32ER71E225MA02L](#)
[GCM216R71H472KA19D](#) [GCM216R71H472KA26D](#) [GCM216R71H472KA01K](#) [GCM1885C1H270JA01D](#)
[GCM31MR71H154KA37L](#) [GCM1885C2A102JA16D](#) [GCM188R71C104KA37D](#) [GCM188R72A103KA37D](#)
[GCM1885C1H1R0CZ13D](#) [GCM3195C1H223JA16D](#) [GCM21BR71C225KA64L](#) [GCM1555C1H100JZ13D](#)
[GCM32ER71H475KA55L](#) [GCM155R71C104KA55D](#) [GCM31CR71H225KA55L](#) [GCM2195C2A152JA16D](#)
[GCM1885C2A101JA16D](#) [GCM188R71C474KA55D](#) [GCM188R71H104KA57D](#) [GCM1885C2A100JA16D](#)
[GCM1555C1H1R0CZ13D](#) [GCM31CR71A106KA64L](#) [GCM3195C2A562JA16D](#) [GCM1885C1H102JA16D](#)
[GCM155R72A472KA37D](#) [GCM155R71E473KA55D](#) [GCM155R71H102KA37D](#) [GCM155R72A102KA37D](#)
[GCM188R71H103KA37D](#) [GCM155R71H223KA55D](#) [GCM31CR71E475KA55L](#) [GCM1885C1H100JA16D](#)
[GCM2195C1H103JA16D](#) [GCM21BR71E225KA73L](#) [GCM32ER71A226KE12L](#) [GCM21BR71E105KA56L](#)
[GCM1885C2A1R0CZ13D](#) [GCM31CR71C106KA64L](#) [GCM188R72A102KA37D](#) [GCM188R71H102KA37D](#)
[GCM188R71E474KA64D](#) [GCM188R72A223KA37D](#) [GCM1555C1H471JA16D](#) [GCM155R71H103KA55D](#)
[GCM1555C1H101JZ13D](#) [GCM21BR72A104KA37L](#) [GCM32ER71E106KA57L](#) [GCM155R71H681KA37D](#)
[GCM32ER71E225KA17L](#) [GCM31MR71C105KC23L](#) [GCM31MR71C105KC21L](#) [GCM31MR71C105KC02L](#)
[GCM31MR71C105KC18K](#) [GCM31MR71C105KC16L](#) [GCM32ER71H105MA17L](#) [GCM216R71H222KA19D](#)
[GCM32ER71H105MA02L](#) [GCM21BL81H104KA37L](#) [GCM31MR71H334KA37L](#) [GCM2165C1H120JZ13D](#)
[GCM2165C1H121JA16D](#) [GCM2165C1H122JA16D](#) [GCM2165C1H150JZ13D](#) [GCM31MR71H474KA37L](#)
[GCM2165C1H100JZ13D](#) [GCM21BR91H104KA37L](#) [GCM2165C1H180JZ13D](#) [GCM216R71H103KA37J](#)