

One-way flow control valves



Festo core product range
Covers 80% of your automation tasks

Worldwide:

Always in stock

Superb:

Festo quality at an attractive price

Easy:

Reduces procurement and storing complexity



Ready for dispatch from the Festo factory in 24 hours
Held in stock in 13 service centres worldwide
More than 2200 products



Ready for dispatch in 5 days maximum from stock
Assembled for you in 4 service centres worldwide
Up to 6 x 10¹² variants per product series

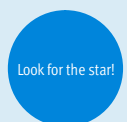

One-way flow control valves

Key features

Function

Flow control or one-way flow control valves regulate the piston speed of pneumatic drives during advance and return strokes. This is done through suitable restriction of the flow rate of compressed air in exhaust air or supply air direction. With the one-way

flow control valve GRLA or GRLZ, the flow control function works in one direction only (exhaust air or supply air); the non-return function works in the opposite direction. With the flow control valve GRLO, the flow control function is active in both directions.

The flow control function creates an adjustable annular gap inside the valve. This gap can be increased or decreased by turning the knurled screw or slotted head screw. The required restriction can be set with the help of this adjustment component.

Note
The documentation for the flow control valves can be found at www.festo.com/catalogue

General information

Standard nominal flow rate q_{nN}

The standard nominal flow rate q_{nN} is the flow rate based on standard conditions at an operating pressure of $p_1 = 6$ bar and an output pressure of $p_2 = 5$ bar, measured at room temperature $t = 20$ °C.

Exhaust air one-way flow control function

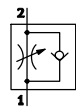

Supply air one-way flow control function

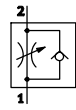

Standard flow rate q_n

The standard flow rate is measured at an operating pressure of $p_1 = 6$ bar and an output pressure with respect to atmospheric pressure ($p_2 = 0$ bar).

Flow control function in both directions



Flow measurement circuit

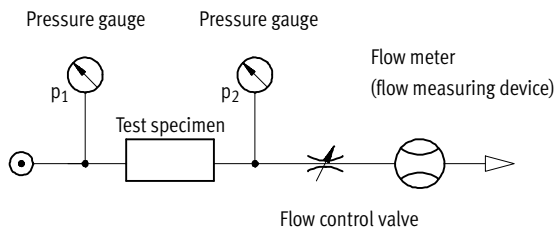

p_1 Operating pressure
 p_2 Output pressure

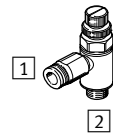

- 1 Supply port (pneumatic connection 1)
- 2 Working line (pneumatic connection 2)

One-way flow control valves

Key features

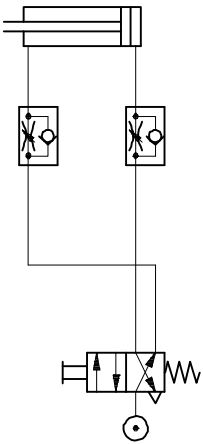
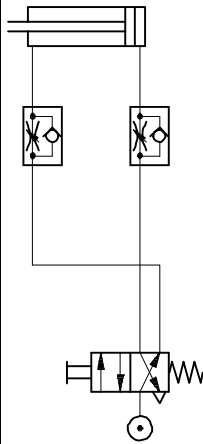
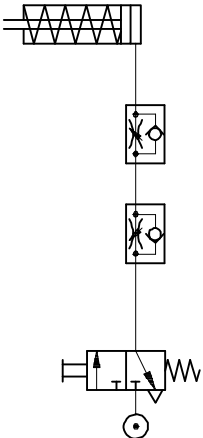
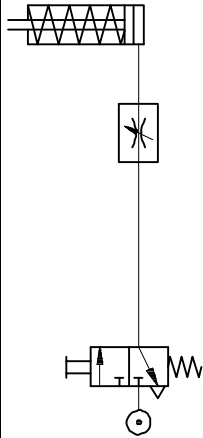
Flow control functions and range of applications			
Application		Description	
Double-acting cylinder with one-way flow control valve			
Exhaust air one-way flow control function		Supply air one-way flow control function	
	Speed adjustment through exhaust air flow control. Uncontrolled supply air and controlled exhaust air move the piston between air cushions (improves motion, even with load changes).		Adjustable speed during advance and return strokes. The flow rate is identical in both directions.
Single-acting cylinder with one-way flow control valve		Single-acting cylinder with flow control valve	
Exhaust air and supply air one-way flow control function		Flow control function in both directions	
	Adjustable speed during advance and return strokes. The flow rate can be adjusted differently for both directions.		Speed adjustment through flow control on both sides is often applied in the case of single-acting or small cylinders. The benefit of this application lies in its simplicity.

Application examples

Mini slide SLT with one-way flow control valve, standard

Flat cylinder DZF with one-way flow control valve, mini



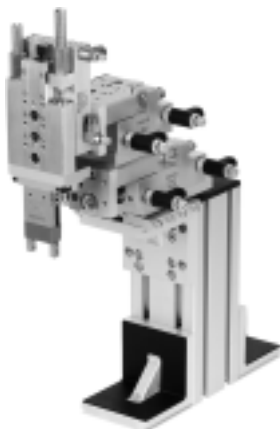







Multimount cylinder DMM with one-way flow control valve, mini



One-way flow control valves

Product range overview

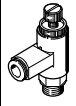
FESTO

Version	Valve function	Version	Type	Connection direction	Pneumatic connection 1	Pneumatic connection 2	q _n N ¹⁾ [l/min]	Adjustment component	→ Page/ Internet				
Standard	Metal												
	Exhaust air one-way flow control function		GRLA	Elbow outlet	QS-3, QS-4, QS-6, QS-8, QS-10, QS-12	M5, G ¹ / ₈ , G ¹ / ₄ , G ³ / ₈ , G ¹ / ₂	100 ... 1,580	Slotted head screw	8				
								Knurled screw					
									M5, G ¹ / ₈ , G ¹ / ₄ , G ³ / ₈ , G ¹ / ₂ , G ³ / ₄	M5, G ¹ / ₈ , G ¹ / ₄ , G ³ / ₈ , G ¹ / ₂ , G ³ / ₄	95 ... 4,320	Slotted head screw	12
									M5, G ¹ / ₈ , G ¹ / ₄	M5, G ¹ / ₈ , G ¹ / ₄	95 ... 610	Knurled screw	
		PK-3, PK-4, PK-6	M5, G ¹ / ₈ , G ¹ / ₄	83 ... 540	Slotted head screw	12							
	Supply air one-way flow control function		GRLZ	Elbow outlet	QS-3, QS-4, QS-6, QS-8	M5, G ¹ / ₈	100 ... 215	Slotted head screw	8				
										M5, G ¹ / ₈ , G ¹ / ₄	M5, G ¹ / ₈ , G ¹ / ₄	95 ... 610	Slotted head screw
										PK-3, PK-4, PK-6	M5, G ¹ / ₈ , G ¹ / ₄	83 ... 540	Slotted head screw
		VFOC-S	Elbow outlet	QS-4, QS-6	Push-in sleeve ²⁾ QS-4, QS-6	100 ... 270	Slotted head screw	20					
Nickel-plated metal													
Exhaust air one-way flow control function		VFOH-LE	Elbow outlet	QS-4, QS-6, QS-8, QS-10	G ¹ / ₈ , G ¹ / ₄	180 ... 530	External hex	22					
Polymer													
Exhaust air one-way flow control function		GRLA	Elbow outlet	QS-6, QS-8	G ¹ / ₈ , G ¹ / ₄ , G ³ / ₈	520 ... 650	Knurled screw	24					
Flat													
Exhaust air one-way flow control function		VFOF	Elbow outlet	QS-6, QS-8	G ¹ / ₈ , G ¹ / ₄	250 ... 650	Internal hex	vfof					









1) Standard nominal flow rate in direction of flow control.

2) Only suitable for push-in connector QS.

One-way flow control valves

Product range overview

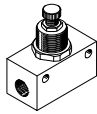
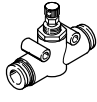
FESTO

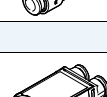
Version	Valve function	Version	Type	Connection direction	Pneumatic connection 1	Pneumatic connection 2	qnN ¹⁾ [l/min]	Adjustment component	→ Page/ Internet
Mini	Metal Exhaust air one-way flow control function		GRLA	Elbow outlet	QS-3, QS-4	M3, M5	40 ... 41	Slotted head screw	26
					M3	M3	0 ... 18	Slotted head screw	29
			GRGA	Parallel outlet	QS-3	M3	0 ... 41	Slotted head screw	26
	Supply air one-way flow control function		GRLZ	Elbow outlet	QS-3, QS-4	M3, M5	41 ... 48	Slotted head screw	26
					M3	M3	0 ... 18	Slotted head screw	29
			GRGZ	Parallel outlet	QS-3	M3	0 ... 41	Slotted head screw	26
In-line installation	One-way flow control function		GR/GRA	Inline	M3, M5, G ¹ / ₈ , G ¹ / ₄ , G ³ / ₈ , G ¹ / ₂ , G ³ / ₄	M3, M5, G ¹ / ₈ , G ¹ / ₄ , G ³ / ₈ , G ¹ / ₂ , G ³ / ₄	29.5 ... 3,300	Knurled screw	gr
			GR	Inline	QS-3, QS-4, QS-6, QS-8	QS-3, QS-4, QS-6, QS-8	40 ... 250	Knurled screw	gr
Corrosion-resistant	Exhaust air one-way flow control function		CRGRLA	Elbow outlet	M5, G ¹ / ₈ , G ¹ / ₄ , G ³ / ₈ , G ¹ / ₂	M5, G ¹ / ₈ , G ¹ / ₄ , G ³ / ₈ , G ¹ / ₂	95 ... 2,100	Slotted head screw	31
Function combination	Exhaust air one-way flow control function		GRXA	Elbow outlet	QS-4, QS-6, QS-8	G ¹ / ₈ , G ¹ / ₄	130 ... 280	Slotted head screw	34
			VFOF	Elbow outlet	QS-6, QS-8	G ¹ / ₈ , G ¹ / ₄	240 ... 590	Internal hex	vfof

1) Standard nominal flow rate in direction of flow control.

One-way flow control valves

Type codes

FESTO

GRLA/GRLSA/GRGA/CRGRLA/GRLZ/GRGZ

GRLA - 1/8 - QS - 6 - - - D

Type	
Exhaust air one-way flow control function	
GRLA	One-way flow control valve, elbow outlet
GRLSA	One-way flow control valve, elbow outlet with rotary knob
GRGA	One-way flow control valve, parallel outlet
CRGRLA	One-way flow control valve, elbow outlet, corrosion-resistant
GRXA-HG	One-way flow control valve, function combination
Supply air one-way flow control function	
GRLZ	One-way flow control valve, elbow outlet
GRGZ	One-way flow control valve, parallel outlet
Pneumatic connection 2	
M3, M5, 1/8, 1/4, 3/8, 1/2, 3/4	Male thread
Pneumatic connection 1	
Connection type	
-	Female thread (connection size as for connection 2)
QS	Push-in connector QS
PK	Barbed connector
Tubing O.D. or tubing I.D.	
3, 4, 6, 8, 10, 12	Tubing O.D. with push-in connector QS
3, 4, 6	Tubing I.D. with barbed connector PK
Adjustment component	
-	Slotted head screw
RS	Knurled screw
Flow rate characteristic	
LF	Low flow
MF	Medium flow
Generation	
B	B series
C	C series
D	D series

One-way flow control valves

Type codes

VOFC

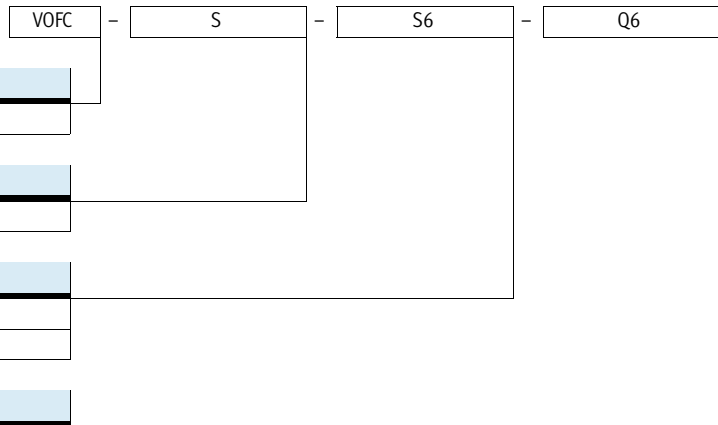

Type	
VOFC	One-way flow control valve, elbow outlet

Valve function	
S	Supply air one-way flow control function

Pneumatic connection 2	
S4	Push-in sleeve QS-4
S6	Push-in sleeve QS-6

Pneumatic connection 1	
Q4	Push-in connector QS-4
Q6	Push-in connector QS-6

VOFH-LE

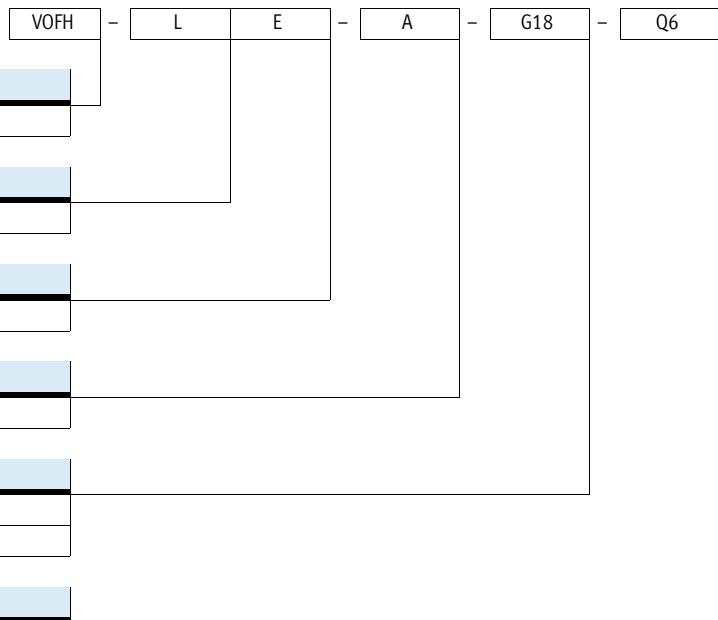

Type	
VOFH	One-way flow control valve

Design	
L	L-shaped outlet

Valve function	
E	Exhaust air one-way flow control function

Adjusting element	
A	External hex

Pneumatic connection 2	
G18	Thread G $\frac{1}{8}$
G14	Thread G $\frac{1}{4}$

Pneumatic connection 1	
Q4	Push-in connector QS-4
Q6	Push-in connector QS-6
Q8	Push-in connector QS-8
Q10	Push-in connector QS-10

One-way flow control valves GRLA/GRLZ, standard

Technical data – Push-in connector QS, metal

One-way flow control function

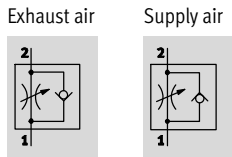

- - Flow rate
100 ... 1,580 l/min
- - Temperature range
-10 ... +60 °C
- - Operating pressure
0.2 ... 10 bar

- Can be swivelled 360° around the screw-in axis after mounting

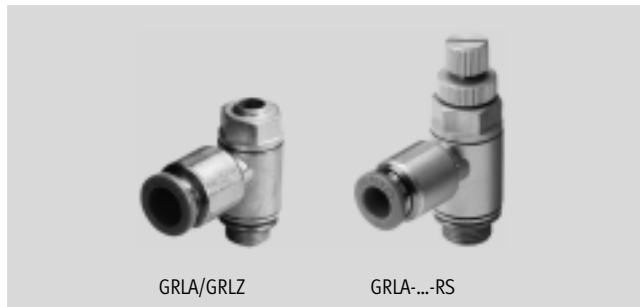

General technical data – GRLA						
Valve function	Exhaust air one-way flow control function					
Pneumatic connection 2	M5	G1/8	G1/4	G3/8	G1/2	
Pneumatic connection 1	QS-3, QS-4, QS-6	QS-3, QS-4, QS-6, QS-8	QS-6, QS-8, QS-10	QS-6, QS-8, QS-10	QS-12	
Adjustment component	Slotted head screw Knurled screw					
Type of mounting	Screw-in, via male thread					
Mounting position	Any					
Nominal tightening torque [Nm]	0.8 ±10%	3 ±10%	5 ±10%	10 ±10%	15 ±10%	

General technical data – GRLZ		
Valve function	Supply air one-way flow control function	
Pneumatic connection 2	M5	G1/8
Pneumatic connection 1	QS-3, QS-4, QS-6	QS-3, QS-4, QS-6, QS-8
Adjustment component	Slotted head screw	
Type of mounting	Screw-in, via male thread	
Mounting position	Any	
Nominal tightening torque [Nm]	0.8 ±10%	3 ±10%

Operating and environmental conditions	
Operating pressure complete	[bar] 0.2 ... 10
temperature range	
Operating medium	Compressed air in accordance with ISO 8573-1:2010 [7:4:4]
Note on operating/pilot medium	Operation with lubricated medium possible (in which case lubricated operation will always be required)
Ambient temperature	[°C] -10 ... +60
Temperature of medium	[°C] -10 ... +60
Storage temperature	[°C] -10 ... +40
Certification	Germanischer Lloyd

Standard nominal flow rate q_{nN} at 6 → 5 bar as a function of turns of the adjusting screw n
GRLA/GRLZ-M5

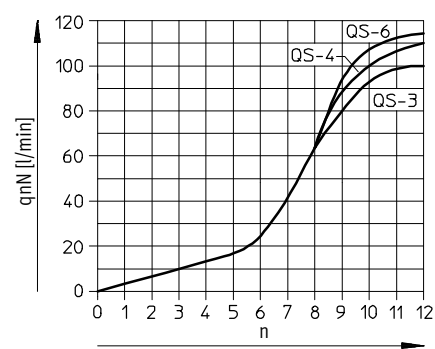

Standard flow rate q_n at 6 → 0 bar as a function of turns of the adjusting screw n
GRLA/GRLZ-M5

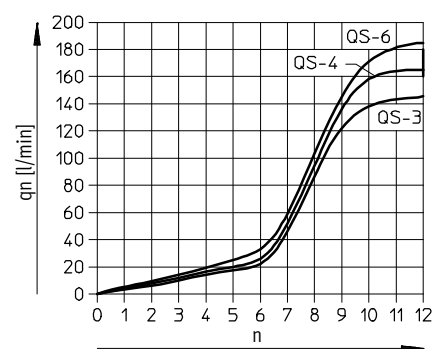

One-way flow control valves GRLA/GRLZ, standard

Technical data – Push-in connector QS, metal

Standard nominal flow rate q_{nN} at 6 \rightarrow 5 bar
as a function of turns of the adjusting screw n

GRLA/GRLZ-1/8

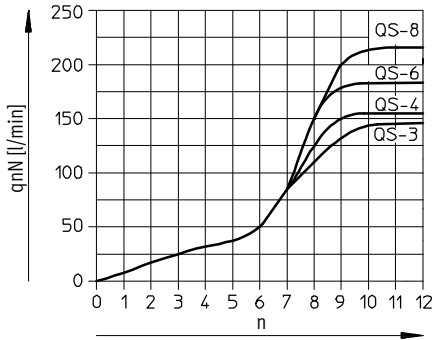

Standard flow rate q_n at 6 \rightarrow 0 bar

as a function of turns of the adjusting screw n

GRLA/GRLZ-1/8

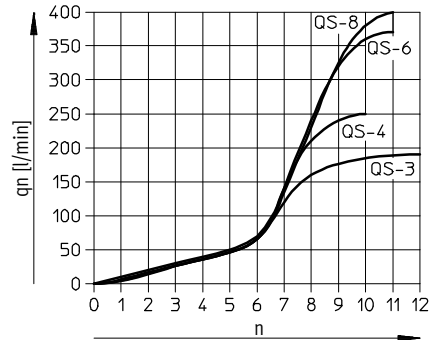

GRLA-1/8...-MF/GRLA-1/4

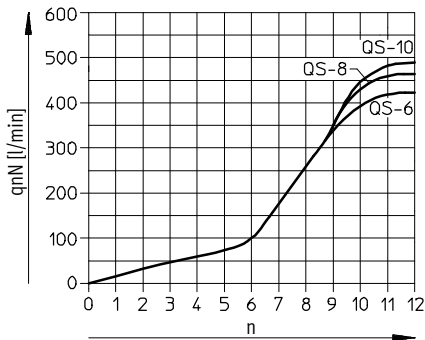

GRLA-1/8...-MF/GRLA-1/4

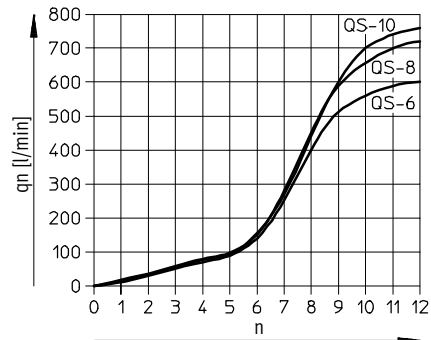

GRLA-3/8

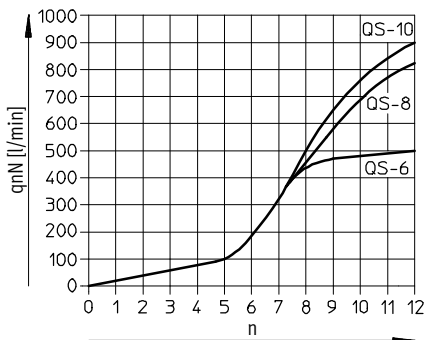

GRLA-3/8

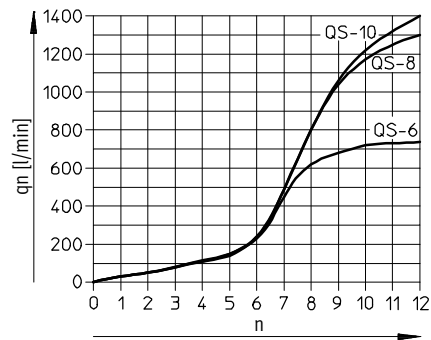

GRLA-1/2

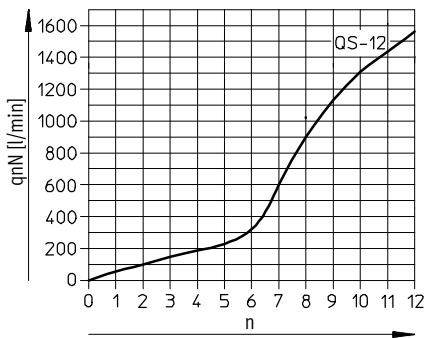

GRLA-1/2

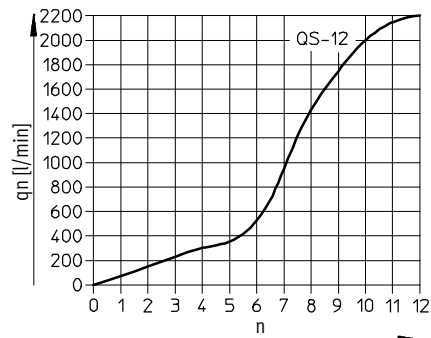

One-way flow control valves GRLA/GRLZ, standard



Technical data – Push-in connector QS, metal

Materials

Sectional view

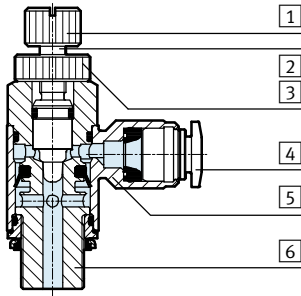

One-way flow control valve

1	Knurled head (only GRLA...-RS)	Anodised wrought aluminium alloy
2	Adjusting screw	Brass
3	Hollow bolt (only GRLA...-RS)	Anodised wrought aluminium alloy
4	Releasing ring	POM
5	Swivel connection	Die-cast zinc, chromed
6	Threaded plug	Wrought aluminium alloy GRLA/GRLZ-M5: Brass
-	Seals	NBR
Note on materials		RoHS-compliant

Dimensions

Download CAD data → www.festo.com

Slotted head screw

Knurled screw

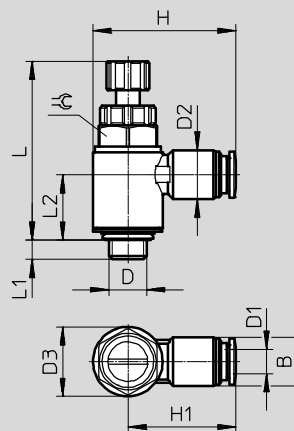
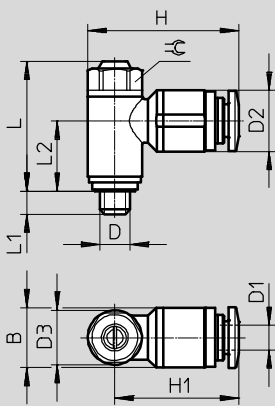

Type	Connection D	Tubing O.D. D1	B	D2 ∅	D3 ∅	H	H1	L		L1	L2	⌀C
								Slotted head screw	Knurled screw			
GRL...-M5	M5	3	-	8.2 +0.15	8.9 ±0.07	22.4	18	~20.45	~30.35	3.9 +0.1/-0.45	~10.7	8
		4	9.8 ±0.2	10.0 ±0.2		24.7	20.3					
		6	-	12.0 ±0.2		26.5	22					
GRL...-1/8	G1/8	3	-	10.2 ±0.2	13.8 ±0.07	31.9	25	~26.7	~40.2	5.05 +0.15/-0.3	~14.2	12
		4		10.2 ±0.2		29.4	22.5					
		6		12.5 ±0.2		32.6	25.7					
GRLA-1/8...-MF	G1/8	8	-	14.5 ±0.2	17.8 ±0.15	35.6	28.7	~31.3	-	5.05 +0.15/-0.3	~17	15
		6	12.5 ±0.2	36.6		27.7						
GRLA-1/4	G1/4	8	-	14.5 ±0.2	17.8 ±0.15	39.6	30.7	~31.5	~48.3	5.9 +0.17/-0.25	~17.2	15
		6		12.5 ±0.2		36.6	27.7					
		10		17.5 ±0.2		42.0	33.1					
GRLA-3/8	G3/8	6	-	12.5 ±0.2	22.4 ±0.15	39.8	28.6	~35.25	~54.55	6.9 +0.15/-0.3	~19.55	19
		8		14.5 ±0.2		44.1	32.9					
		10		17.5 ±0.2		46.7	35.5					
GRLA-1/2	G1/2	12	-	20.5 ±0.15	27.8 ±0.15	55.3	41.4	~42.05	~65.45	8.35 +0.15/-0.3	~22.75	24

One-way flow control valves GRLA/GRLZ, standard

FESTO

Technical data – Push-in connector QS, metal

★ Core product range

Ordering data – Exhaust air one-way flow control function									
Pneumatic connection	Standard nominal flow rate q _{nN} at 6 \rightarrow 5 bar			Standard flow rate q _n at 6 \rightarrow 0 bar		Weight [g]	Part No.	Type	
	in direction of flow control		in non-return direction	in direction of flow control					in non-return direction
	2	1	[l/min]	[l/min]	[l/min]				[l/min]

Slotted head screw									
	M5	QS-3	100	60 ... 100	145	150 ... 170	13	★ 193137	GRLA-M5-QS-3-D
		QS-4	110	65 ... 110	165	140 ... 160		★ 193138	GRLA-M5-QS-4-D
		QS-6	115	70 ... 110	185	145 ... 170		★ 193139	GRLA-M5-QS-6-D
	G1/8	QS-3	130	100 ... 130	180	200 ... 220	22	★ 193142	GRLA-1/8-QS-3-D
		QS-4	160	120 ... 190	250	270 ... 300		★ 193143	GRLA-1/8-QS-4-D
		QS-6	185	160 ... 240	370	330 ... 390		★ 193144	GRLA-1/8-QS-6-D
		QS-8	400	290 ... 420	600	570 ... 680	32	★ 537075	GRLA-1/8-QS-6-MF-D
			215	175 ... 250	400	330 ... 410	22	★ 193145	GRLA-1/8-QS-8-D
			475	325 ... 500	720	610 ... 760	32	★ 537076	GRLA-1/8-QS-8-MF-D
	G1/4	QS-6	400	290 ... 420	600	570 ... 680	42	★ 193146	GRLA-1/4-QS-6-D
		QS-8	475	325 ... 500	720	610 ... 760		★ 193147	GRLA-1/4-QS-8-D
		QS-10	480	345 ... 500	760	630 ... 790		★ 193148	GRLA-1/4-QS-10-D
	G3/8	QS-6	495	320 ... 495	740	840 ... 890	60	★ 193149	GRLA-3/8-QS-6-D
		QS-8	820	450 ... 850	1,300	1,080 ... 1,420		★ 193150	GRLA-3/8-QS-8-D
		QS-10	900	540 ... 975	1,400	1,160 ... 1,620		★ 193151	GRLA-3/8-QS-10-D
	G1/2	QS-12	1,580	925 ... 1,605	2,220	1,910 ... 2,500	106	★ 193152	GRLA-1/2-QS-12-D

Knurled screw									
	M5	QS-3	100	60 ... 100	145	150 ... 170	14	★ 197576	GRLA-M5-QS-3-RS-D
		QS-4	110	65 ... 110	165	140 ... 160		★ 197577	GRLA-M5-QS-4-RS-D
		QS-6	115	70 ... 110	185	145 ... 170		★ 197578	GRLA-M5-QS-6-RS-D
	G1/8	QS-3	130	100 ... 130	180	200 ... 220	23	★ 197579	GRLA-1/8-QS-3-RS-D
		QS-4	160	120 ... 190	250	270 ... 300		★ 197580	GRLA-1/8-QS-4-RS-D
		QS-6	185	160 ... 240	370	330 ... 390		★ 197581	GRLA-1/8-QS-6-RS-D
		QS-8	215	175 ... 250	400	330 ... 410	24	★ 534337	GRLA-1/8-QS-8-RS-D
	G1/4	QS-6	400	290 ... 420	600	570 ... 680	50	★ 534338	GRLA-1/4-QS-6-RS-D
		QS-8	475	325 ... 500	720	610 ... 760		★ 534339	GRLA-1/4-QS-8-RS-D
		QS-10	480	345 ... 500	760	630 ... 790		★ 534340	GRLA-1/4-QS-10-RS-D
	G3/8	QS-6	495	320 ... 495	740	840 ... 890	72	★ 534341	GRLA-3/8-QS-6-RS-D
		QS-8	820	450 ... 850	1,300	1,080 ... 1,420		★ 534342	GRLA-3/8-QS-8-RS-D
		QS-10	900	540 ... 975	1,400	1,160 ... 1,620		★ 534343	GRLA-3/8-QS-10-RS-D
	G1/2	QS-12	1,580	925 ... 1,605	2,220	1,910 ... 2,500	124	★ 534344	GRLA-1/2-QS-12-RS-D

Ordering data – Supply air one-way flow control function									
Pneumatic connection	Standard nominal flow rate q _{nN} at 6 \rightarrow 5 bar			Standard flow rate q _n at 6 \rightarrow 0 bar		Weight [g]	Part No.	Type	
	in direction of flow control		in non-return direction	in direction of flow control					in non-return direction
	2	1	[l/min]	[l/min]	[l/min]				[l/min]

Slotted head screw									
	M5	QS-3	100	60 ... 100	135	130 ... 160	13	★ 193153	GRLZ-M5-QS-3-D
		QS-4	110	65 ... 110	160	150 ... 180		★ 193154	GRLZ-M5-QS-4-D
		QS-6	115	70 ... 110	170	160 ... 200		★ 193155	GRLZ-M5-QS-6-D
	G1/8	QS-3	130	100 ... 130	200	180 ... 200	22	★ 193156	GRLZ-1/8-QS-3-D
		QS-4	160	120 ... 190	300	260 ... 290		★ 193157	GRLZ-1/8-QS-4-D
		QS-6	185	160 ... 240	340	390 ... 460		★ 193158	GRLZ-1/8-QS-6-D
		QS-8	215	175 ... 250	370	390 ... 470	★ 193159	GRLZ-1/8-QS-8-D	

Festo core product range

- ★ Ready for dispatch from the Festo factory in 24 hours
- ☆ Ready for dispatch in 5 days maximum from stock

One-way flow control valves GRLA/GRLZ, standard

FESTO

Technical data – Female thread/barbed connector, metal

One-way flow control function

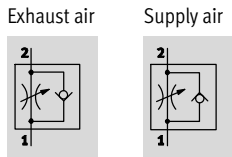

- - Flow rate
83 ... 4,320 l/min
- - Temperature range
-10 ... +60 °C
- - Operating pressure
0.2 ... 10 bar



General technical data – GRLA									
Valve function	Exhaust air one-way flow control function								
Connection type	Female thread						Barbed connector		
Pneumatic connection 2	M5	G1/8	G1/4	G3/8	G1/2	G3/4	M5	G1/8	G1/4
Pneumatic connection 1	M5 ¹⁾	G1/8 ¹⁾	G1/4 ¹⁾	G3/8 ¹⁾	G1/2 ¹⁾	G3/4 ¹⁾	PK-3, PK-4	PK-3, PK-4, PK-6	PK-4, PK-6
Adjustment component	Slotted head screw								
	Knurled screw			-					
Type of mounting	Screw-in								
Mounting position	Any								
Max. tightening torque [Nm]	1.5	6	11	20	40	60	1.5	6	11

1) - - Note: This product conforms to ISO 1179-1 and ISO 228-1.

General technical data – GRLZ									
Valve function	Supply air one-way flow control function								
Connection type	Female thread						Barbed connector		
Pneumatic connection 2	M5	G1/8	G1/4				M5	G1/8	G1/4
Pneumatic connection 1	M5 ¹⁾	G1/8 ¹⁾	G1/4 ¹⁾				PK-3, PK-4	PK-3, PK-4, PK-6	PK-4, PK-6
Adjustment component	Slotted head screw								
	Knurled screw			-					
Type of mounting	Screw-in								
Mounting position	Any								
Max. tightening torque [Nm]	1.5	6	11				1.5	6	11

1) - - Note: This product conforms to ISO 1179-1 and ISO 228-1.

Operating and environmental conditions						
Pneumatic connection 2	M5	G1/8	G1/4	G3/8	G1/2	G3/4
Operating pressure complete [bar]	0.2 ... 10		0.3 ... 10			
temperature range						
Operating medium	Compressed air in accordance with ISO 8573-1:2010 [7:4:4]					
Note on operating/pilot medium	Operation with lubricated medium possible (in which case lubricated operation will always be required)					
Ambient temperature [°C]	-10 ... +60					
Temperature of medium [°C]	-10 ... +60					
Storage temperature [°C]	-10 ... +40					
Certification	GRLA: Germanischer Lloyd					

One-way flow control valves GRLA/GRLZ, standard

Technical data – Female thread/barbed connector, metal

Standard nominal flow rate q_{nN} at 6 → 5 bar
as a function of turns of the adjusting screw n

GRLA/GRLZ-M5

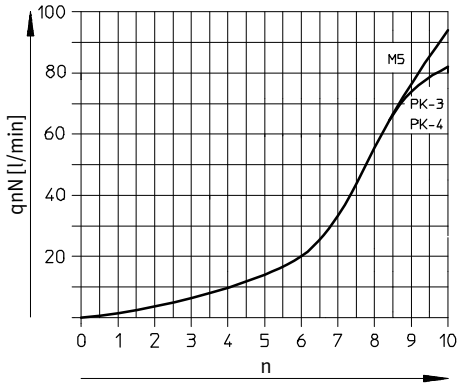

Standard flow rate q_n at 6 → 0 bar
as a function of turns of the adjusting screw n

GRLA/GRLZ-M5

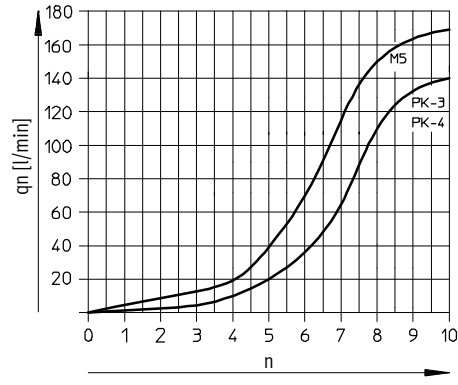

GRLA/GRLZ-1/8

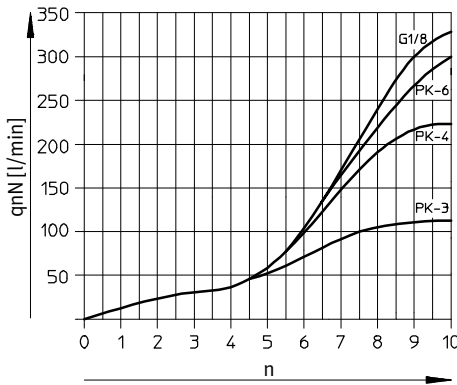

GRLA/GRLZ-1/8

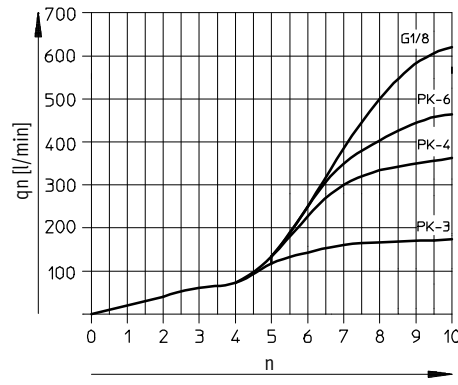

GRLA/GRLZ-1/4

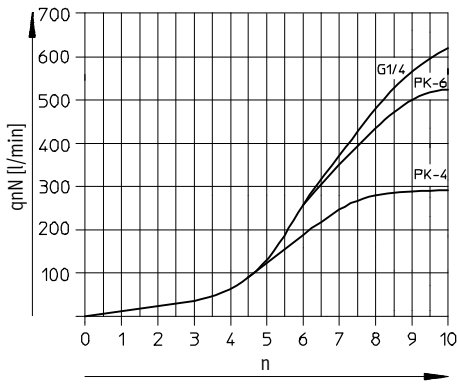

GRLA/GRLZ-1/4

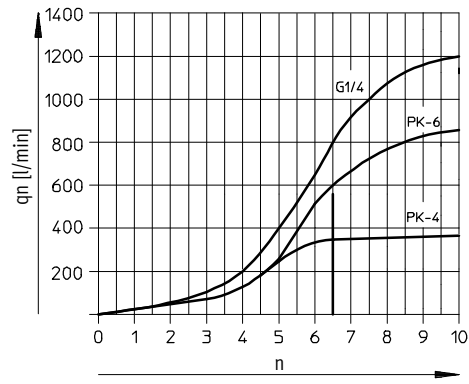

One-way flow control valves GRLA/GRLZ, standard

Technical data – Female thread/barbed connector, metal

FESTO

Standard nominal flow rate q_{nN} at 6 \rightarrow 5 bar
as a function of turns of the adjusting screw n

GRLA- $\frac{3}{8}$

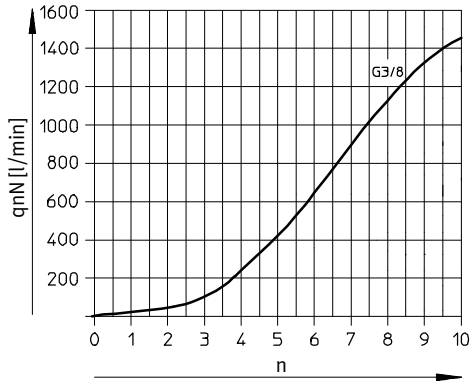

Standard flow rate q_n at 6 \rightarrow 0 bar
as a function of turns of the adjusting screw n

GRLA- $\frac{3}{8}$

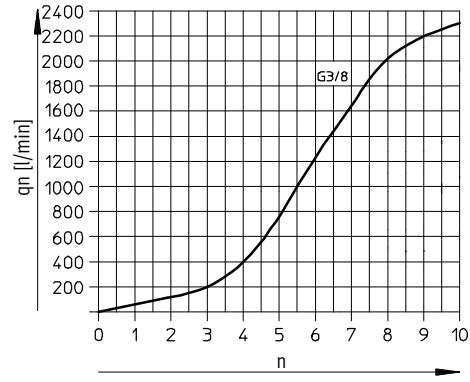

GRLA- $\frac{1}{2}$

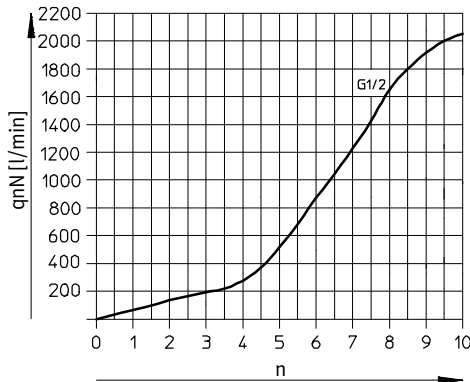

GRLA- $\frac{1}{2}$

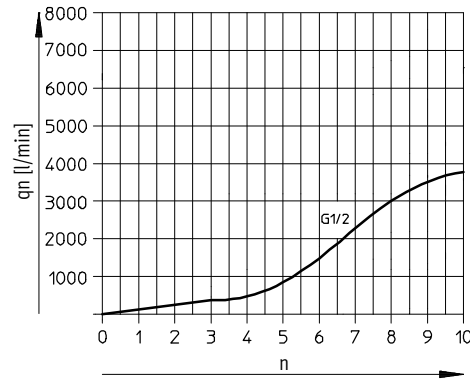

GRLA- $\frac{3}{4}$

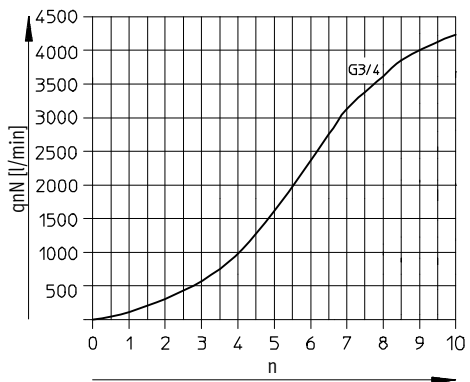

GRLA- $\frac{3}{4}$

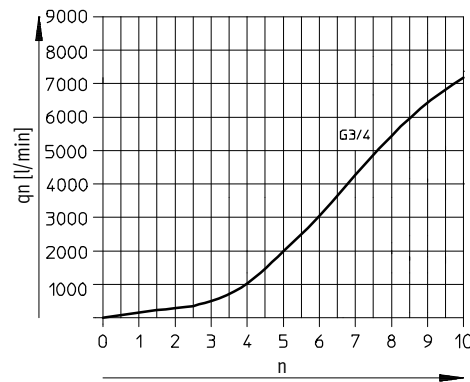

Materials

Sectional view

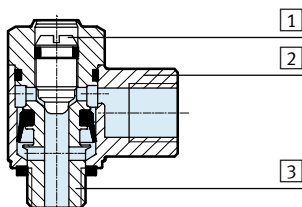

One-way flow control valve

1	Adjusting screw	Brass
2	Swivel connection	Die-cast zinc
3	Threaded plug	Wrought aluminium alloy GRLA/GRLZ-M5: Nickel-plated brass
-	Seals	NBR
Note on materials		RoHS-compliant

One-way flow control valves GRLA/GRLZ, standard

Technical data – Female thread/barbed connector, metal

Dimensions – Female thread connection type Download CAD data → www.festo.com

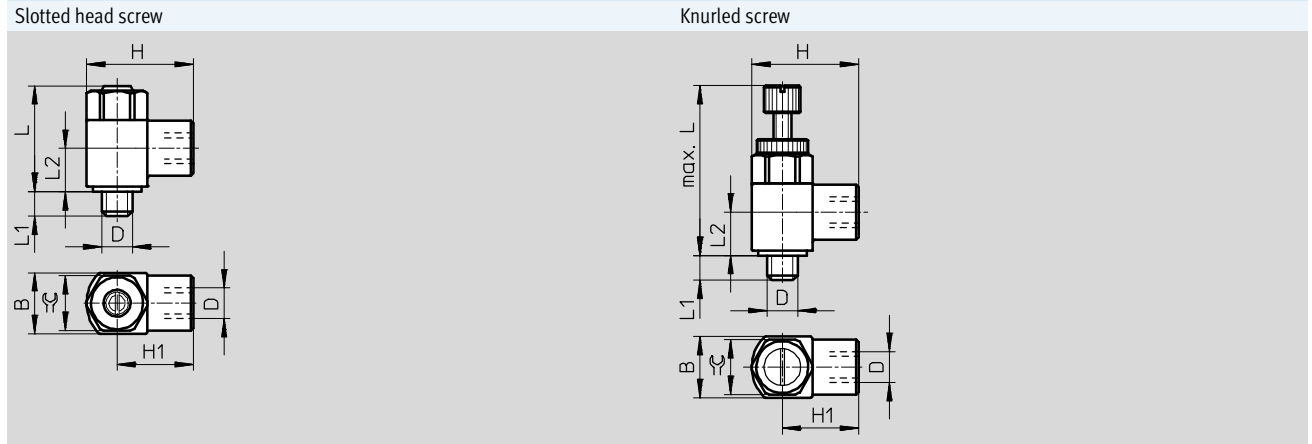

Type	Connection D	Nominal size [mm]	B	H	H1	L		L1	L2	⌀
						Slotted head screw	Knurled screw			
GRL...-M5	M5	2	10 -0.15	17.5	12.5	~17.6	~27.3	4.0 ±0.3	~7.1	9
GRL...-1/8	G1/8	4	16 -0.15	28	20	~25.2	~38.6	5.3 +0.45/-0.35	~10.3	14
GRL...-1/4	G1/4	6	20 -0.2	36	26	~30.8	~54.8	8.2 +0.45/-0.35	~13.2	17
GRLA-3/8	G3/8	8.5	25 -0.2	41	28.5	~37.2	-	8.8 +0.45/-0.35	~15.5	22
GRLA-1/2	G1/2	10.6	32 -0.2	53	37	~48.6	-	12.8 ±0.45	~18.9	27
GRLA-3/4	G3/4	14	41 -0.3	64	43.5	~60.2	-	13.5 ±0.5	~24.5	36

Note: This product conforms to ISO 1179-1 and to ISO 228-1

Dimensions – Barbed connector connection type Download CAD data → www.festo.com

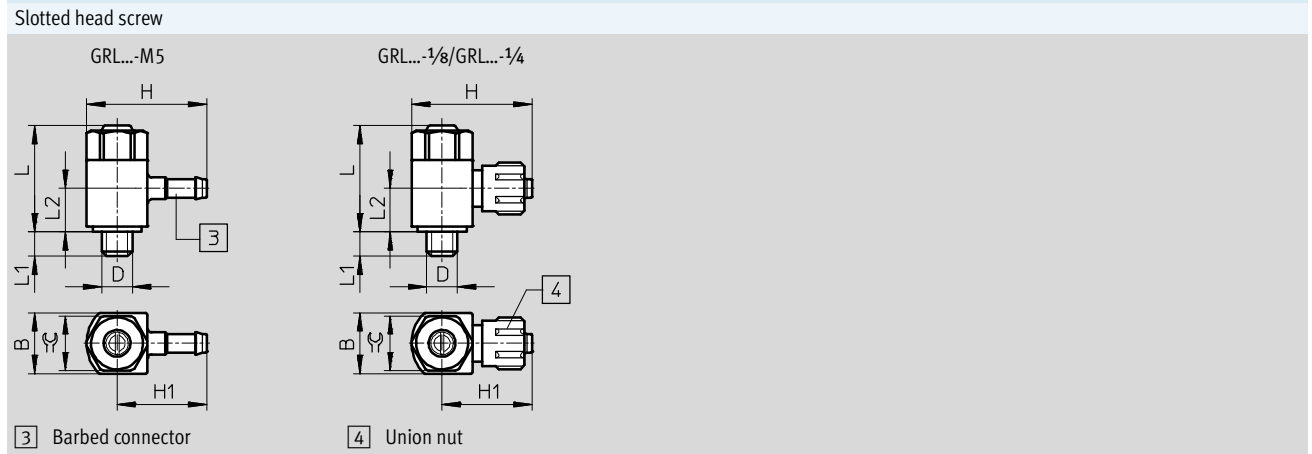



Type	Connection D	Nominal size [mm]	B	H	H1	L	L1	L2	⌀
GRL...-M5-PK-3	M5	2	10 -0.15	19.7	14.7	~17.6	4.0 ±0.3	~8.5	9
GRL...-M5-PK-4			10 -0.15	21.7	16.7	~17.6	4.0 ±0.3	~8.5	9
GRL...-1/8-PK-3	G1/8	4	16 -0.15	27.1	19.1	~25.2	5.3 +0.45/-0.35	~13.4	14
GRL...-1/8-PK-4			16 -0.15	30.2	22.2	~25.2	5.3 +0.45/-0.35	~13.4	14
GRL...-1/8-PK-6			16 -0.15	30.3	22.3	~25.2	5.3 +0.45/-0.35	~12.0	14
GRL...-1/4-PK-4	G1/4	6	20 -0.2	34.2	24.2	~30.8	8.2 +0.45/-0.35	~16.9	17
GRL...-1/4-PK-6			20 -0.2	34.3	24.3	~30.8	8.2 +0.45/-0.35	~17.2	17



One-way flow control valves GRLA/GRLZ, standard

FESTO

Technical data – Female thread/barbed connector, metal

Ordering data – Exhaust air one-way flow control function									
	Pneumatic connection		Standard nominal flow rate q _N at 6 → 5 bar		Standard flow rate q _n at 6 → 0 bar		Weight [g]	Part No.	Type
			in direction of flow control	in non-return direction	in direction of flow control	in non-return direction			
	2	1	[l/min]	[l/min]	[l/min]	[l/min]			
Slotted head screw									
	M5	M5	95	76 ... 95	169	135 ... 170	11	151160	GRLA-M5-B
	G ¹ / ₈	G ¹ / ₈	340	260 ... 420	615	470 ... 760	28	151165	GRLA- ¹ / ₈ -B
	G ¹ / ₄	G ¹ / ₄	610	450 ... 820	1,200	885 ... 1,615	59	151172	GRLA- ¹ / ₄ -B
	G ³ / ₈	G ³ / ₈	1,450	970 ... 1,600	2,300	1,540 ... 2,540	97	151178	GRLA- ³ / ₈ -B
	G ¹ / ₂	G ¹ / ₂	2,100	1,550 ... 2,200	4,000	2,950 ... 4,190	204	151179	GRLA- ¹ / ₂ -B
	G ³ / ₄	G ³ / ₄	4,320	3,220 ... 4,720	7,300	5,440 ... 7,300	377	151180	GRLA- ³ / ₄ -B
	M5	PK-3	83	72 ... 83	140	120 ... 140	10	151161	GRLA-M5-PK-3-B
		PK-4	83	76 ... 88	140	128 ... 148	10	151162	GRLA-M5-PK-4-B
	G ¹ / ₈	PK-3 ¹⁾	110	100 ... 110	162	145 ... 165	22	151166	GRLA- ¹ / ₈ -PK-3-B
		PK-4 ¹⁾	230	190 ... 240	360	295 ... 375	25	151167	GRLA- ¹ / ₈ -PK-4-B
		PK-6 ¹⁾	300	210 ... 290	455	320 ... 440	26	151168	GRLA- ¹ / ₈ -PK-6-B
	G ¹ / ₄	PK-4 ¹⁾	260	220 ... 260	370	315 ... 370	44	151173	GRLA- ¹ / ₄ -PK-4-B
PK-6 ¹⁾		540	410 ... 585	840	635 ... 910	45	151174	GRLA- ¹ / ₄ -PK-6-B	
Knurled screw									
	M5	M5	95	76 ... 95	169	135 ... 170	12	151163	GRLA-M5-RS-B
	G ¹ / ₈	G ¹ / ₈	340	260 ... 420	615	470 ... 760	30	151169	GRLA- ¹ / ₈ -RS-B
	G ¹ / ₄	G ¹ / ₄	610	450 ... 820	1,200	885 ... 1,615	59	151175	GRLA- ¹ / ₄ -RS-B

1) Via union nut

Ordering data – Supply air one-way flow control function									
	Pneumatic connection		Standard nominal flow rate q _N at 6 → 5 bar		Standard flow rate q _n at 6 → 0 bar		Weight [g]	Part No.	Type
			in direction of flow control	in non-return direction	in direction of flow control	in non-return direction			
	2	1	[l/min]	[l/min]	[l/min]	[l/min]			
Slotted head screw									
	M5	M5	95	76 ... 95	169	135 ... 170	11	151183	GRLZ-M5-B
	G ¹ / ₈	G ¹ / ₈	340	260 ... 420	615	470 ... 760	28	151188	GRLZ- ¹ / ₈ -B
	G ¹ / ₄	G ¹ / ₄	610	450 ... 820	1,200	885 ... 1,615	59	151195	GRLZ- ¹ / ₄ -B
	M5	PK-3	83	72 ... 83	140	120 ... 140	10	151184	GRLZ-M5-PK-3-B
		PK-4	83	76 ... 88	140	125 ... 150	10	151185	GRLZ-M5-PK-4-B
	G ¹ / ₈	PK-3 ¹⁾	110	100 ... 110	162	145 ... 165	22	151189	GRLZ- ¹ / ₈ -PK-3-B
		PK-4 ¹⁾	230	190 ... 240	360	295 ... 375	25	151190	GRLZ- ¹ / ₈ -PK-4-B
		PK-6 ¹⁾	300	210 ... 290	455	320 ... 440	26	151191	GRLZ- ¹ / ₈ -PK-6-B
	G ¹ / ₄	PK-4 ¹⁾	260	220 ... 260	370	315 ... 370	44	151196	GRLZ- ¹ / ₄ -PK-4-B
PK-6 ¹⁾		540	410 ... 585	840	635 ... 910	45	151197	GRLZ- ¹ / ₄ -PK-6-B	
Knurled screw									
	M5	M5	95	76 ... 95	169	135 ... 170	12	151186	GRLZ-M5-RS-B
	G ¹ / ₈	G ¹ / ₈	340	260 ... 420	615	470 ... 760	30	151192	GRLZ- ¹ / ₈ -RS-B
	G ¹ / ₄	G ¹ / ₄	610	450 ... 820	1,200	885 ... 1,615	59	151198	GRLZ- ¹ / ₄ -RS-B



1) Via union nut

One-way flow control valves GRLSA, standard

Technical data – Push-in connector QS, metal

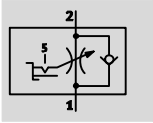
One-way flow control function
Exhaust air



-  Flow rate
0 ... 450 l/min
-  Temperature range
-10 ... +60 °C
-  Operating pressure
0.2 ... 10 bar



This one-way flow control valve offers the ideal conditions for optimum and easy setting of the flow rate in a unique design.

There are two setting options:

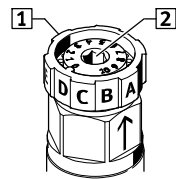

1 Gradual for preselection of the flow range in 5 stages via rotary switch: A, B, C, D, E

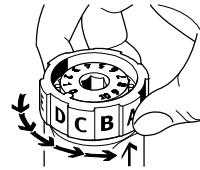

2 Infinitely variable for precision adjustment using internal hex via a scale marked from 0 to 10

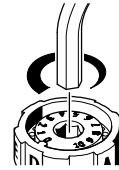

General technical data		
Valve function	Exhaust air one-way flow control function	
Pneumatic connection 2	G1/8	G1/4
Pneumatic connection 1	QS-6	QS-8
Adjustment component	Rotary knob with scale and internal hex	
Actuation type	Manual	
Type of mounting	Screw-in	
Mounting position	Any	
Nominal tightening torque [Nm]	3.5 ±20%	11 ±10%

Operating and environmental conditions		
Operating pressure complete temperature range [bar]	0.2 ... 10	
Operating medium	Compressed air in accordance with ISO 8573-1:2010 [7:4:4]	
Note on operating/pilot medium	Operation with lubricated medium possible (in which case lubricated operation will always be required)	
Ambient temperature [°C]	-10 ... +60	
Temperature of medium [°C]	-10 ... +60	
Storage temperature [°C]	-10 ... +40	

One-way flow control valves GRLSA, standard

Technical data – Push-in connector QS, metal



Standard nominal flow rate q_{nN} at 6 → 5 bar
as a function of the position of the flow control screw (scale) n
GRLSA-1/8

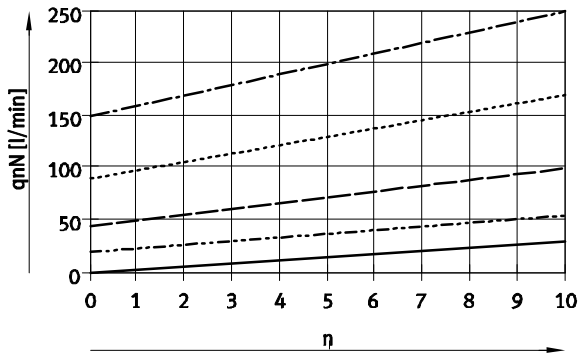

Standard flow rate q_n at 6 → 0 bar
as a function of the position of the flow control screw (scale) n
GRLSA-1/8

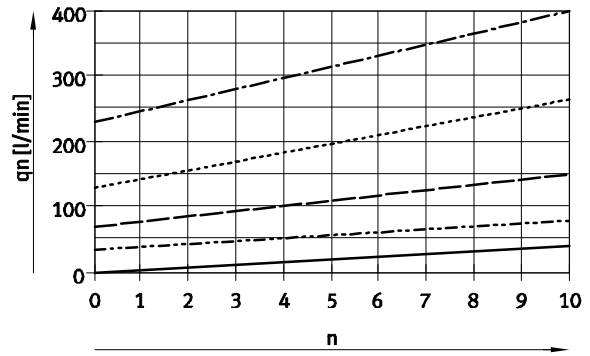

GRLSA-1/4

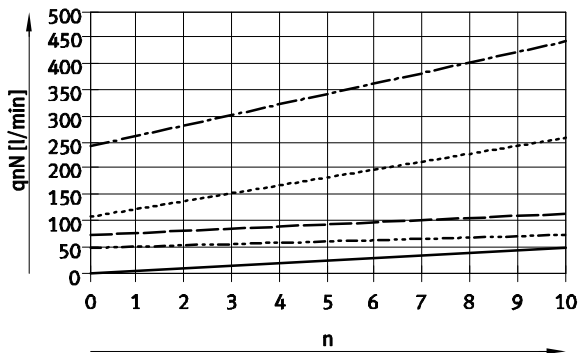

GRLSA-1/4

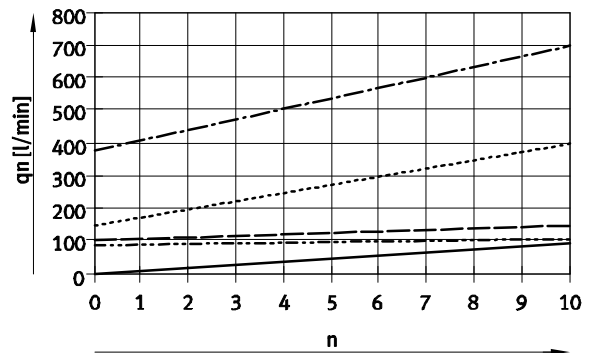

- Stage: A
 - - - Stage: B
 - Stage: C
 - - - Stage: D
 - · - Stage: E
- Flow rate value tolerance: ±20%

Materials

Sectional view

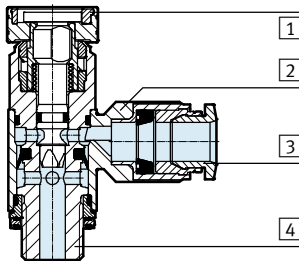

One-way flow control valve

1	Adjusting screw	PA, reinforced
2	Swivel connection	Die-cast zinc
3	Releasing ring	POM
4	Hollow bolt	Anodised wrought aluminium alloy
-	Seals	NBR
Note on materials		RoHS-compliant
		Free of copper and PTFE

One-way flow control valves GRLSA, standard

Technical data – Push-in connector QS, metal

Dimensions

Download CAD data → www.festo.com

Rotary knob with scale and internal hex

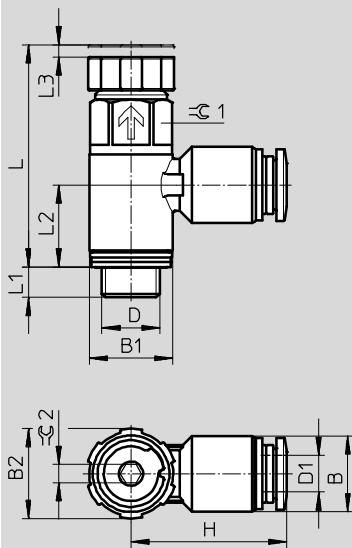

Type	Connection	Tubing O.D.	B	B1	B2	H	L	L1	L2	L3	≙C1	≙C2
	D	D1										
GRLSA-1/8	G1/8	6	12.5	13.8	15	25.7	36.6	5.1	13.5	2	12	3
GRLSA-1/4	G1/4	8	14.5	17.8	18.8	30.75	46.5	7	17.2	3	15	3

Ordering data – Exhaust air one-way flow control function

	Pneumatic connection		Standard nominal flow rate qnN at 6 → 5 bar		Standard flow rate qn at 6 → 0 bar		Weight [g]	Part No.	Type
			in direction of flow control	in non-return direction	in direction of flow control	in non-return direction			
	2	1	[l/min]	[l/min]	[l/min]	[l/min]			
Rotary knob with scale and internal hex									
	G1/8	QS-6	0 ... 250	180 ... 310	0 ... 410	430 ... 540	19.5	540661	GRLSA-1/8-QS-6
	G1/4	QS-8	0 ... 450	390 ... 570	0 ... 700	820 ... 930	34.8	540662	GRLSA-1/4-QS-8



One-way flow control valves VFOC, standard

Technical data – Push-in connector QS, metal

FESTO

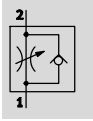
One-way flow control function
Supply air



-  - Flow rate
0 ... 270 l/min
-  - Temperature range
-10 ... +60 °C
-  - Operating pressure
0.2 ... 10 bar



General technical data		
Valve function	Supply air one-way flow control function	
Pneumatic connection 2	Push-in sleeve QS-4	Push-in sleeve QS-6
Pneumatic connection 1	QS-4	QS-6
Note on the pneumatic connection 2	Only suitable for push-in connector QS from Festo	
Adjustment component	Slotted head screw	
Actuation type	Manual	
Type of mounting	Plug-in, with push-in sleeve	
Mounting position	Any	

Operating and environmental conditions		
Operating pressure [bar]	0.2 ... 10	
Operating medium	Compressed air in accordance with ISO 8573-1:2010 [7:4:4]	
Note on operating/pilot medium	Operation with lubricated medium possible (in which case lubricated operation will always be required)	
Ambient temperature [°C]	-10 ... +60	
Temperature of medium [°C]	-10 ... +60	
Storage temperature [°C]	-10 ... +40	

Standard nominal flow rate q_{nN} at 6 → 5 bar as a function of turns of the adjusting screw n

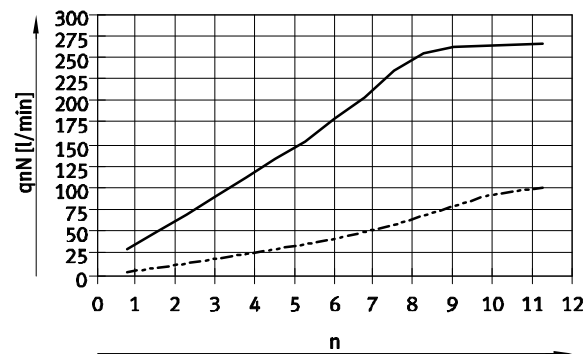

— QS-6
- - - QS-4

Standard flow rate q_n at 6 → 0 bar as a function of turns of the adjusting screw n

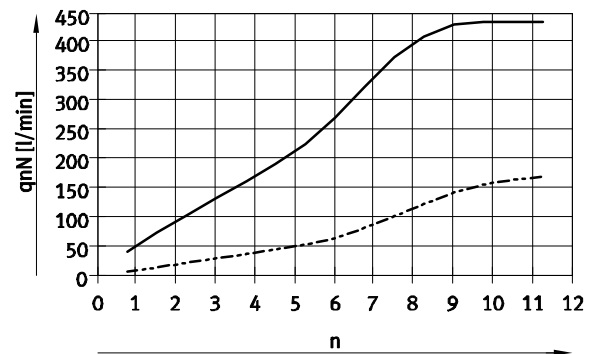

— QS-6
- - - QS-4

One-way flow control valves VFOC, standard

Technical data – Push-in connector QS, metal

Materials

Sectional view

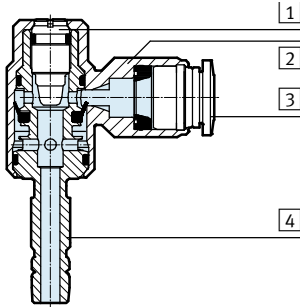

One-way flow control valve

1	Adjusting screw	High-alloy stainless steel
2	Swivel connection	Die-cast zinc
3	Releasing ring	POM
4	Hollow bolt	Black anodised wrought aluminium alloy
-	Seals	NBR
Note on materials		RoHS-compliant

Dimensions

Download CAD data → www.festo.com

Slotted head screw

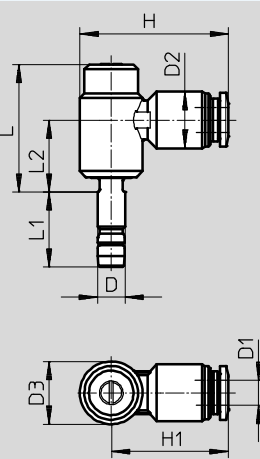

Note

The push-in sleeves of the one-way flow control valves VFOC are exclusively matched to push-in fittings QS from Festo

→ www.festo.com/catalogue

This combination alone guarantees a secure grip in the push-in fitting.

Type	Push-in sleeve Ø D	Tubing O.D. D1	D2 Ø	D3 Ø	H	H1	L	L1	L2
VFOC-S-S4-Q4	4	4	10	8.9	24.7	20.3	~23.2	14.8	~13.2
VFOC-S-S6-Q6	6	6	12.5	13.8	32.6	25.7	~28	16.5	~15.8

Ordering data – Supply air one-way flow control function

	Pneumatic connection		Standard nominal flow rate q _{nN} at 6 → 5 bar		Standard flow rate q _n at 6 → 0 bar		Weight [g]	Part No.	Type
			in direction of flow control	in non-return direction	in direction of flow control	in non-return direction			
	2	1	[l/min]	[l/min]	[l/min]	[l/min]			
	Push-in sleeve QS-4	QS-4	0 ... 100	60 ... 100	0 ... 170	130 ... 160	9.2	559723	VFOC-S-S4-Q4
	Push-in sleeve QS-6	QS-6	0 ... 270	170 ... 260	0 ... 430	330 ... 400	21.6	559724	VFOC-S-S6-Q6

One-way flow control valves VFOH-LE, standard

Technical data – Push-in connector QS, nickel-plated metal



One-way flow control function
Exhaust air

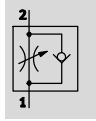

- - Flow rate
180 ... 530 l/min
- - Temperature range
0 ... +150 °C
- - Operating pressure
0.2 ... 10 bar

- 360° orientable around the screw-in axis after mounting



General technical data		
Valve function	Exhaust air one-way flow control function	
Pneumatic connection 2	G1/8	G1/4
Pneumatic connection 1	QS-4, QS-6, QS-8	QS-8, QS-10
Adjustment element	External hex	
Actuation type	Manual	
Type of mounting	Screw-in	
Mounting position	Any	
Nominal tightening torque [Nm]	3 ±10%	5 ±10%

Operating and environmental conditions	
Operating pressure complete [bar]	0.2 ... 10
temperature range	
Operating medium	Compressed air in accordance with ISO 8573-1:2010 [7:4:4]
Note on operating/pilot medium	Operation with lubricated medium possible (in which case lubricated operation will always be required)
Ambient temperature [°C]	0 ... +150
Temperature of medium [°C]	0 ... +150
Storage temperature [°C]	-10 ... +150
Corrosion resistance class CRC ¹⁾	3

1) CRC3: Corrosion resistance class to Festo standard 940 070
Components with heavy corrosion exposure. Externally visible components in direct contact with normal industrial atmosphere or media such as solvents and cleaning agents, where the surface requirement is predominantly functional.

Standard nominal flow rate q_{nN} at 6 → 5 bar as a function of turns of the adjusting screw n

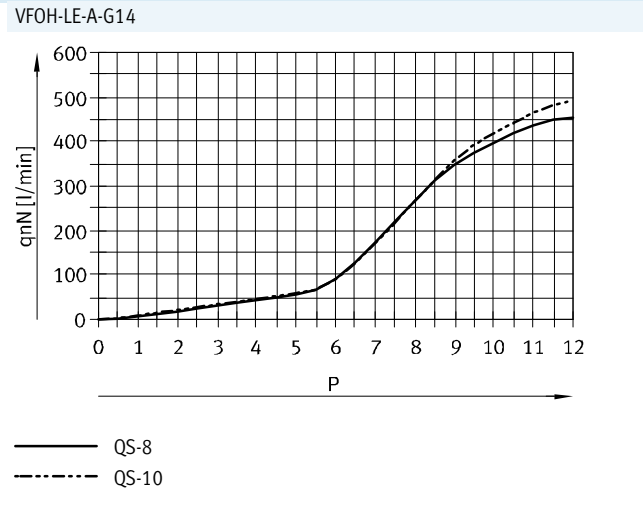
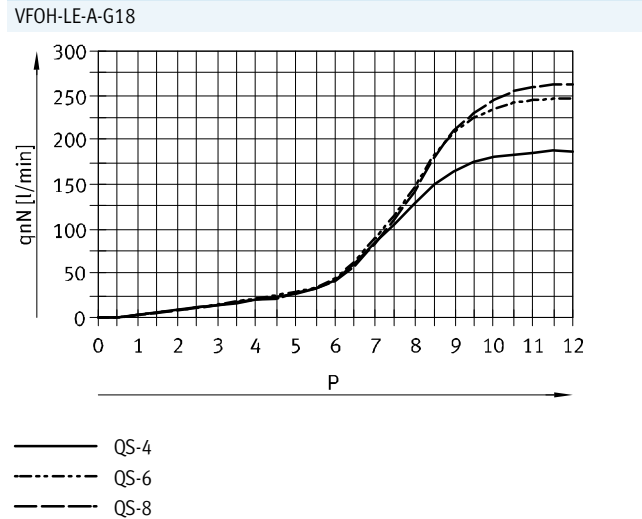

One-way flow control valves VFOH-LE, standard

Technical data – Push-in connector QS, nickel-plated metal

Materials

Sectional view

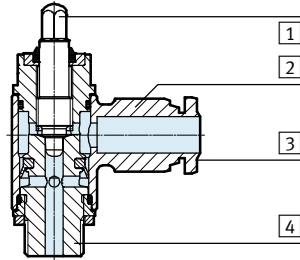

One-way flow control valve

1	Adjusting screw	High-alloy stainless steel
2	Swivel connection	Nickel-plated brass
3	Releasing ring	Nickel-plated brass
4	Hollow bolt	Wrought aluminium alloy
-	Seals	FPM
Note on materials		RoHS-compliant
		Free of copper and PTFE

Dimensions

Download CAD data → www.festo.com

External hex

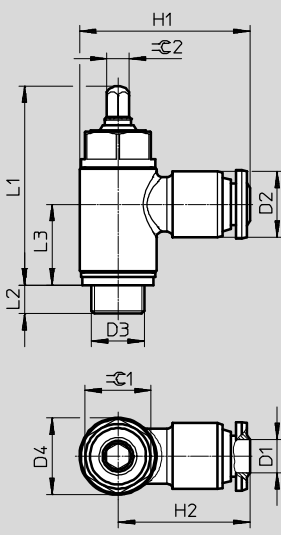

Type	Connection	Tubing O.D.	D2 ∅	D4 ∅	H1	H2	L1	L2	L3	⌀1	⌀2
	D3	D1									
VFOH-LE-A-G18	G1/8	4	10.5	14	28	21	~36.3	~5.2	~14.8	12	4
		6	12		31	24					
		8	14		32	25					
VFOH-LE-A-G14	G1/4	8	14	18	36	27	~39.9	~6.1	~17.5	15	5
		10	17.7		41	32					

Ordering data – Exhaust air one-way flow control function

Pneumatic connection	Standard nominal flow rate qnN at 6 → 5 bar		Standard flow rate qn at 6 → 0 bar		Weight [g]	Part No.	Type		
	2	1	in direction of flow control [l/min]	in non-return direction [l/min]				in direction of flow control [l/min]	in non-return direction [l/min]
	G1/8	QS-4	180	103 ... 188	250	270 ... 300	25	578797	VFOH-LE-A-G18-Q4
		QS-6	255	111 ... 280	370	330 ... 390		578798	VFOH-LE-A-G18-Q6
		QS-8	275	132 ... 307	400	330 ... 410		578799	VFOH-LE-A-G18-Q8
	G1/4	QS-8	530	402 ... 578	720	610 ... 760	37	578800	VFOH-LE-A-G14-Q8
QS-10		520	345 ... 535	840	635 ... 790	48		578801	VFOH-LE-A-G14-Q10



One-way flow control valves GRLA, standard

Technical data – Push-in connector QS, polymer

FESTO

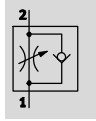
One-way flow control function
Exhaust air



-  - Flow rate
520 ... 650 l/min
-  - Temperature range
-10 ... +60 °C
-  - Operating pressure
0.2 ... 10 bar

- Can be swivelled 360° around the screw-in axis after mounting



General technical data			
Valve function	Exhaust air one-way flow control function		
Pneumatic connection 2	G1/8	G1/4	G3/8
Pneumatic connection 1	QS-6, QS-8	QS-6, QS-8	QS-6, QS-8
Adjustment component	Knurled screw		
Actuation type	Manual		
Type of mounting	Screw-in		
Mounting position	Any		
Nominal tightening torque [Nm]	3.5 ±20%	11 ±10%	12.5 ±20%
Perm. actuation torque for regulating screw [Nm]	0.4		

Operating and environmental conditions	
Operating pressure complete temperature range [bar]	0.2 ... 10
Operating medium	Compressed air in accordance with ISO 8573-1:2010 [7:4:4]
Note on operating/pilot medium	Operation with lubricated medium possible (in which case lubricated operation will always be required)
Ambient temperature [°C]	-10 ... +60
Temperature of medium [°C]	-10 ... +60
Storage temperature [°C]	-10 ... +40
Corrosion resistance class CRC ¹⁾	2

1) Corrosion resistance class CRC 2 to Festo standard FN 940070

Moderate corrosion stress. Indoor applications in which condensation may occur. External visible parts with primarily decorative requirements for the surface and which are in direct contact with the ambient atmosphere typical for industrial applications.

Standard nominal flow rate q_{nN} at 6 → 5 bar as a function of turns of the adjusting screw n

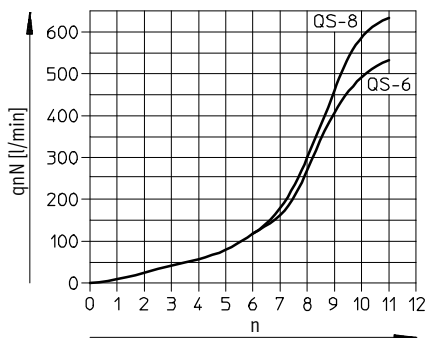

Standard flow rate q_n at 6 → 0 bar as a function of turns of the adjusting screw n

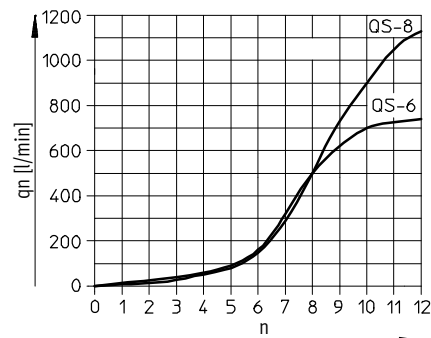

One-way flow control valves GRLA, standard

Technical data – Push-in connector QS, polymer

Materials

Sectional view

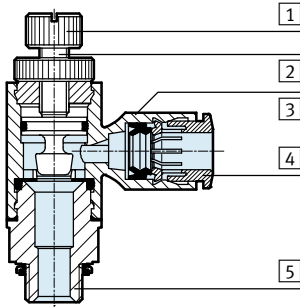

One-way flow control valve

1	Knurled head	Wrought aluminium alloy
2	Regulating screw	Brass
3	Swivel connection	PBT, reinforced
4	Releasing ring	POM
5	Threaded plug	Wrought aluminium alloy
-	Seals	TPE-U(PU) NBR
Note on materials		RoHS-compliant

Dimensions

Download CAD data → www.festo.com

Knurled screw

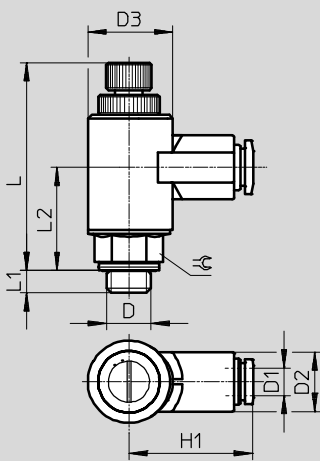

Type	Connection D	Tubing O.D. D1	D2 ∅	D3	H1	L	L1	L2	⊘
GRLA-1/8	G1/8	6	13.0 ±0.25	17.9 -0.1	27.2	~52.8	~4.9	~22.6	13
		8	16.8 ±0.4		35.4				
GRLA-1/4	G1/4	6	13.0 ±0.25	17.9 -0.1	27.2	~53.6	~5.8	~22.3	17
		8	16.8 ±0.4		35.4				
GRLA-3/8	G3/8	6	13.0 ±0.25	17.9 -0.1	27.2	~53.8	~6.8	~22.3	19
		8	16.8 ±0.4		35.4				

Ordering data – Exhaust air one-way flow control function

	Pneumatic connection		Standard nominal flow rate qnN at 6 → 5 bar		Standard flow rate qn at 6 → 0 bar		Weight [g]	Part No.	Type
			in direction of flow control	in non-return direction	in direction of flow control	in non-return direction			
	2	1	[l/min]	[l/min]	[l/min]	[l/min]			
	G1/8	QS-6	520	400 ... 550	720	600 ... 750	25	162965	GRLA-1/8-QS-6-RS-B
		QS-8	650	600 ... 750	1,080	800 ... 1,250		162966	GRLA-1/8-QS-8-RS-B
	G1/4	QS-6	520	400 ... 550	720	600 ... 750	30	162967	GRLA-1/4-QS-6-RS-B
		QS-8	650	600 ... 750	1,130	800 ... 1,250		162968	GRLA-1/4-QS-8-RS-B
	G3/8	QS-6	530	400 ... 550	720	600 ... 750	40	162969	GRLA-3/8-QS-6-RS-B
		QS-8	650	600 ... 750	1,130	800 ... 1,250		162970	GRLA-3/8-QS-8-RS-B

One-way flow control valves GRLA/GRLZ/GRGA/GRGZ, mini

Technical data – Push-in connector QS, metal

One-way flow control function

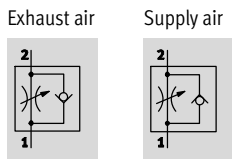

- - Flow rate
40 ... 48 l/min
- - Temperature range
-10 ... +60 °C
- - Operating pressure
0.2 ... 10 bar

- Low flow: precision adjustment for low speed

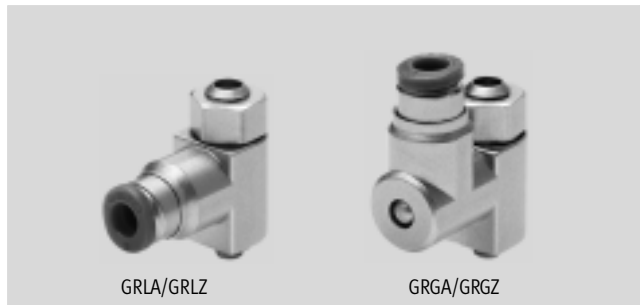

General technical data – GRLA/GRGA		
Valve function	Exhaust air one-way flow control function	
Pneumatic connection 2	M3	M5
Pneumatic connection 1	QS-3	QS-3, QS-4
Adjustment component	Slotted head screw	
Type of mounting	Screw-in	
Mounting position	Any	
Max. tightening torque [Nm]	0.3	1.5

General technical data – GRLZ/GRGZ		
Valve function	Supply air one-way flow control function	
Pneumatic connection 2	M3	M5
Pneumatic connection 1	QS-3	QS-3, QS-4
Adjustment component	Slotted head screw	
Type of mounting	Screw-in	
Mounting position	Any	
Max. tightening torque [Nm]	0.3	1.5

Operating and environmental conditions		
Operating pressure [bar]	0.2 ... 10	
Operating medium	Compressed air in accordance with ISO 8573-1:2010 [7:4:4]	
Note on operating/pilot medium	Operation with lubricated medium possible (in which case lubricated operation will always be required)	
Ambient temperature [°C]	-10 ... +60	
Temperature of medium [°C]	-10 ... +60	
Storage temperature [°C]	-10 ... +40	
Certification	GRLA: Germanischer Lloyd	

One-way flow control valves GRLA/GRLZ/GRGA/GRGZ, mini

Technical data – Push-in connector QS, metal

Standard nominal flow rate q_{nN} at 6 \rightarrow 5 bar as a function of turns of the adjusting screw n
GRLA/GRLZ/GRGA/GRGZ-M3

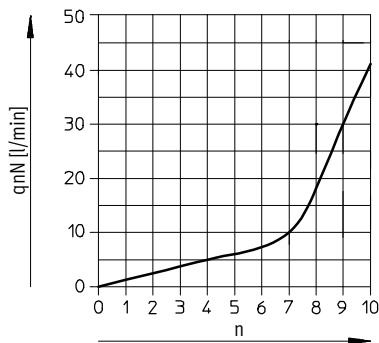

Standard flow rate q_n at 6 \rightarrow 0 bar as a function of turns of the adjusting screw n
GRLA/GRLZ/GRGA/GRGZ-M3

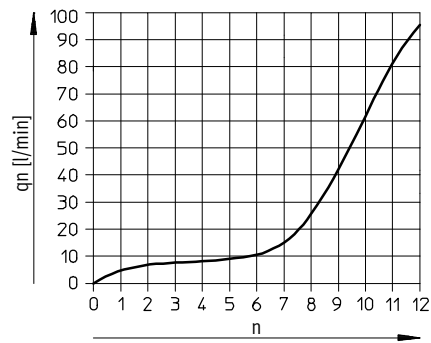

GRLA/GRLZ-M5

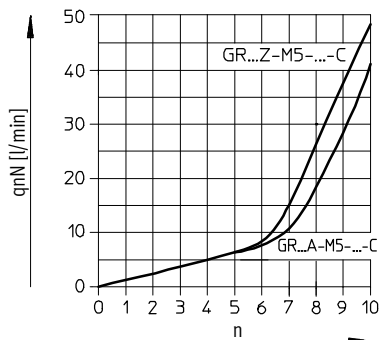

GRLA/GRLZ-M5

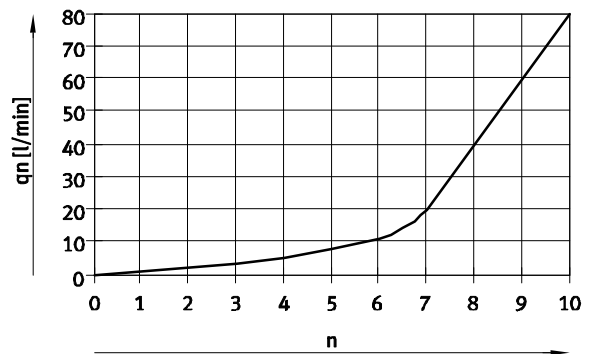

Materials

Sectional view

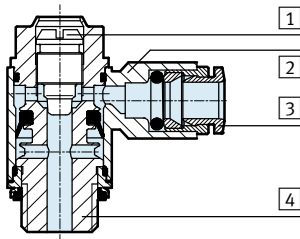

One-way flow control valve

1	Adjusting screw	Brass
2	Swivel connection	Die-cast zinc
3	Releasing ring	POM
4	Threaded plug	Nickel-plated brass
-	Seals	NBR
Note on materials		RoHS-compliant

One-way flow control valves GRLA/GRLZ/GRGA/GRGZ, mini

Technical data – Push-in connector QS, metal

Dimensions Download CAD data → www.festo.com

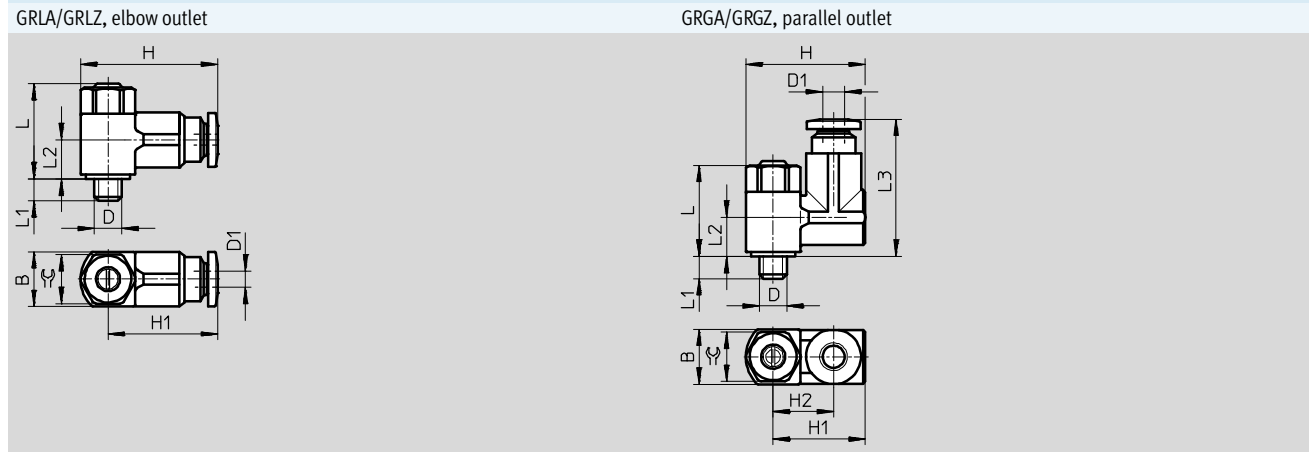

Type	Connection D	Nominal size [mm]	Tubing O.D. D1	B	H	H1	H2	L	L1	L2	L3	⊕
GRLA/GRLZ	M3	1.4	3	8 -0.15	20	15.8	-	~16.6	2.3 +0.15/-0.3	~7	-	7
	M5	1.4	3	9.8 -0.15	22.4	18.4		~17.7	3.1 +0.15/-0.35	~7.3		
		1.4	4	9.8 -0.15	22.2	18.2		~17.7	3.1 +0.15/-0.35	~7.3		
GRGA/GRGZ	M3	1.4	3	8 -0.15	18	14	9.25	~16.6	2.3 +0.15/-0.3	~7.5	22	7

Ordering data – Exhaust air one-way flow control function											
	Pneumatic connection		Standard nominal flow rate qnN at 6 → 5 bar		Standard flow rate qn at 6 → 0 bar		Weight [g]	Part No.	Type		
			in direction of flow control	in non-return direction	in direction of flow control	in non-return direction					
			[l/min]	[l/min]	[l/min]	[l/min]				2	1
Slotted head screw											
	M3	QS-3	41	27 ... 50	95	75 ... 110	7	175041	GRLA-M3-QS-3		
	M5	QS-3	40	46 ... 70	80	90 ... 140	9	175053	GRLA-M5-QS-3-LF-C		
		QS-4	40	50 ... 75	80	100 ... 150	9	175056	GRLA-M5-QS-4-LF-C		
	M3	QS-3	41	27 ... 50	95	75 ... 110	14	175044	GRGA-M3-QS-3		

Ordering data – Supply air one-way flow control function											
	Pneumatic connection		Standard nominal flow rate qnN at 6 → 5 bar		Standard flow rate qn at 6 → 0 bar		Weight [g]	Part No.	Type		
			in direction of flow control	in non-return direction	in direction of flow control	in non-return direction					
			[l/min]	[l/min]	[l/min]	[l/min]				2	1
Slotted head screw											
	M3	QS-3	41	27 ... 44	95	75 ... 100	7	175043	GRLZ-M3-QS-3		
	M5	QS-3	48	36 ... 52	80	60 ... 90	9	175055	GRLZ-M5-QS-3-LF-C		
		QS-4	48	40 ... 65	80	65 ... 110	9	175058	GRLZ-M5-QS-4-LF-C		
	M3	QS-3	41	27 ... 44	95	75 ... 100	14	175046	GRGZ-M3-QS-3		

One-way flow control valves GRLA/GRLZ, mini



Technical data – Female thread, metal

One-way flow control function

Exhaust air

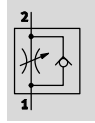
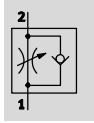
Supply air



-  Flow rate
0 ... 18 l/min
-  Temperature range
-10 ... +60 °C
-  Operating pressure
0.2 ... 10 bar



General technical data – GRLA	
Valve function	Exhaust air one-way flow control function
Pneumatic connection 2	M3
Pneumatic connection 1	M3
Adjustment component	Slotted head screw
Type of mounting	Screw-in
Mounting position	Any
Max. tightening torque [Nm]	0.3

General technical data – GRLZ	
Valve function	Supply air one-way flow control function
Pneumatic connection 2	M3
Pneumatic connection 1	M3
Adjustment component	Slotted head screw
Type of mounting	Screw-in
Mounting position	Any
Max. tightening torque [Nm]	0.3

Operating and environmental conditions	
Operating pressure [bar]	0.2 ... 10
Operating medium	Compressed air in accordance with ISO 8573-1:2010 [7:4:4]
Note on operating/pilot medium	Operation with lubricated medium possible (in which case lubricated operation will always be required)
Ambient temperature [°C]	-10 ... +60
Temperature of medium [°C]	-10 ... +60
Storage temperature [°C]	-10 ... +40
Certification	GRLA: Germanischer Lloyd

Standard nominal flow rate q_{nN} at 6 → 5 bar as a function of turns of the adjusting screw n

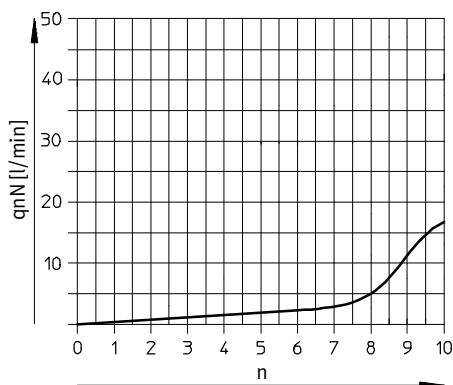

Standard flow rate q_n at 6 → 0 bar as a function of turns of the adjusting screw n

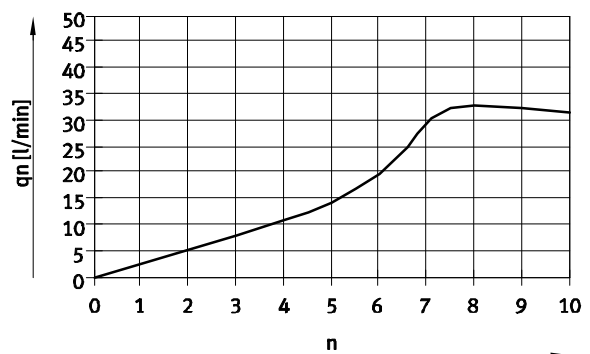

One-way flow control valves GRLA/GRLZ, mini

Technical data – Female thread, metal



Materials

Sectional view

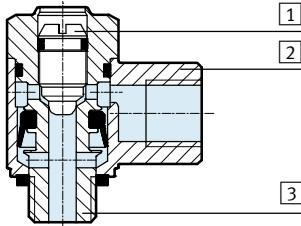

One-way flow control valve

1	Adjusting screw	Brass
2	Swivel connection	Die-cast zinc
3	Threaded plug	Nickel-plated brass
-	Seals	NBR
Note on materials		RoHS-compliant

Dimensions

Download CAD data → www.festo.com

Slotted head screw

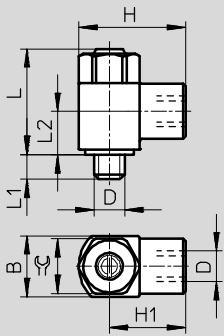

Type	Connection D	Nominal size [mm]	B	H	H1	L	L1	L2	☞
GRLA/GRLZ	M3	0.8	5 -0.1	9	6.5	~13.3	2.5 +0.15/-0.3	~6.4	4.5

Ordering data – Exhaust air one-way flow control function

Pneumatic connection	Standard nominal flow rate qnN at 6 → 5 bar		Standard flow rate qn at 6 → 0 bar		Weight [g]	Part No.	Type
	in direction of flow control	in non-return direction	in direction of flow control	in non-return direction			
	2	1	[l/min]	[l/min]			

Slotted head screw

	M3	M3	18	18 ... 20	33	33 ... 37	2	175038	GRLA-M3
--	----	----	----	-----------	----	-----------	---	---------------	----------------

Ordering data – Supply air one-way flow control function

Pneumatic connection	Standard nominal flow rate qnN at 6 → 5 bar		Standard flow rate qn at 6 → 0 bar		Weight [g]	Part No.	Type
	in direction of flow control	in non-return direction	in direction of flow control	in non-return direction			
	2	1	[l/min]	[l/min]			

Slotted head screw

	M3	M3	18	18 ... 20	33	33 ... 37	2	175040	GRLZ-M3
--	----	----	----	-----------	----	-----------	---	---------------	----------------

One-way flow control valves CRGRLA, corrosion-resistant

Technical data – Female thread, stainless steel

One-way flow control function
Exhaust air

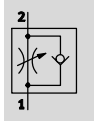

- - Flow rate
95 ... 2,100 l/min
- - Temperature range
-20 ... +80 °C
- - Operating pressure
0.2 ... 10 bar



General technical data						
Valve function		Exhaust air one-way flow control function				
Pneumatic connection 2		M5	G1/8	G1/4	G3/8	G1/2
Pneumatic connection 1		M5	G1/8	G1/4	G3/8	G1/2
Adjustment component		Slotted head screw				
Type of mounting		Screw-in				
Mounting position		Any				
Max. tightening torque	[Nm]	1.5	6	11	20	40
Perm. actuation torque for regulating screw	[Nm]	0.2	0.5	1.5	2	3

-||- Note: This product conforms to ISO 1179-1 and to ISO 228-1

Operating and environmental conditions						
Pneumatic connection 2		M5	G1/8	G1/4	G3/8	G1/2
Operating pressure	[bar]	0.2 ... 10		0.3 ... 10		
Operating medium		Compressed air in accordance with ISO 8573-1:2010 [7:4:4]				
Note on operating/pilot medium		Operation with lubricated medium possible (in which case lubricated operation will always be required)				
Ambient temperature	[°C]	-20 ... +80				
Temperature of medium	[°C]	-10 ... +60				
Storage temperature	[°C]	-10 ... +40				
Corrosion resistance class CRC ¹⁾		3				
Food-safe ²⁾		See supplementary material information				
Approval ²⁾		Germanischer Lloyd				

- 1) Corrosion resistance class CRC 3 to Festo standard FN 940070
High corrosion stress. Outdoor exposure under moderate corrosive conditions. External visible parts with primarily functional requirements for the surface and which are in direct contact with a normal industrial environment.
- 2) Additional information www.festo.com/sp → Certificates.

Standard nominal flow rate q_{nN} at 6 → 5 bar as a function of turns of the adjusting screw n

CRGRLA-M5, CRGRLA-1/8

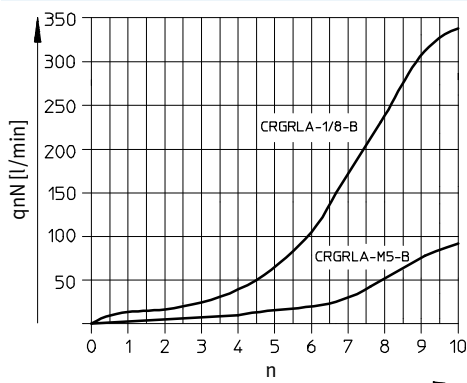

Standard flow rate q_n at 6 → 0 bar as a function of turns of the adjusting screw n

CRGRLA-M5, CRGRLA-1/8

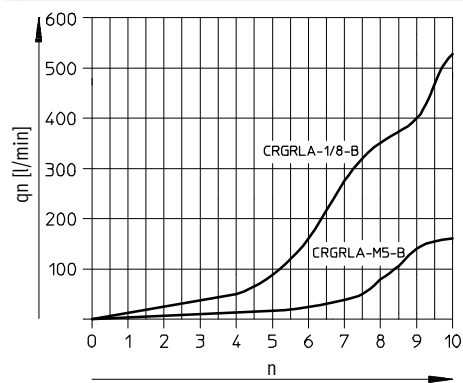

One-way flow control valves CRGRLA, corrosion-resistant

Technical data – Female thread, stainless steel

FESTO

Standard nominal flow rate q_{nN} at 6 \rightarrow 5 bar as a function of turns of the adjusting screw n

CRGRLA-1/4, CRGRLA-3/8, CRGRLA-1/2

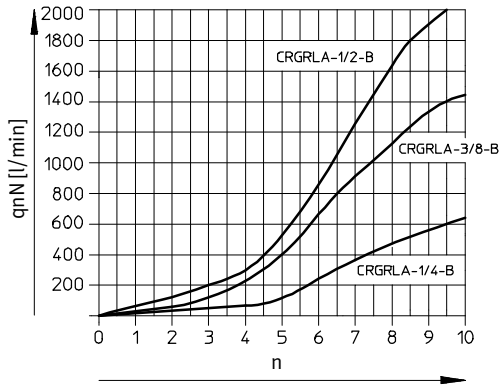

Standard flow rate q_n at 6 \rightarrow 0 bar as a function of turns of the adjusting screw n

CRGRLA-1/4, CRGRLA-3/8, CRGRLA-1/2

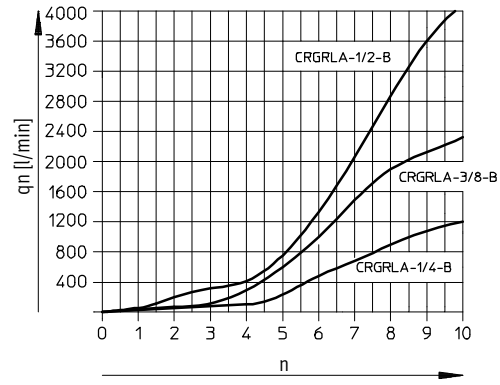

Materials

Sectional view

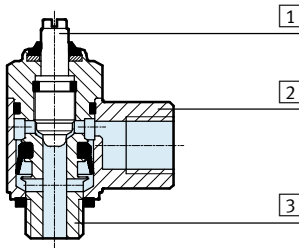

One-way flow control valve

1	Regulating screw	High-alloy stainless steel
2	Swivel connection	High-alloy stainless steel
3	Hollow bolt	High-alloy steel
-	Seals	FPM, PVC
Note on materials		RoHS-compliant

Dimensions

Download CAD data [→ www.festo.com](http://www.festo.com)

CRGRLA-M5

CRGRLA-1/8, CRGRLA-1/4, CRGRLA-3/8, CRGRLA-1/2

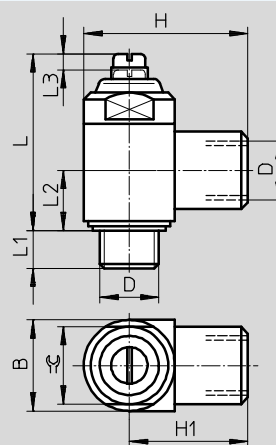
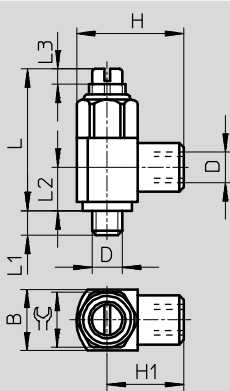

Type	Connection D	Nominal size [mm]	B	H	H1	L	L1	L2	L3	⌀
CRGRLA-M5	M5	2	10 -0.25	17.5 ±0.3	12.5	~23.2	~4	~7.1	~2.5	9
CRGRLA-1/8	G1/8	4	16 -0.4	28 +0.4/-0.3	20	~33.7	~5.5	~10.3	~3.5	14
CRGRLA-1/4	G1/4	6	20 -0.3	36 +0.4/-0.2	26	~38.8	~6.5	~13.2	~3.5	17
CRGRLA-3/8	G3/8	8.5	25 -0.3	41 +0.4/-0.2	28.5	~48.5	~7.5	~15.4	~5	22
CRGRLA-1/2	G1/2	10.6	32 -0.4	53 ±0.5	37	~62.2	~9	~18.9	~7.5	27

Note: This product conforms to ISO 1179-1 and to ISO 228-1

One-way flow control valves CRGRLA, corrosion-resistant

Technical data – Female thread, stainless steel

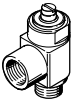
Ordering data – Exhaust air one-way flow control function									
Pneumatic connection		Standard nominal flow rate q _{nN} at 6 $\bar{\rightarrow}$ 5 bar		Standard flow rate q _n at 6 $\bar{\rightarrow}$ 0 bar		Weight [g]	Part No.	Type	
		in direction of flow control	in non-return direction	in direction of flow control	in non-return direction				
2	1	[l/min]	[l/min]	[l/min]	[l/min]				
Slotted head screw									
	M5	M5	95	77 ... 95	165	140 ... 150	10.2	161403	CRGRLA-M5-B
	G1/8	G1/8	340	260 ... 420	580	530 ... 590	37.8	161404	CRGRLA-1/8-B
	G1/4	G1/4	610	450 ... 820	1,265	1,030 ... 1,345	71.6	161405	CRGRLA-1/4-B
	G3/8	G3/8	1,450	970 ... 1,600	2,515	2,095 ... 2,665	126.9	161406	CRGRLA-3/8-B
	G1/2	G1/2	2,100	1,550 ... 2,200	4,265	3,550 ... 4,325	262.3	161407	CRGRLA-1/2-B

- 7 - Type discontinued
Available up until 2019



One-way flow control valves GRXA, function combination

Technical data – Push-in connector QS, metal

FESTO

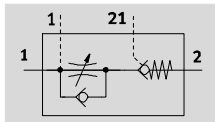
One-way flow control function
Exhaust air



-  - Flow rate
130 ... 280 l/min
-  - Temperature range
-10 ... +60 °C
-  - Operating pressure
0.5 ... 10 bar



Function example:

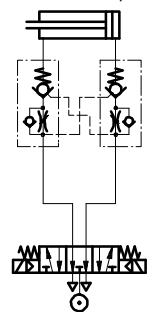

The function combination consists of a one-way flow control valve and a piloted non-return valve. Exhaust air flow control is active as long as a pilot signal from pneumatic connection 21 is applied. If no pilot signal is applied, the valve shuts off the exhaust air. The compressed air flows unthrottled through the non-return valve in the supply air direction.

- Stop function and speed setting in one housing
- Swivel pilot connection 21 perpendicular to screw-in direction
- Additional pilot connection 1 for crossover interconnection, e.g. for stop function with pressure failure
➔ Function example

General technical data			
Valve function		Exhaust air one-way flow control function	
Pneumatic connection 2		G $\frac{1}{8}$	G $\frac{1}{4}$
Pneumatic connection 1		QS-4, QS-6	QS-6, QS-8
Pneumatic connection 21/additional pilot connection 1		QS-4	QS-4
Adjustment component		Slotted head screw	
Actuation type		Pneumatic	
Type of mounting		Screw-in, via male thread	
Mounting position		Any	
Switching time	Off	[ms]	44
	On	[ms]	6
Nominal tightening torque		[Nm]	3.5 ±10%
			11 ±10%

Operating and environmental conditions		
Operating pressure complete	[bar]	0.5 ... 10
temperature range		
Pilot pressure p21	[bar]	2 ... 10
Operating/pilot medium		Compressed air in accordance with ISO 8573-1:2010 [7:4:4]
Note on operating/pilot medium		Operation with lubricated medium possible (in which case lubricated operation will always be required)
Ambient temperature	[°C]	-10 ... +60
Temperature of medium	[°C]	-10 ... +60
Storage temperature	[°C]	-10 ... +40

-  - Note

Additional measures are required for use in safety-related applications; in Europe, for example, the standards listed under the EC Machinery Directive must be observed.

Without additional measures in accordance with statutory minimum requirements, the product is not suitable for use in safety-related sections of control systems.

One-way flow control valves GRXA, function combination

Technical data – Push-in connector QS, metal

Standard nominal flow rate q_{nN} at 6 \rightarrow 5 bar
as a function of turns of the adjusting screw n

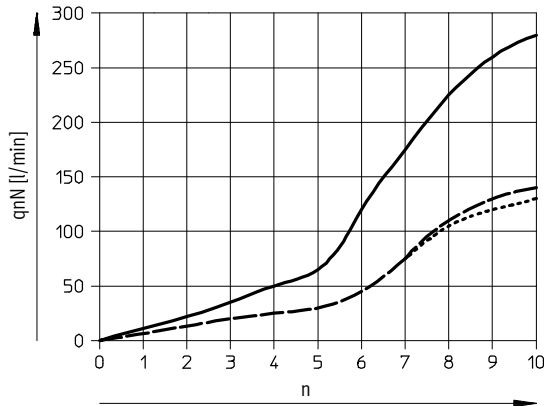

— GRXA-HG-1/4-QS-8,
GRXA-HG-1/4-QS-6
- - GRXA-HG-1/8-QS-6
- · - GRXA-HG-1/8-QS-4

Standard flow rate q_n at 6 \rightarrow 0 bar
as a function of turns of the adjusting screw n

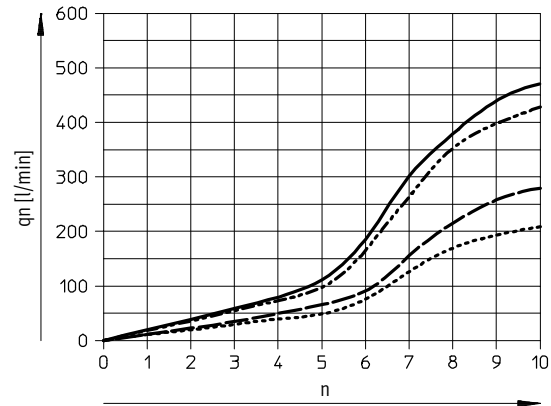

— GRXA-HG-1/4-QS-8
- - GRXA-HG-1/4-QS-6
- · - GRXA-HG-1/8-QS-6
- · - GRXA-HG-1/8-QS-4

Minimum pilot pressure p_{21} as a function of operating pressure p_1

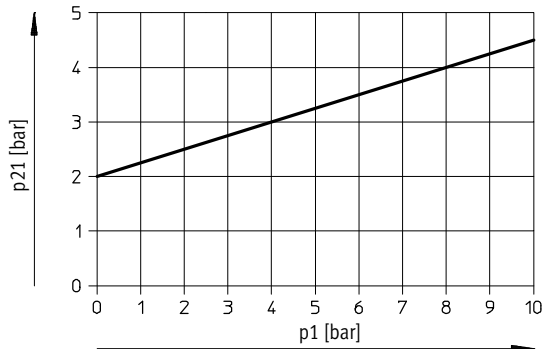

Materials

Sectional view

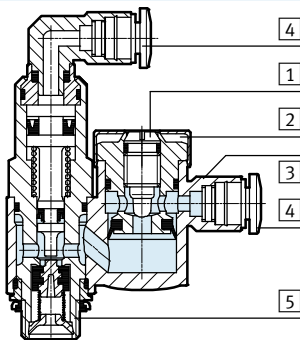

One-way flow control valve		
1	Adjusting screw	Brass
2	Cap	Anodised wrought aluminium alloy
3	Swivel connection	POM
4	Releasing ring	POM
5	Hollow bolt	Anodised wrought aluminium alloy
-	Seals	NBR
Note on materials		RoHS-compliant

- 1 - Type discontinued
Available up until 2019

One-way flow control valves GRXA, function combination

Technical data – Push-in connector QS, metal

FESTO

Dimensions

Download CAD data → www.festo.com

Slotted head screw

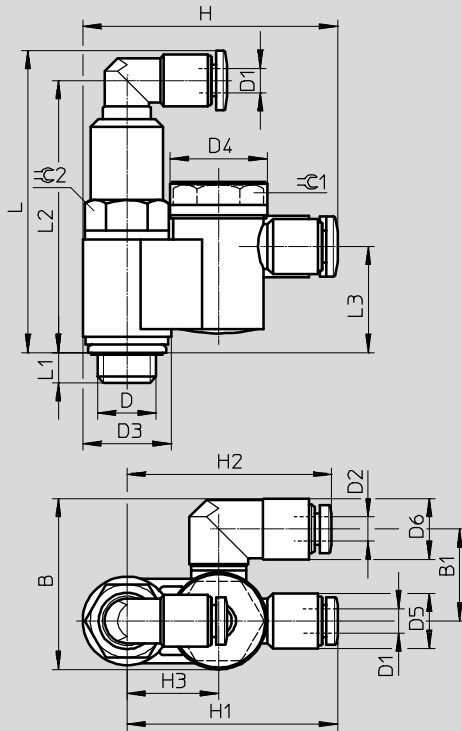

Type	Connection D	Tubing O.D.		B	B1	D3 ∅	D4 ∅	D5 ∅	D6 ∅	H	H1	H2	H3	L	L1	L2	L3	≈C 1	≈C 2
		D1	D2																
GRXA-HG-1/8	G1/8	4	4	28	15	14.5	15.9	9	10	41.8	34.5	33.5	15	49.5	4.9	44.6	17.4	13	12
		4	6	31.5	17.3				12.5	41.8		34.5							
GRXA-HG-1/4	G1/4	4	6	36.1	19.5	19	20.6	9	12.5	52.2	42.7	40.5	21	56.3	5.6	51.4	21.1	17	16
		4	8	40.3	21.5				17	58.2		48.7							

Ordering data – Exhaust air one-way flow control function

	Pneumatic connection		Standard nominal flow rate qnN at 6 → 5 bar		Standard flow rate qn at 6 → 0 bar		Weight [g]	Part No.	Type
			in direction of flow control	in non-return direction	in direction of flow control	in non-return direction			
	2	1	[l/min]	[l/min]	[l/min]	[l/min]			
	G1/8	QS-4	130	100 ... 140 100 ... 140 ¹⁾	210	220 ... 250 230 ... 260 ¹⁾	28.2	525667	GRXA-HG-1/8-QS-4
			140	120 ... 160 115 ... 165 ¹⁾	280	260 ... 300 270 ... 300 ¹⁾	28.2	525668	GRXA-HG-1/8-QS-6
	G1/4	QS-6	280	180 ... 260 200 ... 270 ¹⁾	430	410 ... 470 430 ... 490 ¹⁾	58.8	525669	GRXA-HG-1/4-QS-6
			280	190 ... 260 200 ... 280 ¹⁾	470	440 ... 500 460 ... 520 ¹⁾	58.8	525670	GRXA-HG-1/4-QS-8

1) Unactuated