

Features and Benefits

- The control circuit and the LED share the only power source.
- Control circuit and RGB chip are integrated in a package of 5050 components, to form a complete addressable pixel.
- Built-in signal reshaping circuit, after wave reshaping to the next driver, ensure wave-form distortion not accumulate.
- Built-in electric reset circuit and power lost reset circuit.
- Each pixel of the three primary color can achieve 256 brightness display, completed 16777216 color full color display, and scan frequency is of 2KHz.
- Cascading port transmission signal by single line.
- Any two point the distance not more than 3m transmission signal without any increase circuit.
- When the refresh rate is 30fps, cascade number are not less than 1024 pixels.
- Send data at speeds of 800Kbps.
- The color of the light is highly consistent, cost-effective..

Applications

- Full-color module, Full color soft lights a lamp strip.
- LED decorative lighting, Indoor/outdoor LED video irregular screen.

General description

WS2812B is a intelligent control LED light source that the control circuit and RGB chip are integrated in a package of 5050 components. It internal include intelligent digital port data latch and signal reshaping amplification drive circuit. Also include a precision internal oscillator and a 12V voltage programmable constant current control part, effectively ensuring the pixel point light color height consistent.

The data transfer protocol use single NZR communication mode. After the pixel power-on reset, the DIN port receive data from controller, the first pixel collect initial 24bit data then sent to the internal data latch, the other data which reshaping by the internal signal reshaping amplification circuit sent to the next cascade pixel through the DO port. After transmission for each pixel, the signal to reduce 24bit. pixel adopt auto reshaping transmit technology, making the pixel cascade number is not limited the signal transmission, only depend on the speed of signal transmission.

RESET time > 280 μ s , it won't cause wrong reset while interruption, it supports the lower frequency and inexpensive MCU.

Refresh Frequency updates to 2KHz, Low Frame Frequency and No Flicker appear in HD Video Camera, it improve excellent display effect.

LED with low driving voltage, environmental protection and energy saving, high brightness, scattering angle is large, good consistency, low power, long life and other advantages. The control chip integrated in LED above becoming more simple circuit, small volume, convenient installation.

Mechanical Dimensions

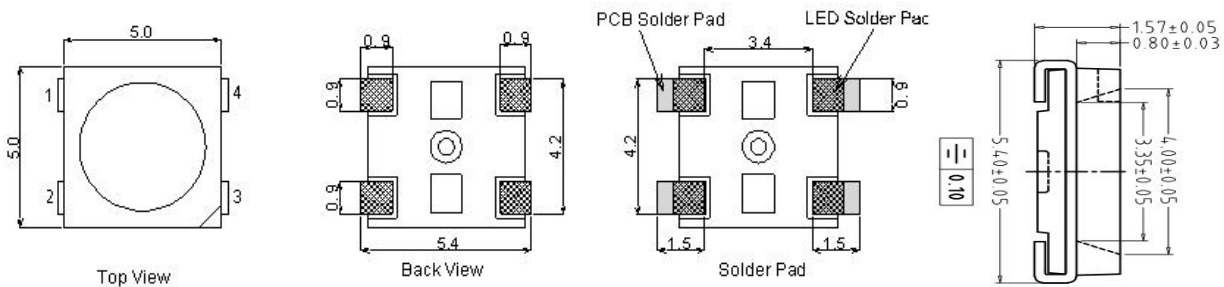

Remarks: Dimension of 5.0*5.4*1.57mm, default Tolerance of 0.05mm.

PIN Configuration

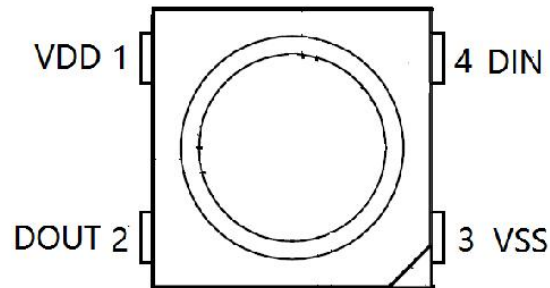

PIN Function

NO.	Symbol	Function description
1	VDD	Power supply LED
2	DOUT	Control data signal output
3	VSS	Ground
4	DIN	Control data signal input

Absolute Maximum Ratings

Parameter	Symbol	Ratings	Unit
Power supply voltage	V_{DD}	+3.7~+5.3	V
Logical Input Voltage	V_I	$V_{DD}-0.7 \sim V_{DD}+0.7$	V
Operation junction temperature	T_{opt}	-25~+85	°C
Storage temperature range	T_{stg}	-40~+105	°C

Electrical Characteristics ($T_A=-20\sim+70^{\circ}\text{C}$, $V_{DD}=4.5\sim 5.5\text{V}$, $V_{SS}=0\text{V}$, unless otherwise specified)

Parameter	Symbol	Min	Tpy	Max	Unit	Conditions
Input current	I_I	—	—	± 1	μA	$V_I=V_{DD}/V_{SS}$
Input voltage level	V_{IH}	$0.7V_{DD}$	—	—	V	D_{IN}, SET
	V_{IL}	—	—	$0.3 V_{DD}$	V	D_{IN}, SET
Hysteresis voltage	V_H	—	0.35	—	V	D_{IN}, SET

Switching Characteristics ($T_A=-20\sim+70^{\circ}\text{C}$, $V_{DD}=4.5\sim 5.5\text{V}$, $V_{SS}=0\text{V}$, unless otherwise specified)

Parameter	Symbol	Min	Tpy	Max	Unit	Condition
Transmission delay time	T_{PLZ}	—	—	300	ns	$CL=15\text{pF}$, $D_{IN}\rightarrow D_{OUT}$, $RL=10\text{K}\Omega$
Fall time	T_{THZ}	—	—	120	μs	$CL=300\text{pF}$, $OUTR/OUTG/OUTB$
Input capacity	C_I	—	—	15	pF	—

LED Characteristics

Parameter	Symbol	Color	Quiescent Current: 0.5mA			Unit	Condition (Working current)
			Mini	Typ	Max		
Brightness	IV	Red	150	--	200	mcd	5mA
		Green	400	--	600		
		Blue	100	--	150		
Wavelength	λ_d	Red	620	--	630	nm	5mA
		Green	515	--	525		
		Blue	465	--	475		

Data Transfer Time

T0H	0 code, high voltage time	220ns~380ns
T1H	1 code, high voltage time	580ns~1 μs
T0L	0 code, low voltage time	580ns~1 μs
T1L	1 code, low voltage time	220ns~420ns
RES	Frame unit, low voltage time	>280 μs

Sequence Chart

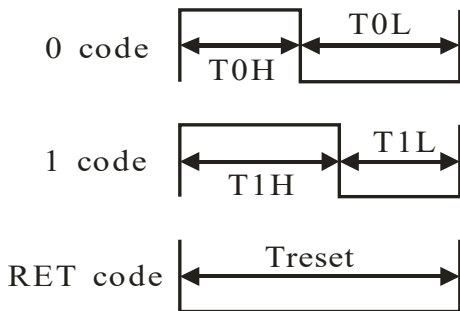

Cascade Method

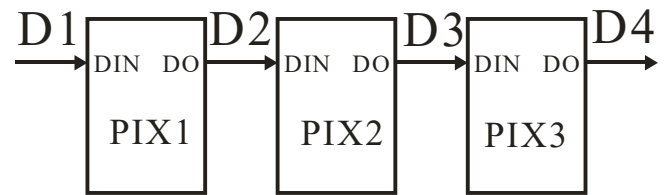

Data Transmission Method

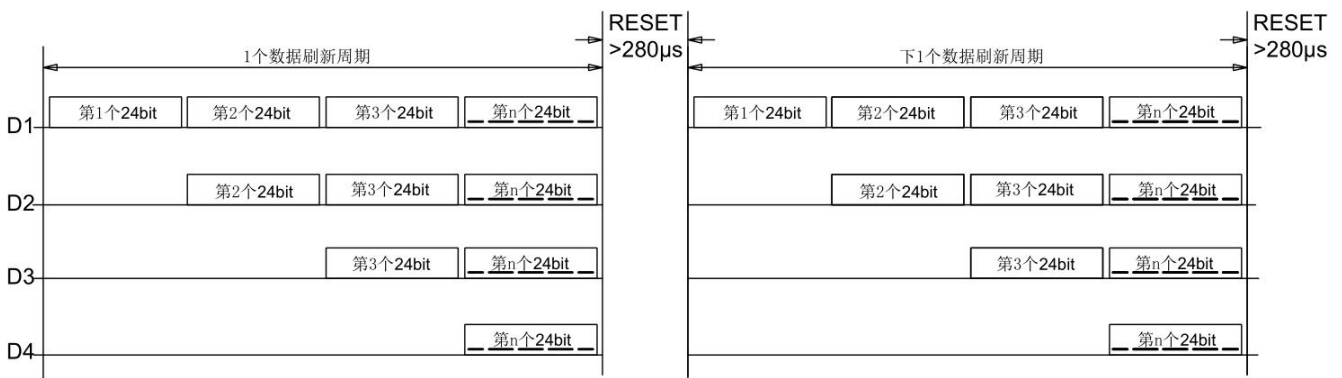

Note: The data of D1 is send by MCU, and D2, D3, D4 through pixel internal reshaping amplification to transmit.

Composition of 24bit Data

G7	G6	G5	G4	G3	G2	G1	G0	R7	R6	R5	R4	R3	R2	R1	R0	B7	B6	B5	B4	B3	B2	B1	B0
----	----	----	----	----	----	----	----	----	----	----	----	----	----	----	----	----	----	----	----	----	----	----	----

Note: Data transmit in order of GRB, high bit data at first.

Typical Application Circuit

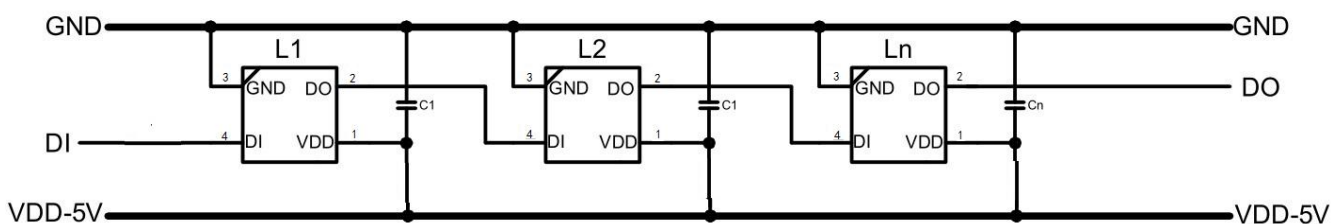

Remarks: C1 is the filter capacitor for VDD, its value of 100NF.

Packing Standard

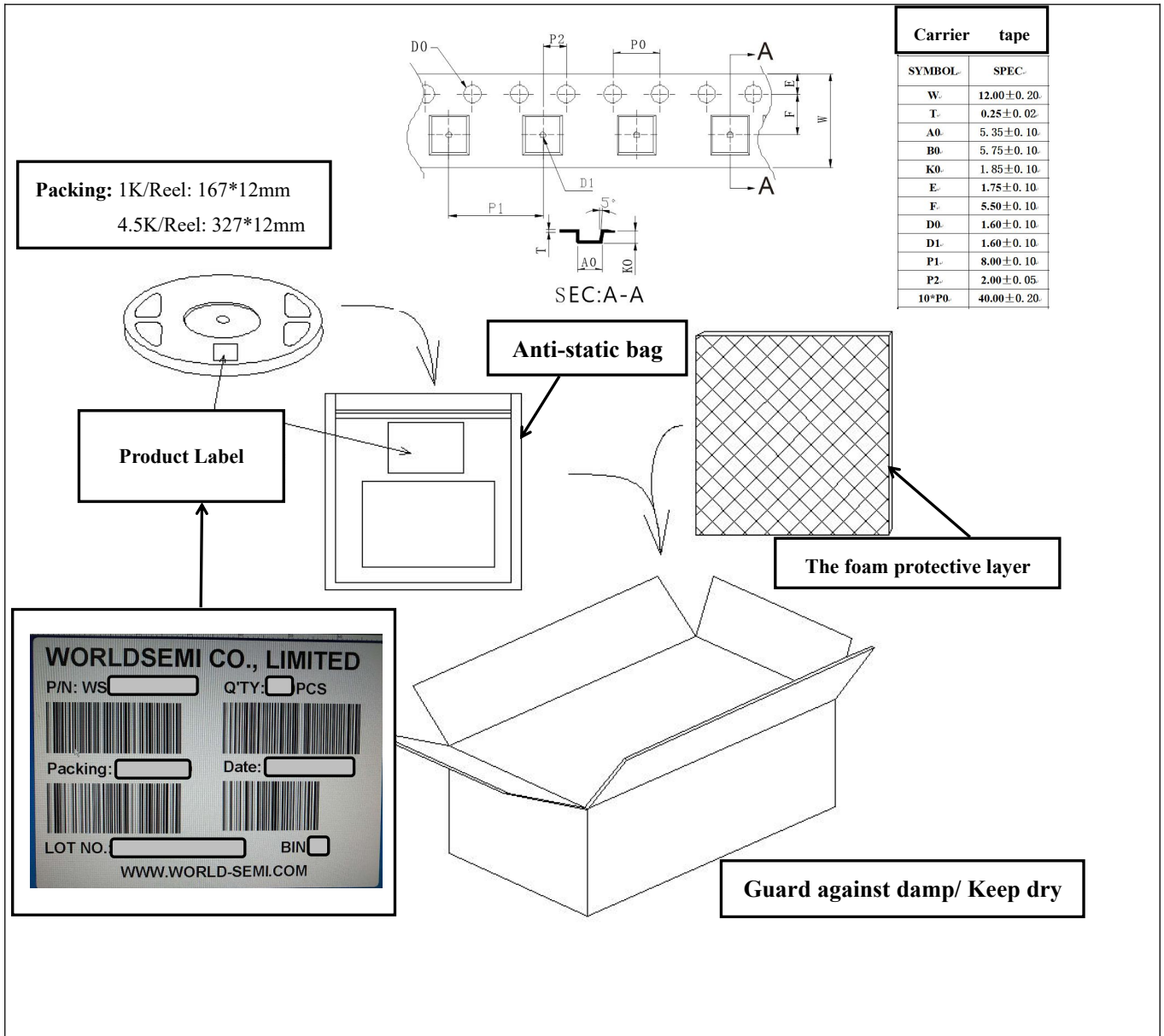

Top SMD LED Using Instructions

1. Summary

To make the best use of WORLDSEMI's LED, please refer to the below precautions, they are of same usage method as other electronic components.

2. Cautions

2.1. Dust & Cleaning

The surface of the LED is encapsulated with modified epoxy resin because it plays a very good role in protecting the optical performance and aging resistance. The modified epoxy resin is easy to stick with dust and must be kept clean. When there's a certain amount of dust on the surface of the LED, it won't affect brightness, but dust proof should be taken care of. Promoting the use of unsealed package in preference to others and the assembled LEDs should be placed in a clean container.

Avoid using the organic solvents to clean the dust on the LED surface and it's necessary to confirm whether the cleaning fluid will dissolve the LED.

Do not clean the LEDs by the ultrasonic. Some parameters affecting the LED performance must be evaluated if have no alternative but to the ultrasonic cleaning method, such as ultrasonic power, baking time and assembly conditions, etc.

2.2. Moisture-proof packaging

TOP SMD LEDs are moisture sensitive components. LEDs are packaged in aluminum foil bag to prevent the from absorbing moisture during transport and storage. A desiccant is placed in the bags to absorb moisture. If the LED absorbs moisture, then it evaporates and expands when in reflow process, which may break the colloid from the bracket and damage the optical performance of LED. For this reason, moisture-proof packaging is to prevent the from absorbing moisture during transport and storage. The moisture resistance rating of WORLDSEMI's LED is: **LEVEL 6.**

Table I - IPC/JEDEC J-STD-020 Moisture/Reflow Sensitivity Classification

MSL Level	Workshop Life	
	Time	Conditions
LEVEL1	Unlimited	≤30°C/85%RH
LEVEL2	1 Year	≤30°C/60%RH
LEVEL2a	4 Weeks	≤30°C/60%RH
LEVEL3	168 Hours	≤30°C/60%RH
LEVEL4	72 Hours	≤30°C/60%RH
LEVEL5	48 Hours	≤30°C/60%RH
LEVEL5a	24 Hours	≤30°C/60%RH
LEVEL6	Take-out and Use immediately	≤30°C/60%RH

2.3. Management after unpacking

It's recommend to perform SMT assembly as soon as possible after opening the moisture-proof bag, and reflow soldering should be completed within 4 hours after SMT assembly; for the remaining LEDs, they should be re-packed in seal package and placed in moisture-proof cabinet (Please note that it's necessary to rebake at "70°C-75°C/48 hours" before next SMT process).

3. Dehumidification Operation (Non-leakage of air, baking temperature:70°C-75°C)

- a. MD within 2 weeks, baking time: 24 hours.
- b. MD exceeds 2 weeks, baking time: 48 hours.

4. Management of secondary SMT process

It's necessary to do moisture-proof treatment when the secondary reflow carried out that followed the first reflow. It can't be more than 2 hours to be exposed at condition of “<30°C/60%RH” and dehumidification operation is requested for a longer interval reflow. For instance, place in a drying box or a container with desiccant, and dehumidify it before the secondary reflow(Low temperature baking operation: **70°C-75°C, ≥12 hours**).

5. SMT Reflow

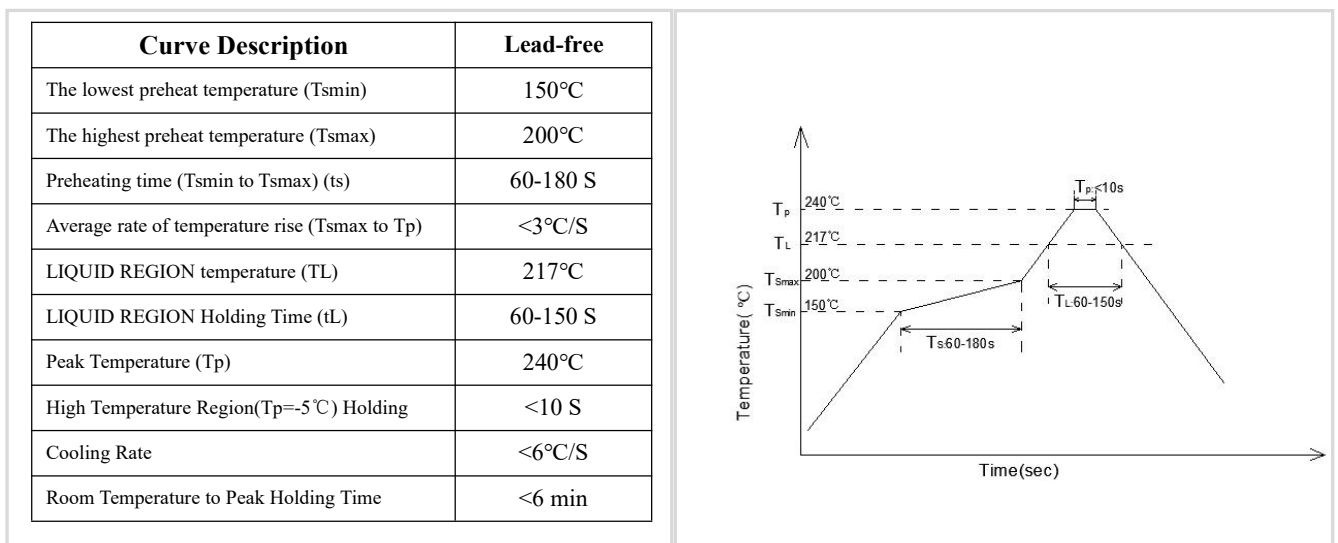

Refer to the parameters listed below, the experimental results prove that the TOP SMD LED meets the JEDEC J-STD-020C standards. As a general guideline, it is recommended to follow the SMT reflow temperature curve recommended by the solder paste manufacturer.



Remarks: 1. These general guidelines may not apply to all PCB designs and reflow soldering configurations.

- 2. All temperatures referred are measured on the surface of the package body.

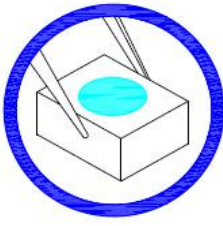
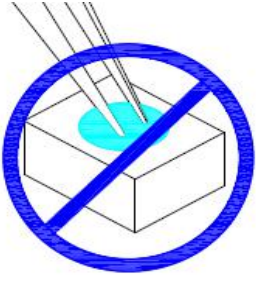
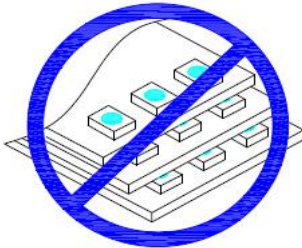
6. Assembly Precautions

<p>1. Clip the LED from its side.</p>	<p>2. Neither directly touch the gel surface with the hand or sharp instrument, it may damage its internal circuit.</p>
	
<p>3. Not to be double stacked, it may damage its internal circuit.</p>	<p>4. Can not be stored in or applied in the acidic sites of PH<7.</p>
	

Modify Record

Version №	Status Bar	Modify Content Summary	Date	Reviser	Approved
V1.0	N	New	20170523	Shen JinGuo	Yin HuaPing
V1.1	M	Absolute Maximum Ratings、 Mechanical Dimensions	20171009	Shen JinGuo	Yin HuaPing
V1.2	M	Maximum ratings, Timing	20180207	Shen JinGuo	Yin HuaPing
V1.3	M	“The transparent sealing silica gel” changed to “The opaque Modified Epoxy Resin”. Refers to PRECAUTIONS	20180412	Shen JinGuo	Yin HuaPing
V1.4	M	Logical Input Voltage; Brightness adjustment; Precautions	20180719	Shen JinGuo	Yin HuaPing

Remarks: Initial version: V1.0; Version number plus "0.1" after each revision;

Status bar: N--New, A--Add, M--Modify, D--Delete.