

JR Series

High Power Jumper Chip

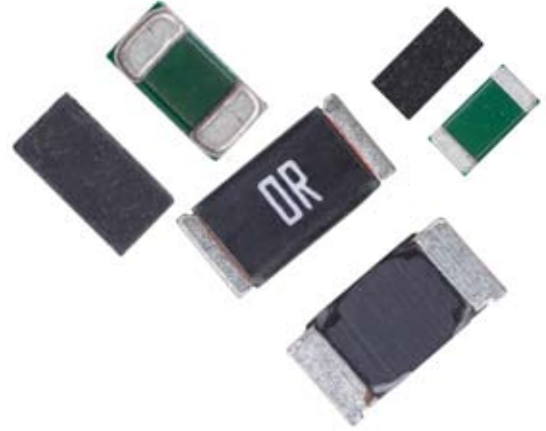

The Ohmite JR series high current jumpers are rated up to 100 amps and provides a max resistance range of 0.5m to 0.2m ohms. This minimizes effects on the designed circuit. Five industry sizes are available. The JR series also provides great insulation resistance over 100M ohms.

SERIES SPECIFICATIONS

Series	Max. Res. (mΩ)	Max. Current (A)	Loading**
JR0402X20E	0.5	20	0.2W
JR0603X26E	0.2	26	0.135W
JR0805X35E	0.2	35	0.245W
JR1206X40E	0.2	40	0.32W
JR2512X100E	≤0.2	100	2W

**based on specific pad layout specific current

FEATURES

- Five standard sizes - 0402 through 2512
- Max resistance below 0.2m ohms
- Max current handling of 100 amps
- Max derating temperature of 170°C (2512)

CHARACTERISTICS

Insulation res.	100MΩ
Rated amb. temp.	70°C
Oper. temp. range	-55°C~150°C; 2512: -55 +170°C
Jumper material	Cu
Storage	Temperature : 25±5°C Humidity : 60±20% Airtight in temp. 10°C~40°C, relative humidity 75% can store 2 years. Without dew in temp. 10°C~60°C, relative humidity 95% max. value for 30 days.

Construction

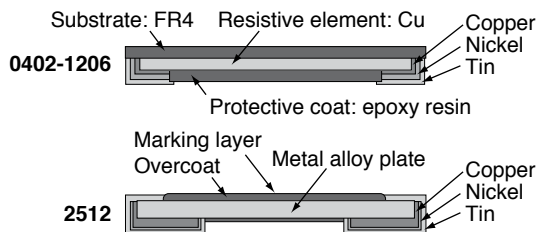

Derating

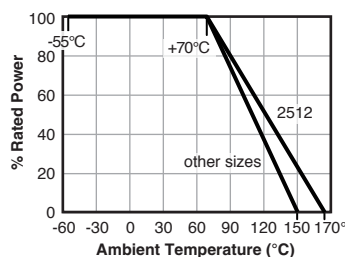

PERFORMANCE

0402, 0603, 0805, 1206

Test	Procedure	Requirement
High Temp. Exposure	T = +150 ±2°C; t = 1000h; IEC60115-1 4.25	<Rmax
Low Temp. Storage	T = -55±2°C; t = 1000h; IEC60115-1 4.25	<Rmax
Moisture Load Life	(60°C, 95%RH) Vtest = Vmax; T=60±2°C; RH=95%; t= 90min ON, 30min OFF, 1000h; IEC60115-1 4.25	<Rmax
Thermal Shock	-55°C 30min.; R.T. 3min.; +150°C 30min.; R.T. 3min); 100Cycles; IEC60115-1 4.19	<Rmax
Load Life at 70°C	Vtest = Vmax; T=70 ±2°C; t= 90min ON, 30min OFF, 1000h; IEC60115-1 4.25	<Rmax
Solderability	Dip into solder at T = 245±5°C, t = 3 ±0.5 sec.; IEC60115-1 4.17	95% coverage
Resistance to Solder Heat	Through Reflow; T= 275 ±5°C, t =20 ±1sec.; IEC60115-1 4.18	<Rmax

2512

Test	Procedure	Requirement
Short time over-load	4x rated power, 5 sec.; JIS C 5201-1 4.13	≤0.2mΩ
Temp. cycling	-55°C to 150°C, 1000 cy., 15 min. at each extreme; JIS C 5201-1 4.23.2	≤0.2mΩ
High Temp. Exposure	1000 hrs. at 170°C	≤0.2mΩ
Bias humidity	1000 hrs. at 85°C/85%RH, 10% bias 1.5 hrs. on, 0.5 hrs. off; JIS C 5201-1 4.24	≤0.2mΩ
Load at rated power	1000 hrs. at 70°C, 1.5 hrs. on, 0.5 hrs. off; JIS C 5201-1 4.25	≤0.2mΩ
Solderability	245 ±5°C, 2 ±0.5 sec.; JIS C 5201-1 4.17	95% coverage

(continued)

JR Series

High Power Jumper Chip

SOLDERING

Wave Soldering

Preheating : 100~130°C, max.100 sec.
Soldering: 250~265°C max. 10 sec.
Max. temp.: 260 ±5°C, max. 10 sec.

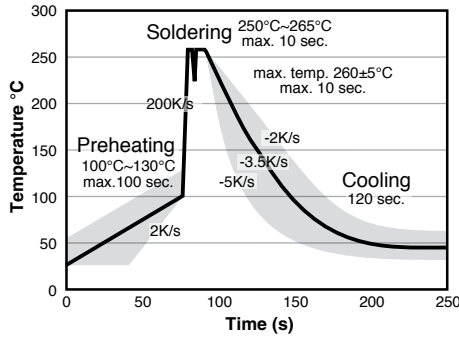

Reflow Soldering

Preheating: 145 ±15°C, max.120 sec.
Soldering: min. 220°C, max. 60 sec.
Max. temp.: 260±5°C, max. 10sec.

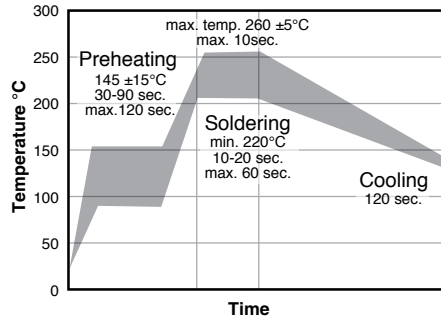

Rework temperature: (hot air equipment) 350°C, 3~5 seconds

Recommended reflow methods: IR, vapor phase oven, hot air oven. If reflow temperatures exceed the recommended profile, devices may not meet the performance requirements.

Reflow Soldering: 2512 Size

Preheating: 150°~180°C, max.120 sec.
Soldering: min. 230°C, max. 40 sec.
Max. temp.: 250±5°C, max. 10sec.

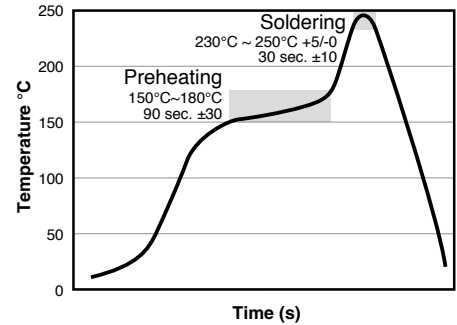

DIMENSIONS

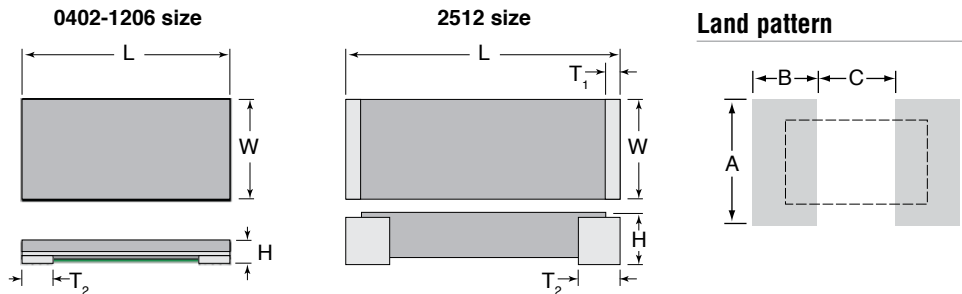

Type	W	L	H	T1	T2	A	B	C
JR0402X20E	0.50 ±.20	1.00 ±.20	0.35 ±.20	-	0.20 ±.15	0.60	0.60	0.40
JR0603X26E	0.80 ±.20	1.60 ±.20	0.35 ±.20	-	0.35 ±.20	0.92	1.30	0.60
JR0805X35E	1.25 ±.20	2.00 ±.20	0.35 ±.20	-	0.35 ±.20	1.44	1.40	0.80
JR1206X40E	1.60 ±.20	3.20 ±.20	0.50 ±.20	-	0.50 ±.20	1.84	1.80	1.20
JR2512X100E	3.05 ±.25	6.35 ±.25	0.67 ±.25	0 ~ 0.20	1.10 ±.25	3.68	2.11	3.18

(continued)

JR Series

High Power Jumper Chip

TAPE AND REEL

(mm)

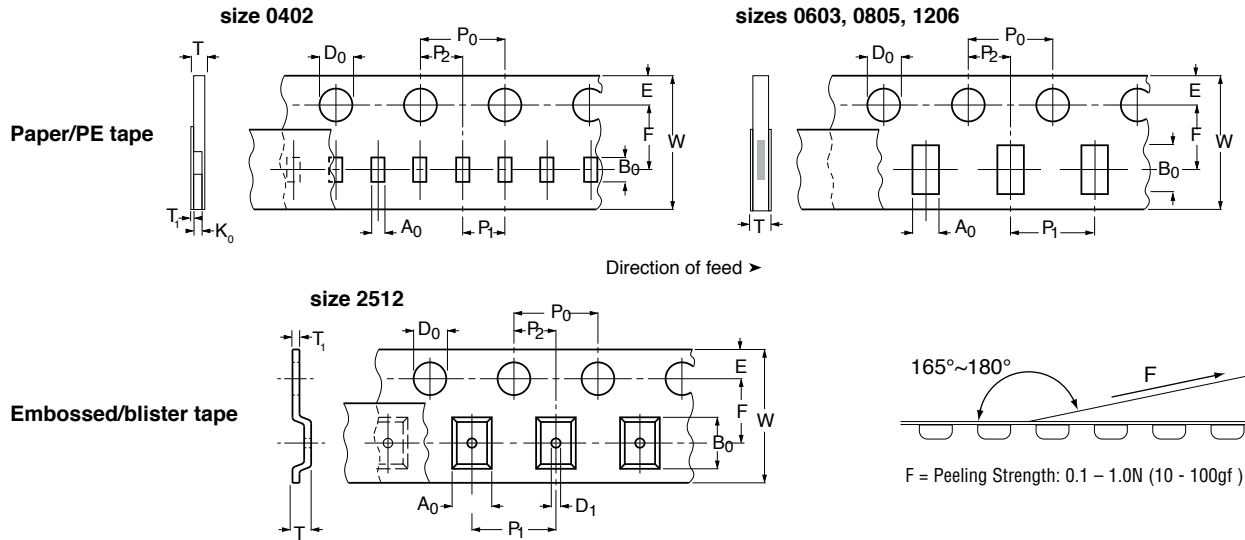

Size	W	P0	P	P2	A0	B0	D0	D1	F	E	T	T1	K0
0402	8.00 ±.30	4.00 ±.10	2.00 ±.10	2.00 ±.10	0.75 ±.20	1.25 ±.20	1.50 ±.10	-	3.50 ±.10	1.75 ±.10	0.50 ±.05	Max. 0.1	0.40 ±.05
0603	8.00 ±.30	4.00 ±.10	4.00 ±.10	2.00 ±.10	1.18 ±.20	1.98 ±.20	1.50 ±.10	-	3.50 ±.10	1.75 ±.10	0.58 ±.10	-	-
0805	8.00 ±.30	4.00 ±.10	4.00 ±.10	2.00 ±.10	1.55 ±.20	2.30 ±.20	1.50 ±.10	-	3.50 ±.10	1.75 ±.10	0.58 ±.20	-	-
1206	8.00 ±.30	4.00 ±.10	4.00 ±.10	2.00 ±.10	2.05 ±.20	3.65 ±.20	1.50 ±.10	-	3.50 ±.10	1.75 ±.10	0.75 ±.20	-	-
2512	12.0 ±.30	4.00 ±.10	4.00 ±.10	2.00 ±.10	3.50 ±.10	6.75 ±.10	1.50 +1/-0	1.55 ±.10	5.5 ±.10	17.5 ±.10	0.90 ±.10	0.20 ±.05	-

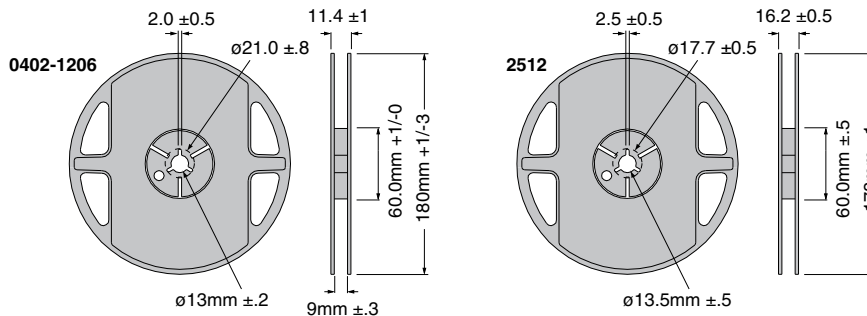

Size	qty/reel	weight (g)
0402	10,000	100 ±.30
0603	5,000	140 ±.30
0805	5,000	160 ±.30
1206	5,000	180 ±.30
2512	4,000	-

ORDERING INFORMATION

J R 0 6 0 3 X 2 6 E

Series Size Modifier Current Rating RoHS Compliant

Part No.	Max. Res. (mΩ)	Max. Current (A)
JR0402X20E	0.5	20
JR0603X26E	0.2	26
JR0805X35E	0.2	35
JR1206X40E	0.2	40
JR2512X100E	≤0.2	100