



WWW.LINDSTROMTOOLS.COM

Lindstrom Precision Tools invites you to visit our new web site. Our latest up to date information is now available to you either on screen or via download. Enjoy our always available comprehensive web site featuring the best in assembly, rework and repair tools.



Web site includes:

- Lindstrom's complete range of products.
- Ergonomics.
- Trade show & product exhibition.
- New products.
- Literature availability (Catalogs, Brochures and Flyers).
- Quick link to downloadable high resolution product photographs.
- Where to find Lindstrom Distributors in your area.
- How to contact a local Lindstrom Manufacturing Representative.
- And much more.

Log on today and discover Lindstrom Precision Tools. We stand ready to solve your assembly, rework and repair needs.

LINDSTROM[®]
P R E C I S I O N T O O L S

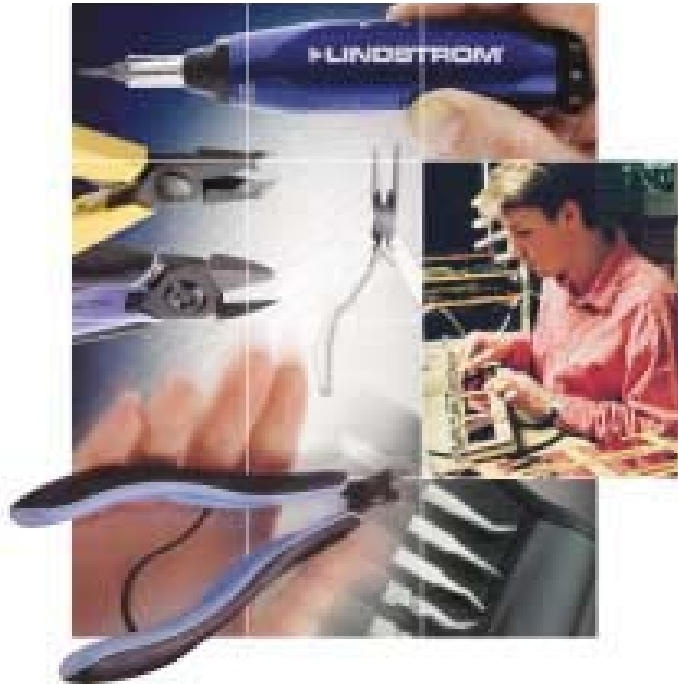

Lindstrom Precision Tools Catalog 2

ML-9013-UK

Graphic Design • Newton Communications AB • Printed in Sweden

Enköping • May 2002

NEW

HS6000 MULTI-PURPOSE SHEAR

The HS6000 is a shear action multi-purpose cutter primarily designed to cut through Kevlar elements used in fiber optic and other types of cables. See pages 31 and 60 for more information.



RX MICRO TIP CUTTERS

The Rx Micro Tip cutter is ideal for cutting extremely fine wires and leads, in many types of applications. Available in both straight and angled tip versions. See pages 44, 45 and 46 for more information.



STUBBY SCREWDRIVERS AND SETS

Stubby screwdrivers allow users to access restrictive areas with ease and retain all the excellent ergonomic properties of the full range of screwdrivers offered by Lindstrom. See pages 34, 35, 91, 93 and 94 for more information on our Stubby range and our expanded selection of screwdriver sets.



NEW

TORQUE SCREWDRIVERS

Lindstrom's new line of torque screwdrivers combine user friendliness with a high degree of precision. Available in microadjustable and preset torque versions. See pages 33 and 88 for more information.



TWEezer WALLET SETS FOR PRECISION WORK

Tweezer wallets are available for a broad range of precision applications, including SMD and handling of ESD-sensitive components. See pages 85 to 87 for detailed information.



TOOL CASE 9850, 9851

A high quality service case containing a variety of tools such as cutters and pliers, screwdrivers, tweezers, files, soldering iron, pick & place tools, adjustable wrench and much more supplied in a aluminium/plastic case. See page 101 for more information.

TOOL KITS 9841, 9846, 9848, 9852

A range of high quality service kits containing a variety of tools such as cutters and pliers, screwdrivers, tweezers, adjustable wrenches and more, supplied in a zipper wallet. See pages 100 and 101 for more information.



LINDSTROM PRECISION TOOLS

The expression “the right tool for the job” could not be more appropriate than in a discussion about handtools. Whether in the hands of a skilled professional or a new operator, the right tool can make the most difficult operation a simple task.

Lindstrom Precision Tools is your source for the right handtool for electronic, electromechanical and medical device assembly, rework and repair.

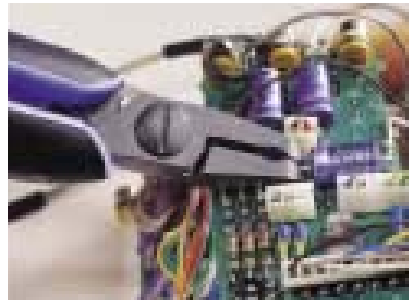



Contents

HANDTOOL APPLICATIONS AND TECHNOLOGY

Cutters	7
Pliers	18
Tweezers	21
Design	23

PRODUCT RANGES

Rx Cutters and Pliers	26
80-Series Cutters	29
Supreme Cutters and Pliers	30
Multi-Purpose Shear	31
Tweezers	32
Torque Screwdrivers	33
Ergo Screwdrivers	34
Special Engineered Tools	36

INDIVIDUAL LISTINGS AND SPECIFICATIONS

How To Choose	37
Capacity and Options	40
Rx Cutters and Pliers	42
80-Series Cutters	50
Supreme Cutters and Pliers	54
Multi-Purpose Shear	60
Tweezers	61
Tweezers Sets	85
Torque Screwdrivers	88
Torque Screwdrivers Sets	89
Screwdrivers	90
Screwdrivers Sets	98
Tool Kits	100
Spare Parts	102

REFERENCE

Warranty	103
Index by Type	104
Index by Alphanumeric Sequence	107
Conversion Tables	109
Capacity and Options	111

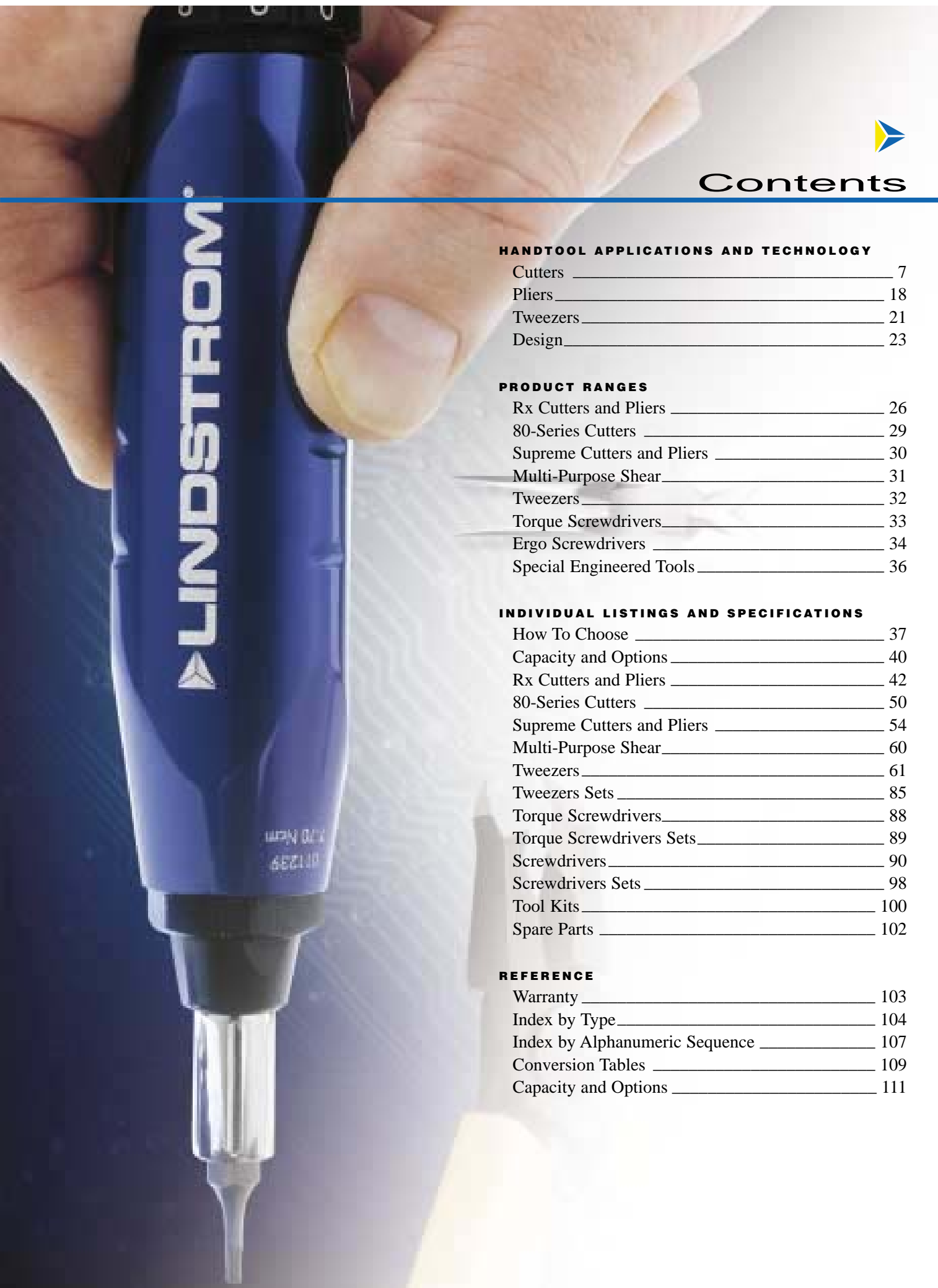

CHOOSING THE RIGHT HANDTOOL

In today's complex assembly environment, it is important to understand and consider the different requirements and conditions that affect your choice of handtools.

For example:

- **How frequently are you going to use the tool?**
- **What type of result are you trying to achieve?**
- **What kind of material are you going to cut or bend?**
- **Can you use one tool instead of two?**
- **Do you have concerns about ESD or other specialized standards?**

These questions and many more should be considered in making your choice. We have included additional information to assist you in choosing the right tool for your application.





Cutters

LINDSTROM HISTORY

Started in 1856, Lindstrom has set the standard in precision tool manufacturing. The oldest continuous producer of handtools in existence today, Lindstrom maintains its edge over the competition through its technical understanding, response to market needs, and commitment to advanced technology. Metallurgy, manufacturing techniques, and tremendously skilled crafts people (particularly in the hardening of steel) are the hallmarks of this world renowned Swedish manufacturer.

Some companies have been able to implement one facet or another of the Lindstrom manufacturing cycle. Others have attempted to copy the form, appearance and even the actual part numbers of Lindstrom cutters. However, none has been able to successfully blend all the elements that are required to achieve the level of performance recognized worldwide as belonging to a true Lindstrom cutter.

The Rx8211 combines good application visibility, hand and tool positioning capability and small size with great strength. It is among one of the best angle head tools on the market and a prime example of that which is truly Lindstrom - precision with power. See page 45 for more on Rx8211.

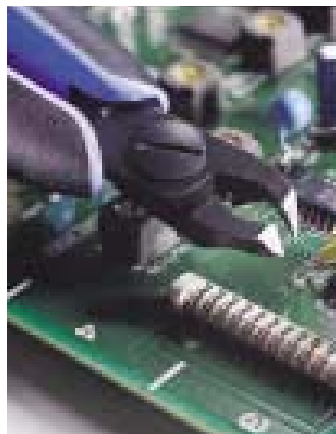

BACKGROUND

Many years ago, cutters were primarily used in heavy-duty work, i.e., cutting heavy electrical wire and wires used in the telecom field. In order to meet the requirements of linemen and other general use

workers, tool manufacturers designed a cutter that left a wide, pyramid-shaped lead end after cutting. Its hardness was adequate for the strain put on the cutter blades. Moreover, the cutters had to be designed with an overall ruggedness: capable of withstanding a drop from a ten-story building without being severely damaged.

However, as the electronics and other related industries developed, the requirements on tools, and in particular cutters, became far different. For example, many people believe that an electrician must do a lot of cutting. Yet, an electrician may make

An electronic assembly operator may make more cuts in one month than an electrician makes in a lifetime.





Cutters

fewer cuts in his lifetime than some electronic assembly workers make in one month! Therefore, the need for cutting small wires thousands and thousands of times necessitated a radically new and innovative technology.



The Rx8140 used in traditional over-hand grip. see page 42 for more on Rx8140.

Small cutters were needed that could cut both extremely small and relatively large diameter wires, often of quite different materials. In addition, the lead ends had to be quite different since the solderability of these wires was of paramount importance. These lead ends had to be covered completely and properly with no bare copper (or basis material) exposed.

Compounding the problem was the accessibility issue, as not all cutters could get into the same area. Transmission of the mechanical shock of cutting to sensitive semiconductors added even more cutter design challenges. However, despite some manufacturers' claims to the contrary, there are no secret or "magic" materials or processes that can give

you some kind of "super" cutter for all applications. Some inherent "trade-offs" in the design of tools and choices must be made in order to meet certain application requirements. For example:

At what point is the cutter head small enough to gain access and still be able to withstand the impact of cutting wires (of various sizes) innumerable times?

How flush should the cutting edges be in order to meet tough specifications yet still keep tool life extended to the maximum? And what about resistance to edge damage due to occasional misuse?

To what degree of hardness should the tool be made in order to extend tool life and still limit breakage due to being too brittle?

What type of joint should be put into a tool to extend the precision of the cutting edges and still be cost effective for you to use?

Understanding these trade-offs is the key to making an objective and cost-effective choice of tools for your specific application.

MATERIALS

Every cutter begins with basic materials. However, materials can vary greatly with just a minute change in the mixture. A slight adjustment to the ingredients can affect how a particular steel reacts, and Lindstrom has been refining this mixture for almost 150 years.

The 1% Carbon, combined with a pinch of chrome and various other materials, is very similar to the steel grade and mixture used for high quality ball bearings. This is the material used for Lindstrom Rx and 80-Series cutters.



Cutters

RESILIENCY

One of the challenges in tool design and usage alike is the search to increase tool life. Decreased life is caused generally by usage beyond the limits of the material and its corresponding hardness.

The use of ball bearing grade steel together with proper heat treatment offers the possibility of a cutter of tremendous resiliency and toughness with the ability to withstand greater impact, yet with the ability to return to its original form without damage. This is one of the reasons why Lindstrom cutters offer greater life and have less breakage than other brands used in the same applications.

LUBRICITY

Another characteristic that emerges from a Lindstrom cutter is the ease with which the tool makes its cut. It is as if there is a built-in lubricant, which makes the cutting easier. This not only helps to make a better cutter, but also reduces operator fatigue.

HARDNESS

Different steels have different personalities – each allowing a certain level of hardness. If a specific steel is hardened too much for its composition, it will break easily. On the other hand, not enough hardening can sharply reduce tool life. How a steel is

cooled (after hardening) and recognizing the different strength capacities of that steel are some of the key factors that make the hardening process a difficult science to master.

Measuring the hardness on a Rockwell Hardness Scale, Lindstrom cutters are elevated to a hardness of 63-65 on the cutting edge, as marked on the “C” scale of the tester. This hardness ranks among the highest of any cutters made. For most manufacturers, this hardness level would create a high breakage rate.

Yet, because of the steel and proper control and consistency of the hardening area, and even when used beyond the rated capacity (as they often are!) Lindstrom cutters have remarkably little breakage.





Cutters

METHODS OF MANUFACTURING

FORGINGS

One of the major breakthroughs in Lindstrom technology is the ability to produce exact, precision forgings. Without that capability, the automated production process cannot be utilized effectively. Therefore, as the first step in the manufacturing cycle, forgings are a key element in the total production process. To maintain interchangeability, every forging must be perfectly precise and compatible to one another.

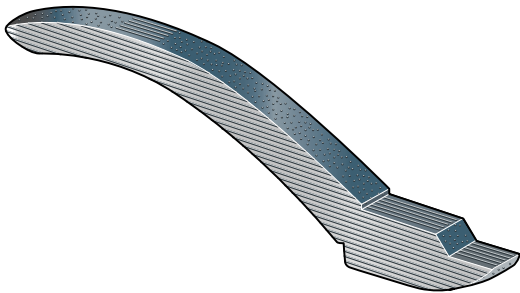

Stamped tools have a straight grain; this construction is useful for certain applications but ultimate tool life and strength can be compromised.

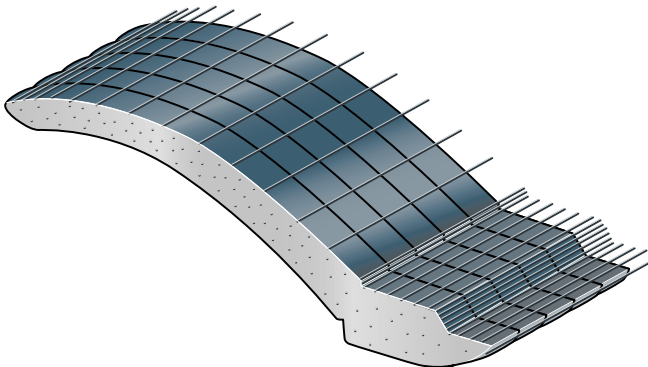

Cutters produced by an extrusion method have a cross grain structure; thus, they are susceptible to greater breakage, particularly along the cutting edges and the joint.

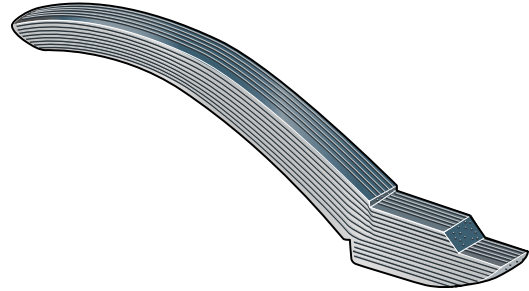

Forged cutters are usually the strongest. Their grain structure follows the profile of the cutter.

Despite automation, any production process can be extremely limiting if not utilized effectively. Lindstrom effectiveness is directly related to the use of forgings of exact dimensions. When forgings are not uniform, it becomes nearly impossible to obtain the repeatability necessary to produce a consistent quality tool. Attempts have been made by others in the industry to automate the manufacturing process without such forgings, but the tools produced are physically erratic. The result is an increased breakage level or rapid deterioration of the cutting edges – expensive tools at any price.



The Rx8247 and even more refined Rx8248 (top), extend the range of applications for angle head cutters. See page 46 and 47 for more on Rx8247 and Rx8248.



Cutters

PROCESSES

Anyone involved in manufacturing knows that to attain a quality process, there are no shortcuts – learning must be by doing. Subsequent steps in the Lindstrom cutter production process have been painstakingly developed over a 30-year period backed by 150 years of precision tool production and know-how. Lindstrom is constantly seeking the best way to achieve consistent quality results. These results are seen in the perfect symmetry of the cutter components, the exactness of the grinding, and the consistent hardening. The reliability and consistency of these details are the Lindstrom hallmark.

CUTTER JOINTS

Of the three primary types of connections commonly used – lap joint with screw, box joint, and lap joint with rivet – each has a distinct value that you should consider in evaluating your choice of cutter.

LAP JOINT WITH RIVET

The lap joint with rivet is both economical and effective for those tools used for occasional work or for heavy-duty cutting where the requirements for precision are not as great. This joint's limitation is that it is difficult to achieve the precision of a screw and nut in terms of holding torque and bearing surface for moving parts and thus it can loosen or develop “play” more easily over time. This leads to misaligned cutting edges, a property that is not conducive to exact and continuous cutting.

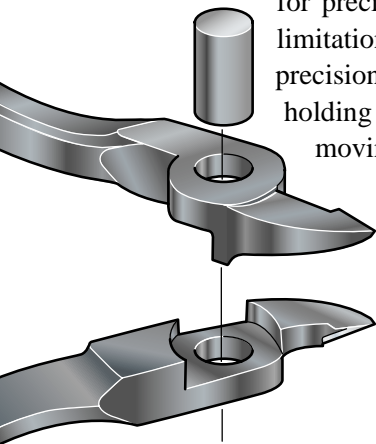

BOX JOINT

The box joint is an older process, developed initially for the jewelry trade where intricate and precise forming of delicate metals is required. The joint is made by sliding one side through the opening of the other side of the joint. Once cooled, the opening closes or is closed, tightening the two sides, which are then linked by a rivet. Most manufacturers typically expand the slot in the head to allow the other half of the tool to be assembled. This offers the possibility of introducing variations on inner contact surfaces in terms of finish and tolerances.

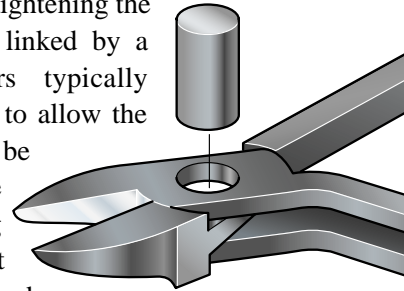

LAP JOINT WITH SCREW

The lap joint with screw is the marriage of a fine pitch threaded screw and miniature nut. It is extremely important that these two parts are geometrically correct. However, there is more to achieving strength and precision in the joint than that. For example, a screw-and-nut combination that is absolutely flush with the edge of the tool may have insufficient threads to maintain consistent alignment. On the other hand, a screw-and-nut combination that has external heads on both sides of the joint may limit the cutter's possibility to be used for a number of tight access applications. Lindstrom eliminated this predicament through the positive integration of both designs. With one flat external head and one flush head, both adverse conditions are eliminated. In the end, this design assures the user of sufficient threads for continuous alignment and a narrower profile for greater accessibility.

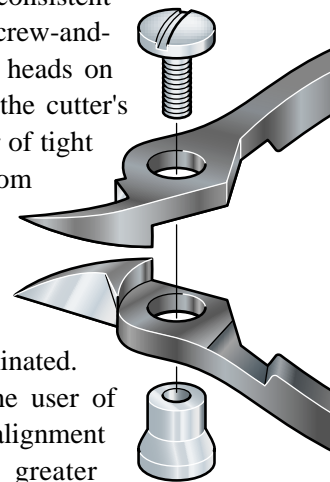



Cutters

CUTTER HEAD SHAPE AND SIZE

Head shapes vary in size and configuration depending on the application. However, there are four primary types, with variations of each.

OVAL HEAD

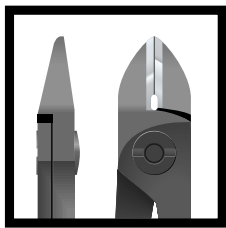

Most common of all the head shapes is the oval head. Combining strength and flexibility, the oval head can withstand and distribute the impact of cutting and is utilized in a myriad of applications.

The head shape combined with materials, method of manufacturing, type of cut, and the tool's hardness, determine the range of cutting capability.



The Rx8130 with miniature oval head will cut copper wire up to 1.25mm/16 gauge in diameter. Yet, the Rx8130 is far smaller than models from other manufacturers considered to be of similar capacity and is one of the strongest miniature cutters on the market. See page 42 for more on Rx8130.

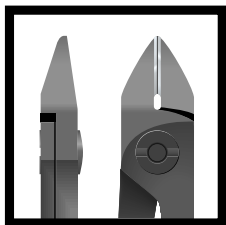

TAPERED HEAD

When the sides of a cutter head are shaped along diagonal lines, the operator can effectively broaden the range of tasks this tool can fulfill.

The Lindstrom tapered head cutter utilizes this design without reducing the cutting range, and increases the number of areas that the operator can gain access to.

However, since the tapered head does not stand up to occasional misuse so well as an oval head design of similar dimensions, a greater degree of care should be observed in its use.

Tapered Rx8143 allows better tip access yet still has a good general range of cutting capacity. See page 43 for more on Rx8143.



Tapered Rx8143 improves cutting access in component removal. See page 43 for more on Rx8143.





Cutters

TAPERED AND RELIEVED HEAD

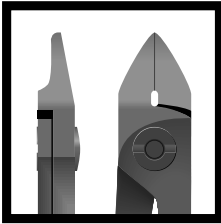

This head style is the smallest of the standard cutting heads available. Not only does it taper on both sides, but also the underside is cut away, allowing the operator to gain access into some difficult areas. Although

this provides an obvious advantage, this head style does have a slightly reduced cutting range.

Special care should be taken not to use tapered and relieved cutters outside their specified range of cutting capability.



Tapered and relieved Rx8146 provides improved access and visibility for even the most difficult job. See page 43 for more on Rx8146.



Tip cutter Rx8149 is an even more specialized adaptation of the tapered and relieved style. Its extreme tapering on all sides allows access and reach. See page 44 for more on Rx8149.



Cutters



Angle head Rx8247 provides benefit of reach and operator visibility. See page 46 for more on Rx8247.



Rx8211 (top) offers outstanding strength and cutting capacity while Rx8247 (bottom) offers better reach. See page 45 for more on Rx8211 and page 46 for more on Rx8247.

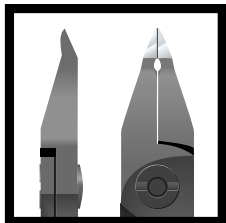

ANGLE HEAD

This head shape is sometimes called an oblique style with its head set at an angle to the main body of the cutter, the purpose of which is to reach between wires or parts or into areas

which are difficult to access. Tools of this design can also be used to trim standard leads or parts – with the advantage being that the operator's hand can be in a different position if desired. The cutting range of the angulated head will vary depending upon its style, but some degree of care should be observed in its use.



The Rx8140 (left) used in traditional over-hand grip. Rx8247 (right) allows an inverted grip in a similar application. See page 42 for more on Rx8140 and page 46 for more on Rx8247.



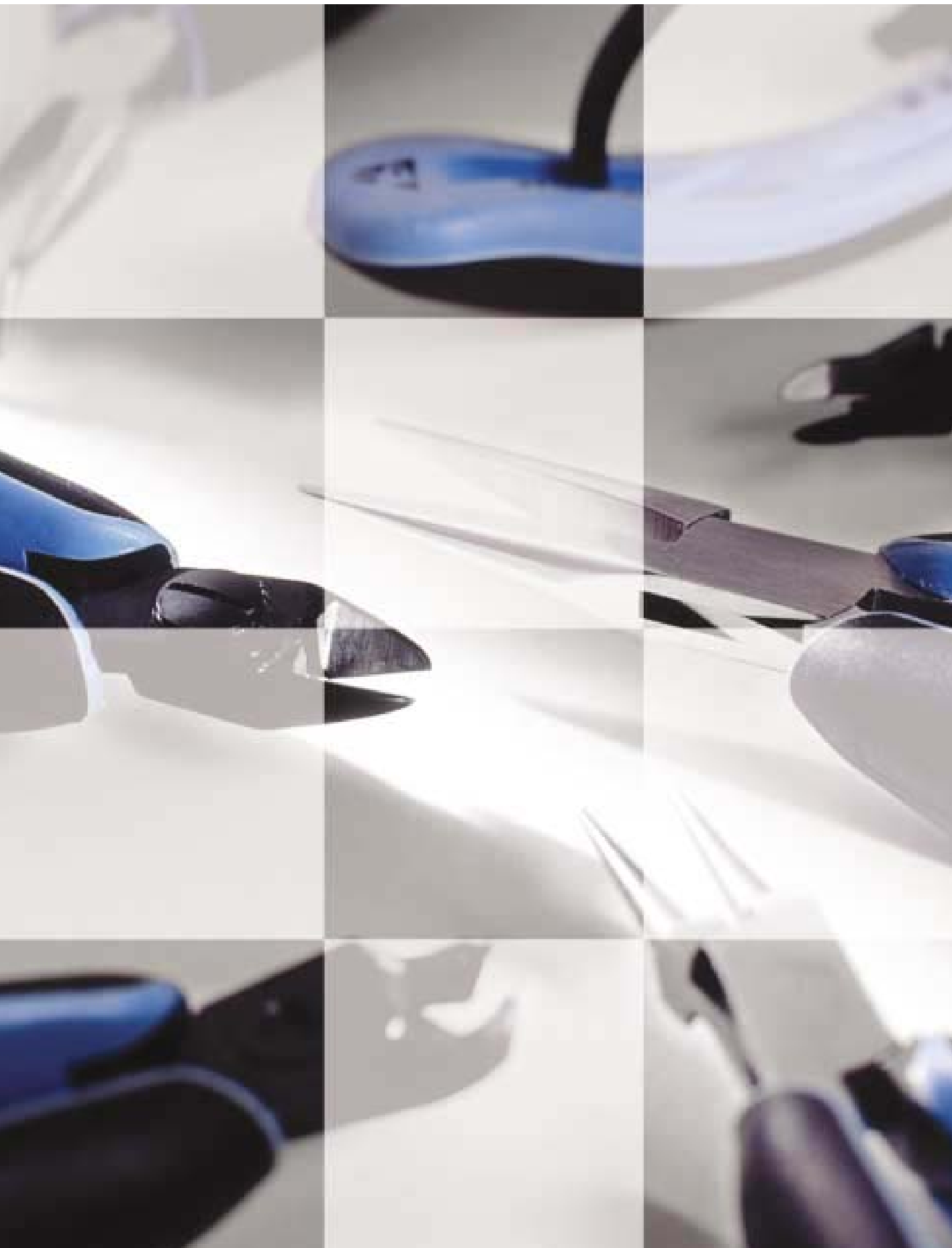



Cutters

CUTTING EDGES

Explaining the type of cut that a particular cutter makes is perhaps the greatest area of confusion and worthy of special study as there is no real standardization of terminology, and each brand offers its own description of its type of cut. Understanding these differences is particularly important in the ordering process.

It is imperative that you recognize what type of cut you require and what the cut lead-end should look like after it is cut. This is especially true in the tighter requirements and specifications of military and high-end commercial electronics.

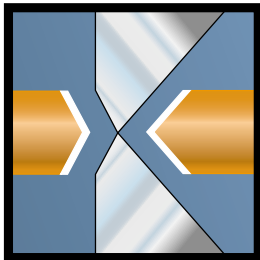

THE SEMI-FLUSH CUT

This type of cut leaves a large lead-end, shaped like a pyramid, and has been manufactured for decades by every tool manufacturer.

This type of cutting edge is a good application match for general electrical or hobby cutting where tool price is often the primary consideration.

This application match is good due to the fact that the cut lead shape is satisfactory for these applications and the cutting edge itself does not require a high level of hardness, sophisticated material to achieve that hardness, or an extremely precise type of joint in order to function.

THE MICRO-BEVEL® CUT

To meet the requirements of the electronic assembly industry, Lindstrom designed the Micro-Bevel. Its unique cut is quite different from the semi-flush cutter. Its leads are “pinched”, unlike the pyramid look of the semi-flush cut, allowing less altitude and smaller overall surface area. Because of its design, it has an extremely wide cutting range, and a variety of uses far beyond any other cutter produced today. For example: Lindstrom produces a cutter (Rx8130) that has a cutting range for copper from 0.2 mm/32 gauge to 1.25 mm/16 gauge yet has a remarkably small overall head size.

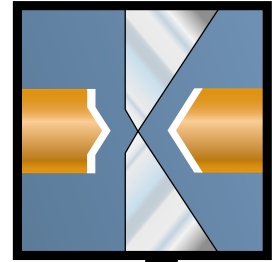

THE FLUSH CUT

The cutting result of most “flush” cutters, their individual terminology notwithstanding, is somewhat similar. Flush cutters also pinch the leads, but at a lower altitude than Micro-Bevel cutters.

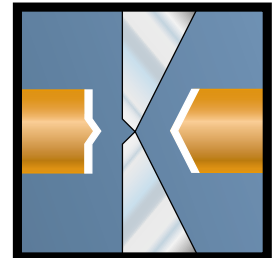



Cutters

These cutters have finer cutting edges than semi-flush or Micro-Bevel cutters.

Lindstrom's flush cut also creates a pinched lead. However, it is configured slightly differently than that produced by other cutters. The Lindstrom flush cutter leaves a narrower and shorter taper along the pinch, thereby reducing the total exposed area. The reason for using a Lindstrom flush cutter rather than the Micro-Bevel is to meet a slightly tighter specification for the cut lead-end or to gain a more flush result to a board, component, or part.

EXCEEDING THE FLUSH CUT

Many manufacturers have a cut which, in reality, is just a smaller pinch, allowing OEMs to meet solderability specifications and alleviate shock. This pinched lead is deemed acceptable for many items produced for high-specification applications, but confusion is caused by the size and height of the pinch as each cut will vary from brand to brand and between manufacturers.

The general consensus is that the greater this pinch becomes, the less the acceptability of the cut. The critical area here is realizing that as the cutter wears down, the size of the pinch increases and could rise above the maximum acceptable height. Moreover, the greater the pinch, the greater the mechanical shock transmitted.

THE ULTRA-FLUSH® CUT

The question to be addressed then is why have a pinch cut at all? Lindstrom engineers have designed the Ultra-Flush cutter which virtually eliminates the pinch other cutters make. The Ultra-Flush configures two flat planes with a barely discernible line separating each of these planar surfaces. Only a precise screw joint and a specially designed radius on the cutting edge could allow this razor-sharp edge to be utilized effectively.

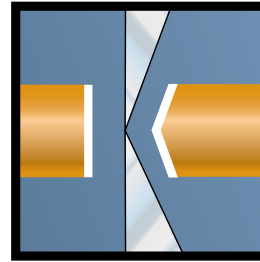

The trade-off in this case is a more limited cutting range and greater possibility for edge damage due to misuse. However, with the exception of Lindstrom's own Micro-Bevel and Flush cutters, the Ultra-Flush will outlast any other “flush” or “shear” type of tool and still match competitive cutting ranges.

The unique design of the Ultra-Flush is perfect for use in close tolerance electronic and medical device assembly where concerns about final lead-end configuration and mechanical shock transmission are a top priority.

Almost all Rx and 80-Series cutters can be equipped with a lead-catcher. See page 102 for more on lead-catchers.

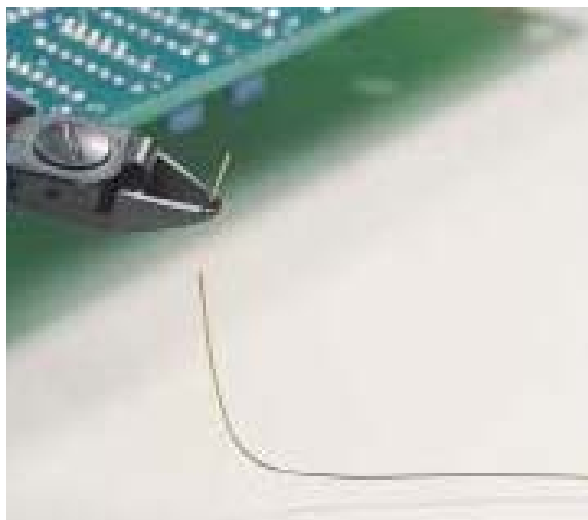



Pliers

PLIERS

EXTENSIONS OF THE HAND

Holding pliers are used on the toughest, most forceful applications – from removing plate steel retaining pins on an oil derrick to the most sensitive and sterile of environments such as surgery. This is because pliers represent the functional expression of replicating and increasing the capabilities of the human hand across many dimensions, particularly of the thumb and adjoining finger, in terms of force and precision.



The 8140 cutter and 7891 holding plier combine capabilities in some electronic "surgery." See page 50 for more on 8140 and page 58 for more on 7891.

That is why holding pliers are available today in an almost limitless number of shapes, styles, configurations, materials and sizes.



PLIER EVALUATION

Evaluating pliers in an objective manner is not a straightforward task. Cutters, for example, can be put on a machine or on the assembly line, and capacity or number of cuts can be tested with some degree of confidence.

Holding pliers are not so easily tested in an objective way – again, because of the almost limitless way in which they are configured and used and also because of their often very long service life.

The forces at work on pliers are also different from cutters. In a cutter, force and wear act on the joint in primarily a single

plane, and the overall concern is the precision with which the joint keeps the edges in alignment together with the performance of the cutting edges and jaws when subject to the impact and wear of continuous cutting. By comparison, the joint in a holding plier must be able to withstand the very high and often simultaneous force of multiple plane actions such as holding and twisting in combination with pushing or pulling.

In addition, in most applications actual wear on the plier jaws is somewhat secondary to the concern with the ultimate strength and resistance to breakage of the jaws with maximum force applied.

Therefore, holding plier performance and capability tend to be strongly influenced by the type and quality



The Rx7890 in an inverted grip is used to straighten a connector pin. See page 48 for more on Rx7890.



Pliers

of construction of the pivot joint used. The consideration of the positives and negatives of each of these constructions can be somewhat different than for cutters. The key is to take these considerations into account together with your intended application and frequency of use so that you can make an informed, cost-effective decision.

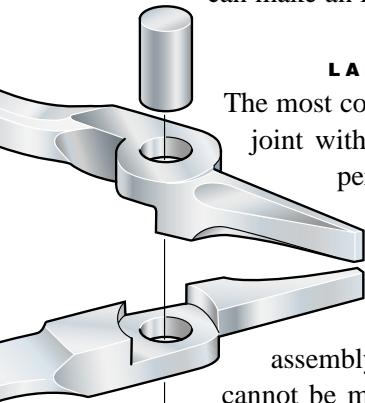

LAP JOINT WITH RIVET

The most common joint used in pliers is the lap joint with rivet. This is due to the cost and performance of such a construction being suitable for many general-purpose tasks. However, lap joint with rivet pliers have a tendency towards a number of problems in assembly tasks where the overall tool itself cannot be made big enough to compensate for the possible weaknesses of this joint. Specifically, the jaws have a tendency to roll over when lead forming, and “play” due to wear can be rapid.

Therefore, although lap joint with rivet pliers often have the lowest price, this joint tends not to have the life or the performance capability often required of small pliers for intricate forming. If the operator is using a larger, medium- to heavy-duty plier, the lap joint with rivet will often suffice as the joint and plier itself are now large enough to offset the joint wear and flex issues present in smaller pliers.

BOX JOINT AND LAP JOINT WITH SCREW

Lindstrom technical analysis has found that the box joint plier or lap joint with screw serves assembly industries best. These allow the plier to retain rigidity, maintaining the correct alignment of the jaws, and preventing “jaw roll” when forming.

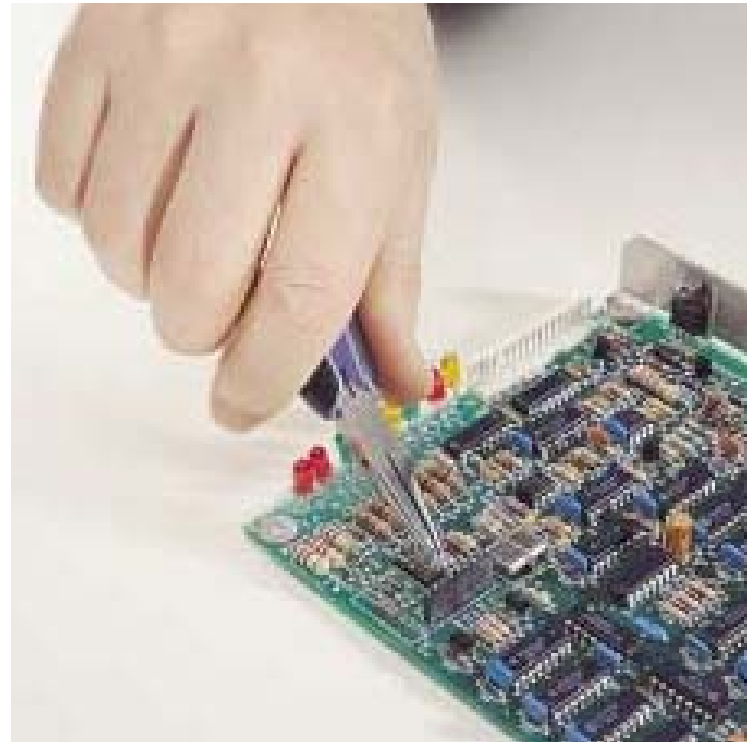
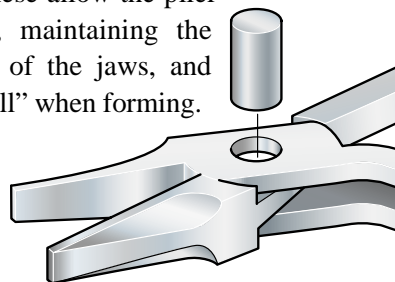

Bent nose Rx7892 allows operator to use an over-hand grip and side access to connector pin and can provide visibility advantages in other applications as well. See page 49 for more on Rx7892.

This condition often is prevalent in other types of pliers and becomes especially obvious as the tool begins to wear and the joint loosens.

The construction of the Lindstrom box joint is of special consideration because it features a unique design and construction. This design allows the slot in the joint to remain undisturbed and thus undistorted when the two halves of the tool are assembled. This results in a joint of greater precision and smoothness, thus ensuring long life with minimal wear.

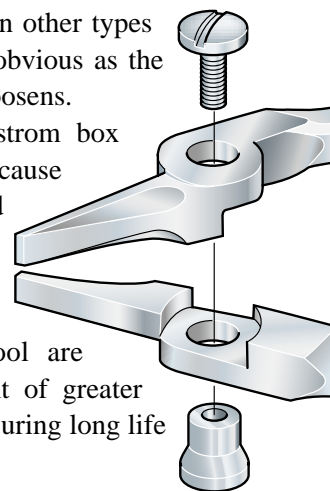



Pliers

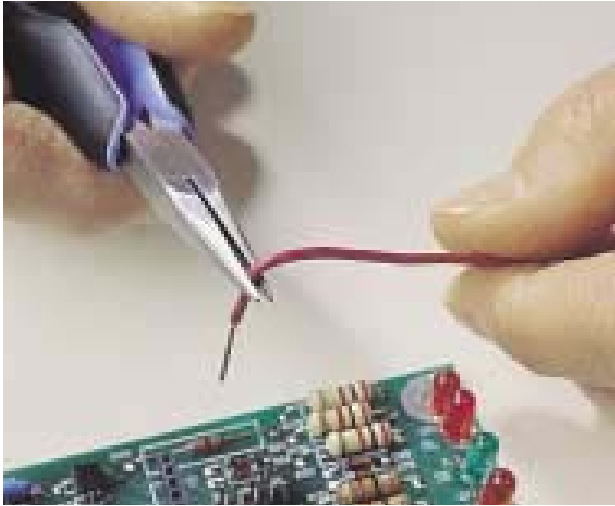

The Rx7890 with a gentle side bevel and strong tips can be used for almost any type of bending and forming. See page 48 for more on Rx7890.

The rigidity of the box joint utilized by Lindstrom allows the plier to be configured with a longer jaw and greater taper. This is advantageous for a number of reasons, some of which are obvious – some of which are not. The longer jaw, in combination with the rigid box joint, allows greater accessibility of work without the concern of “jaw roll.”

Equally important but not so obvious is the opportunity to reduce the number of pliers needed on the workbench. For example, if you are using a lap joint with rivet pliers, separate small needle nose or chain nose pliers may be required for very fine work. Otherwise,

you will have the rolling action common to most lap joint with rivet pliers. However, the greater taper allowed by the rigid Lindstrom box joint plier means that the actual tip of the plier can be much smaller than other types of pliers, relative to the jaw length. This slope greatly increases the range of diameters possible when lead forming. As a consequence, you can utilize fewer tools for more applications. The trade-off once again is the price consideration since the box joint or lap joint with screw pliers are usually priced higher than plain lap joint with rivet types. However, in view of the greater utility of a Lindstrom box joint plier, the ultimate cost is often less.



The Rx7891 (left) with serrations adds additional gripping friction when required. Rx7890 (right) has smooth jaws for reduced possibility to scratch surfaces. See page 48 for more on Rx7890 and Rx7891.



Tweezers

T W E E Z E R S

Throughout the evolution of tweezers as a range, some tweezer styles such as 1, 2, 3C, 5, AA, etc., have remained as identical in design and as popular in usage as in the past. However, even though many tweezer styles carry generic designations, there are variances within each style, depending on the origin. Once the style is determined, special attention should be given to four important criteria:

1. *How are the tweezer tips finished?*
2. *How symmetrical are the two sides?*
3. *How delicate do they feel?*
4. *How easily do they handle small parts?*



Lindstrom "reverse action" (squeeze to release) TL 29D-SA tweezer allows perfect handling and placement of IC's. See page 75 for more on TL 29D-SA.

MATERIALS

Once these factors are determined, then the next step is to decide what tweezer material is to be used. A wide variety of materials are available: Carbon, stainless, special stainless materials, nickel plating, nickel-content, and even beryllium and titanium. However, for use in most assembly or repair situations, three primary types will suffice: carbon, stainless, and special stainless steel.

MATERIAL DESIGNATION

Standardized suffix letters designate materials. These designations are listed below with the consideration for each material.

CARBON STEEL

Carbon steel has strong, flame-hardened tips, but has low rust resistance and can develop a high level of magnetism. If the tweezer is made of Carbon steel, there will be no suffix letter. (Example: "3.")

STAINLESS STEEL

Stainless steel is rust-resistant with reasonably strong tips, but with less hardness and shorter life than carbon. In time, however, they are susceptible to rust and magnetism (care and use factors notwithstanding.)

If the tweezer is made of stainless steel, the tweezer will be designated with the suffix letter "S." (Example: "3-S.")





Tweezers

SPECIAL STAINLESS STEEL

This special stainless steel is 304/305 stainless steel which has excellent anti-acid (resistant to hydrofluoric and nitric acids), anti-magnetic, and rust-resistant properties. Its special properties make it the most popular material used today. If the tweezer is made of this steel, it will be labeled with the suffix "SA." (Example: "3-SA.")

SMD HANDLING TWEEZERS

If SMDs are manipulated by hand, solderable surfaces can be contaminated and lead to faulty joints. Tweezers can alleviate this problem as well as make handling SMDs easier.

In many situations, tweezers are superior to other handling devices such as vacuum pick-ups. For example, in desoldering, tweezers give a firmer grip – especially when dealing with wave soldered components glued to a board. In positioning individual components, tweezers can give the operator better control of location and pressure.

Along with perfect tip alignment and gripping surfaces that fit the shape and size of the component, it is important that the tweezers' paddles or tips have smooth edges and be highly polished and totally free of burrs or marks. If not, then damage to the components or the board itself could result.

The tips should also be at an oblique angle in order to allow the operator the greatest visibility, which is especially important when working with fine pitch components.

The tweezers should have sufficient opening so that manual opening of the handles is not needed. (Reverse action tweezers excepted.)





Design

DESIGN

ERGONOMICS

Professionals used to be satisfied with very durable steel tools. This emphasis on durability meant that almost all attention was focused on the composition of steel, the life of cutting edges, joints, etc. Thus, for many years, the design of high quality tools for professional use in industry has been technology driven, rather than operator oriented.

Today, users are more demanding in terms of function and comfort. As a matter of fact, a growing number of professional users now demand tools that meet the highest standards of performance and simultaneously reduce the risk of injury in the short and long term.





Design

This demand is primarily due to two factors: First, the increased concern with safety at the workplace, particularly with regard to the frequent involvement of both repetitive motions and high force in many industrial tasks, often in combination with poor hand/arm posture caused by the inappropriate design of some traditional handtools. The costs for the use of inappropriate handtools, unsuitable work stations, and job routines will, of course, be shared among the individual operators, the company, and society in the form of direct medical expenses, work lost, reduced quality, training of workers, disruption of work, increased insurance and administrative costs.

Second, this demand reflects the recognition of the importance of quality as well as output volume in many industrial tasks, and the need for tools which enhance not only user capabilities but which also offer the ability to give consistent, high performance results – day in and day out.

By introducing ergonomists and industrial designers into the design process, additional focus is being placed upon industry and operator demands. Thus, the dynamics of tool use, operator preference and the size and shape of the handtool are now all design priorities.

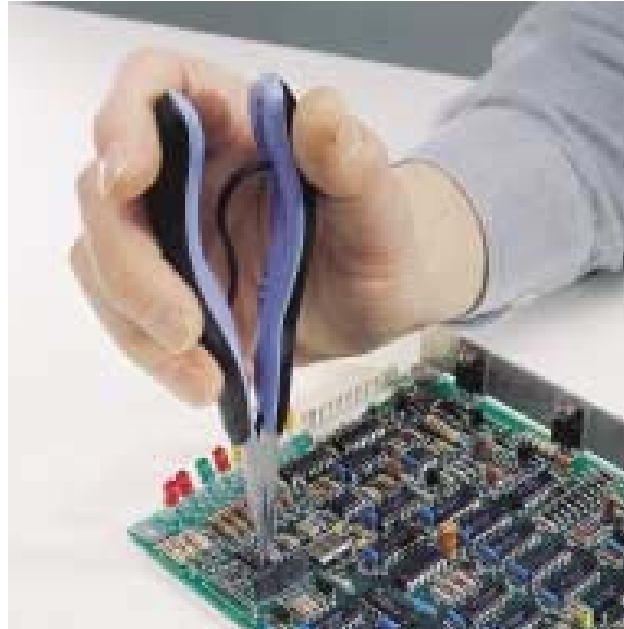

Lindstrom Rx7890 plier exemplifies state - of - the - art handtool design, function and performance. For more on Rx7890 see page 48.





Design

DESIGN PRIORITIES

A good handtool should **reduce the risk of direct injury**. It should:

- *not have any sharp edges on the handle.*
- *minimize wear and tear on the skin.*
- *reduce the risk of users' hands getting caught in tight spots.*
- *reduce the risk of users' hands coming into contact with sharp edges.*
- *be slip-resistant.*

A good handtool should **reduce the risk of long-term injury**. It should:

- *have the optimal weight for its purpose.*
- *have a grip that protects the user from hot and cold temperatures.*
- *minimize the build-up of muscular tension during lengthy jobs.*
- *have a large gripping surface that exerts low, even pressure across the hand.*
- *deliver the greatest possible power with the least possible effort.*
- *be perfectly balanced.*

A good handtool should **make the user's job easier**. It should:

- *be the correct size and design for its purpose.*
- *be able to be used in different positions.*
- *be adjustable in many different positions.*
- *be adjustable – even when wearing gloves.*
- *be designed for use with either hand.*
- *be easy to hold, with the right degree of friction against the skin.*
- *be available in different sizes, suitable for different tasks.*
- *tolerate lubricants and solvents.*

GOOD HANDTOOLS ARE NO ACCIDENT

As a consequence of the demands on modern handtools, good handtools are not developed by accident and are not created in isolation. They have to be developed in collaboration with working professionals, together with specialists in ergonomics and industrial design. Our handtools are good because we take the time to ponder and review the results of this collaboration. They are good because we do not rush. We create better tools by taking one step at a time.

The result? Quite simply, better handtools. We guarantee it. Tools that are:

- **Easier to use.**
- **More comfortable to hold.**
- **Significantly more functional.**
- **Deliver more power.**
- **Give the user a better sense of control.**
- **Enable greater precision.**

Take a look at the Lindstrom Rx cutters and pliers on page 42 and screwdrivers on page 90, for examples of our commitment to meeting your requirements.





Rx Cutters and Pliers

Rx

LINDSTROM Rx
THE ULTIMATE IN PERFORMANCE,
PRECISION AND COMFORT

To be the leader in a competitive field takes dedication, hard work, and practice, which is exactly what Lindstrom has been doing since 1856 – perfecting the best handtools money can buy. For nearly 150 years, we have designed and refined the world's leading cutters and pliers. And in that time, we have learned what works, and what doesn't. But to fully comprehend what makes the Rx the very best, one should take a close look at the Rx and then compare all else on the market to it. The Rx will always come out on top.



Micro-Touch™ is the shape that makes it possible to control and rotate the Rx between thumb and index finger for precision work.

TAKE A CLOSER LOOK AT THE Rx

THE Rx PROFILE

The profile of the Rx grip is slightly rounded and wide, creating excellent surface distribution and contact.



ESD-PROTECTION

The ESD-safe composition of our Rx grips combines resins with conductive additives to produce a material that safely dissipates electrostatic charges, reducing possibility of damage to sensitive components.

WARNING: Rx grips are not insulated and therefore Rx cutters/pliers should never be used on electrified equipment.



Rx Cutters and Pliers

BIO SPRING®

Since it is the traditional nature of a return spring to provide greater resistance the more it is compressed, this has been a challenge for ergonomists whose goal is to make work easier and safer.

The solution lies in Lindstrom's new, patent applied for, BioSpring®, a solution that is as simple as it is ingenious – where the material and design work together to provide new characteristics.



RX PLUS BIO SPRING®

- Tension is kept minimal and limited throughout the working cycle of the tool.
- Handle width is controlled for ease of tool pick-up and handling.
- Tension and opening width can be adjusted to suit your preference via three different ports.
- Almost indestructible in normal use.

RX PLUS BIO SPRING® COMPARED WITH TRADITIONAL SPRINGS

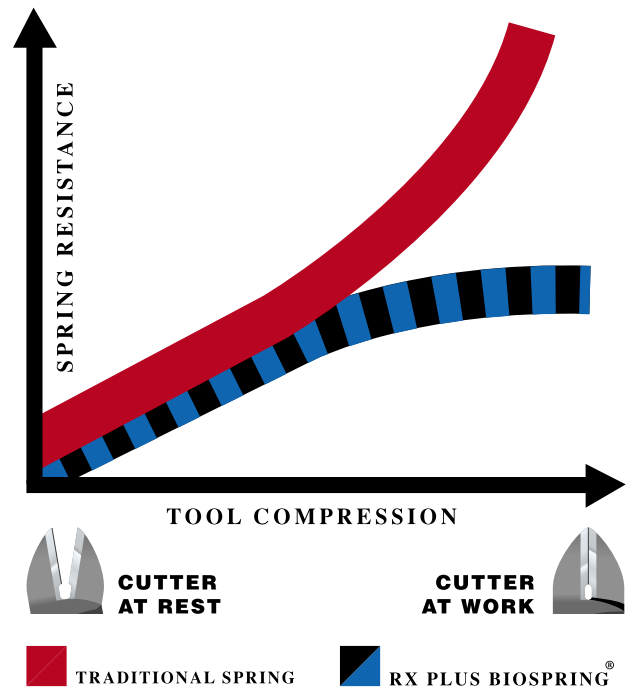

This graph clearly shows the benefit of reduced spring tension offered by the BioSpring® when compared to hand tools that utilize traditional springs.

TO ADJUST RX



1. Pull the tool apart.



2. Place the spring in the desired port.



3. Close the tool.



Rx Cutters and Pliers

1% CARBON/CHROME BALL BEARING GRADE STEEL

Material usually reserved for high stress applications provides incredible impact resistance and resiliency with smoother, cleaner penetration at the cutting edge.

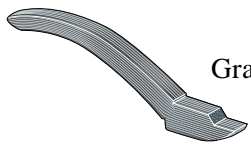

FORGED COMPONENTS

Grain structure follows profile of the blank to maximize tool strength.

CNC GRINDING OF FORGED BLANKS

Computer controlled grinding guarantees edge angle accuracy and contact which increases tool reliability and consistency.

63-65 HRC ON CUTTING EDGES

Precision induction hardening of 1% Carbon/Chrome Ball Bearing Grade Steel allows high Rockwell hardness without brittleness, resulting in a longer lasting tool.

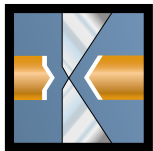

MICRO-BEVEL

MICRO-BEVEL®

Micro-Bevel cutters leave a minimal rise on cut leads resulting in a smaller overall surface soldering area.

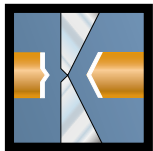

FLUSH

FLUSH

Lindstrom flush cutters leave an even narrower and shorter rise on cut leads than the Micro-Bevel in order to meet a tighter specification for the cut lead-end or to achieve a more flush result to a board, component or part.

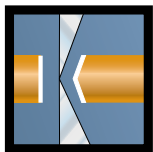

ULTRA-FLUSH

ULTRA-FLUSH®

The unique Ultra-Flush cutters leave a flat surface on cut leads, which is considered to be the ultimate in conformance to tough soldering and mechanical shock specifications.

PRECISION SCREW JOINT

Adjustable screw joint minimizes friction and maximizes alignment of cutting edges.

LEAD-CATCHERS

Lindstrom's patented lead-catcher is an accessory that stops just-cut ends of wire from falling into critical or sensitive areas, which could result in a short circuit or contamination. Almost all Rx cutters can be factory equipped with a leadcatcher. Just add "S" to the tool part number. Ex. Rx 8140-S.





80-Series Cutters

80-SERIES

**LINDSTROM 80-SERIES
TRIED AND TRUE PERFORMANCE
FOR THE TRADITIONAL USER**

Surpassed only by our own Lindstrom Rx range, the Lindstrom 80-Series remains the top choice for the traditional user. This range of cutters offers unsurpassed cutting capacity covering a wide range of wire dimensions and types. The reasons are:

**1% CARBON/CHROME BALL BEARING
GRADE STEEL**

Material usually reserved for high stress applications provides incredible impact resistance and resiliency with smoother, cleaner penetration at the cutting edge.

FORGED COMPONENTS

Grain structure follows profile of the blank to maximize tool strength.

**CNC GRINDING OF
FORGED BLANKS**

Computer controlled machine grinding guarantees edge angle accuracy and contact which increases tool reliability and consistency.

63-65 HRC ON CUTTING EDGES

Precision induction hardening of 1% Carbon/Chrome Ball Bearing Steel allows high Rockwell hardness without brittleness resulting in a longer lasting tool.



MICRO-BEVEL®

Micro-Bevel cutters leave a minimal rise on cut leads resulting in a smaller overall surface soldering area.

FLUSH

Lindstrom flush cutters leave an even narrower and shorter rise on cut leads than the Micro-Bevel in order to meet a tighter specification for the cut lead-end or to achieve a more flush result to a board, component or part.

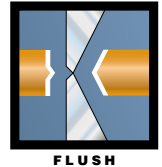

ULTRA-FLUSH®

The unique Ultra-Flush cutters leave a flat surface on cut leads, which is considered to be the ultimate in conformance to tough soldering and mechanical shock specifications.



PRECISION SCREW JOINT

Adjustable screw joint minimizes friction and maximizes alignment of cutting edges.

REPLACEABLE SPRINGS

Due to the long life of 80-Series tools, replaceable springs help reduce down time and stocking of substitute tools.

LEAD-CATCHERS

These patented 80-Series accessories hold cut wires, preventing injury and keeping leads from flying into the assembly. Almost all 80-Series cutters can be factory equipped with a lead-catcher. Just add "S" to the tool part number. Ex. 8140-S.

ESD PROTECTION

All 80-Series cutters can be equipped with DS or CO handles to meet specialized ESD requirements.

WARNING: 80-Series grips are not insulated and therefore 80-Series cutters should never be used on electrified equipment.

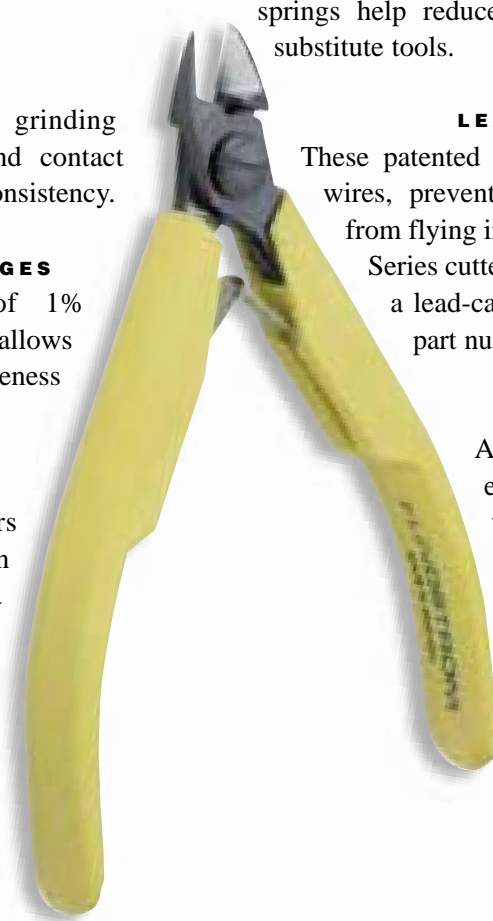



Supreme Cutters and Pliers

SUPREME

**LINDSTROM SUPREME
GOOD PERFORMANCE FOR THE
TRADITIONAL USER**

Good performing cutters and pliers for general electronics work, repair and fine mechanical work.

Most of the cutters and pliers in the Supreme series have a specially made box joint with extra long contact surfaces, made possible by a special manufacturing technique. Undesirable joint movement is held to a minimum, ensuring extremely precise alignment of the jaws, even at the extreme tip.





Multi-Purpose Shear

LINDSTROM MULTI-PURPOSE SHEAR

UNIQUE PERFORMANCE IN DEMANDING TELECOM AND ELECTRONICS APPLICATIONS

As the number of special telecom applications grows, there is an increasing need for cutters that can handle demanding insulation materials such as the Kevlar elements used in fiber optic and other types of cables.

The HS6000 shear is designed to meet these needs with ease. With a durable, precision screw joint and high carbon 57-59 HRC steel blades serrated on one edge, it cuts easily and precisely without letting the material being cut slide away.

Designed to combine ease of use with durability and precision, the HS6000 fits comfortably in either hand while its cushioned ESD-safe non-slip grips provide a secure grasp. Ideal for cutting insulation, cables, ties and all types of corded materials, the HS6000 is a true multi-purpose shear.



ESD-safe.





Tweezers

TWEEZERS

**LINDSTROM TWEEZERS
THE ULTIMATE IN PERFORMANCE
AND PRECISION**

Although tweezers are produced in many countries, firms with years of assembly experience turn to Swiss-made tweezers in order to be assured of the highest precision and consistent uniform quality.

Swiss-made Lindstrom tweezers offer perfect balance, tip alignment, and symmetry as well as a wide range of materials to meet your most sophisticated and demanding requirements. In addition to general assembly, our product line includes models specifically designed for SMDs, ESD-sensitive areas, and medical and laboratory applications as well.

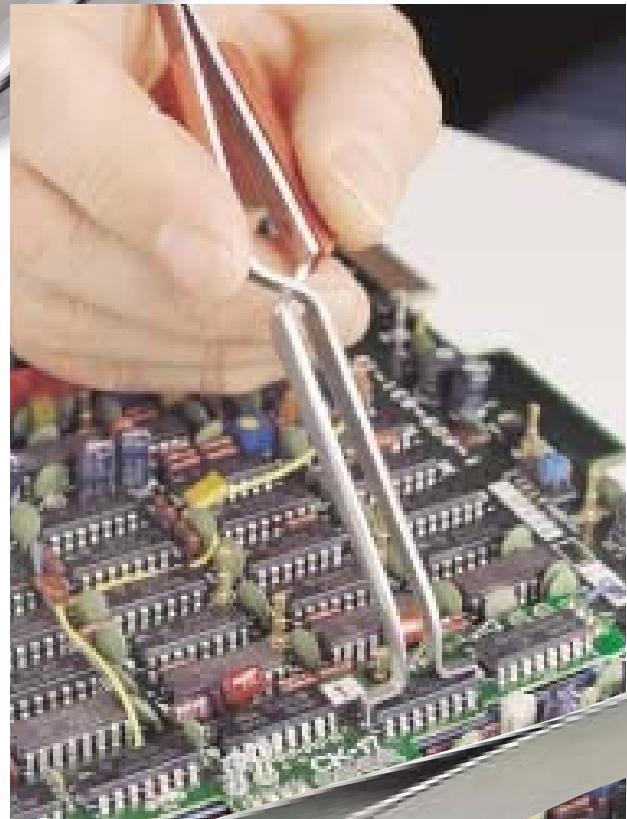



Torque Screwdrivers

TORQUE SCREWDRIVERS

HIGH PRECISION TORQUE CONTROL MADE EASY

With a unique, high-precision cam-over torque-limiting design, Lindstrom's new generation of Torque Screwdrivers virtually eliminate over-application of force, thereby reducing the risk for damage and rework costs. Available in Micro-Adjustable or Preset Torque versions, Lindstrom's Adjustable Torque Screwdrivers offer unmatched user comfort, thanks to a user-friendly shape and non-slip grip. Built to last and with a non-magnetic bit holder that accepts any standard drive, the ideal choice for flexible applications as well as volume production. All models are ESD-safe.

MICRO-ADJUSTABLE TORQUE SCREWDRIVERS

The Micro-Adjustable Torque Screwdriver allows instant change to the torque value with an easy-to-read window scale and a precise pull-to-set, push-to-lock mechanism. Adjustment is easy. Just pull the knob, turn it to the desired torque, push in the knob and it is ready to use!

The Micro-Adjustable Screwdriver series includes three models ranging from 10 to 450 Ncm or 20 in.oz. to 40 in.lbs. Accuracy +/- 6%.



PRESET TORQUE SCREWDRIVERS

Sharing the ruggedness, comfort and precision of the Micro-Adjustable version, the Preset Torque Screwdriver is an excellent choice for volume manufacturing applications. The desired torque value is easily set using an internal adjustment screw accessible by removing the end cap of the handle. The Preset Torque Driver is available in four models, covering a torque range of 4 to 450 Ncm or 6 in.oz. to 40 in.lbs. Accuracy +/- 6%.



All models are ESD-safe.

Certified to the following industry specifications:
ASME B107.14 M-1994 and ISO 6789, EN 26789/1994.



Ergo® Screwdrivers

ERGO® SCREWDRIVERS

THE ULTIMATE IN PERFORMANCE, PRECISION AND COMFORT

Exhaustive studies and tests, both practical and in the laboratory, lie behind the handle design of Ergo® screwdrivers. These studies showed how a screwdriver is really used and how the handle should be designed to obtain a comfortable and effective grip in all conceivable situations.

These tests resulted in a handle that has different diametrics for different functions. The large part of the handle allows high torque to be applied. The small part of the handle can be used with a sensitive touch for speedy tightening or loosening of screws. The fingers can work on the comparatively large diameter of the neck, which means that it is possible to tighten the screw longer with only the fingertips before resistance increases, when the grip is transferred to the upper part of the handle.

The cross-section, material and surface texture of the handle are also the result of extensive research and

testing. Besides being comfortable to use in different work situations, the round and efficiently patterned shape permits high torque to be applied. The handle always fits comfortably in the hand – no sharp edges as on a square handle, for example, which may cut painfully into the hand.

The International Standard as determined by ISO stipulates minimum torque requirements for screwdrivers. The strength of Ergo® screwdrivers exceeds the requirements of the ISO standard by a good margin, in some cases by more than 60%.

The blade is made of specially hardened steel and corrosion protected by plating. The tip is of Pro-point design, which means that it is phosphated for

maximum dimensional accuracy and no peeling. Larger screwdrivers are equipped with a practical hexagonal drive on the blade, so that a wrench can be used whenever a greater torque is needed.

The shape and strength of the screwdriver tips conform to the requirements of national and international standards in accordance with ISO 2380.





Ergo® Screwdrivers

**TAKE A CLOSER LOOK AT
ERGO® SCREWDRIVERS**

- Three-component handle. Combines strong core with good grip.
- Easy to choose the right tip with color-coded handle and symbol on the end. Color and symbol don't wear out.
- Large, rounded end lets you apply force without hurting the palm of your hand.
- Can be hung on a peg or secured by string.
- Only rounded contours. No pressure points, no matter how you hold or use the screwdriver.
- Soft, high-friction material with ridged surface for comfortable grip and maximum friction even when the hand is oily.
- Flat face so the screwdriver won't roll.
- Optimal length on the handle neck. Fingers are always correctly positioned for quick turning and precision control.
- Cylindrical shaft with small diameter to tighten and loosen screws quickly and easily.
- Hexagonal nut on certain models so you can use a wrench if you need to apply extra torque.

Ergo® screwdrivers:

- Easier to use.
- More comfortable to hold.
- Significantly more functional.



SLOTTED



PHILIPS® PH



POZIDRIV® PZ



TORX®



HEXAGON

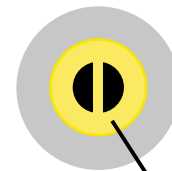

COLOR CODE



Special Engineered Tools

SPECIAL ENGINEERED TOOLS

There is always a need for tools to fulfill certain special requirements that cannot be met by regular production tools. Our Special Engineered Tools are designed for those applications.

The tools pictured here are only a small sampling of the many different designs we have manufactured as solutions to difficult assembly or rework requirements.

The Lindstrom staff can design special application tools by working from “before” and “after” components, engineering drawings, or prototypes. We even build tools drawn on the back of a napkin. It’s that easy!

We can modify tweezers to move tiny wafers without scratching the surface, or build extra-long-nosed pliers for extracting proprietary equipment. We can make one prototype or several hundred.

Our designers have created over 1000 custom tools that were manufactured to perform a wide variety of actions on leads and components. Lindstrom has built specially engineered tools to:



- *Cut and form.*
- *Insert and extract.*
- *Standoff cut.*
- *Straighten.*
- *Cut and swedge.*
- *Hold threaded shafts.*
- *Service custom automated machines.*



(AVAILABLE IN NORTH AMERICA ONLY.)



How To Choose

HOW TO CHOOSE?

Deciding which cutter to use among the very large assortment offered in this catalog can be challenging, to say the least. In addition, there can be several good options to choose from for a given application. We are often asked, “Why do you offer such a large range of handtools, and specifically, so many cutters?” There are two primary reasons for having such a large assortment.

First, the applications served by these tools are almost infinite. From a pure application point of view, more specialized tools are often required to achieve the most cost effective and technically sound result. In addition, requirements in terms of size and composition of materials to be cut or bent and the end result required can change very rapidly in the fast-moving assembly industry. So maintaining a wide assortment gives you assurance that you can find a good solution for future application requirements that you may not have at present.

Secondly, applications are only a part of the reason for such a wide assortment. The fact is that beyond certain basic safety and health guidelines in proper tool usage, operator preference in terms of positioning, visibility, reach, experience, etc., varies greatly from one operator to another, with very few clear “right or wrong” aspects. So rather than trying to convince you to choose from a limited range which is easier for us to make, we would rather completely satisfy your requirements and preferences. And that means we have to offer many variations.

However, even with that understanding, choosing can still be a challenge! Here are some basic suggestions that can help you narrow your choice to a few very good options.



8130
XS / Extra Small



8140
S / Small



7893
S / Small



8150
M / Medium



8160
L / Large



7890
M / Medium

All tools above shown actual size





How To Choose

WHAT KIND OF CUTTING RESULT DO YOU WANT?

1. If the cutting result is not critical, then go with the Micro-Bevel as this cutting edge bevel gives you the best capacity and life in most applications.
2. Use the Flush if Micro-Bevel is not suitable.
3. Use the Ultra-Flush only when required, as it requires the most care in use.

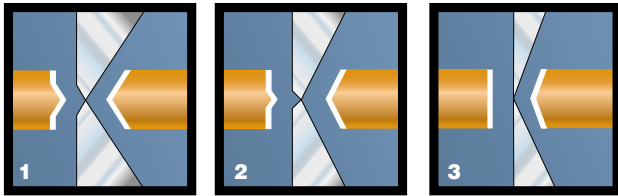

WHAT ARE THE TYPES AND DIAMETERS OF MATERIAL YOU WANT TO CUT?

All of our cutters are rated for copper wire. However, quite often you are not cutting simple copper wire.

But we rate them for copper as that is a standard that almost all can relate to. Some cutters are also rated for tougher material such as spring wire. Again, you are not likely to be cutting spring wire either.

However, almost everything else you are cutting will fall in toughness between copper and spring wire.

So here you have to use a bit of common sense. For instance: Is the material a little tougher than copper or a lot? This will further narrow the field by eliminating the cutters not likely suitable for the application.

IS ACCESS (SPACE AVAILABILITY) TO THE APPLICATION AN ISSUE?

If access is not a challenge, then lean towards an Oval head - in as large a size as possible - as this is the strongest type of head configuration. One basic fact of the assembly and repair environment is that a cutter on a workbench or in the field will at one time or another be used on something either larger or harder than the original intended application. This is when having chosen a Lindstrom, which is “over-engineered” and conservatively rated to begin with and the strongest and largest configuration in the Lindstrom range that can be used for the application, makes sense. And saves you a lot of money - the tool will much more easily survive occasional misuse and continue to give good results.

If access is an issue, then try to use a smaller Oval head. If that puts you out of cutting range or is still too large at the tip, then move over to a Tapered head.

If a Tapered head still doesn't fit the application, then go with the Tapered and Relieved head.

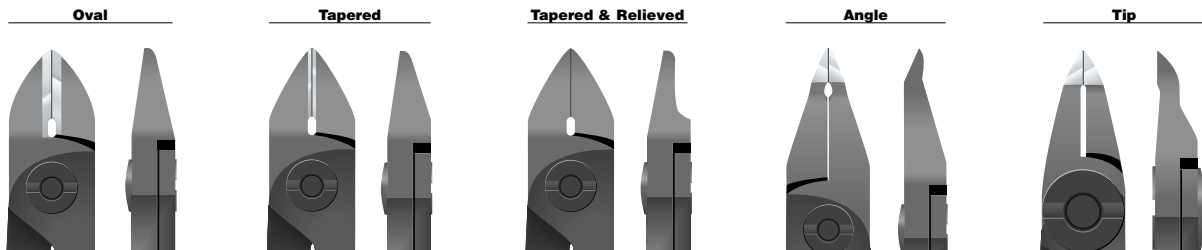



How To Choose

IS REACH OR ANGLE TO THE APPLICATION AN ISSUE?

Then consider an angle or tip cutter. However, keep in mind that the smallest configurations in this type should then be reserved for that application and used with considerable care.



DO YOU REQUIRE ESD PROTECTION ON YOUR HANDTOOLS?

If so, then select from the Rx range or order 80-Series or Supreme ranges with ESD-safe handles installed.

DO YOU REQUIRE LEAD-CATCHERS TO KEEP CUT LEADS FROM GOING INTO SENSITIVE AREAS?

If so, then simply add an "S" suffix after the cutter part number to have a lead-catcher installed.

CONTACT US

If you still have questions about which tools are best suited for your application, we strongly encourage you to contact one of our factory trained salespeople. Our representatives can make informed recommendations or furnish tools for evaluation where they provide the best opportunity for you to observe their value – on the job. On our Website, www.lindstromtools.com, you will find our world-wide presence and can easily locate a Lindstrom professional ready to help you find the right tool for the job.

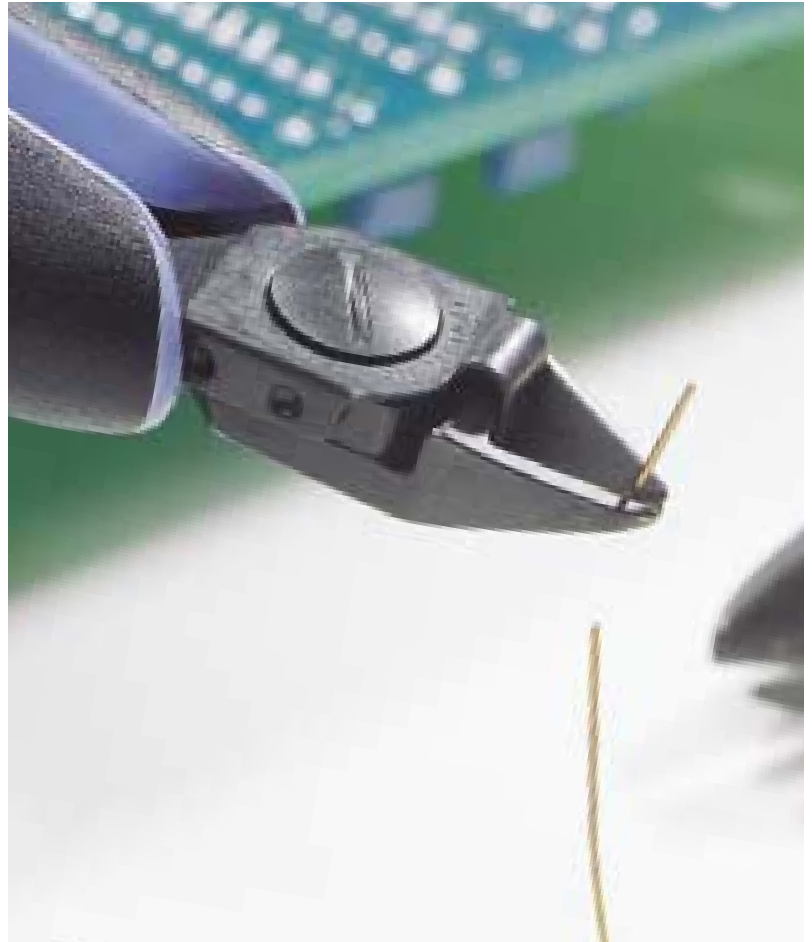



Capacity and Options

											CUTTING CAPACITY					
PART NO. ¹	SIZE	SHAPE	CUT OR SURFACE	HANDLE OPTIONS				L / C	PAGE	COPPER WIRE						
				Rx	CO	DS	HS			GAUGE	38	24	18	15	12	
										INCH	.004	.02	.039	.059	.079	
											MM	0.1	0.5	1.0	1.5	2.0
CUTTERS	8130	XS	O	MB	■	■	■	■	✓	42, 50						
	8131	XS	O	F	■	■	■	■	✓	42, 50						
	8132	XS	O	UF	■	■	■	■	✓	42, 50						
	8140	S	O	MB	■	■	■	■	✓	42, 50						
	8141	S	O	F	■	■	■	■	✓	42, 50						
	8142	S	O	UF	■	■	■	■	✓	42, 50						
	8143	S	T	MB	■	■	■	■	✓	43, 51						
	8144	S	T	F	■	■	■	■	✓	43, 51						
	8145	S	T	UF	■	■	■	■	✓	43, 51						
	8146	S	T&R	MB	■	■	■	■	✓	43, 51						
	8147	S	T&R	F	■	■	■	■	✓	43, 51						
	8148	S	T&R	UF	■	■	■	■	✓	43, 51						
	8149	S	TP	F	■	■	■	■		44, 52						
	8150	M	O	MB	■	■	■	■	✓	42, 50						
	8150 J ²	M	O	MB	■	■	■	■	✓	50						
	8151	M	O	F	■	■	■	■	✓	42, 50						
	8152	M	O	UF	■	■	■	■	✓	42, 50						
	8153	M	T	MB		■	■	■	✓	43, 51						
	8154	M	T	F		■	■	■	✓	43, 51						
	8155	M	T	UF		■	■	■	✓	43, 51						
	8156	M	T&R	MB		■	■	■	✓	51						
	8157	M	T&R	F		■	■	■	✓	51						
	8158	M	T&R	UF		■	■	■	✓	51						
	8160	L	O	MB	■	■	■	■	✓	42, 50						
	8160 J ²	L	O	MB	■	■	■	■		50						
	8161	L	O	F	■	■	■	■	✓	42, 50						
	8162	L	O	UF	■	■	■	■	✓	42, 50						
	8163	L	T	MB		■	■	■	✓	51						
	8164	L	T	F		■	■	■	✓	51						
	8165	L	T	UF		■	■	■	✓	51						
8211	S	A 20°	F	■	■	■	■		45							
8233	XS	T 10°	UF	■	■	■	■		44							
8234	XS	T 10°	UF	■	■	■	■		45							
8237	XS	A 50°	UF	■	■	■	■		46							
8247	S	A 45°	F	■	■	■	■	✓	46							
8248	S	A 45°	F	■	■	■	■		47, 53							
7190	S	T	MB		■	■	■		54							
7191	S	T	F		■	■	■		54							
7280	S	A	F		■	■	■		55							
7285	S	A	F		■	■	■		55							
7290	S	A	MB		■	■	■		56							
7291	S	A	F		■	■	■		56							
7292	S	ED	F		■	■	■		57							
7293	S	A	F		■	■	■		56							
PLIERS	7490	S		SM	■	■	■		47, 57							
	7590	S		SM	■	■	■		48, 58							
	7890	M		SM	■	■	■		48, 58							
	7891	M		SE	■	■	■		48, 58							
	7892	M		SM	■	■	■		49, 59							
	7893	S		SM	■	■	■		49, 59							

1 All part numbers as listed come standard with molded plastic handles and springs.

2 Type "J" edges for stripping and cutting insulated copper wire.

3 Max .16"/.4 mm springwire.



Capacity and Options

SIZE				ACTUAL SIZE	
XS	Extra Small				
S	Small				
M	Medium				
L	Large				
SHAPE					
O	Oval				
T	Tapered				
T&R	Tapered & Relieved				
A	Angle				
TP	Tip				
ED	End				
CUT OR SURFACE					
MB	Micro-Bevel				
F	Flush				
UF	Ultra-Flush				
SM	Smooth				
SE	Serrated				
HANDLE OPTIONS					
RX	The ultimate in ergonomic and ESD safe handles.				
CO	Standard handle shape in conductive material.				
DS	Slip-on handle in dissipative material. (E.U. only)				
HS	Traditional ergonomic handle shape in dissipative material. (U.S. only)				
To order handle options, add two letter prefix to part no. = Rx8130.					
LEAD CATCHER					
L/C	Lead-Catcher available, add "S" suffix to part no. = 8130-S.				

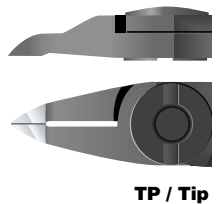
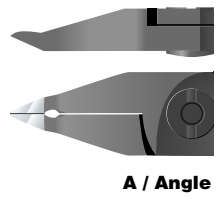
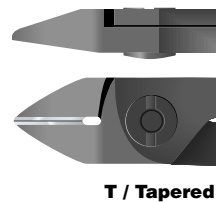
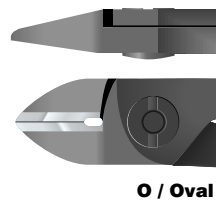
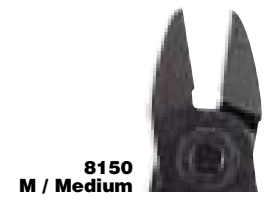



Rx Cutters and Pliers

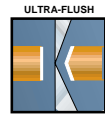
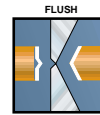
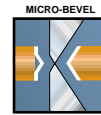

O V A L

Rx8130-8162

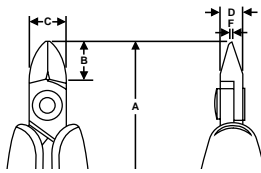



Product code	EAN code 731415+	A mm inch	B mm inch	C mm inch	D mm inch	F mm inch	Capacity mm inch	Bevel		
Rx8130	0103003	133.5 5.25	8.5 0.33	8.0 0.31	5.0 0.20	0.8 0.03	0.2 - 1.25 0.01 - 0.05	Micro	68	1
Rx8131	0103010	133.5 5.25	8.5 0.33	8.0 0.31	5.0 0.20	0.8 0.03	0.1 - 1.25 0.01 - 0.05	Flush	68	1
Rx8132	0103027	133.5 5.25	8.5 0.33	8.0 0.31	5.0 0.20	0.8 0.03	0.1 - 0.8 0.01 - 0.03	Ultra	68	1
Rx8140	0103034	135.5 5.33	10.5 0.41	10.0 0.39	6.0 0.24	0.8 0.03	0.2 - 1.25 0.01 - 0.05	Micro	70	1
Rx8141	0103041	135.5 5.33	10.5 0.41	10.0 0.39	6.0 0.24	0.8 0.03	0.1 - 1.25 0.01 - 0.05	Flush	70	1
Rx8142	0103058	135.5 5.33	10.5 0.41	10.0 0.39	6.0 0.24	0.8 0.03	0.1 - 1.0 0.01 - 0.04	Ultra	70	1
Rx8150	0103133	138.0 5.43	13.0 0.51	12.5 0.49	6.0 0.24	1.2 0.05	0.3 - 1.6 0.01 - 0.06	Micro	73	1
Rx8151	0103140	138.0 5.43	13.0 0.51	12.5 0.49	6.0 0.24	1.2 0.05	0.2 - 1.6 0.01 - 0.06	Flush	73	1
Rx8152	0103157	138.0 5.43	13.0 0.51	12.5 0.49	6.0 0.24	1.2 0.05	0.2 - 1.25 0.01 - 0.05	Ultra	73	1
Rx8160	0111534	147.0 5.8	16.0 0.63	16.0 0.63	8.0 0.31	1.6 0.06	0.4 - 2.0 0.02 - 0.08	Micro	97	1
Rx8161	0111541	147.0 5.8	16.0 0.63	16.0 0.63	8.0 0.31	1.6 0.06	0.3 - 2.0 0.01 - 0.08	Flush	97	1
Rx8162	0111568	147.0 5.8	16.0 0.63	16.0 0.63	8.0 0.31	1.6 0.06	0.3 - 1.6 0.01 - 0.06	Ultra	97	1



Rx Cutters and Pliers



TAPERED

Product code	EAN code 731415+	A mm inch	B mm inch	C mm inch	D mm inch	F mm inch	Capacity mm inch	Bevel		
Rx8143	0103065	135.5 5.33	10.5 0.41	10.0 0.39	6.0 0.24	0.8 0.03	0.2 - 1.25 0.01 - 0.05	Micro	68	1
Rx8144	0103072	135.5 5.33	10.5 0.41	10.0 0.39	6.0 0.24	0.8 0.03	0.1 - 1.25 0.01 - 0.05	Flush	68	1
Rx8145	0103089	135.5 5.33	10.5 0.41	10.0 0.39	6.0 0.24	0.8 0.03	0.1 - 1.0 0.01 - 0.04	Ultra	68	1

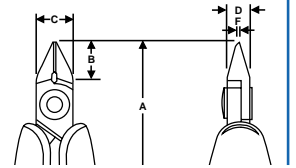
Rx8143-8145



TAPERED AND RELIEVED

Product code	EAN code 731415+	A mm inch	B mm inch	C mm inch	D mm inch	F mm inch	Capacity mm inch	Bevel		
Rx8146	0103096	135.5 5.33	10.5 0.41	10.0 0.39	6.0 0.24	0.8 0.03	0.2 - 1.0 0.01 - 0.04	Micro	68	1
Rx8147	0103102	135.5 5.33	10.5 0.41	10.0 0.39	6.0 0.24	0.8 0.03	0.1 - 1.0 0.01 - 0.04	Flush	68	1
Rx8148	0103119	135.5 5.33	10.5 0.41	10.0 0.39	6.0 0.24	0.8 0.03	0.1 - 0.8 0.01 - 0.03	Ultra	68	1

Rx8146-8148

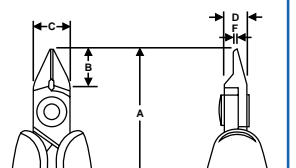
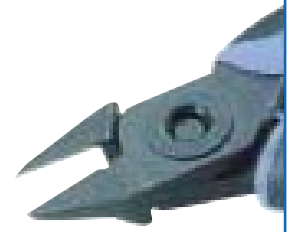



Rx Cutters and Pliers

TIP

Rx8149

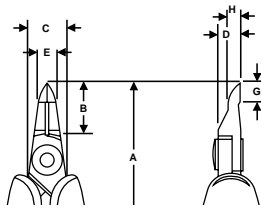

Product code	EAN code	A mm inch	B mm inch	C mm inch	D mm inch	E mm inch	G mm inch	H mm inch	Capacity mm inch	Bevel		
Rx8149	0103126	139.0 5.47	14.0 0.55	10.0 0.39	6.0 0.24	5.0 0.20	5.0 0.20	3.2 0.13	0.1 - 0.6 0.01 - 0.02	Flush	70	1

MICRO TIP

LONG HEAD, 10°

NEW

Rx8233

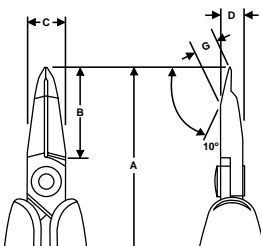

Product code	EAN code	A mm inch	B mm inch	C mm inch	D mm inch	F mm inch	G mm inch	Capacity mm inch	Bevel		
Rx8233	0113521	149.0 5.9	22.3 0.87	10.6 0.41	7.0 0.27	2.3 0.08	7.2 0.28	0.1 - 0.65 0.004 - 0.025	Ultra	69	1

Available in selected markets.





Rx Cutters and Pliers

M I C R O T I P

SHORT HEAD, 10°

NEW

Rx8234

Product code	EAN code	A mm inch	B mm inch	C mm inch	D mm inch	F mm inch	G mm inch	Capacity mm inch	Bevel		
Rx8234	0113538	141.0 4.5	14.2 0.56	10.6 0.41	7.0 0.27	1.6 0.06	3.2 0.12	0.05 - 0.4 0.002 - 0.18	Ultra	62	1

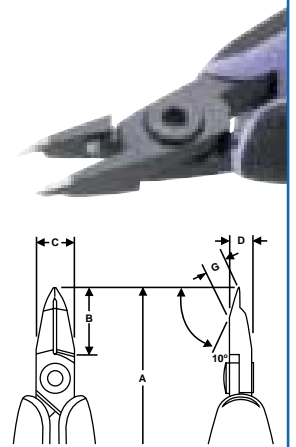

Available in selected markets.



A N G L E

SHORT HEAD, 20°

Rx8211

Product code	EAN code	A mm inch	B mm inch	C mm inch	D mm inch	G mm inch	Capacity mm inch	Bevel		
Rx8211	0103188	134.5 5.29	9.5 0.37	10.0 0.39	6.0 0.24	4.1 0.16	0.2 - 1.2 0.01 - 0.05	Flush	70	1

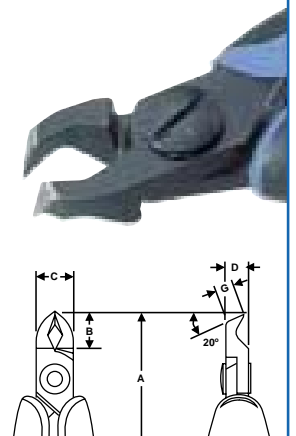





Rx Cutters and Pliers

M I C R O T I P , A N G L E

LONG HEAD, RELIEVED 50°

NEW

Rx8237

Product code	EAN code	A mm inch	B mm inch	C mm inch	D mm inch	F mm inch	G mm inch	Capacity mm inch	Bevel		
Rx8237	0113545	144.0 5.6	17.4 0.69	10.6 0.41	7.0 0.27	1.6 0.06	4.1 0.16	0.1 - 0.65 0.004 - 0.025	Ultra	65	1

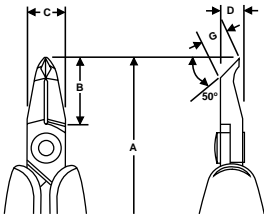

Available in selected markets.



A N G L E

LONG HEAD, 45°

Rx8247

Product code	EAN code	A mm inch	B mm inch	C mm inch	D mm inch	G mm inch	Capacity mm inch	Bevel		
Rx8247	0103164	143.0 5.63	18.0 0.71	10.0 0.39	6.0 0.24	6.7 0.26	0.2 - 1.0 0.01 - 0.04	Flush	72	1

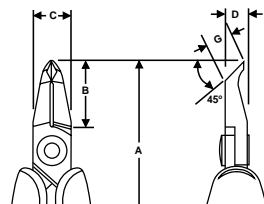





Rx Cutters and Pliers

ANGLE

**LONG HEAD,
RELIEVED 45°**

Rx8248

Product code	EAN code	A mm inch	B mm inch	C mm inch	D mm inch	G mm inch	Capacity mm inch	Bevel		
Rx8248	0103171	143.0 5.63	18.0 0.71	10.0 0.39	6.0 0.24	6.7 0.26	0.2 - 0.8 0.01 - 0.03	Flush	72	1

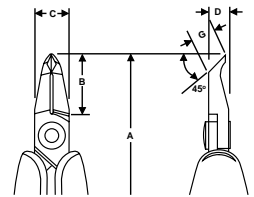

PLIERS

FLAT NOSE

Rx7490

Product code	EAN code	A mm inch	B mm inch	C mm inch	D mm inch	E mm inch	F mm inch	Jaw shape		
Rx7490	0103195	146.5 5.77	20.0 0.79	9.0 0.35	6.7 0.26	1.2 0.05	3.2 0.12	Smooth	70	1

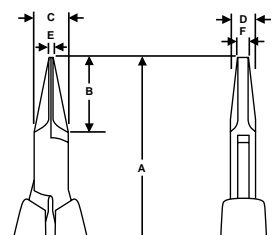





Rx Cutters and Pliers

PLIERS

ROUND NOSE

Rx7590



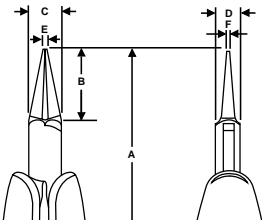

Product code	EAN code	A mm inch	B mm inch	C mm inch	D mm inch	E mm inch	F mm inch	Jaw shape		
Rx7590	0103201	146.5 5.77	20.0 0.79	9.0 0.35	6.7 0.26	1.0 0.04	Ø 0.5 Ø 0.02	Very fine	69	1



SNIPE NOSE

Rx7890-7891



Product code	EAN code	A mm inch	B mm inch	C mm inch	D mm inch	E mm inch	F mm inch	Jaw shape		
Rx7890	0103218	158.5 6.24	32.0 1.26	9.0 0.35	6.0 0.24	1.2 0.05	0.8 0.03	Smooth	72	1
Rx7891	0103225	158.5 6.24	32.0 1.26	9.0 0.35	6.0 0.24	1.2 0.05	0.8 0.03	Serrated	72	1

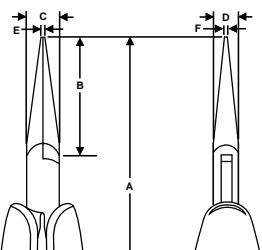





Rx Cutters and Pliers

PLIERS

SHOULDER SNIP WITH BENT TIP



Product code	EAN code	A mm inch	B mm inch	C mm inch	D mm inch	E mm inch	F mm inch	Jaw shape		
Rx7892	0103232	155.5 6.12	29.0 1.14	9.0 0.35	6.7 0.26	1.2 0.05	0.8 0.03	Smooth	73	1

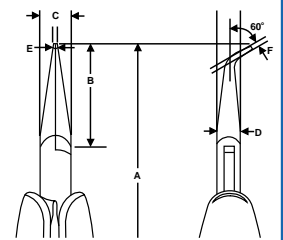

Rx7892



SHORT SHOULDER SNIP

Product code	EAN code	A mm inch	B mm inch	C mm inch	D mm inch	E mm inch	F mm inch	Jaw shape		
Rx7893	0103249	146.5 5.77	20.0 0.79	9.0 0.35	6.7 0.26	1.2 0.05	0.8 0.03	Smooth	71	1



Rx7893

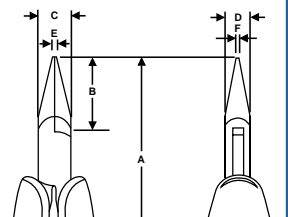



80-Series Cutters

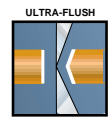
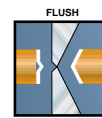
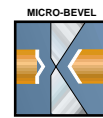

O V A L

8130-8162

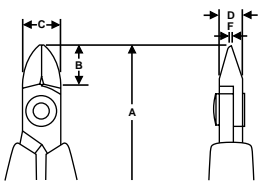

Product code	EAN code 731415+	A mm inch	B mm inch	C mm inch	D mm inch	F mm inch	Capacity mm inch	Bevel	g	
8130	0050918	108.0 4.25	8.0 0.31	8.0 0.31	5.0 0.20	0.8 0.03	0.2 - 1.25 0.01 - 0.05	Micro	43	1
8131	0050925	108.0 4.25	8.0 0.31	8.0 0.31	5.0 0.20	0.8 0.03	0.1 - 1.25 0.01 - 0.05	Flush	43	1
8132	0050932	108.0 4.25	8.0 0.31	8.0 0.31	5.0 0.20	0.8 0.03	0.1 - 0.8 0.01 - 0.03	Ultra	44	1
8140	0050949	110.0 4.33	10.0 0.39	10.0 0.39	6.0 0.24	0.8 0.03	0.2 - 1.25 0.01 - 0.05	Micro	46	1
8141	0050987	110.0 4.33	10.0 0.39	10.0 0.39	6.0 0.24	0.8 0.03	0.1 - 1.25 0.01 - 0.05	Flush	45	1
8142	0051007	110.0 4.33	10.0 0.39	10.0 0.39	6.0 0.24	0.8 0.03	0.1 - 1.0 0.01 - 0.04	Ultra	46	1
8150	0051113	112.5 4.43	12.5 0.50	12.5 0.50	6.0 0.24	1.2 0.05	0.3 - 1.6 0.01 - 0.06	Micro	50	1
8150J	0051137	112.5 4.43	12.5 0.50	12.5 0.50	6.0 0.24	1.2 0.05	Max 0.5 Max 0.02	Micro	49	1
8151	0051199	112.5 4.43	12.5 0.50	12.5 0.50	6.0 0.24	1.2 0.05	0.2 - 1.6 0.01 - 0.06	Flush	49	1
8152	0052097	112.5 4.43	12.5 0.50	12.5 0.50	6.0 0.24	1.2 0.05	0.2 - 1.25 0.01 - 0.05	Ultra	49	1
8160	0051229	125.0 4.92	16.0 0.63	16.0 0.63	8.0 0.31	1.6 0.06	0.4 - 2.0 0.02 - 0.08	Micro	88	1
8160J	0051250	125.0 4.92	16.0 0.63	16.0 0.63	8.0 0.31	1.6 0.06	Max 0.5 Max 0.02	Micro	87	1
8161	0051328	125.0 4.92	16.0 0.63	16.0 0.63	8.0 0.31	1.6 0.06	0.3 - 2.0 0.01 - 0.08	Flush	88	1
8162	0051335	125.0 4.92	16.0 0.63	16.0 0.63	8.0 0.31	1.6 0.06	0.3 - 1.6 0.01 - 0.06	Ultra	88	1

Type "J" edges for stripping and cutting insulated copper wire.





If an 80-series cutter is desired with ESD-safe sleeves, then add the suffix CO or DS to the product code (Example: 8162 CO)



80-Series Cutters



TAPERED

Product code	EAN code 731415+	A mm inch	B mm inch	C mm inch	D mm inch	F mm inch	Capacity mm inch	Bevel		
8143	0051021	110.0 4.33	10.0 0.39	10.0 0.39	6.0 0.24	0.8 0.03	0.2 - 1.25 0.01 - 0.05	Micro	46	1
8144	0051045	110.0 4.33	10.0 0.39	10.0 0.39	6.0 0.24	0.8 0.03	0.1 - 1.25 0.01 - 0.05	Flush	46	1
8145	0051052	110.0 4.33	10.0 0.39	10.0 0.39	6.0 0.24	0.8 0.03	0.1 - 1.0 0.01 - 0.04	Ultra	46	1
8153	0051205	112.5 4.43	12.5 0.50	12.5 0.50	6.0 0.24	1.2 0.05	0.3 - 1.6 0.01 - 0.06	Micro	49	1
8154	0052103	112.5 4.43	12.5 0.50	12.5 0.50	6.0 0.24	1.2 0.05	0.2 - 1.6 0.01 - 0.06	Flush	49	1
8155	0052110	112.5 4.43	12.5 0.50	12.5 0.50	6.0 0.24	1.2 0.05	0.2 - 1.25 0.01 - 0.05	Ultra	49	1
8163	0051342	125.0 4.92	16.0 0.63	16.0 0.63	8.0 0.31	1.6 0.06	0.4 - 2.0 0.02 - 0.08	Micro	88	1
8164	0052141	125.0 4.92	16.0 0.63	16.0 0.63	8.0 0.31	1.6 0.06	0.3 - 2.0 0.01 - 0.08	Flush	88	1
8165	0052158	125.0 4.92	16.0 0.63	16.0 0.63	8.0 0.31	1.6 0.06	0.3 - 1.6 0.01 - 0.06	Ultra	88	1

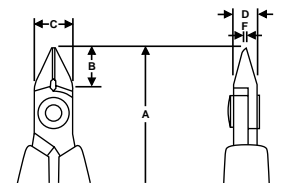
8143-8165



TAPERED AND RELIEVED

Product code	EAN code 731415+	A mm inch	B mm inch	C mm inch	D mm inch	F mm inch	Capacity mm inch	Bevel		
8146	0051076	110.0 4.33	10.0 0.39	10.0 0.39	6.0 0.24	0.8 0.8	0.2 - 1.0 0.01 - 0.04	Micro	46	1
8147	0051083	110.0 4.33	10.0 0.39	10.0 0.39	6.0 0.24	0.8 0.8	0.1 - 1.0 0.01 - 0.04	Flush	46	1
8148	0051090	110.0 4.33	10.0 0.39	10.0 0.39	6.0 0.24	0.8 0.8	0.1 - 0.8 0.01 - 0.03	Ultra	45	1
8156	0051212	112.5 4.43	12.5 0.50	12.5 0.50	6.0 0.24	1.0 1.0	0.3 - 1.25 0.01 - 0.05	Micro	49	1
8157	0052127	112.5 4.43	12.5 0.50	12.5 0.50	6.0 0.24	1.0 1.0	0.2 - 1.25 0.01 - 0.05	Flush	49	1
8158	0052134	112.5 4.43	12.5 0.50	12.5 0.50	6.0 0.24	1.0 1.0	0.2 - 1.0 0.01 - 0.04	Ultra	49	1

8146-8158

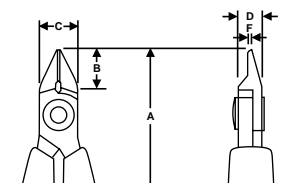



80-Series Cutters

TIP

8149

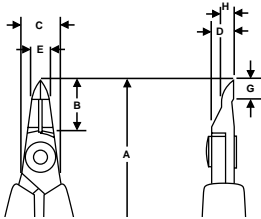

Product code	EAN code	A mm inch	B mm inch	C mm inch	D mm inch	E mm inch	G mm inch	H mm inch	Capacity mm inch	Bevel		
8149	0051106	114.0 4.49	14.0 0.55	5.0 0.23	6.0 0.24	5.0 0.23	5.0 0.23	3.2 0.13	0.1 - 0.6 0.01 - 0.02	Flush	48	1

ANGLE

SHORT HEAD, 20°

8211

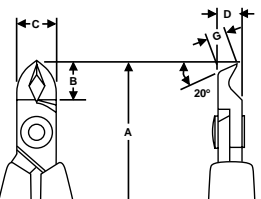

Product code	EAN code	A mm inch	B mm inch	C mm inch	D mm inch	G mm inch	Capacity mm inch	Bevel		
8211	0101030	110.0 4.33	9.5 0.37	10.0 0.39	6.0 0.24	4.1 0.16	0.2 - 1.2 0.01 - 0.05	Flush	43	1





80-Series Cutters

ANGLE

LONG HEAD, 45°

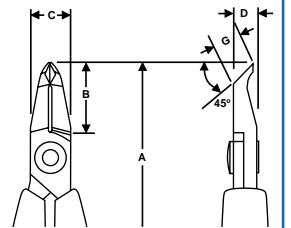

8247

Product code	EAN code	A mm inch	B mm inch	C mm inch	D mm inch	G mm inch	Capacity mm inch	Bevel		
8247	0051397	117.5 4.63	18.0 0.71	10.0 0.39	6.0 0.24	6.7 0.26	0.2 - 1.0 0.01 - 0.04	Flush	51	1



LONG HEAD, RELIEVED, 45°

8248

Product code	EAN code	A mm inch	B mm inch	C mm inch	D mm inch	G mm inch	Capacity mm inch	Bevel		
8248	0051427	117.5 4.63	18.0 0.71	10.0 0.39	6.0 0.24	6.7 0.26	0.2 - 0.8 0.01 - 0.03	Flush	51	1

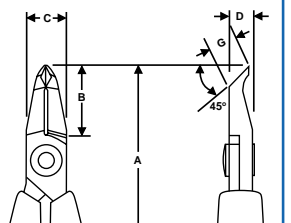



Supreme Cutters and Pliers

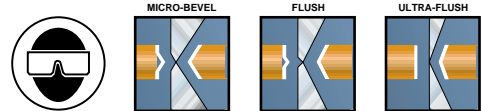

TAPERED

7190-7191

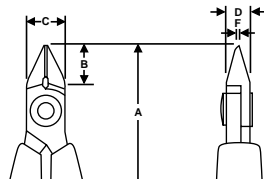

Product code	EAN code	A mm inch	B mm inch	C mm inch	D mm inch	F mm inch	Capacity mm inch	Bevel		
7190	0052479	109.0 4.29	9.0 0.35	9.0 0.35	6.0 0.24	1.0 0.04	0.2 - 1.25 0.01 - 0.05	Micro	50	1
7191	0052509	109.0 4.29	9.0 0.35	9.0 0.35	6.0 0.24	1.0 0.04	0.1 - 1.25 0.01 - 0.05	Flush	50	1





If a Supreme cutter or pliers is desired with ESD-safe sleeves, then add the suffix CO or DS to the product code (Example: 7190 CO)



Supreme Cutters and Pliers



ANGLE

Product code	EAN code	A mm inch	B mm inch	C mm inch	D mm inch	G mm inch	Capacity mm inch	Bevel		
7280	0052523	118.0 4.64	18.0 0.71	9.0 0.35	6.0 0.24	3.5 0.14	0.2 - 0.8 0.01 - 0.03	Flush	54	10

REVERSE

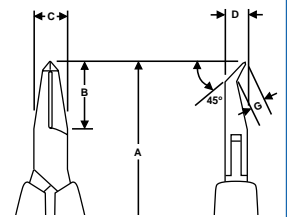
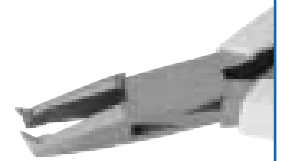
7280



Product code	EAN code	A mm inch	B mm inch	C mm inch	D mm inch	G mm inch	Capacity mm inch	Bevel		
7285	0052530	120.0 4.72	20.0 0.79	9.0 0.35	6.0 0.24	6.7 0.26	0.2 - 1.0 0.01 - 0.04	Flush	56	1

MINIATURE

7285

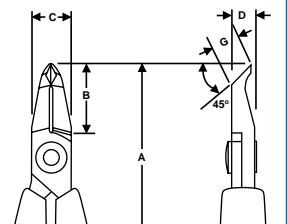





Supreme Cutters and Pliers

ANGLE

END

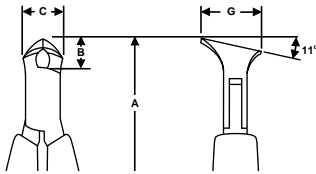
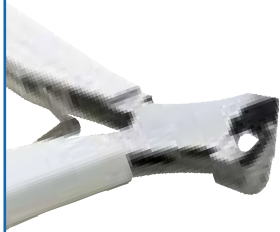

7290-7291

Product code	EAN code	A mm inch	B mm inch	C mm inch	G mm inch	Capacity mm inch	Bevel		
7290	0052547	108.0 4.25	8.0 0.31	10.5 0.41	15.0 0.59	0.35 - 1.25 0.01 - 0.05	Micro	56	1
7291	0052554	108.0 4.25	8.0 0.31	10.5 0.41	15.0 0.59	0.35 - 1.25 0.01 - 0.05	Flush	56	1



END

7293

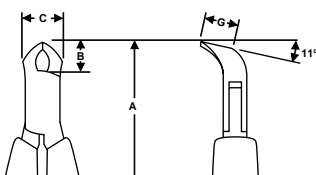
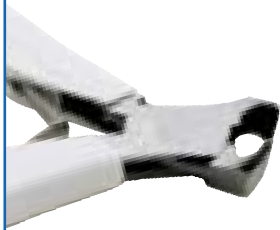

Product code	EAN code	A mm inch	B mm inch	C mm inch	G mm inch	Capacity mm inch	Bevel		
7293	0052592	108.0 4.25	8.0 0.31	10.5 0.41	8.0 0.31	0.35 - 1.0 0.01 - 0.04	Flush	56	1





Supreme Cutters and Pliers



MINIATURE END

Product code	EAN-code	A mm inch	B mm inch	C mm inch	D mm inch	E mm inch	F mm inch	Capacity mm inch	Bevel		
7292	0052578	115.0 4.53	15.0 0.59	9.0 0.35	6.0 0.24	3.2 0.13	4.0 0.16	0.35 - 0.8 0.01 - 0.03	Flush	54	1

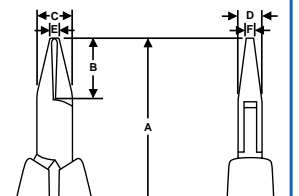
7292



PLIERS

Product code	EAN-code	A mm inch	B mm inch	C mm inch	D mm inch	E mm inch	F mm inch	Jaw shape		
7490	0052646	120.0 4.72	20.0 0.79	9.0 0.35	6.0 0.24	1.2 0.05	3.2 0.13	Smooth	53	1

FLAT NOSE

7490

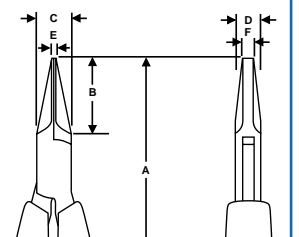





Supreme Cutters and Pliers

PLIERS

ROUND NOSE

7590



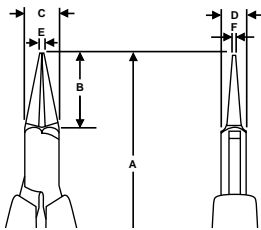

Product code	EAN code	A mm inch	B mm inch	C mm inch	D mm inch	E mm inch	F mm inch	Jaw shape	 g	
7590	0052660	120.0 4.72	20.0 0.79	9.0 0.35	6.0 0.24	1.0 0.04	Ø 0.5 Ø 0.02	Very fine	54	1



SNIPE NOSE

7890-7891



Product code	EAN code	A mm inch	B mm inch	C mm inch	D mm inch	E mm inch	F mm inch	Jaw shape	 g	
7890	0052691	132.0 5.20	32.0 1.26	9.0 0.35	6.0 0.24	1.2 0.05	0.8 0.03	Smooth	60	1
7891	0052714	132.0 5.20	32.0 1.26	9.0 0.35	6.0 0.24	1.2 0.05	0.8 0.03	Serrated	59	1

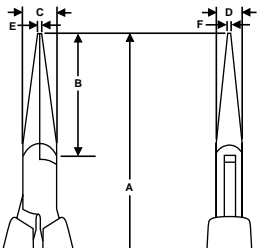





Supreme Cutters and Pliers

PLIERS

SNIPE NOSE WITH BENT TIP



Product code	EAN code	A mm inch	B mm inch	C mm inch	D mm inch	E mm inch	F mm inch	Jaw shape	 g	
7892	0052738	129.0 5.08	29.0 1.14	9.0 0.35	6.0 0.24	1.2 0.05	0.8 0.03	Smooth	59	1

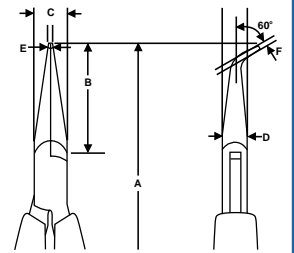
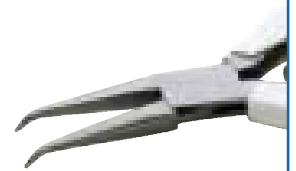

7892



SHORT SNIPE NOSE

Product code	EAN code	A mm inch	B mm inch	C mm inch	D mm inch	E mm inch	F mm inch	Jaw shape	 g	
7893	0052769	120.0 4.72	20.0 0.79	9.0 0.35	6.0 0.24	1.2 0.05	0.8 0.03	Smooth	56	1



7893

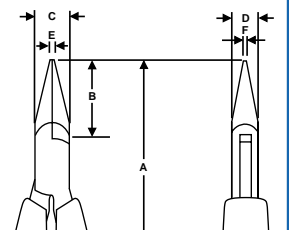





Multi-Purpose Shear

SHEAR ACTION CUTTERS

NEW

HS6000

Product code	EAN code	A mm inch	B mm inch	C mm inch	D mm inch	F mm inch	G mm		
HS6000	0113521	145.0 5.7	29.0 1.1	12.7 0.5	6.4 0.2	2.2 0.07	29.0 1.1	88	1

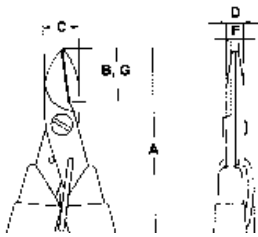





Tweezers



H I G H P R E C I S I O N

Product code	EAN code 731415+	L mm	L inch		
TL 00B-SA Strong tips and serrated grips.	0109555	120.0	4.72	21	1
TL 00D-SA Serrated tips and grips.	0109562	120.0	4.72	21	1
TL 00-SA Flat edge, strong tips.	0109579	120.0	4.72	22	1
TL 0C9-SA Flat edge, fine tips.	0109586	90.0	3.54	7	1
TL 0-SA Flat edge, fine tips.	0109593	120.0	4.72	14	1

 **TL 00B-SA**

 **TL 00D-SA**

 **TL 00-SA**

 **TL 0C9-SA**

 **TL 0-SA**



MATERIAL DESIGNATIONS

- SA** ESD-safe. Stainless, antimagnetic, anti-acid steel.
- TA** ESD-safe. Lightweight, high-temperature (1600F/870C) Titanium.
- CF** ESD-safe. High-temperature tolerant Carbon Fiber tips.

- NC** Plastic Coated.
- S** ESD-safe. Stainless.
- EP** ESD-safe. Epoxy.





Tweezers

HIGH PRECISION





 **TL 10G-SA**

Product code	EAN code	L mm	L inch	 g	
TL 10G-SA Serrated tips and grips.	0109609	110.0	4.33	13	1

 **TL 15A**

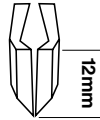
TL 15A Tapered cutting tips.	0109616	115.0	4.53	27	1
---------------------------------	---------	-------	------	----	---



 **TL 15AGW**

TL 15AGW Tapered cutting tips.	0109623	115.0	4.53	26	1
-----------------------------------	---------	-------	------	----	---

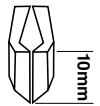

 **TL 15AP**

TL 15AP Parallel cutting tips.	0109630	115.0	4.53	27	1
-----------------------------------	---------	-------	------	----	---

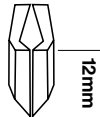



 **TL 1-SA**

TL 1-SA Strong, accurate tips.	0109647	120.0	4.72	13	1
-----------------------------------	---------	-------	------	----	---



Tweezers

HIGH PRECISION

Product code	EAN code 731415+	L mm	L inch		
TL 27-SA Strong, fine tips.	0109654	135.0	5.31	15	1
TL 2AB-SA Flat, curved, round tips.	0110094	120.0	4.72	15	1
TL 2A-SA Flat, round tips.	0110100	120.0	4.72	15	1
TL 2-SA Strong, sharp tips.	0110117	120.0	4.72	15	1
TL 34A-SA Rectangular tips and serrated grips.	0110124	120.0	4.72	15	1

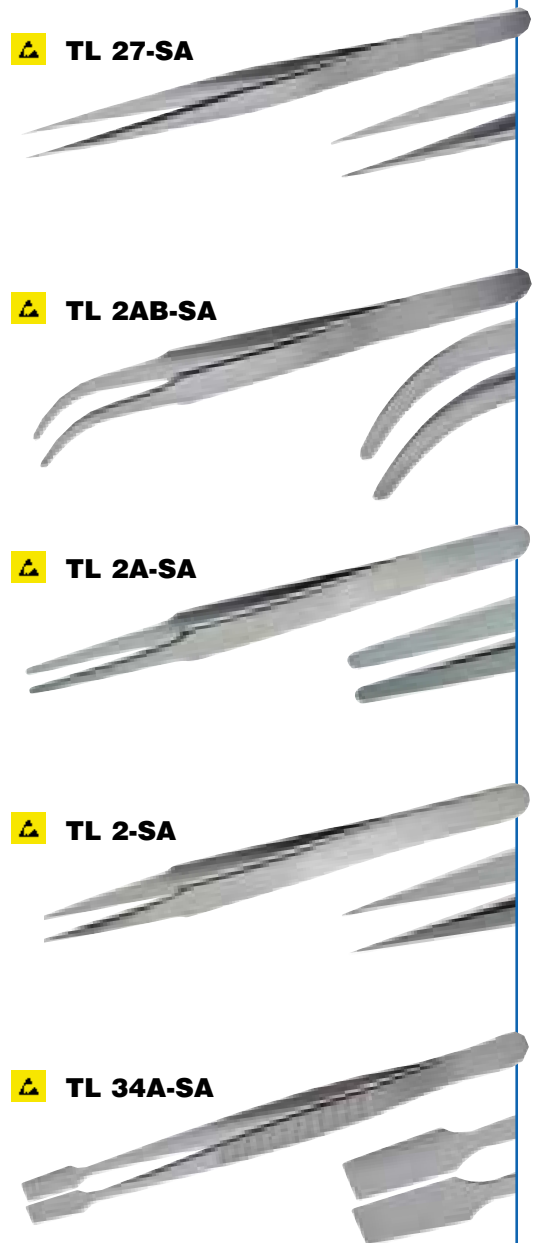

MATERIAL DESIGNATIONS

SA ESD-safe. Stainless, antimagnetic, anti-acid steel. **NC** Plastic Coated.
TA ESD-safe. Lightweight, high-temperature (1600F/870C) Titanium. **S** ESD-safe. Stainless.
CF ESD-safe. High-temperature tolerant Carbon Fiber tips. **EP** ESD-safe. Epoxy.





Tweezers

HIGH PRECISION



 **TL 35A-SA**

Product code	EAN code	L mm	L inch		
--------------	----------	------	--------	---	---

TL 35A-SA Smooth, fan-shape, serrated grips.	0110131	120.0	4.72	14	1
---	---------	-------	------	----	---



 **TL 3C-SA**

TL 3C-SA Very sharp tips.	0110148	110.0	4.33	12	1
-------------------------------------	---------	-------	------	----	---



 **TL 3C-TA**

TL 3C-TA Very sharp tips.	0110155	110.0	4.33	7	1
-------------------------------------	---------	-------	------	---	---



 **TL 3-SA**

TL 3-SA Very sharp tips.	0110162	120.0	4.72	13	1
------------------------------------	---------	-------	------	----	---





 **TL 3-TA**

TL 3-TA Very sharp tips.	0110179	120.0	4.72	9	1
------------------------------------	---------	-------	------	---	---



Tweezers

HIGH PRECISION

Product code	EAN code 731415+	L mm	L inch	 g	
TL 4-SA Extra fine tips.	0110186	110.0	4.33	13	1
TL 4A-SA Extra fine, strong tips.	0110193	110.0	4.33	13	1
TL 51S-SA Extra fine, double bent tips.	0110209	115.0	4.53	13	1
TL 5A-SA Extra fine tips.	0110216	115.0	4.53	13	1
TL 5B-SA Fine, bent tips.	0110223	110.0	4.33	13	1

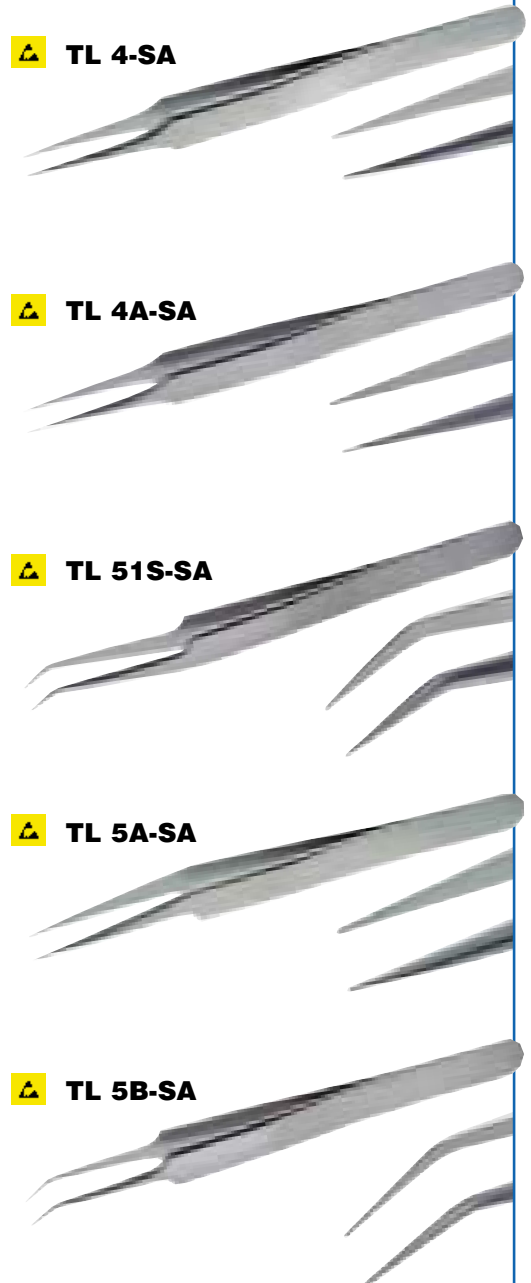

MATERIAL DESIGNATIONS

SA ESD-safe. Stainless, antimagnetic, anti-acid steel.	NC Plastic Coated.
TA ESD-safe. Lightweight, high-temperature (1600F/870C) Titanium.	S ESD-safe. Stainless.
CF ESD-safe. High-temperature tolerant Carbon Fiber tips.	EP ESD-safe. Epoxy.





Tweezers

HIGH PRECISION



 **TL 5C-SA**

Product code	EAN code	L mm	L inch	 g	
--------------	----------	------	--------	---	---

TL 5C-SA Fine, double bent tips.	0110230	115.0	4.53	13	1
--	---------	-------	------	----	---



 **TL 5-SA**

TL 5-SA Extra fine tips.	0110247	110.0	4.33	12	1
------------------------------------	---------	-------	------	----	---



 **TL 5-TA**

TL 5-TA Extra fine tips.	0110254	110.0	4.33	7	1
------------------------------------	---------	-------	------	---	---



 **TL 6-SA**

TL 6-SA Fine, angled tips.	0110261	115.0	4.53	15	1
--------------------------------------	---------	-------	------	----	---





 **TL 65A-SA**

TL 65A-SA Long, fine curved tips.	0110278	140.0	5.51	12	1
---	---------	-------	------	----	---



Tweezers

HIGH PRECISION

Product code	EAN code 731415+	L mm	L inch		
--------------	---------------------	---------	-----------	---	---

TL 7A-SA Strong, curved tips.	0110285	115.0	4.53	14	1
---	---------	-------	------	----	---

 **TL 7A-SA**

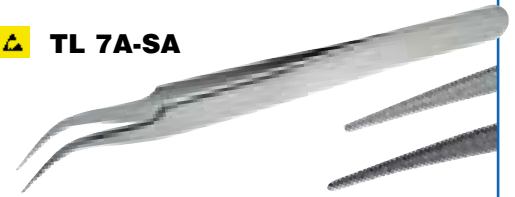

TL 7-SA Fine, curved tips.	0110292	115.0	4.53	13	1
--------------------------------------	---------	-------	------	----	---

 **TL 7-SA**

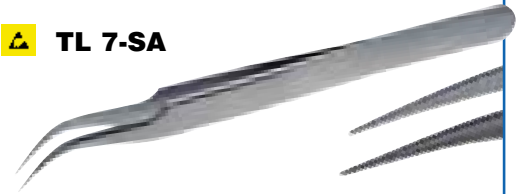

TL AC-SA Strong tips, serrated grips.	0110308	110.0	4.33	18	1
--	---------	-------	------	----	---

 **TL AC-SA**

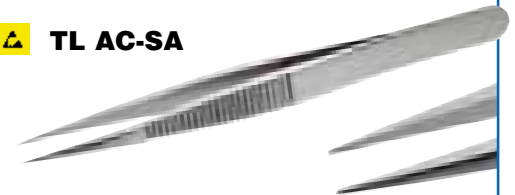

TL F-SA Flat, square-end tips.	0109883	120.0	4.72	15	1
---	---------	-------	------	----	---

 **TL F-SA**

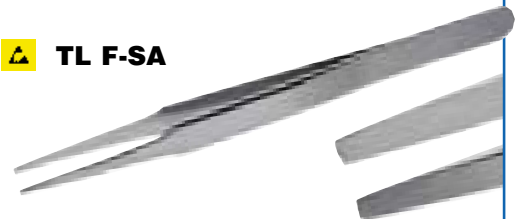

TL H-SA Dovetailed, fine tips.	0109890	90.0	3.54	12	1
---	---------	------	------	----	---

 **TL H-SA**

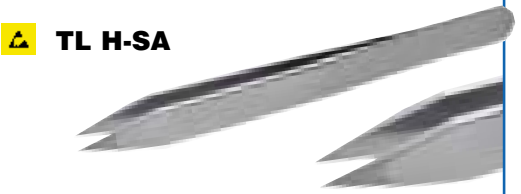

MATERIAL DESIGNATIONS

SA ESD-safe. Stainless, antimagnetic, anti-acid steel.

TA ESD-safe. Lightweight, high-temperature (1600F/870C) Titanium.

CF ESD-safe. High-temperature tolerant Carbon Fiber tips.

NC Plastic Coated.







S ESD-safe. Stainless.

EP ESD-safe. Epoxy.



Tweezers



HIGH PRECISION

 TL S-SA	Product code	EAN code 731415+	L mm	L inch	 g	
	TL S-SA Fine tips.	0109906	120.0	4.72	13	1
	TL SS-EP Slender, long, fine tips.	0109913	140.0	5.51	13	1
	TL SSG-SA Slender, long, strong tips.	0109920	140.0	5.51	17	1
	TL SS-SA Slender, long, fine tips.	0109937	140.0	5.51	12	1



Tweezers

GENERAL PURPOSE

Product code	EAN code 731415+	L mm	L inch		
TL 119A-SA Strong tips, serrated grips.	0109944	150.0	6.00	20	1
TL 119-SA Fine tips, serrated grips.	0109951	150.0	6.00	19	1
TL 120A-SA Short fine, sturdy tips, serrated grips.	0109968	110.0	4.33	10	1
TL 120-SA Strong tips, serrated grips.	0109975	150.0	6.00	25	1
TL 121-SA Strong, blunt tips, serrated grips.	0109982	160.0	6.30	26	1

 **TL 119A-SA**

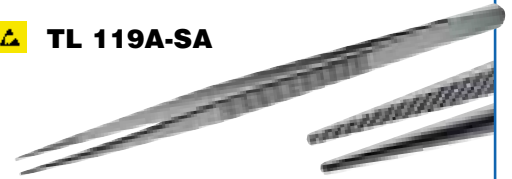

 **TL 119-SA**



 **TL 120A-SA**

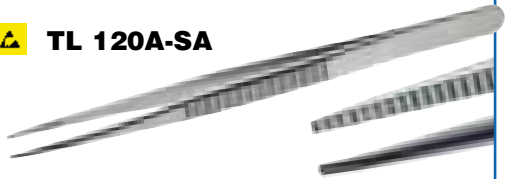

 **TL 120-SA**



 **TL 121-SA**



MATERIAL DESIGNATIONS

SA ESD-safe. Stainless, antimagnetic, anti-acid steel.
TA ESD-safe. Lightweight, high-temperature (1600F/870C) Titanium.
CF ESD-safe. High-temperature tolerant Carbon Fiber tips.

NC Plastic Coated.
S ESD-safe. Stainless.
EP ESD-safe. Epoxy.



Tweezers

GENERAL PURPOSE



TL 122-SA

Product code	EAN code	L mm	L inch	g	
731415+					
TL 122-SA Fine, bent tips and serrated grips.	0109999	150.0	6.00	19	1



TL 123-SA

TL 123-SA Fine, double bent tips and serrated grips.	0110001	150.0	6.00	19	1
--	---------	-------	------	----	---



TL 124-SA

TL 124-SA Fine, bent, strong tips and serrated grips.	0110018	150.0	6.00	20	1
---	---------	-------	------	----	---



REVERSE ACTION TWEEZER



TL 2AX-SA

TL 2AX-SA Reverse Action, style 2A.	0110025	120.0	4.72	15	1
---	---------	-------	------	----	---



Tweezers

HIGH STRENGTH GENERAL PURPOSE

Product code	EAN code 731415+	L mm	L inch		
TL 475-SA Blunt, serrated tips and grips.	0110032	140.0	5.51	25	1
TL 648-SA Fine, serrated tips and grips.	0110049	150.0	5.90	25	1
TL 648-NC Fine, serrated tips. Plastic coated.	0110971	150.0	5.90	25	1
TL 649-SA Fine, bent, serrated tips and grips.	0110063	150.0	5.90	25	1
TL 649-NC Fine, bent, serrated tips. Plastic coated.	0110964	150.0	5.90	25	1

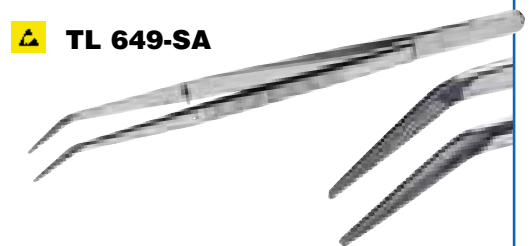
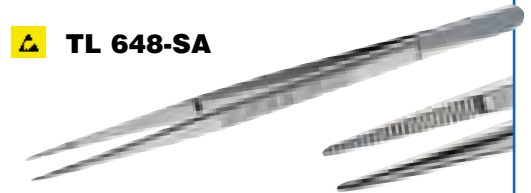

MATERIAL DESIGNATIONS

SA ESD-safe. Stainless, antimagnetic, anti-acid steel. **NC** Plastic Coated.
TA ESD-safe. Lightweight, high-temperature (1600F/870C) Titanium. **S** ESD-safe. Stainless.
CF ESD-safe. High-temperature tolerant Carbon Fiber tips. **EP** ESD-safe. Epoxy.





Tweezers

HIGH STRENGTH GENERAL PURPOSE





 **TL 231-SA**

Product code	EAN code	L mm	L inch	 g	
TL 231-SA	731415+				
TL 231-SA Strong, serrated tips.	0110087	120.0	4.72	14	1

STRONG BLUNT TIP



 **TL 7312-SA**

Product code	EAN code	L mm	L inch	 g	
TL 7312-SA	731415+				
TL 7312-SA Serrated tips and grips.	0110315	120.0	4.72	21	1



TL 7312-NC

TL 7312-NC Plastic coated serrated tips.	0110957	120.0	4.72	23	1
---	---------	-------	------	----	---

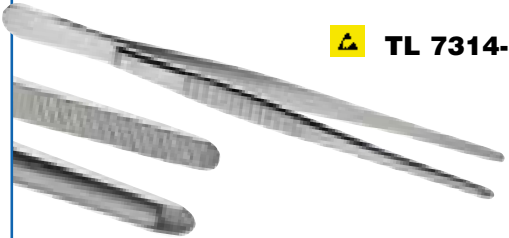



 **TL 7314-SA**

TL 7314-SA Serrated tips and grips.	0110339	140.0	5.51	31	1
--	---------	-------	------	----	---



Tweezers

BLUNT TIP

Product code	EAN code 731415+	L mm	L inch		
TL 7314-NC Plastic coated grips and serrated tips.	0110940	140.0	5.51	33	1
TL 7316-SA Serrated tips and grips.	0110360	160.0	6.30	33	1
TL 7316-NC Plastic coated grips and serrated tips.	0110933	160.0	6.30	33	1
TL 7320-SA Serrated tips and grips.	0110377	200.0	7.87	50	1
TL 7320-NC Plastic coated grips and serrated tips.	0110926	200.0	7.87	55	1

TL 7314-NC



 **TL 7316-SA**



TL 7316-NC



 **TL 7320-SA**



TL 7320-NC



MATERIAL DESIGNATIONS

- SA** ESD-safe. Stainless, antimagnetic, anti-acid steel.
- TA** ESD-safe. Lightweight, high-temperature (1600F/870C) Titanium.
- CF** ESD-safe. High-temperature tolerant Carbon Fiber tips.

- NC** Plastic Coated.
- S** ESD-safe. Stainless.
- EP** ESD-safe. Epoxy.





Tweezers

COMPONENT HANDLING



TL 571-SA

Product code	EAN code	L mm	L inch		
--------------	----------	------	--------	---	---

TL 571-SA	0110391	145.0	5.71	25	1
<i>Straight tips, Ø 6 mm, components 2.5–5.0 mm and serrated grips.</i>					



TL 572-SA

TL 572-SA	0110407	145.0	5.71	26	1
<i>Angled tips 90°, Ø 6 mm, components 2.5–5.0 mm and serrated grips.</i>					



TL 573-SA

TL 573-SA	0110414	145.0	5.71	25	1
<i>Angled tips 45°, Ø 6 mm, components 2.5–5.0 mm and serrated grips.</i>					



TL 577-SA

TL 577-SA	0110421	115.0	4.53	13	1
<i>Straight tips, Ø 4 mm, components 2.0 mm and serrated grips.</i>					





TL 578-SA

TL 578-SA	0110438	115.0	4.53	15	1
<i>Angled tips 90°, Ø 4 mm, components 2.0 mm and serrated grips.</i>					



Tweezers

COMPONENT HANDLING

Product code	EAN code 731415+	L mm	L inch		
TL 579-SA <i>Angled tips 45°, Ø 4 mm, components 2.0 mm and serrated grips.</i>	0110445	115.0	4.53	15	1
TL 582-SA <i>Angled tips 90°, Ø 4 mm, components 1.0 mm and serrated grips.</i>	0110452	115.0	4.53	15	1
TL 58A-SA <i>For round components, TO-5.</i>	0110469	115.0	4.53	15	1
TL 29D-SA <i>Soldering tweezer, reverse action. Angled.</i>	0110476	150.0	5.90	32	1
TL 30-SA <i>Soldering tweezer, reverse action. Bent.</i>	0110483	165.0	6.50	32	1

 **TL 579-SA**



 **TL 582-SA**



 **TL 58A-SA**

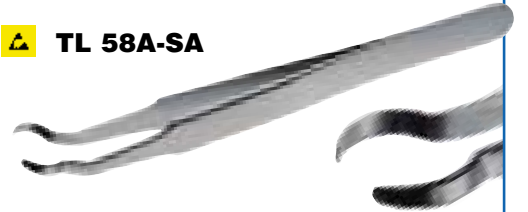

TL 29D-SA



TL 30-SA



MATERIAL DESIGNATIONS

SA ESD-safe. Stainless, antimagnetic, anti-acid steel.

TA ESD-safe. Lightweight, high-temperature (1600F/870C) Titanium.

CF ESD-safe. High-temperature tolerant Carbon Fiber tips.

NC Plastic Coated.

S ESD-safe. Stainless.

EP ESD-safe. Epoxy.



Tweezers



COMPONENT HANDLING

 TL 31-SA	Product code	EAN code 731415+	L mm	L inch	 g	
	TL 31-SA	0110490	120.0	4.72	12	1
<i>Soldering tweezers, reverse action, straight, fine tips.</i>						
 TL 574B-SA	Product code	EAN code	L mm	L inch	 g	
	TL 574B-SA	0110506	145.0	5.71	25	1
						
<i>Soldering tweezers, angled tips and serrated grips.</i>						
 TL 574-SA	Product code	EAN code	L mm	L inch	 g	
	TL 574-SA	0110513	145.0	5.71	26	1
						
<i>Flat straight tips and serrated grips.</i>						
 TL 574-SAC	Product code	EAN code	L mm	L inch	 g	
	TL 574-SAC	0110520	145.0	5.71	30	1
						
<i>Straight plastic coated tips and serrated grips.</i>						
 TL 574-SA Cu	Product code	EAN code	L mm	L inch	 g	
	TL 574-SA Cu	0110537	145.0	5.71	23	1
						
<i>Straight copper-cooling tips and serrated grips.</i>						



Tweezers

BOLEY STYLE

Product code	EAN code 731415+	L mm	L inch		
TL AA-S <i>Strong, fine tips.</i>	0110544	130.0	5.12	16	1
TL AA-SA <i>Strong, fine tips.</i>	0110551	130.0	5.12	17	1
TL AA-SAC <i>Strong, fine tips. Plastic coated.</i>	0110568	130.0	5.12	22	1
TL AA-TA <i>Strong, fine tips.</i>	0110575	130.0	5.12	10	1
TL GG-SA <i>Straight, fine tips.</i>	0110582	130.0	5.12	17	1

 **TL AA-S**

 **TL AA-SA**

TL AA-SAC

 **TL AA-TA**

 **TL GG-SA**

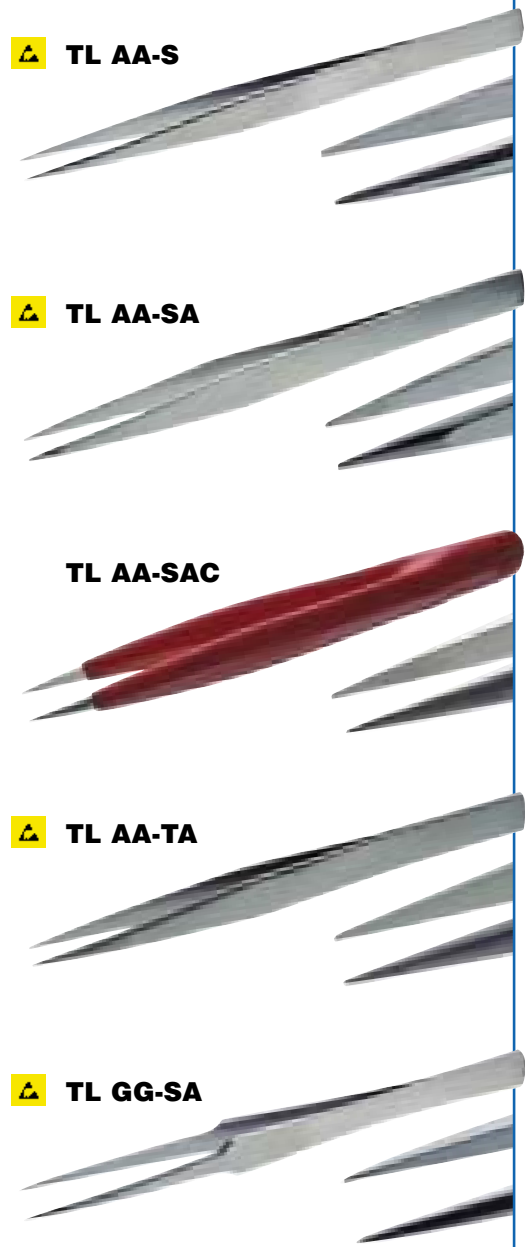

MATERIAL DESIGNATIONS

SA ESD-safe. Stainless, antimagnetic, anti-acid steel.
TA ESD-safe. Lightweight, high-temperature (1600F/870C) Titanium.
CF ESD-safe. High-temperature tolerant Carbon Fiber tips.

NC Plastic Coated.
S ESD-safe. Stainless.
EP ESD-safe. Epoxy.



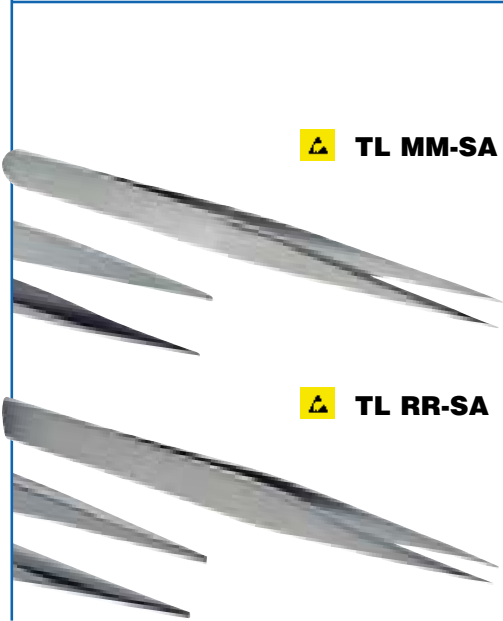

Tweezers

BOLEY STYLE



 **TL MM-SA**

Product code	EAN code 731415+	L mm	L inch	 g	
TL MM-SA <i>Strong tips.</i>	0110599	130.0	5.12	15	1



 **TL RR-SA**

TL RR-SA <i>Strong, fine tips.</i>	0110605	145.0	5.71	27	1
--	---------	-------	------	----	---

FIBER TIP



 **TL 248CF-SA**

Product code	EAN code 731415+	L mm	L inch	 g	
TL 248CF-SA <i>Carbon fiber tips.</i>	0110612	125.0	4.92	32	1



 **TL 249CF-SA**

TL 249CF-SA <i>Carbon fiber tips. Style 00.</i>	0110629	130.0	5.12	17	1
---	---------	-------	------	----	---



Tweezers

FIBER TIP

Product code	EAN code 731415+	L mm	L inch		
TL 250CF-SA <i>Carbon fiber tips.</i>	0110636	125.0	4.92	32	1
TL 251-SA <i>Carbon fiber tips.</i>	0110643	110.0	4.33	17	1
TL 252-SA <i>Carbon fiber tips.</i>	0110650	110.0	4.33	17	1
TL 253-SA <i>Carbon fiber tips.</i>	0110667	110.0	4.33	17	1
TL 254-SA <i>Carbon fiber tips.</i>	0110674	110.0	4.33	18	1



MATERIAL DESIGNATIONS

SA ESD-safe. Stainless, antimagnetic, anti-acid steel. **NC** Plastic Coated.
TA ESD-safe. Lightweight, high-temperature (1600F/870C) Titanium. **S** ESD-safe. Stainless.
CF ESD-safe. High-temperature tolerant Carbon Fiber tips. **EP** ESD-safe. Epoxy.



Tweezers



FIBER TIP

 TL 255-SA	Product code	EAN code 731415+	L mm	L inch	 g	
	TL 255-SA	0110681	110.0	4.33	11	1
	<i>Carbon fiber tips.</i>					
	TL 256-SA	0110698	110.0	4.33	11	1
	<i>Carbon fiber tips.</i>					
	TL 257-SA	0110704	110.0	4.33	11	1
	<i>Carbon fiber tips.</i>					
	TL 259CF-SA	0110728	130.0	5.12	17	1
	<i>Carbon fiber tips.</i>					
	TL 269CF-SA	0110735	130.0	5.12	16	1
	<i>Carbon fiber tips. Style 2A.</i>					



Tweezers

S M D

Product code	EAN code 731415+	L mm	L inch		
TL SM100-SA <i>Reverse action, for handling SMDs.</i>	0110742	115.0	4.53	13	1
TL SM101-SA <i>Reverse action, for soldering and desoldering 8, 14, 16 lead SMDs.</i>	0110759	115.0	4.53	12	1
TL SM102-SA <i>Reverse action, for soldering and desoldering 20, 28, 44, 68 LCCC and PLCC pad devices.</i>	0110766	115.0	4.53	12	1
TL SM103-SA <i>Handling and positioning 2 and 3 lead SOT packages at 45° angle.</i>	0110773	115.0	4.53	15	1
TL SM104-SA <i>Handling and positioning 3 lead SOT packages.</i>	0110780	120.0	4.72	15	1

 **TL SM100-SA**



 **TL SM101-SA**



 **TL SM102-SA**



 **TL SM103-SA**



 **TL SM104-SA**



MATERIAL DESIGNATIONS

SA ESD-safe. Stainless, antimagnetic, anti-acid steel.
TA ESD-safe. Lightweight, high-temperature (1600F/870C) Titanium.
CF ESD-safe. High-temperature tolerant Carbon Fiber tips.

NC Plastic Coated.
S ESD-safe. Stainless.
EP ESD-safe. Epoxy.





Tweezers

S M D



 **TL SM105-SA**

Product code	EAN code	L mm	L inch		
	731415+				

TL SM105-SA	0110797	120.0	4.72	15	1
<i>For all vertical SOT packages.</i>					



 **TL SM106-SA**

TL SM106-SA	0110803	120.0	4.72	15	1
<i>For all horizontal SOT packages.</i>					



 **TL SM107-SA**

TL SM107-SA	0110810	120.0	4.72	15	1
<i>For positioning flat devices at 60° angle.</i>					



 **TL SM108-SA**

TL SM108-SA	0110827	120.0	4.72	15	1
<i>Grooved tips for positioning and soldering, 1 mm comp.</i>					



 **TL SM109-SA**

TL SM109-SA	0110834	120.0	4.72	15	1
<i>Grooved tips, 45° angle. See TL SM108-SA.</i>					



Tweezers

S M D

Product code	EAN code 731415+	L mm	L inch		
TL SM110-SA <i>Grooved tips for positioning monolithic chip capacitors.</i>	0110841	120.0	4.72	15	1
TL SM111-SA <i>Grooved tips for positioning 5 mm monolithic chip capacitors.</i>	0110858	120.0	4.72	15	1
TL SM112-SA <i>Grooved tips. 60° angle. See TL SM111-SA.</i>	0110865	120.0	4.72	15	1
TL SM113-SA <i>3 mm long tips, bent at 60° angle.</i>	0110872	120.0	4.72	15	1
TL SM114-SA <i>Straight tips vertical. See TL SM113-SA.</i>	0110889	120.0	4.72	15	1

 **TL SM110-SA**

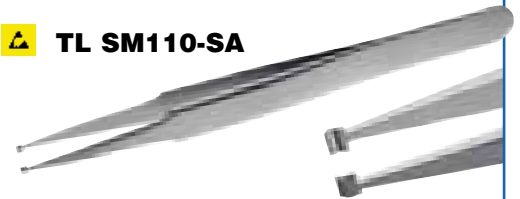

 **TL SM111-SA**



 **TL SM112-SA**



 **TL SM113-SA**



 **TL SM114-SA**



MATERIAL DESIGNATIONS

SA ESD-safe. Stainless, antimagnetic, anti-acid steel.

TA ESD-safe. Lightweight, high-temperature (1600F/870C) Titanium.

CF ESD-safe. High-temperature tolerant Carbon Fiber tips.

NC Plastic Coated.

S ESD-safe. Stainless.

EP ESD-safe. Epoxy.



Tweezers

S M D



TL SM115-SA

Product code	EAN code	L mm	L inch	g	
	731415+				

TL SM115-SA	0110896	120.0	4.72	15	1
--------------------	---------	-------	------	----	---

Grooved tips, 30° angle.



TL SM116-SA

TL SM116-SA	0110902	120.0	4.72	14	1
--------------------	---------	-------	------	----	---

Grooved tips, vertical, positioning of cylindrical devices Ø 1 mm or more.



TL SM117-SA

TL SM117-SA	0110919	120.0	4.72	15	1
--------------------	---------	-------	------	----	---

For positioning SOT devices at 30° angle.

MATERIAL DESIGNATIONS

SA ESD-safe. Stainless, antimagnetic, anti-acid steel.

TA ESD-safe. Lightweight, high-temperature (1600F/870C) Titanium.

CF ESD-safe. High-temperature tolerant Carbon Fiber tips.

NC Plastic Coated.

S ESD-safe. Stainless.

EP ESD-safe. Epoxy.



Tweezers Sets

FINE TIP

Product code	EAN code 731415+	Part No.	A mm inch	B mm inch	C mm inch	 g	
--------------	---------------------	----------	-----------------	-----------------	-----------------	--	---

NEW

9858

9858	0111862	TL AA-SA <i>Strong fine tips.</i> TL SS-SA <i>Slender, long and fine tips.</i>	200.0 7.87	65.0 2.57	8.0 0.31	60 2.12	1
-------------	---------	---	---------------	--------------	-------------	------------	---

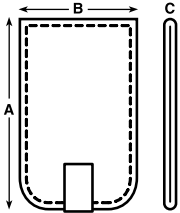

STRONG TIP

Product code	EAN code 731415+	Part No.	A mm inch	B mm inch	C mm inch	 g	
--------------	---------------------	----------	-----------------	-----------------	-----------------	--	---

NEW

9859

9859	0113057	TL 00B-SA <i>Strong tips and serrated grips.</i> TL 2A-SA <i>Flat profile with round tips.</i>	200.0 7.87	65.0 2.57	8.0 0.31	75 2.12	1
-------------	---------	---	---------------	--------------	-------------	------------	---

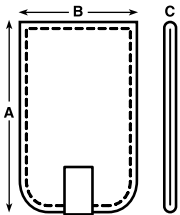



Tweezers Sets

TITANIUM

NEW

9856

Product code	EAN code 731415+	Part No.	A mm inch	B mm inch	C mm inch		
--------------	---------------------	----------	-----------------	-----------------	-----------------	--	--



9856	0111855	TL 3C-TA <i>Very sharp tips.</i> TL 3-TA <i>Very fine, sharp tips.</i> TL 5-TA <i>Extra fine tips.</i> TL AA-TA <i>Strong fine tips.</i>	200.0 7.87	110.0 4.33	10.0 0.39	75 2.65	1
-------------	---------	---	---------------	---------------	--------------	------------	---

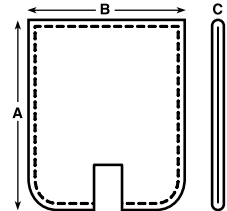

HIGH PRECISION

NEW

9857

Product code	EAN code 731415+	Part No.	A mm inch	B mm inch	C mm inch		
--------------	---------------------	----------	-----------------	-----------------	-----------------	--	--



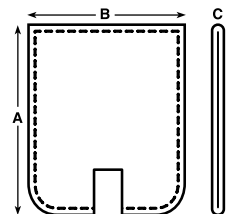

9857	0114283	TL 00-SA <i>Flat edge, strong tips.</i> TL 1-SA <i>Strong, sharp tips.</i> TL 3C-SA <i>Very sharp tips.</i> TL 5-SA <i>Extra fine tips.</i> TL 7-SA <i>Fine, curved tips.</i>	200.0 7.87	110.0 4.33	10.0 0.39	115 4.06	1
-------------	---------	--	---------------	---------------	--------------	-------------	---







Tweezers Sets

HIGH PRECISION

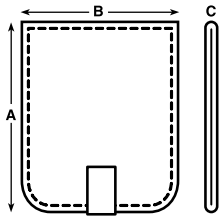
Product code	EAN code 731415+	Part No.	A mm inch	B mm inch	C mm inch			NEW 9855
9855	0111848	TL SS-SA <i>Slender, long and fine tips.</i> TL AA-SA <i>Strong fine tips.</i> TL 2A-SA <i>Flat round tips.</i> TL 4A-SA <i>Extra fine tips.</i> TL 7A-SA <i>Strong curved tips.</i>	200.0 7.87	110.0 4.33	10.0 0.39	115 4.06	1	



S M D

Product code	EAN code 731415+	Part No.	A mm inch	B mm inch	C mm inch			NEW 9854
9854	0111831	TL 5C-SA <i>Fine, double-bent tips.</i> TL 5-SA <i>Extra fine tips.</i> TL SM 101-SA <i>Reverse action.</i> <i>Soldering and desoldering 8, 14 or 16 leads SMDs.</i> TL SM 102-SA <i>Reverse action.</i> <i>Soldering and desoldering 20, 28, 44 and 68 LCCC and PLCC pad devices.</i> TL SM 107-SA <i>For positioning flat devices at 60° angle.</i> TL SM 108-SA <i>Grooved tips for positioning and soldering 1 mm wide components.</i> TL SM 115-SA <i>Grooved tips, 30° angle.</i>	200.0 7.87	180.0 7.09	20.0 0.78	140 4.94	1	

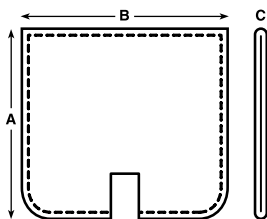



Torque Screwdrivers

TORQUE

NEW

MA500



Product code	EAN code 731415+	A mm inch	B mm inch	C mm inch	D mm inch	⌀ inch	Capacity Ncm		
MA500-1	112395	138.0 5.43	18.2 0.72	28.0 1.10	9.6 0.38	1/4	10 - 80	195	1
MA500-2	112401	157.0 6.18	18.2 0.72	28.0 1.10	9.6 0.38	1/4	40 - 200	260	1
MA500-3	112418	171.0 6.73	18.2 0.72	32.0 1.26	9.6 0.38	1/4	50 - 450	306	1

Store driver in the protective case at lowest torque setting.
Do not force adjusting knob below lowest setting.

NEW

MAL500



Product code	EAN code 731415+	A mm inch	B mm inch	C mm inch	D mm inch	⌀ inch	Capacity in. ozs./in. lbs		
MAL500-1	112593	138.0 5.43	18.2 0.72	28.0 1.10	9.6 0.38	1/4	20 - 100 in.ozs	195	1
MAL500-2	112609	157.0 6.18	18.2 0.72	28.0 1.10	9.6 0.38	1/4	3 - 15 in.lbs	260	1
MAL500-3	112616	171.0 6.73	18.2 0.72	32.0 1.26	9.6 0.38	1/4	5 - 40 in.lbs	306	1

Store driver in the protective case at lowest torque setting.
Do not force adjusting knob below lowest setting.

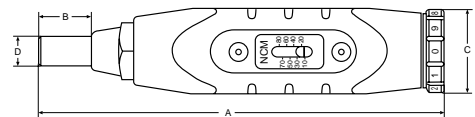

NEW

PS501



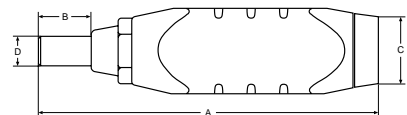

Product code	EAN code 731415+	A mm inch	B mm inch	C mm inch	D mm inch	⌀ inch	Capacity Ncm in. ozs./in. lbs		
PS501-1	0112425	115.0 4.53	18.2 0.72	28.0 1.10	9.6 0.38	1/4	4 - 22 6 - 32 in.ozs	147	1
PS501-2	0112432	141.0 5.55	18.2 0.72	28.0 1.10	9.6 0.38	1/4	7 - 70 10 - 100 in.ozs	187	1
PS501-3	0112449	141.0 5.55	18.2 0.72	28.0 1.10	9.6 0.38	1/4	15 - 170 1.5 - 15 in.lbs	198	1
PS501-4	0112456	154.0 6.06	18.2 0.72	32.0 1.26	9.6 0.38	1/4	45 - 450 4 - 40 in.lbs	270	1





Torque Screwdrivers

S E T S

Product code	EAN code	Contents	A mm inch	B mm inch	C mm inch		
TSK505	0114160	59/S28-1 bit box 6961 1/4" extension 6972H non magnetic bit holder	257 10.3	200 8.0	45 1.8	548	1

NEW

TSK505



Bit Box contents

K6729	Hexagon male 1/4" to 1/4" square male	1
KM653	Magnetic bitholder	1
Slotted	0.6x4.5mm/0.02x0.17	1
	0.8x5.5mm/0.03x0.21	1
	1.2x6.5mm/0.05x0.26	1
Phillips®	0	2
	1	2
	2	2
Pozidriv®	0	1
	1	1
	2	1
Torx®	T6	1
	T7	1
	T8	1
	T9	1
	T10	1
	T15	1
	T20	1
	T25	1
	T27	1
	Hexagon	55M-1.5
55M-2.0		1
55M-2.5		1
55M-3.0		1
55M-4.0		1

Ideal for field service work, the TSK505 Bit Box contains a comprehensive selection of bits for use with Lindstrom's torque screwdrivers.

A compartment is provided with space for one screwdriver. Note: Screwdriver must be ordered separately. See page 88.





Screwdrivers



SLOTTED
DIN 5265
ISO 2380-2
Tip DIN 5264-A,
ISO 2380-1.



PHILLIPS® PH
DIN 5262,
ISO 8764-2
Tip DIN 5260,
ISO 8764-1.



POZIDRIV® Pz
DIN 5262,
ISO 8764-2.
Tip DIN 5260,
ISO 8764-1.



TORX®



HEXAGON



SLOTTED



NEW

BE-8010 - BE-8255

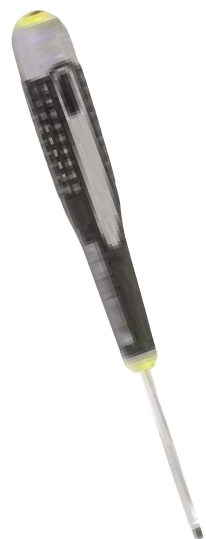

Product code	EAN code 731415+	mm		inch		mm		inch		Scales	Packaging
		mm	inch	mm	inch	mm	inch	mm	inch		
BE-8010	0010615	0.4	2.5	50.0	16.0 x 102.0	152.0	17	5			
		0.01	0.09	1.96	0.63 x 4.02	5.98					
BE-8020	0010639	0.5	3.0	50.0	16.0 x 102.0	152.0	20	5			
		0.02	0.11	1.96	0.63 x 4.02	5.98					
BE-8020L	1838591	0.5	3.0	75.0	16.0 x 102.0	177.0	22	5			
		0.020	0.11	2.95	0.63 x 4.02	7.0					
BE-8030	0010653	0.6	3.5	75.0	20.0 x 122.0	197.0	35	5			
		0.02	0.13	2.95	0.79 x 4.80	7.76					
BE-8040	0010677	0.8	4.0	100.0	20.0 x 122.0	222.0	38	5			
		0.03	0.15	3.93	0.79 x 4.80	8.75					
BE-8150	0010707	1.0	5.5	100.0	27.0 x 122.0	222.0	70	5			
		0.039	0.21	3.92	1.06 x 4.80	8.75					
BE-8155	0010721	1.2	6.5	125.0	36.0 x 122.0	247.0	101	5			
		0.05	0.26	4.92	1.42 x 4.80	9.72					
BE-8210	1838584	0.4	2.5	75.0	16.0 x 102.0	177.0	18	5			
		0.01	0.09	2.95	0.63 x 4.0	7.0					
BE-8220	0047741	0.5	3.0	125.0	16.0 x 102.0	227.0	22	5			
		0.020	0.11	4.92	0.63 x 4.0	9.0					
BE-8230	0047758	0.6	3.5	125.0	20.0 x 122.0	247.0	38	5			
		0.024	0.13	4.92	0.79 x 4.80	9.72					
BE-8240	0047765	0.8	4.0	175.0	20.0 x 122.0	297.0	47	5			
		0.03	0.15	6.89	0.79 x 4.80	11.69					
BE-8250	0047772	1.0	5.5	150.0	27.0 x 122.0	272.0	75	5			
		0.039	0.21	5.90	1.06 x 4.80	10.70					
BE-8250L	1838607	1.0	5.5	200.0	27.0 x 122.0	322.0	90	5			
		0.039	0.21	7.87	1.06 x 4.80	12.67					
BE-8255	0047789	1.2	6.5	150.0	36.0 x 122.0	272.0	114	5			
		0.05	0.26	5.90	1.42 x 4.80	10.70					



Screwdrivers

S L O T T E D W I T H H E X A G O N C O L L A R



Product code	EAN code 731415+								
		mm inch	mm inch	mm inch					
BE-8160	0010745	1.2 0.05	8 0.31	125 4.92	36.0 x 122.0 1.42 x 4.80	247.0 9.72	11.0 0.43	142	5
BE-8260	0047796	1.2 0.05	8 0.31	175 6.88	36.0 x 122.0 1.42 x 4.80	297.0 11.69	11.0 0.43	165	5
BE-8865	0010851	1.6 0.06	8 0.31	175 6.88	36.0 x 161.0 1.42 x 6.33	336.0 13.25	13.0 0.51	176	5
BE-8870	0010875	1.6 0.06	10 0.39	175 6.88	36.0 x 161.0 1.42 x 6.33	336.0 13.25	13.0 0.51	200	5
BE-8880	0010899	2 0.08	12 0.47	200 7.86	36.0 x 161.0 1.42 x 6.33	361.0 14.20	13.0 0.51	272	5
BE-8890	0010905	2.5 0.09	14 0.55	200 7.86	36.0 x 161.0 1.42 x 6.33	361.0 14.20	16.0 0.63	276	5

NEW
BE-8160 - BE-8890



S L O T T E D S T U B B Y T Y P E



Product code	EAN code 731415+								
		mm	mm	mm					
BE-8330	1838614	0.6 0.02	3.5 0.13	25.0 0.98	36.0 x 58.0 1.42 x 2.28	83.0 3.26		43	5
BE-8340	1838621	0.8 0.03	4.0 0.15	25.0 0.98	36.0 x 58.0 1.42 x 2.28	83.0 3.26		43	5
BE-8350	1838638	1.0 0.04	5.5 0.21	25.0 0.98	36.0 x 58.0 1.42 x 2.28	83.0 3.26		43	5
BE-8355	1838652	1.2 0.05	6.5 0.26	25.0 0.98	36.0 x 58.0 1.42 x 2.28	83.0 3.26		43	5
BE-8360	1838676	1.2 0.05	8.0 0.31	25.0 0.98	36.0 x 58.0 1.42 x 2.28	83.0 3.26		50	5
BE-8450	1838645	1.0 0.04	5.5 0.21	45.0 1.77	36.0 x 58.0 1.42 x 2.28	103.0 4.05		51	5
BE-8455	1838669	1.2 0.05	6.5 0.26	45.0 1.77	36.0 x 58.0 1.42 x 2.28	103.0 4.05		25	5

NEW
BE-8330 - BE-8455





Screwdrivers

PHILLIPS® PH



NEW

BE-8600 - BE-8620L



Product code	EAN code 731415+	 mm inch	 mm inch	 mm inch		 g	
BE-8600	0010769	60.0 2.36	16.0 x 102.0 0.63 x 4.02	162.0 6.38	0 0	19	5
BE-8610	0010776	75.0 2.95	20.0 x 122.0 0.79 x 4.80	197.0 7.75	1 1	46	5
BE-8610L	1838683	200.0 7.87	20.0 x 122.0 0.79 x 4.80	322.0 12.67	1 1	75	5
BE-8620	0010783	100.0 3.94	27.0 x 122.0 1.06 x 4.80	222.0 8.74	2 2	72	5
BE-8620L	1838690	200.0 7.87	27.0 x 122.0 1.06 x 4.80	322.0 12.67	2 2	85	5

PHILLIPS® PH WITH HEXAGON COLLAR



BE-8630 - BE-8640









Product code	EAN code 731415+	 mm inch	 mm inch	 mm inch	 mm inch		 g	
BE-8630	0010790	150.0 5.90	36.0 x 122.0 1.42 x 4.80	272.0 10.71	11.0 0.43	3 3	154	5
BE-8640	0010806	200.0 7.87	36.0 x 161.0 1.42 x 6.34	361.0 14.21	16.0 0.63	4 4	222	5



Screwdrivers

PHILLIPS® PH STUBBY TYPE



Product code	EAN code 731415+	 mm	 mm	 mm		 g	
BE-8601	1838706	25.0 0.98	36.0 x 58.0 1.42 x 2.28	83.0 3.26	1 1	40	5
BE-8602	1838713	25.0 0.98	36.0 x 58.0 1.42 x 2.28	83.0 3.26	2 2	45	5







NEW

BE-8601 - BE-8602



POZIDRIV® PZ



Product code	EAN code 731415+	 mm inch	 mm inch	 mm inch		 g	
BE-8800	0042012	60.0 2.36	16.0 x 102.0 0.63 x 4.02	162.0 6.34	0 0	19	5
BE-8810	0010813	75.0 2.95	20.0 x 122.0 0.79 x 4.80	197.0 7.76	1 1	40	5
BE-8810L	1838720	200.0 7.86	20.0 x 122.0 0.79 x 4.80	322.0 12.67	1 1	75	5
BE-8820	0010820	100.0 3.94	27.0 x 122.0 1.06 x 4.80	222.0 8.74	2 2	72	5
BE-8820L	1838737	200.0 7.86	27.0 x 122.0 1.06 x 4.80	322.0 12.67	2 2	85	5

NEW

BE-8800 - BE-8820L





Screwdrivers

POZIDRIV® PZ WITH HEXAGON COLLAR



BE-8830 - BE-8840



Product code	EAN code 731415+	 mm inch	 mm inch	 mm inch	 mm inch	 3 3	 g	
BE-8830	0010837	150.0 5.90	36.0 x 122.0 1.41 x 4.80	272.0 10.71	11.0 0.43	3 3	136	5
BE-8840	0010844	200.0 7.87	36.0 x 161.0 1.41 x 6.34	361.0 14.21	16.0 0.63	4 4	222	5

POZIDRIV® PZ STUBBY TYPE



NEW

BE-8801 - BE-8802









Product code	EAN code 731415+	 mm inch	 mm inch	 mm inch	 mm inch	 1 1 2 2	 g	
BE-8801	1838744	25.0 0.98	36.0 x 58.0 1.42 x 2.28	83.0 3.26		1 1	45	5
BE-8802	1838751	25.0 0.98	36.0 x 58.0 1.42 x 2.28	83.0 3.26		2 2	53	5



Screwdrivers







TORX®



Product code	EAN code 731415+	 mm inch	 mm inch	 mm inch	 mm inch			
BE-8906	0027729	50.0 1.97	16.0 x 102.0 0.63 x 4.02	152.0 5.98	1.70 0.07	T6	15	5
BE-8907	0027736	55.0 2.16	16.0 x 102.0 0.63 x 4.02	157.0 6.18	1.99 0.08	T7	22	5
BE-8908	0027743	60.0 2.36	16.0 x 102.0 0.63 x 4.02	162.0 6.38	2.31 0.09	T8	23	5
BE-8909	0027750	60.0 2.36	20.0 x 122.0 0.79 x 4.80	182.0 7.16	2.50 0.10	T9	41	5
BE-8910	0027767	65.0 2.56	20.0 x 122.0 0.79 x 4.80	187.0 7.36	2.74 0.11	T10	34	5
BE-8915	0027774	70.0 2.75	20.0 x 122.0 0.79 x 4.80	192.0 7.56	3.27 0.13	T15	35	5
BE-8920	0027781	80.0 3.15	27.0 x 122.0 1.06 x 4.80	202.0 7.95	3.86 0.15	T20	60	5
BE-8925	0027798	80.0 3.15	27.0 x 122.0 1.06 x 4.80	202.0 7.95	4.43 0.17	T25	55	5
BE-8927	0027804	100.0 3.94	36.0 x 122.0 1.42 x 4.80	222.0 8.74	4.99 0.20	T27	96	5
BE-8930	0027811	100.0 3.94	36.0 x 122.0 1.42 x 4.80	222.0 8.74	5.52 0.22	T30	96	5

BE-8906 - BE-8930



Product code	EAN code 731415+	 mm inch	 mm inch	 mm inch	 mm inch			
BE-8940	0027828	130.0 5.12	36.0 x 161.0 1.42 x 6.34	291.0 11.46	6.65 0.26	T40	163	5
BE-8945	1838782	130.0 5.12	36.0 x 161.0 1.42 x 6.34	291.0 11.46	7.82 0.31	T45	163	5

NEW

BE-8940 - BE-8945





Screwdrivers

HEXAGON SOCKET



NEW

BE-8702 - BE-8708



Product code	EAN code 731415+	 mm inch	 mm inch	 mm inch		 g	
BE-8702	1838768	110.0 4.33	16.0 x 102.0 0.63 x 4.02	212.0 8.35	2 2	22	5
BE-8725	1838775	110.0 4.33	17.0 x 102.0 0.67 x 4.02	212.0 8.35	2.5 2.5	22	5
BE-8703	0027651	110.0 4.33	16.0 x 102.0 0.63 x 4.02	212.0 8.35	3 3	25	5
BE-8704	0027668	110.0 4.33	20.0 x 122.0 0.79 x 4.80	232.0 9.13	4 4	41	5
BE-8705	0027675	110.0 4.33	27.0 x 122.0 1.06 x 4.80	232.0 9.13	5 5	65	5
BE-8706	0027682	140.0 5.51	27.0 x 122.0 1.06 x 4.80	262.0 10.31	6 6	97	5
BE-8708	0027699	150.0 5.90	36.0 x 122.0 1.42 x 4.80	272.0 10.71	8 8	178	5



BE-8710





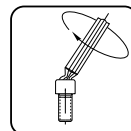
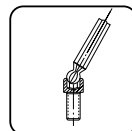
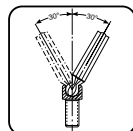

Product code	EAN code 731415+	 mm inch	 mm inch	 mm inch		 g	
BE-8710	0027705	150.0 5.90	36.0 x 161.0 1.42 x 6.34	311.0 12.24	10 10	250	5





Screwdrivers

MULTI-TIP SCREWDRIVER 1/4"

Product code	EAN code 731415+	 mm inch	 mm inch			
8576A	0028054	118.0 4.65	246.0 9.68	0.8 x 5.5 0.03 x 0.22 PH1, PH2 PZ1, PZ2	1/4"	160 5

*With strong magnet to hold bits and screws.
With holder in handle for up to 5 bits. Supplied with 5 bits.*



8576A



Screwdrivers

SETS



NEW

BE-9881

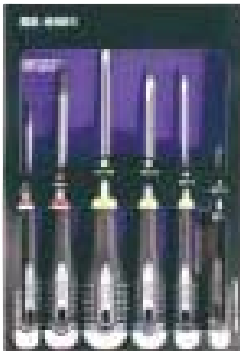

Product code

EAN code
731415+



BE-9881
6 pieces.

0043279

BE-8020
0.5x3x50
BE-8040
0.8x4x100
BE-8150
1x5.5x100
BE-8155
1.2x6.5x125

BE-8610
PH 1x75
BE-8620
PH 2x100

450

1



NEW

BE-9882



Product code

EAN code
731415+



BE-9882
6 pieces.

1839284

BE-8020
0.5x3x50
BE-8040
0.8x4x100
BE-8150
1x5.5x100
BE-8155
1.2x6.5x125

BE-8810
PZ 1x75
BE-8820
PZ 2x100

450

1



NEW

BE-9883



Product code

EAN code
731415+



BE-9883
6 pieces.

1839291

BE-8810
PZ 1x75
BE-8820
PZ 2x100
BE-8830
PZ 3x150

BE-8910
T10
BE-8915
T15
BE-8925
T25

450

1





Screwdrivers

S E T S



NEW





BE-9885

Product code	EAN code 731415+			
BE-9885 <i>5 pieces.</i>	0048465	BE-8910 T10 BE-8915 T15 BE-8920 T20 BE-8925 T25 BE-8930 T30	355	1



NEW

BE-9886

Product code	EAN code 731415+					
BE-9886 <i>6 pieces.</i>	0048472	BE-8030 0.6x3.5x75 8150 1x5.5x100	BE-8610 PH 1x75 BE-8620 PH 2x100	BE-8810 PZ 1x75 BE-8820 PZ 2x100	430	1





Tool Kits

K I T S

NEW

9841



Product code EAN code Dimensions
731415+ mm/inch



9841 0107445 40x240x155/1.6x9.6x6.2

220 1

Contents

7190	Side cutter 109 mm/4.4	BE-8610	Phillips® screwdriver PH 1
7890	Snipe nose pliers 132 mm/5.3	8070	Adjustable wrench 155 mm/6.0
TL AA-SA	Tweezer, strong fine tips 130 mm/5.2		
BE-8020	Slotted screwdriver 0.5x3.0 mm/0.02x0.11		
BE-8040	Slotted screwdriver 0.8x4.0 mm/0.03x0.15		

NEW

9845



Product code EAN code Dimensions
731415+ mm/inch



9845 0107476 40x310x220/1.6x12.4x8.8

1295 1

Contents

2430G-160	Snipe nose pliers 160 mm/6.4	BE-8020	Slotted screwdriver 0.5x3.0 mm/0.02x0.11
2101G-160	Side cutter 160 mm/6.4	BE-8040	Slotted screwdriver 0.8x4.0 mm/0.03x0.15
2628G-160	Combination pliers 160 mm/6.4	BE-8150	Slotted screwdriver 1.0x5.5 mm/0.04x0.21
9070P	Comb adjustable wrench 155 mm/6.0	BE-8610	Phillips® screwdriver PH 1
		BE-8620	Phillips® screwdriver PH 2

NEW

9848



Product code EAN code Dimensions
731415+ mm/inch



9848 0111015 40x240x150/1.6x9.6x6

380 1



Contents

8160	Side cutter 125 mm/5.0	BE-8020	Slotted screwdriver 0.5x3.0 mm/0.02x0.11
7890	Snipe nose pliers 132 mm/5.3	BE-8040	Slotted screwdriver 0.8x4.0 mm/0.03x0.15
TL AA-SA	Tweezer, strong fine tips 130 mm/5.2	BE-8610	Phillips® screwdriver PH 1
		8070	Adjustable wrench 155 mm/6.0



Tool Kits

K I T S

Product code	EAN code	Dimensions mm/inch	Description		
9850	0111343	490x390x120/19.6x15.6x4.8	L indstrom Tool Kit*	13500	1
9851	0111411	490x390x120/19.6x15.6x4.8	L indstrom Tool Kit* **	13500	1

NEW

**9850
9851**

Contents

8070	Adjustable/6.0	2047PR-1-2	Double offset PH 1 and 2
9072P	Reversible/10.0	2744	Multi Purpose Shear
2628-180	Combination pliers/7.2	479-08	Claw hammer
2430G-160	Snipe nose pliers/6.4	TL 7314 SA	Tweezers, general purpose (serrated)
2128G-160	Side cutters/6.4	TL 475 SA	Tweezers, fine pointed
2223D-150	Wire strippers/6.0	BE-9770	Hexagon socket set
8140	Electronic side cutters small	5515L	Small mirror
8160	Electronic side cutters medium	2509	Flexible pick-up tool
7890	Electronic side cutters short	8045LVDE	Voltage tester
7291	Electronic end cutter	5552	Trimming knife
208	Mini hacksaw	1-473-08-2-2	File set
268	Junior hacksaw	2-470-14-2-0	Needle file set
BE-8220	Screwdrivers 3.0 mm/0.11 (long blade)	1933M/6T	Small double open-end spanner set
BE-8040	Screwdrivers 4.0 mm/0.15	2800N	Small cable cutters
BE-8150	Screwdrivers 5.5 mm/0.21		Tap measure 3 m
BE-8155	Screwdrivers 6.5 mm/0.26		Cutting knife
BE-8800	PZ 0		Soldering iron
BE-8810	PZ 1		De-soldering disp.
BE-8820	PZ 2		Tool box
7200/S7	Precision screwdriver set		

* Euro plug
** U.K. plug



Product code	EAN code	Dimensions mm/inch	Description		
9852	0114092	40x310x220/1.6x12.4x8.8		1985	1

NEW

9852

Contents

8070	Adjustable wrench 155 mm/6.0	8045 LVDE	Voltage tester 150-250 V
2421G-160	Flat nose pliers 160 mm/6.4	8160	Side cutter 125 mm/5.0
2101G-160	Side cutter 160 mm/6.4	7890	Snipe nose plier 132 mm/5.3
2628G-180	Combination pliers 180 mm/7.2	TL AA-SA	Tweezer, strong fine tips 130 mm/5.2
BE-8210	Slotted screwdriver 0.4x2.5 mm/0.01x0.09	TL K-AP	Knife
BE-8040	Slotted screwdriver 0.8x4.0 mm/0.03x0.15	TM3M	Tape measure
BE-8150	Slotted screwdriver 1.0x5.5 mm/0.04x0.21		
BE-8155	Slotted screwdriver 1.2x6.5 mm/0.05x0.26		
BE-8600	Phillips® screwdriver PH 0		
BE-8610	Phillips® screwdriver PH 1		
BE-8620	Phillips® screwdriver PH 2		





Spare Parts

RETURN BIOSPRING FOR RX-SERIES

RX 01



Product code EAN code
731415+



RX 01 0103263

5

1

5 springs for Rx-Series packed in a plastic bag.

RETURN SPRING FOR 80-SERIES

8130-50
8160



Product code EAN code
731415+



8130-50 / supr. spring 0111572
8160 / spring 0111589

2

1

Return springs for 80-Series packed in a plastic bag.

LEAD CATCHERS

813/814



Product code EAN code
731415+



813 0055852 For cutters 8130-8132, RX 8130-8132
814 0055845 For cutters 8140-8148, RX 8140-8148

4

5

4

5



Warranty

Lindstrom brand tools carry a full guarantee covering defects in materials and workmanship. Tools subjected to abnormal use, abuse, alteration or used after the tool is significantly worn are not covered by this warranty. For tool evaluation and warranty coverage, please contact your Lindstrom Distributor.





Index by Type

<u>CUTTERS</u>	<u>PAGE</u>	<u>CUTTERS</u>	<u>PAGE</u>	<u>PLIERS</u>	<u>PAGE</u>
OVAL		TAPERED AND RELIEVED		Rx7490	47
Rx8130	9, 12, 25, 27, 42	Rx8146	13, 16, 26, 43	Rx7590	48
Rx8131	42	Rx8147	43	Rx7890	18, 20, 24, 26, 48
Rx8132	42	Rx8148	43	Rx7891	20, 48
Rx8140	8, 14, 16, 17, 28, 39, 42	7191	54	Rx7892	19, 49
Rx8141	23, 42	8146	51	Rx7893	49
Rx8142	42	8147	51	7490	57
Rx8150	42	8148	51	7590	58
Rx8151	42	8156	51	7890	18, 28, 30, 58
Rx8152	42	8157	51	7891	18, 58
Rx8160	42	8158	51	7892	20, 59
Rx8161	42			7893	59
Rx8162	42				
8130	50	TIP		MULTI-PURPOSE SHEAR	PAGE
8131	50	Rx8149	13, 44	HS6000	2, 31, 60
8132	50	8149	52		
8140	9, 18, 29, 50				
8141	50	MICRO TIP			
8142	50	Rx8233	2, 44		
8150	50	Rx8234	2, 45		
8150J	50				
8151	50	MICRO TIP ANGLE			
8152	50	Rx8237	2, 46		
8160	50				
8160J	50	ANGLE			
8161	50	Rx8211	7, 14, 45		
8162	50	Rx8247	4, 10, 14, 37, 46		
		Rx8248	10, 47		
		7280	55		
TAPERED		7285	55		
Rx8143	12, 43	7290	56		
Rx8144	43	7291	56		
Rx8145	43	7293	56		
7190	54	8211	52		
8143	51	8247	53		
8144	51	8248	53		
8145	51				
8153	51	MINIATURE END			
8154	51	7292	57		
8155	51				
8163	51				
8164	51				
8165	51				



Index by Type

<u>TWEEZERS</u>	<u>PAGE</u>	<u>TWEEZERS</u>	<u>PAGE</u>	<u>TWEEZERS</u>	<u>PAGE</u>		
HIGH PRECISION							
TL 00B-SA _____	61	GENERAL PURPOSE					
TL 00D-SA _____	61	TL 119A-SA _____	69	TL 574-SAC _____	76		
TL 00-SA _____	61	TL 119-SA _____	69	TL 574-SA Cu _____	76		
TL 0C9-SA _____	61	TL 120A-SA _____	69	BOLEY STYLE			
TL 0-SA _____	61	TL 120-SA _____	69	TL AA-S _____	77		
TL 10G-SA _____	62	TL 121-SA _____	69	TL AA-SA _____	77		
TL 15A _____	62	TL 122-SA _____	70	TL AA-SAC _____	77		
TL 15 AGW _____	62	TL 123-SA _____	70	TL AA-TA _____	77		
TL 15AP _____	62	TL 124-SA _____	70	TL GG-SA _____	77		
TL 1-SA _____	62	TL 2AX-SA _____	70	TL MM-SA _____	78		
TL 27-SA _____	63	EXTRA STRENGTH					
TL 2AB-SA _____	63	GENERAL PURPOSE					
TL 2A-SA _____	63	TL 475-SA _____	71	TL 248CF-SA _____	78		
TL 2-SA _____	63	TL 648-SA _____	71	TL 249CF-SA _____	32, 61, 78		
TL 34A-SA _____	63	TL 648-NC _____	71	TL 250CF-SA _____	79		
TL 35A-SA _____	64	TL 649-SA _____	71	TL 251-SA _____	79		
TL 3C-SA _____	64	TL 649-NC _____	71	TL 252-SA _____	79		
TL 3C-TA _____	64	TL 231-SA _____	72	TL 253-SA _____	79		
TL 3-SA _____	64	BLUNT TIP					
TL 3-TA _____	64	TL 7312-SA _____	72	TL 254-SA _____	79		
TL 4-SA _____	65	TL 7312-NC _____	72	TL 255-SA _____	80		
TL 4A-SA _____	65	TL 7314-SA _____	72	TL 256-SA _____	80		
TL 51S-SA _____	65	TL 7314-NC _____	73	TL 257-SA _____	80		
TL 5A-SA _____	65	TL 7316-SA _____	73	TL 259CF-SA _____	80		
TL 5B-SA _____	65	TL 7316-NC _____	73	TL 269CF-SA _____	80		
TL 5C-SA _____	66	TL 7320-SA _____	73	SMD			
TL 5-SA _____	66	TL 7320-NC _____	73	TL SM 100-SA _____	81		
TL 5-TA _____	66	COMPONENT HANDLING					
TL 6-SA _____	66	TL 571-SA _____	74	TL SM 101-SA _____	81		
TL 65A-SA _____	66	TL 572-SA _____	74	TL SM 102-SA _____	81		
TL 7A-SA _____	67	TL 573-SA _____	74	TL SM 103-SA _____	81		
TL 7-SA _____	67	TL 577-SA _____	74	TL SM 104-SA _____	81		
TL AC-SA _____	67	TL 578-SA _____	74	TL SM 105-SA _____	82		
TL F-SA _____	67	TL 579-SA _____	75	TL SM 106-SA _____	82		
TL H-SA _____	67	TL 582-SA _____	75	TL SM 107-SA _____	82		
TL S-SA _____	68	TL 58A-SA _____	32, 75	TL SM 108-SA _____	82		
TL SS-EP _____	68	TL 29D-SA _____	21, 32, 75	TL SM 109-SA _____	82		
TL SSG-SA _____	68	TL 30-SA _____	75	TL SM 110-SA _____	83		
TL SS-SA _____	68	TL 31-SA _____	76	TL SM 111-SA _____	83		
		TL 574B-SA _____	76	TL SM 112-SA _____	83		
		TL 574-SA _____	76	TL SM 113-SA _____	83		
				TL SM 114-SA _____	21, 83		
				TL SM 115-SA _____	84		
				TL SM 116-SA _____	84		
				TL SM 117-SA _____	84		



Index by Type

TWEEZERS SETS **PAGE**

FINE TIP
 9858 _____ 85

STRONG TIP
 9859 _____ 85

TITANIUM
 9856 _____ 86

HIGH PRECISION
 9855 _____ 87
 9857 _____ 86

SMD
 9854 _____ 3, 87

TORQUE SCREWDRIVERS **PAGE**

MA500-1 _____ 3, 33, 88
 MA500-2 _____ 33, 88
 MA500-3 _____ 33, 88
 MAL500-1 _____ 88
 MAL500-2 _____ 88
 MAL500-3 _____ 88
 PS501-1 _____ 33, 88
 PS501-2 _____ 33, 88
 PS501-3 _____ 33, 88
 PS501-4 _____ 33, 88

TORQUE SCREWDR. SETS **PAGE**

TSK505 _____ 3, 89

SCREWDRIVERS **PAGE**

SLOTTED
 BE-8010 _____ 34, 90
 BE-8020 _____ 35, 90
 BE-8020L _____ 90
 BE-8030 _____ 90
 BE-8040 _____ 90
 BE-8150 _____ 90
 BE-8155 _____ 90
 BE-8210 _____ 90
 BE-8220 _____ 90
 BE-8230 _____ 90
 BE-8240 _____ 90
 BE-8250 _____ 90
 BE-8250L _____ 90

SCREWDRIVERS **PAGE**

BE-8255 _____ 90
 BE-8160 _____ 91
 BE-8260 _____ 91
 BE-8865 _____ 91
 BE-8870 _____ 91
 BE-8880 _____ 91
 BE-8890 _____ 91

SLOTTED STUBBY TYPE

BE-8330 _____ 91
 BE-8340 _____ 91
 BE-8350 _____ 91
 BE-8355 _____ 91
 BE-8360 _____ 91
 BE-8450 _____ 2, 91
 BE-8455 _____ 91

PHILLIPS® PH

BE-8600 _____ 25, 34, 92
 BE-8610 _____ 92
 BE-8610L _____ 92
 BE-8620 _____ 92
 BE-8620L _____ 92
 BE-8630 _____ 92
 BE-8640 _____ 92

PHILLIPS® PH STUBBY TYPE

BE-8601 _____ 93
 BE-8602 _____ 2, 93

POZIDRIV® PZ

BE-8800 _____ 34, 93
 BE-8810 _____ 93
 BE-8810L _____ 93
 BE-8820 _____ 93
 BE-8820L _____ 93
 BE-8830 _____ 94
 BE-8840 _____ 94

POZIDRIV® PZ STUBBY TYPE

BE-8801 _____ 94
 BE-8802 _____ 2, 94

TORX®

BE-8906 _____ 95
 BE-8907 _____ 95
 BE-8908 _____ 95
 BE-8909 _____ 95
 BE-8910 _____ 95
 BE-8915 _____ 95

SCREWDRIVERS **PAGE**

BE-8920 _____ 95
 BE-8925 _____ 95
 BE-8927 _____ 95
 BE-8930 _____ 95
 BE-8940 _____ 95
 BE-8945 _____ 95

HEXAGON SOCKET

BE-8702 _____ 96
 BE-8703 _____ 96
 BE-8704 _____ 96
 BE-8705 _____ 96
 BE-8706 _____ 96
 BE-8708 _____ 96
 BE-8725 _____ 96
 BE-8710 _____ 96

MULTI TIP SCREWDRIVER 1/4"

8576A _____ 97

SCREWDRIVERS SETS **PAGE**

BE-9881 _____ 2, 98
 BE-9882 _____ 2, 98
 BE-9883 _____ 98
 BE-9885 _____ 99
 BE-9886 _____ 2, 99

TOOL KITS **PAGE**

9841 _____ 100
 9845 _____ 3, 100
 9848 _____ 3, 100
 9850 _____ 3, 101
 9851 _____ 3, 101
 9852 _____ 3, 101

SPARE PARTS **PAGE**

RETURN SPRING FOR RX-SERIES
 Rx01 _____ 27, 102

RETURN SPRING FOR 80-SERIES
 8130-50/Supr. spring _____ 102
 8160/Spring _____ 102

LEAD CATCHERS
 813 _____ 17, 28, 29, 39, 102
 814 _____ 17, 28, 29, 39, 102



Index by Alphanumeric Sequence

<u>PAGE</u>	<u>PAGE</u>	<u>PAGE</u>			
7190 _____	54	8247 _____	53	BE-8703 _____	96
7191 _____	54	8248 _____	53	BE-8704 _____	96
7280 _____	55	8576A _____	97	BE-8705 _____	96
7285 _____	55	9841 _____	100	BE-8706 _____	96
7290 _____	56	9845 _____	3, 100	BE-8708 _____	96
7291 _____	56	9848 _____	3, 100	BE-8710 _____	96
7292 _____	57	9850 _____	3, 101	BE-8725 _____	96
7293 _____	56	9851 _____	3, 101	BE-8800 _____	34, 93
7490 _____	57	9852 _____	3, 101	BE-8801 _____	94
7590 _____	58	9854 _____	3, 87	BE-8802 _____	2, 94
7890 _____	18, 28, 30, 58	9855 _____	87	BE-8810 _____	93
7891 _____	18, 58	9856 _____	86	BE-8810L _____	93
7892 _____	20, 59	9857 _____	86	BE-8820 _____	93
7893 _____	59	9858 _____	85	BE-8820L _____	93
813 _____	17, 28, 29, 39, 102	9859 _____	85	BE-8830 _____	94
8130 _____	50	BE-8010 _____	34, 90	BE-8840 _____	94
8130-50/Supr. spring _____	102	BE-8020 _____	35, 90	BE-8865 _____	91
8131 _____	50	BE-8020L _____	90	BE-8870 _____	91
8132 _____	50	BE-8030 _____	90	BE-8880 _____	91
814 _____	17, 28, 29, 39, 102	BE-8040 _____	90	BE-8890 _____	91
8140 _____	9, 18, 29, 50	BE-8150 _____	90	BE-8906 _____	95
8141 _____	50	BE-8155 _____	90	BE-8907 _____	95
8142 _____	50	BE-8160 _____	91	BE-8908 _____	95
8143 _____	51	BE-8210 _____	90	BE-8909 _____	95
8144 _____	51	BE-8220 _____	90	BE-8910 _____	95
8145 _____	51	BE-8230 _____	90	BE-8915 _____	95
8146 _____	51	BE-8240 _____	90	BE-8920 _____	95
8147 _____	51	BE-8250 _____	90	BE-8925 _____	95
8148 _____	51	BE-8250L _____	90	BE-8927 _____	95
8149 _____	52	BE-8255 _____	90	BE-8930 _____	95
8150 _____	50	BE-8260 _____	91	BE-8940 _____	95
8150J _____	50	BE-8330 _____	91	BE-8945 _____	95
8151 _____	50	BE-8340 _____	91	BE-9881 _____	2, 98
8152 _____	50	BE-8350 _____	91	BE-9882 _____	2, 98
8153 _____	51	BE-8355 _____	91	BE-9883 _____	98
8154 _____	51	BE-8360 _____	91	BE-9885 _____	99
8155 _____	51	BE-8450 _____	91	BE-9886 _____	2, 99
8156 _____	51	BE-8455 _____	2, 91	HS6000 _____	2, 31, 60
8157 _____	51	BE-8600 _____	25, 34, 92	MA500-1 _____	3, 33, 88
8158 _____	51	BE-8601 _____	93	MA500-2 _____	33, 88
8160 _____	50	BE-8602 _____	2, 93	MA500-3 _____	33, 88
8160/Spring _____	102	BE-8610 _____	92	MAL500-1 _____	88
8160J _____	50	BE-8610L _____	92	MAL500-2 _____	88
8161 _____	50	BE-8620 _____	92	MAL500-3 _____	88
8162 _____	50	BE-8620L _____	92	PS501-1 _____	33, 88
8163 _____	51	BE-8630 _____	92	PS501-2 _____	33, 88
8164 _____	51	BE-8640 _____	92	PS501-3 _____	33, 88
8165 _____	51	BE-8702 _____	96	PS501-4 _____	33, 88
8211 _____	52	BE-8703 _____	96		



Index by Alphanumeric Sequence

	PAGE		PAGE		PAGE
Rx01	27, 102	TL 1-SA	62	TL 648-NC	71
Rx7490	47	TL 231-SA	72	TL 648-SA	71
Rx7590	48	TL 248CF-SA	78	TL 649-NC	71
Rx7890	18, 20, 24, 26, 48	TL 249CF-SA	32, 61, 78	TL 649-SA	71
Rx7891	20, 48	TL 250CF-SA	79	TL 65A-SA	66
Rx7892	19, 49	TL 251-SA	79	TL 6-SA	66
Rx7893	49	TL 252-SA	79	TL 7312-NC	72
Rx8130	9, 12, 25, 27, 42	TL 253-SA	79	TL 7312-SA	72
Rx8131	42	TL 254-SA	79	TL 7314-NC	73
Rx8132	42	TL 255-SA	80	TL 7314-SA	72
Rx8140	8, 14, 16, 17, 28, 39, 42	TL 256-SA	80	TL 7316-NC	73
Rx8141	23, 42	TL 257-SA	80	TL 7316-SA	73
Rx8142	42	TL 259CF-SA	80	TL 7320-NC	73
Rx8143	12, 43	TL 269CF-SA	80	TL 7320-SA	73
Rx8144	43	TL 27-SA	63	TL 7A-SA	67
Rx8145	43	TL 29D-SA	21, 32, 75	TL 7-SA	67
Rx8146	13, 16, 26, 43	TL 2AB-SA	63	TL AA-S	77
Rx8147	43	TL 2A-SA	63	TL AA-SA	77
Rx8148	43	TL 2AX-SA	70	TL AA-SAC	77
Rx8149	13, 44	TL 2-SA	63	TL AA-TA	77
Rx8150	42	TL 30-SA	75	TL AC-SA	67
Rx8151	42	TL 31-SA	76	TL F-SA	67
Rx8152	42	TL 34A-SA	63	TL GG-SA	77
Rx8160	42	TL 35A-SA	64	TL H-SA	67
Rx8161	42	TL 3C-SA	64	TL MM-SA	78
Rx8162	42	TL 3C-TA	64	TL RR-SA	78
Rx8211	7, 14, 45	TL 3-SA	64	TL SM 100-SA	81
Rx8233	2, 44	TL 3-TA	64	TL SM 101-SA	81
Rx8234	2, 45	TL 475-SA	71	TL SM 102-SA	81
Rx8237	2, 46	TL 4A-SA	65	TL SM 103-SA	81
Rx8247	4, 10, 14, 37, 46	TL 4-SA	65	TL SM 104-SA	81
Rx8248	10, 47	TL 51S-SA	65	TL SM 105-SA	82
TL 00B-SA	61	TL 571-SA	74	TL SM 106-SA	82
TL 00D-SA	61	TL 572-SA	74	TL SM 107-SA	82
TL 00-SA	61	TL 573-SA	74	TL SM 108-SA	82
TL 0C9-SA	61	TL 574B-SA	76	TL SM 109-SA	82
TL 0-SA	61	TL 574-SA Cu	76	TL SM 110-SA	83
TL 10G-SA	62	TL 574-SA	76	TL SM 111-SA	83
TL 119A-SA	69	TL 574-SAC	76	TL SM 112-SA	83
TL 119-SA	69	TL 577-SA	74	TL SM 113-SA	83
TL 120A-SA	69	TL 578-SA	74	TL SM 114-SA	21, 83
TL 120-SA	69	TL 579-SA	75	TL SM 115-SA	84
TL 121-SA	69	TL 582-SA	75	TL SM 116-SA	84
TL 122-SA	70	TL 58A-SA	32, 75	TL SM 117-SA	84
TL 123-SA	70	TL 5A-SA	65	TL S-SA	68
TL 124-SA	70	TL 5B-SA	65	TL SS-EP	68
TL 15 AGW	62	TL 5C-SA	66	TL SSG-SA	68
TL 15A	62	TL 5-SA	66	TL SS-SA	68
TL 15AP	62	TL 5-TA	66	TSK505	3, 89



Conversion Tables

DECIMALS TO MILLIMETERS

inches	decimals	mm
1/64	0.015625	0.397
3/64	0.046875	1.191
5/64	0.078125	1.984
7/64	0.109375	2.778
9/64	0.140625	3.572
11/64	0.171875	4.366
13/64	0.203125	5.159
15/64	0.234375	5.953
17/64	0.265625	6.747
19/64	0.296875	7.541
21/64	0.328125	8.334
23/64	0.359375	9.128
25/64	0.390625	9.922
27/64	0.421875	10.716
29/64	0.453125	11.509
31/64	0.484375	12.303
33/64	0.515625	13.097
35/64	0.546875	13.891
37/64	0.578125	14.684
39/64	0.609375	15.478
41/64	0.640625	16.272
43/64	0.671875	17.066
45/64	0.703125	17.859
47/64	0.734375	18.653
49/64	0.765625	19.447
51/64	0.796875	20.241
53/64	0.828125	21.034
55/64	0.859375	21.828
57/64	0.890625	22.622
59/64	0.921875	23.416
61/64	0.953125	24.209
63/64	0.984375	25.003

1 mm = .03937 inch.
.001 inch = .0254 mm.

MILLIMETERS TO DECIMALS

mm	inches	mm	inches	mm	inches
0.1	0.0039	29	1.1417	66	2.5984
0.2	0.0079	30	1.1811	67	2.6378
0.3	0.0118	31	1.2205	68	2.6772
0.4	0.0157	32	1.2598	69	2.7165
0.5	0.0197	33	1.2992	70	2.7559
0.6	0.0236	34	1.3386	71	2.7953
0.7	0.0276	35	1.3780	72	2.8346
0.8	0.0315	36	1.4173	73	2.8740
0.9	0.0354	37	1.4567	74	2.9134
1	0.0394	38	1.4961	75	2.9528
2	0.0787	39	1.5354	76	2.9921
3	0.1181	40	1.5748	77	3.0315
4	0.1575	41	1.6142	78	3.0709
5	0.1969	42	1.6535	79	3.1102
6	0.2362	43	1.6929	80	3.1496
7	0.2756	44	1.7323	81	3.1890
8	0.3150	45	1.7717	82	3.2283
9	0.3543	46	1.8110	83	3.2677
10	0.3937	47	1.8504	84	3.3071
11	0.4331	48	1.8898	85	3.3465
12	0.4724	49	1.9291	86	3.3858
13	0.5118	50	1.9685	87	3.4252
14	0.5512	51	2.0079	88	3.4646
15	0.5906	52	2.0472	89	3.5039
16	0.6299	53	2.0866	90	3.5433
17	0.6693	54	2.1260	91	3.5827
18	0.7087	55	2.1654	92	3.6220
19	0.7480	56	2.2047	93	3.6614
20	0.7874	57	2.2441	94	3.1008
21	0.8268	58	2.2835	95	3.7402
22	0.8661	59	2.3228	96	3.7795
23	0.9055	60	2.3622	97	3.8189
24	0.9449	61	2.4016	98	3.8583
25	0.9843	62	2.4409	99	3.8976
26	1.0236	63	2.4803	100	3.9370
27	1.0630	64	2.5197		
28	1.1024	65	2.5591		



Conversion Tables

COMPARISON OF WIRE GAUGES DIAMETER OF WIRE IN INCHES

Gauge No.	Brown & Sharpe	Stub's or Birmingham	Imperial or Brit. Std.
0000	0.4600	0.454	0.400
000	0.4096	0.425	0.372
00	0.3648	0.380	0.348
0	0.3249	0.340	0.324
1	0.2893	0.300	0.300
2	0.2576	0.284	0.276
3	0.2294	0.259	0.252
4	0.2043	0.238	0.232
5	0.1819	0.220	0.212
6	0.1620	0.203	0.192
7	0.1443	0.180	0.176
8	0.1285	0.165	0.160
9	0.1144	0.148	0.144
10	0.1019	0.134	0.128
11	0.0907	0.120	0.116
12	0.0808	0.109	0.104
13	0.0720	0.095	0.092
14	0.0941	0.083	0.080
15	0.0571	0.072	0.072
16	0.0508	0.065	0.064
17	0.0453	0.058	0.056
18	0.0403	0.049	0.048
19	0.0359	0.042	0.040
20	0.0320	0.035	0.036
21	0.0285	0.032	0.032
22	0.0254	0.028	0.028
23	0.0226	0.025	0.024
24	0.0201	0.022	0.022
25	0.0179	0.020	0.020
26	0.0159	0.018	0.018
27	0.0142	0.016	0.0164
28	0.0126	0.014	0.0149
29	0.0113	0.013	0.0136
30	0.0100	0.012	0.0124
31	0.0089	0.010	0.0116
32	0.0080	0.009	0.0100
33	0.0071	0.008	0.0100
34	0.0063	0.007	0.0092
35	0.0056	0.005	0.0084
36	0.0050	0.004	0.0076
37	0.0045	-	0.0068
38	0.0040	-	0.0060
39	0.0035	-	0.0052
40	0.0031	-	0.0048

WIRE DIAMETERS

Awg	dia. of solid wire (inches)	dia. of stranded wire (inches)	dia. of solid wire (mm)	dia. of stranded wire (mm)
3	0.128	0.145 - 0.149	3.251	3.68 - 3.78
10	0.102	0.116 - 0.119	2.590	2.45 - 3.02
12	0.81	0.091 - 0.093	2.057	2.31 - 2.36
14	0.64	0.072 - 0.074	1.625	1.82 - 1.88
16	0.051	0.058 - 0.060	1.295	1.47 - 1.52
18	0.040	0.047 - 0.049	1.016	1.19 - 1.24
20	0.032	0.038 - 0.040	0.813	0.965 - 1.02
22	0.025	0.029 - 0.030	0.635	0.736 - 0.762
24	0.020	0.024 - 0.025	0.508	0.609 - 0.635
26	0.016	0.019 - 0.020	0.406	0.482 - 0.508
28	0.013	0.016 - 0.017	0.330	0.406 - 0.432
30	0.010	0.012 - 0.013	0.254	0.305 - 0.330

Capacity and Options















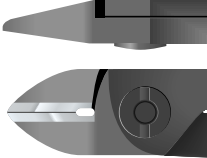

											CUTTING CAPACITY				
											COPPER WIRE				
PART NO. ¹	SIZE	SHAPE	CUT OR SURFACE	HANDLE OPTIONS				L / C	PAGE	GAUGE	38	24	18	15	12
				Rx	CO	DS	HS			INCH	.004	.02	.039	.059	.079
									MM	0.1	0.5	1.0	1.5	2.0	
CUTTERS	8130	XS	O	MB	■	■	■	■	✓	42, 50					
	8131	XS	O	F	■	■	■	■	✓	42, 50					
	8132	XS	O	UF	■	■	■	■	✓	42, 50					
	8140	S	O	MB	■	■	■	■	✓	42, 50					
	8141	S	O	F	■	■	■	■	✓	42, 50					
	8142	S	O	UF	■	■	■	■	✓	42, 50					
	8143	S	T	MB	■	■	■	■	✓	43, 51					
	8144	S	T	F	■	■	■	■	✓	43, 51					
	8145	S	T	UF	■	■	■	■	✓	43, 51					
	8146	S	T&R	MB	■	■	■	■	✓	43, 51					
	8147	S	T&R	F	■	■	■	■	✓	43, 51					
	8148	S	T&R	UF	■	■	■	■	✓	43, 51					
	8149	S	TP	F	■	■	■	■	✓	44, 52					
	8150	M	O	MB	■	■	■	■	✓	42, 50	3				
	8150 J ²	M	O	MB	■	■	■	■	✓	50	3				
	8151	M	O	F	■	■	■	■	✓	42, 50					
	8152	M	O	UF	■	■	■	■	✓	42, 50					
	8153	M	T	MB	■	■	■	■	✓	43, 51					
	8154	M	T	F	■	■	■	■	✓	43, 51					
	8155	M	T	UF	■	■	■	■	✓	43, 51					
	8156	M	T&R	MB	■	■	■	■	✓	51					
	8157	M	T&R	F	■	■	■	■	✓	51					
	8158	M	T&R	UF	■	■	■	■	✓	51					
	8160	L	O	MB	■	■	■	■	✓	42, 50					
	8160 J ²	L	O	MB	■	■	■	■	✓	50					
	8161	L	O	F	■	■	■	■	✓	42, 50					
	8162	L	O	UF	■	■	■	■	✓	42, 50					
	8163	L	T	MB	■	■	■	■	✓	51					
	8164	L	T	F	■	■	■	■	✓	51					
	8165	L	T	UF	■	■	■	■	✓	51					
8211	S	A 20°	F	■	■	■	■	✓	45						
8233	XS	T 10°	UF	■	■	■	■	✓	44						
8234	XS	T 10°	UF	■	■	■	■	✓	45						
8237	XS	A 50°	UF	■	■	■	■	✓	46						
8247	S	A 45°	F	■	■	■	■	✓	46						
8248	S	A 45°	F	■	■	■	■	✓	47, 53						
7190	S	T	MB	■	■	■	■	✓	54						
7191	S	T	F	■	■	■	■	✓	54						
7280	S	A	F	■	■	■	■	✓	55						
7285	S	A	F	■	■	■	■	✓	55						
7290	S	A	MB	■	■	■	■	✓	56						
7291	S	A	F	■	■	■	■	✓	56						
7292	S	ED	F	■	■	■	■	✓	57						
7293	S	A	F	■	■	■	■	✓	56						
PLIERS	7490	S	SM	■	■	■	■	✓	47, 57						
	7590	S	SM	■	■	■	■	✓	48, 58						
	7890	M	SM	■	■	■	■	✓	48, 58						
	7891	M	SE	■	■	■	■	✓	48, 58						
	7892	M	SM	■	■	■	■	✓	49, 59						
7893	S	SM	■	■	■	■	✓	49, 59							

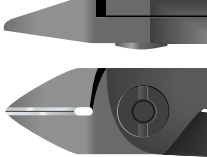
1 All part numbers as listed come standard with molded plastic handles and springs.

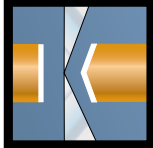
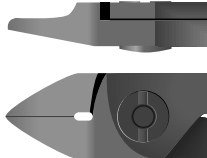
2 Type "J" edges for stripping and cutting insulated copper wire.

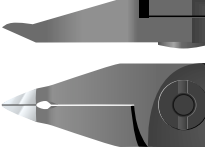
3 Max .16"/.4 mm springwire.

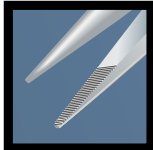
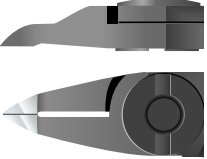
Capacity and Options

SIZE				ACTUAL SIZE	
XS	Extra Small				
S	Small				
M	Medium				
L	Large				
SHAPE					
O	Oval				
T	Tapered				
T&R	Tapered & Relieved				
A	Angle				
TP	Tip				
ED	End				
CUT OR SURFACE					
MB	Micro-Bevel				
F	Flush				
UF	Ultra-Flush				
SM	Smooth				
SE	Serrated				
HANDLE OPTIONS					
 RX	The ultimate in ergonomic and ESD safe handles.				
 CO	Standard handle shape in conductive material.				
 DS	Slip-on handle in dissipative material. (E.U. only)				
 HS	Traditional ergonomic handle shape in dissipative material. (U.S. only)				
To order handle options, add two letter prefix to part no. = Rx8130.					
LEAD CATCHER					
 L/C	Lead-Catcher available, add "S" suffix to part no. = 8130-S.				
					8130 XS / Extra Small
					8140 S / Small
					8150 M / Medium
					8160 L / Large
					7893 S / Small
					7890 M / Medium

Capacity and Options















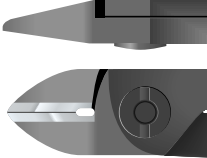

											CUTTING CAPACITY				
											COPPER WIRE				
PART NO. ¹	SIZE	SHAPE	CUT OR SURFACE	HANDLE OPTIONS				L / C	PAGE	GAUGE	38	24	18	15	12
				Rx	CO	DS	HS			INCH	.004	.02	.039	.059	.079
									MM	0.1	0.5	1.0	1.5	2.0	
CUTTERS	8130	XS	O	MB	■	■	■	■	✓	42, 50					
	8131	XS	O	F	■	■	■	■	✓	42, 50					
	8132	XS	O	UF	■	■	■	■	✓	42, 50					
	8140	S	O	MB	■	■	■	■	✓	42, 50					
	8141	S	O	F	■	■	■	■	✓	42, 50					
	8142	S	O	UF	■	■	■	■	✓	42, 50					
	8143	S	T	MB	■	■	■	■	✓	43, 51					
	8144	S	T	F	■	■	■	■	✓	43, 51					
	8145	S	T	UF	■	■	■	■	✓	43, 51					
	8146	S	T&R	MB	■	■	■	■	✓	43, 51					
	8147	S	T&R	F	■	■	■	■	✓	43, 51					
	8148	S	T&R	UF	■	■	■	■	✓	43, 51					
	8149	S	TP	F	■	■	■	■	✓	44, 52					
	8150	M	O	MB	■	■	■	■	✓	42, 50	3				
	8150 J ²	M	O	MB	■	■	■	■	✓	50	3				
	8151	M	O	F	■	■	■	■	✓	42, 50					
	8152	M	O	UF	■	■	■	■	✓	42, 50					
	8153	M	T	MB	■	■	■	■	✓	43, 51					
	8154	M	T	F	■	■	■	■	✓	43, 51					
	8155	M	T	UF	■	■	■	■	✓	43, 51					
	8156	M	T&R	MB	■	■	■	■	✓	51					
	8157	M	T&R	F	■	■	■	■	✓	51					
	8158	M	T&R	UF	■	■	■	■	✓	51					
	8160	L	O	MB	■	■	■	■	✓	42, 50					
	8160 J ²	L	O	MB	■	■	■	■	✓	50					
	8161	L	O	F	■	■	■	■	✓	42, 50					
	8162	L	O	UF	■	■	■	■	✓	42, 50					
	8163	L	T	MB	■	■	■	■	✓	51					
	8164	L	T	F	■	■	■	■	✓	51					
	8165	L	T	UF	■	■	■	■	✓	51					
8211	S	A 20°	F	■	■	■	■	✓	45						
8233	XS	T 10°	UF	■	■	■	■	✓	44						
8234	XS	T 10°	UF	■	■	■	■	✓	45						
8237	XS	A 50°	UF	■	■	■	■	✓	46						
8247	S	A 45°	F	■	■	■	■	✓	46						
8248	S	A 45°	F	■	■	■	■	✓	47, 53						
7190	S	T	MB	■	■	■	■	✓	54						
7191	S	T	F	■	■	■	■	✓	54						
7280	S	A	F	■	■	■	■	✓	55						
7285	S	A	F	■	■	■	■	✓	55						
7290	S	A	MB	■	■	■	■	✓	56						
7291	S	A	F	■	■	■	■	✓	56						
7292	S	ED	F	■	■	■	■	✓	57						
7293	S	A	F	■	■	■	■	✓	56						
PLIERS	7490	S		SM	■	■	■	■		47, 57					
	7590	S		SM	■	■	■	■		48, 58					
	7890	M		SM	■	■	■	■		48, 58					
	7891	M		SE	■	■	■	■		48, 58					
	7892	M		SM	■	■	■	■		49, 59					
7893	S		SM	■	■	■	■		49, 59						

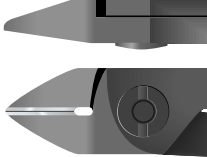
1 All part numbers as listed come standard with molded plastic handles and springs.

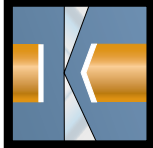
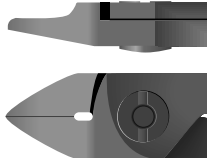
2 Type "J" edges for stripping and cutting insulated copper wire.

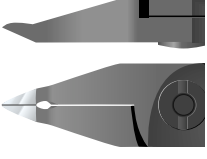
3 Max .16"/.4 mm springwire.

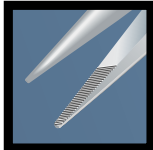
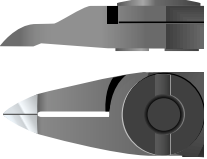
Capacity and Options

SIZE				ACTUAL SIZE	
XS	Extra Small				
S	Small				
M	Medium				
L	Large				
SHAPE					
O	Oval				
T	Tapered				
T&R	Tapered & Relieved				
A	Angle				
TP	Tip				
ED	End				
CUT OR SURFACE					
MB	Micro-Bevel				
F	Flush				
UF	Ultra-Flush				
SM	Smooth				
SE	Serrated				
HANDLE OPTIONS					
 RX	The ultimate in ergonomic and ESD safe handles.				
 CO	Standard handle shape in conductive material.				
 DS	Slip-on handle in dissipative material. (E.U. only)				
 HS	Traditional ergonomic handle shape in dissipative material. (U.S. only)				
To order handle options, add two letter prefix to part no. = Rx8130.					
LEAD CATCHER					
 L/C	Lead-Catcher available, add "S" suffix to part no. = 8130-S.				
					8130 XS / Extra Small
					8140 S / Small
					8150 M / Medium
					8160 L / Large
					7893 S / Small
					7890 M / Medium

Capacity and Options









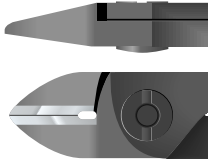

											CUTTING CAPACITY				
											COPPER WIRE				
PART NO. ¹	SIZE	SHAPE	CUT OR SURFACE	HANDLE OPTIONS				L / C	PAGE	GAUGE	38	24	18	15	12
				Rx	CO	DS	HS			INCH	.004	.02	.039	.059	.079
									MM	0.1	0.5	1.0	1.5	2.0	
CUTTERS	8130	XS	O	MB	■	■	■	■	✓	42, 50					
	8131	XS	O	F	■	■	■	■	✓	42, 50					
	8132	XS	O	UF	■	■	■	■	✓	42, 50					
	8140	S	O	MB	■	■	■	■	✓	42, 50					
	8141	S	O	F	■	■	■	■	✓	42, 50					
	8142	S	O	UF	■	■	■	■	✓	42, 50					
	8143	S	T	MB	■	■	■	■	✓	43, 51					
	8144	S	T	F	■	■	■	■	✓	43, 51					
	8145	S	T	UF	■	■	■	■	✓	43, 51					
	8146	S	T&R	MB	■	■	■	■	✓	43, 51					
	8147	S	T&R	F	■	■	■	■	✓	43, 51					
	8148	S	T&R	UF	■	■	■	■	✓	43, 51					
	8149	S	TP	F	■	■	■	■	✓	44, 52					
	8150	M	O	MB	■	■	■	■	✓	42, 50	3				
	8150 J ²	M	O	MB	■	■	■	■	✓	50	3				
	8151	M	O	F	■	■	■	■	✓	42, 50					
	8152	M	O	UF	■	■	■	■	✓	42, 50					
	8153	M	T	MB	■	■	■	■	✓	43, 51					
	8154	M	T	F	■	■	■	■	✓	43, 51					
	8155	M	T	UF	■	■	■	■	✓	43, 51					
	8156	M	T&R	MB	■	■	■	■	✓	51					
	8157	M	T&R	F	■	■	■	■	✓	51					
	8158	M	T&R	UF	■	■	■	■	✓	51					
	8160	L	O	MB	■	■	■	■	✓	42, 50					
	8160 J ²	L	O	MB	■	■	■	■	✓	50					
	8161	L	O	F	■	■	■	■	✓	42, 50					
	8162	L	O	UF	■	■	■	■	✓	42, 50					
	8163	L	T	MB	■	■	■	■	✓	51					
	8164	L	T	F	■	■	■	■	✓	51					
	8165	L	T	UF	■	■	■	■	✓	51					
8211	S	A 20°	F	■	■	■	■	✓	45						
8233	XS	T 10°	UF	■	■	■	■	✓	44						
8234	XS	T 10°	UF	■	■	■	■	✓	45						
8237	XS	A 50°	UF	■	■	■	■	✓	46						
8247	S	A 45°	F	■	■	■	■	✓	46						
8248	S	A 45°	F	■	■	■	■	✓	47, 53						
7190	S	T	MB	■	■	■	■	✓	54						
7191	S	T	F	■	■	■	■	✓	54						
7280	S	A	F	■	■	■	■	✓	55						
7285	S	A	F	■	■	■	■	✓	55						
7290	S	A	MB	■	■	■	■	✓	56						
7291	S	A	F	■	■	■	■	✓	56						
7292	S	ED	F	■	■	■	■	✓	57						
7293	S	A	F	■	■	■	■	✓	56						
PLIERS	7490	S		SM	■	■	■	■		47, 57					
	7590	S		SM	■	■	■	■		48, 58					
	7890	M		SM	■	■	■	■		48, 58					
	7891	M		SE	■	■	■	■		48, 58					
	7892	M		SM	■	■	■	■		49, 59					
	7893	S		SM	■	■	■	■		49, 59					

1 All part numbers as listed come standard with molded plastic handles and springs.

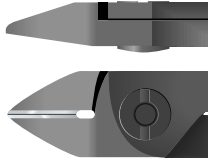
2 Type "J" edges for stripping and cutting insulated copper wire.

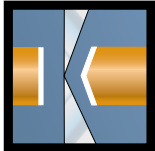
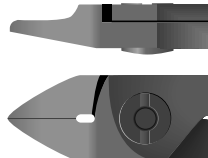
3 Max .16"/.4 mm springwire.

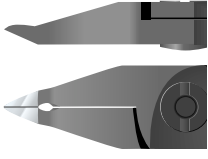
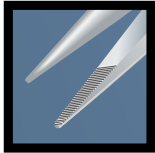
Capacity and Options

SIZE				ACTUAL SIZE	
XS	Extra Small				
S	Small				
M	Medium				
L	Large				
SHAPE					
O	Oval				
T	Tapered				
T&R	Tapered & Relieved				
A	Angle				
TP	Tip				
ED	End				
CUT OR SURFACE					
MB	Micro-Bevel				
F	Flush				
UF	Ultra-Flush				
SM	Smooth				
SE	Serrated				
HANDLE OPTIONS					
 RX	The ultimate in ergonomic and ESD safe handles.				
 CO	Standard handle shape in conductive material.				
 DS	Slip-on handle in dissipative material. (E.U. only)				
 HS	Traditional ergonomic handle shape in dissipative material. (U.S. only)				
To order handle options, add two letter prefix to part no. = Rx8130.					
LEAD CATCHER					
 L/C	Lead-Catcher available, add "S" suffix to part no. = 8130-S.				

8130
XS / Extra Small



8140
S / Small



8150
M / Medium



8160
L / Large



7893
S / Small



7890
M / Medium



Capacity and Options















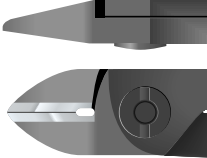

												CUTTING CAPACITY				
												COPPER WIRE				
PART NO. ¹	SIZE	SHAPE	CUT OR SURFACE	HANDLE OPTIONS				L / C	PAGE	GAUGE	38	24	18	15	12	
				Rx	CO	DS	HS			INCH	.004	.02	.039	.059	.079	
									MM	0.1	0.5	1.0	1.5	2.0		
CUTTERS	8130	XS	O	MB	■	■	■	■	✓	42, 50						
	8131	XS	O	F	■	■	■	■	✓	42, 50						
	8132	XS	O	UF	■	■	■	■	✓	42, 50						
	8140	S	O	MB	■	■	■	■	✓	42, 50						
	8141	S	O	F	■	■	■	■	✓	42, 50						
	8142	S	O	UF	■	■	■	■	✓	42, 50						
	8143	S	T	MB	■	■	■	■	✓	43, 51						
	8144	S	T	F	■	■	■	■	✓	43, 51						
	8145	S	T	UF	■	■	■	■	✓	43, 51						
	8146	S	T&R	MB	■	■	■	■	✓	43, 51						
	8147	S	T&R	F	■	■	■	■	✓	43, 51						
	8148	S	T&R	UF	■	■	■	■	✓	43, 51						
	8149	S	TP	F	■	■	■	■	✓	44, 52						
	8150	M	O	MB	■	■	■	■	✓	42, 50	3					
	8150 J ²	M	O	MB	■	■	■	■	✓	50	3					
	8151	M	O	F	■	■	■	■	✓	42, 50						
	8152	M	O	UF	■	■	■	■	✓	42, 50						
	8153	M	T	MB	■	■	■	■	✓	43, 51						
	8154	M	T	F	■	■	■	■	✓	43, 51						
	8155	M	T	UF	■	■	■	■	✓	43, 51						
	8156	M	T&R	MB	■	■	■	■	✓	51						
	8157	M	T&R	F	■	■	■	■	✓	51						
	8158	M	T&R	UF	■	■	■	■	✓	51						
	8160	L	O	MB	■	■	■	■	✓	42, 50						
	8160 J ²	L	O	MB	■	■	■	■	✓	50						
	8161	L	O	F	■	■	■	■	✓	42, 50						
	8162	L	O	UF	■	■	■	■	✓	42, 50						
	8163	L	T	MB	■	■	■	■	✓	51						
	8164	L	T	F	■	■	■	■	✓	51						
	8165	L	T	UF	■	■	■	■	✓	51						
8211	S	A 20°	F	■	■	■	■	✓	45							
8233	XS	T 10°	UF	■	■	■	■	✓	44							
8234	XS	T 10°	UF	■	■	■	■	✓	45							
8237	XS	A 50°	UF	■	■	■	■	✓	46							
8247	S	A 45°	F	■	■	■	■	✓	46							
8248	S	A 45°	F	■	■	■	■	✓	47, 53							
7190	S	T	MB	■	■	■	■	✓	54							
7191	S	T	F	■	■	■	■	✓	54							
7280	S	A	F	■	■	■	■	✓	55							
7285	S	A	F	■	■	■	■	✓	55							
7290	S	A	MB	■	■	■	■	✓	56							
7291	S	A	F	■	■	■	■	✓	56							
7292	S	ED	F	■	■	■	■	✓	57							
7293	S	A	F	■	■	■	■	✓	56							
PLIERS	7490	S		SM	■	■	■	■		47, 57						
	7590	S		SM	■	■	■	■		48, 58						
	7890	M		SM	■	■	■	■		48, 58						
	7891	M		SE	■	■	■	■		48, 58						
	7892	M		SM	■	■	■	■		49, 59						
7893	S		SM	■	■	■	■		49, 59							

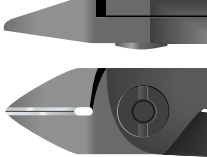
1 All part numbers as listed come standard with molded plastic handles and springs.

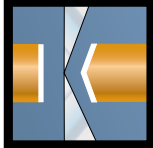
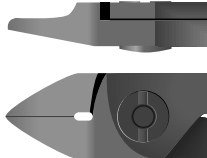
2 Type "J" edges for stripping and cutting insulated copper wire.

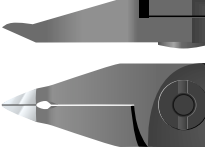
3 Max .16"/.4 mm springwire.

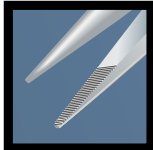
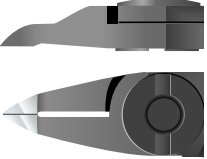
Capacity and Options

SIZE				ACTUAL SIZE	
XS	Extra Small				
S	Small				
M	Medium				
L	Large				
SHAPE					
O	Oval				
T	Tapered				
T&R	Tapered & Relieved				
A	Angle				
TP	Tip				
ED	End				
CUT OR SURFACE					
MB	Micro-Bevel				
F	Flush				
UF	Ultra-Flush				
SM	Smooth				
SE	Serrated				
HANDLE OPTIONS					
 RX	The ultimate in ergonomic and ESD safe handles.				
 CO	Standard handle shape in conductive material.				
 DS	Slip-on handle in dissipative material. (E.U. only)				
 HS	Traditional ergonomic handle shape in dissipative material. (U.S. only)				
To order handle options, add two letter prefix to part no. = Rx8130.					
LEAD CATCHER					
 L/C	Lead-Catcher available, add "S" suffix to part no. = 8130-S.				
					8130 XS / Extra Small
					8140 S / Small
					8150 M / Medium
					8160 L / Large
					7893 S / Small
					7890 M / Medium





Lindstrom Precision Tools – advanced tools
for assembly, rework and repair.

REPRESENTED BY:

DISTRIBUTED BY:

**For more information on the benefits of Lindstrom products,
or details on your nearest Lindstrom Distributor,
visit our homepage at**

www.lindstromtools.com