

Width of 1.9mm contributes to thinner product designs and greater mounting efficiency



TACT Switch™

Sharp Feeling

Soft Feeling

Snap-In Type

Surface Mount Type

Radial Type

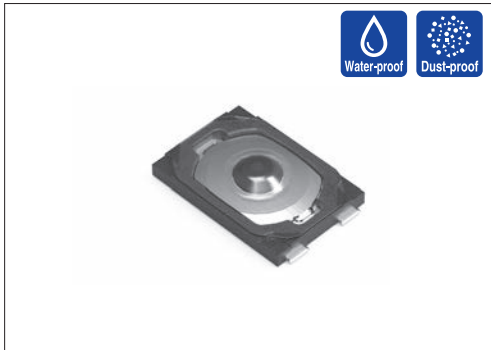

■ Typical Specifications

Items	Specifications
Rating (max.)	50mA 12V DC
Rating (min.)	10μA 1V DC
Initial contact resistance	500mΩ max.
Travel (mm)	0.12
Protective structure ※	IP67 equivalent

■ Product Line

Product No.	Operating force	Operating direction	Operating life (5mA 5V DC)	Minimum order unit (pcs.)	
				Japan	Export
SKSVCAE010	1.6N	Top push	300,000 cycles	20,000	20,000
SKSVCE010	2.2N		100,000 cycles		

■ Packing Specifications

Taping

Number of packages (pcs.)			Tape width (mm)	Export package measurements (mm)
1 reel	1 case / Japan	1 case / export packing		
20,000	200,000	200,000	12	395×395×205

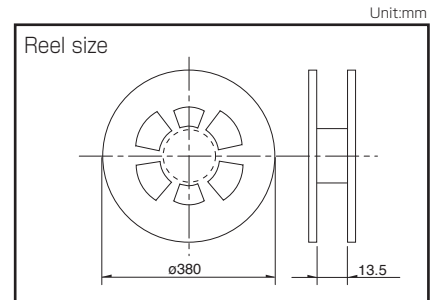

Note

For reels of 330mm diameter, please inquire.

■ Dimensions





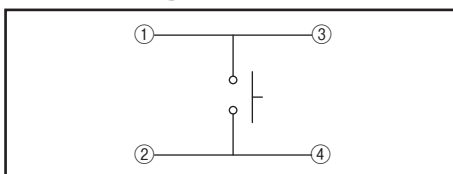













Style	PC board mounting hole and land dimensions (Viewed from switch mounting face)

■ Circuit Diagram



※ Assumes the switch is left alone without being operated. Under the specified conditions, dust and water ingress with a significant impact on the switch's on-off function is prevented. IP67 dust and water resistance is guaranteed for the switch alone and performance may not be guaranteed depending on the mounting conditions and usage.

Refer to P.265 for soldering conditions.

Type		Sharp Feeling Type								
		Surface Mount								
Series		SKSD	SKRN	SKTA	SKSV	SKSW	SKSF	SKSM	SKTK	SKSG
Photo										
Features		Double action		Compact size Low-profile					Long life	High operation force Compact size
Water-proof		—	—	●	●	●	—	●	●	—
Dust-proof		—	—	●	●	●	—	●	●	—
IP standard		—	—	67 equivalency	67 equivalency	67 equivalency 68 equivalent in some cases	—	67 equivalency	67 equivalency	—
Operating direction	Top push	●	●	●	●	●	●	●	●	●
	Side push	—	—	—	—	—	—	—	—	—
Dimensions (mm)	W	4.1	□6	2.6	2.8	3	2.8	3.4	5.9	3
	D	3.9		1.6	1.9	2	2.4	2.9	4	2.7
	H	0.6	0.9	0.53	0.55	0.6	0.65	0.7	0.78	1.4
Operation force coverage	1N max.	See the relevant pages for respective product descriptions		↕	↕	↕	↕	↕	↕	↕
	1N to 2N									
	2N to 3N									
	3N to 4N									
4N to 5N										
Travel (mm)		See the relevant pages for respective product descriptions		0.11	0.12	0.13	0.1		0.25	0.12
Ground terminal		●	●	—	—	—	—	—	—	○
Operating temperature range		-40°C to +90°C			-30°C to +85°C					
Automotive use		—	—	—	—	—	—	—	—	●
Life Cycle										
Electrical performance	Rating (max.) (Resistive load)	50mA 12V DC								
	Rating (min.) (Resistive load)	10μA 1V DC								
	Insulation resistance	100MΩ min. 100V DC 1min.						50MΩ min. 100V DC 1min.	100MΩ min. 100V DC 1min.	
	Voltage proof	100V AC 1min.	250V AC 1min.	100V AC 1min.						
Durability	Vibration	10 to 55 to 10Hz/min., the amplitude is 1.5mm for all the frequencies, in the 3 direction of X, Y and Z for 2 hours respectively								
	Lifetime	Shall be in accordance with individual specifications.								
Environmental performance	Cold	-40°C 96h								
	Dry heat	90°C 96h								
	Damp heat	60°C, 90 to 95%RH 96h								
Page		219	220	221	222	223	225	226	227	228

W : Width. The most outer dimension excluding terminal portion.

D : Depth. The most outer dimension excluding terminal portion.

H : Height. The minimum dimension if there are variances.

TACT Switch™ Soldering Conditions	265
TACT Switch™ Cautions	266

Notes

- The automotive operating temperature range to be individually discussed upon request.
- Indicates applicability to all products in the series, while ○ indicates applicability to some products in the series.

Condition for Reflow

Available for Surface Mount Type.

1. Temperature measurement: Thermocouple ϕ 0.1 to 0.2 CA (K) or CC (T) at solder joints (copper foil surface).
A heat resistive tape should be used to fix thermocouple.
2. Temperature profile

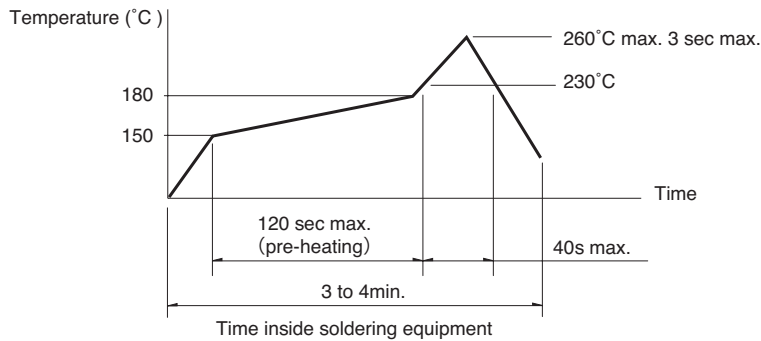

Notes

1. The above temperature shall be measured of the top of switch. There are cases where the PC board's temperature greatly differs from that of the switch, depending on the material, size, thickness of PC boards and others.
The above-stated conditions shall also apply to switch surface temperatures.
2. Soldering conditions differ depending on reflow soldering machines.
Prior verification of soldering condition is highly recommended.

Conditions for Auto-dip

Available for Snap-in Type and Radial Type.

Items	Condition
Flux built-up	Mounting surface should not be exposed to flux
Preheating temperature	Ambient temperature of the soldered surface of PC board. 100°C max.
Preheating time	60s max.
Soldering temperature	260°C max.
Duration of immersion	5s max.
Number of soldering	2times max.

SKHH, SKPD Series

Items	Condition
Flux built-up	Mounting surface should not be exposed to flux
Preheating temperature	Ambient temperature of the soldered surface of PC board. 110°C max.
Preheating time	60s max.
Soldering temperature	260°C max.
Duration of immersion	5s max.
Number of soldering	2times max.

SKQJ, SKQK, SKEG Series

Items	Condition
Flux built-up	Mounting surface should not be exposed to flux
Preheating temperature	Ambient temperature of the soldered surface of PC board. 100°C max.
Preheating time	45s max.
Soldering temperature	255°C max.
Duration of immersion	5s max.
Number of soldering	2times max.

Manual Soldering

Items	Condition
Soldering temperature	350°C max.
Duration of soldering	3s max.
Capacity of soldering iron	60W max.

SKHH, SKHW, SKRG, SKPD Series

Items	Condition
Soldering temperature	360°C max.
Duration of soldering	3s max.
Capacity of soldering iron	60W max.

SKTD, SKTG, SKQJ, SKQK, SKEG Series

Items	Condition
Soldering temperature	350°C max.
Duration of soldering	3s max.
Capacity of soldering iron	20W max.

Notes

1. Prevent flux penetration from the top side of the TACT Switch™.
2. Switch terminals and a PC board should not be coated with flux prior to soldering.
3. The second soldering should be done after the switch is stable with normal temperature.
4. Use the flux with a specific gravity of min 0.81.
(EC-19S-8 by TAMURA Corporation, or equivalents.)