

PRODUCT NUMBER  
10106814-0XX0X2LF



10106814-0XX0X2LF  
HERMAPHRODITIC CONNECTOR  
ASSEMBLY



PRINTED  
CIRCUIT  
BOARD

CONNECTOR ORIENTATION  
FEATURE  
SEE PCB LAYOUT ON PAGE 5

10106814-0XX0X2LF  
HERMAPHRODITIC CONNECTOR  
ASSEMBLY

CONNECTOR ORIENTATION  
FEATURE  
SEE PCB LAYOUT ON PAGE 5



Copyright FCI.

spec ref	---	dr	Stu Stoner	2010/11/22	projection	mm	size	A2	scale	20:1	
tolerance std	ASME Y14.5	eng	Andy Lu	2015/07/15		mm	ecn no	ELX-DG-21387-1			
TOLERANCES UNLESS OTHERWISE SPECIFIED		chr	-	rel level				Released			
surface	✓	appr	Pei-Ming Zheng	2015/07/15	product family	MezzoStack	rel level	Released			
ASME Y14.5	linear	0.X	±0.3		title HERMAPHRODITIC CONNECTOR, SHORT STYLE 20-90 POS, 0.5MM CTR, 4-7MM STACK HT	dwg no 10106814	rev D	www.fci.com			
		0.XX	±0.15					cat. no.	-	Product - Customer Drw	sheet 1 of 8
		0.XXX	±0.05								
ASME Y14.5	angular	0°	±3°								

PDS: Rev :D

STATUS:Released

Printed: Jul 16, 2015



POSITION 4  
 POSITION 2  
 SEE CONNECTOR  
 MATING TABLE

CONNECTOR ORIENTATION  
 FEATURE

POSITION 1  
 SEE CONNECTOR  
 MATING TABLE

POSITION 3

5.1

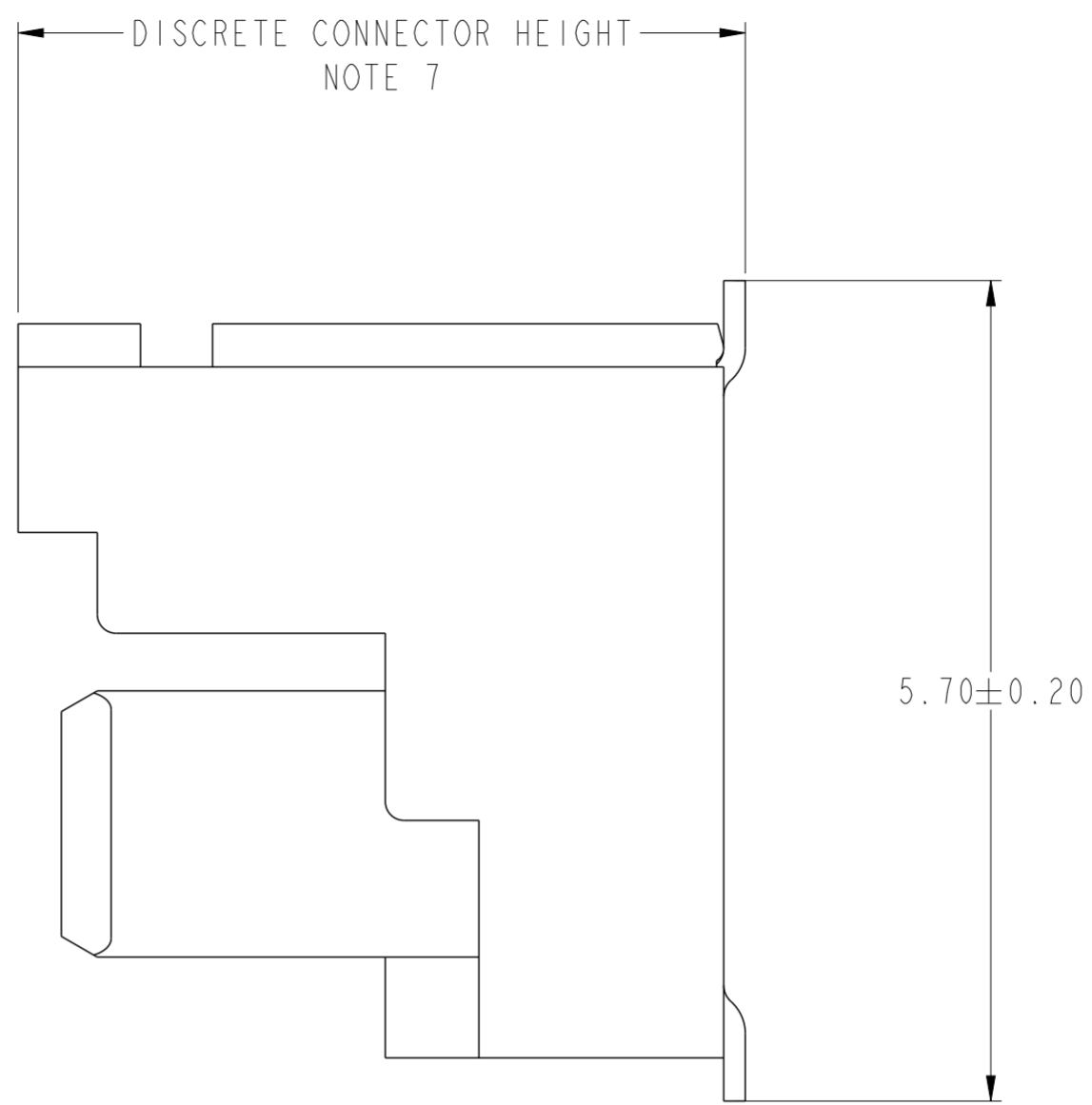

HERMAPHRODITIC CONNECTOR MATING	
CONNECTOR POSITION	MATES WITH CONNECTOR POSITION
1	2
3	4
5	6
7	8
9	10
ETC.	

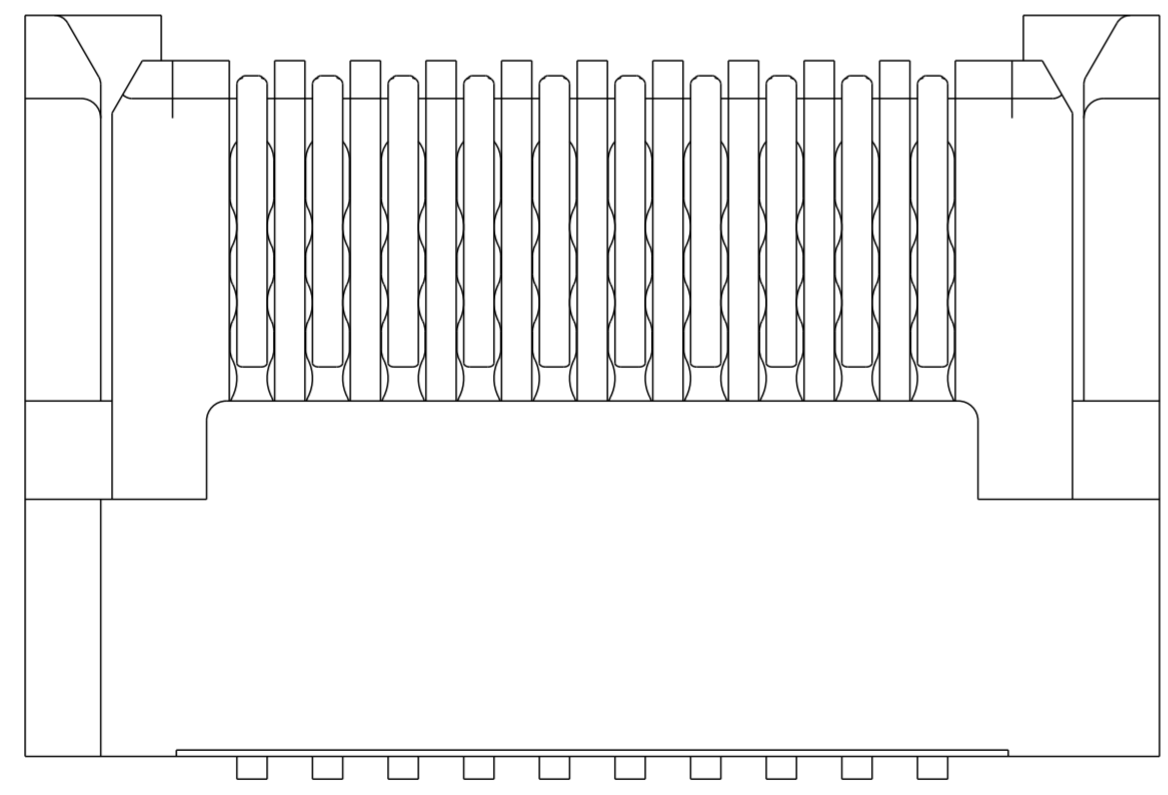

10106814-024002LF SHOWN  
 WITHOUT STANDARD PICK-UP CAP

Copyright FCI. FCI

spec ref	---	dr	Stu Stoner	2010/11/22	projection	mm	size	A2	scale	20:1
tolerance std	ASME Y14.5	eng	Andy Lu	2015/07/15			ecn no	ELX-DG-21387-1		
TOLERANCES UNLESS OTHERWISE SPECIFIED		chr	-	app			Pei-Ming Zheng	2015/07/15	product family	MezzoStack
surface	✓	linear	0.X	±0.3		title HERMAPHRODITIC CONNECTOR, SHORT STYLE 20-90 POS, 0.5MM CTR, 4-7MM STACK HT	rel level	Released		
			0.XX	±0.15			dwg no	10106814		
		angular	0°	±3°			cat. no.	Product - Customer Drw		
ASME Y14.5		www.fci.com		sheet 2 of 8		rev		D		

PDS: Rev :D

STATUS:Released

Printed: Jul 16, 2015

	1	2	3	4	5	6	7	8
	PRODUCT NUMBER	NUMBER OF POSITIONS	DIM A	DIM B	DISCRETE CONNECTOR HEIGHT NOTE 9	PRACTICAL CONNECTOR HEIGHT NOTE 8	STATUS	
A	10106814-021002LF	20	7.5	4.5	3.55	2.00	RELEASED	
	10106814-031002LF	30	10.0	7.0				
	10106814-041002LF	40	12.5	9.5				
	10106814-051002LF	50	15.0	12.0				
	10106814-061002LF	60	17.5	14.5				
	10106814-071002LF	70	20.0	17.0	4.05	2.50	UN-RELEASED	
	10106814-022002LF	20	7.5	4.5				
	10106814-032002LF	30	10.0	7.0				
	10106814-042002LF	40	12.5	9.5				
	10106814-052002LF	50	15.0	12.0				
B	10106814-062002LF	60	17.5	14.5	4.55	3.00	RELEASED	
	10106814-072002LF	70	20.0	17.0				
	10106814-023002LF	20	7.5	4.5				
	10106814-033002LF	30	10.0	7.0				
	10106814-043002LF	40	12.5	9.5				
	10106814-053002LF	50	15.0	12.0	5.05	3.50	RELEASED	
	10106814-063002LF	60	17.5	14.5				
	10106814-073002LF	70	20.0	17.0				
	10106814-083002LF	80	22.5	19.5				
	10106814-093002LF	90	25.0	22.0				
C	10106814-093012LF	90	25.0	22.0	5.05	3.50	RELEASED	
	10106814-024002LF	20	7.5	4.5				
	10106814-034002LF	30	10.0	7.0				
	10106814-044002LF	40	12.5	9.5				
	10106814-054002LF	50	15.0	12.0				
	10106814-064002LF	60	17.5	14.5	5.05	3.50	RELEASED	
	10106814-074002LF	70	20.0	17.0				

**0.5 BTB HERMAPHRODITIC CONNECTOR ASSEMBLY PART NUMBER SCHEME**  
**EXAMPLE: 10106814-XX X X X 2 LF**

NUMBER OF POSITIONS
02 = 20 POS
03 = 30 POS
04 = 40 POS
05 = 50 POS
06 = 60 POS
07 = 70 POS
08 = 80 POS
09 = 90 POS

PRACTICAL CONNECTOR HEIGHT NOTE 8
1 = 2.0MM
2 = 2.5MM
3 = 3.0MM
4 = 3.5MM

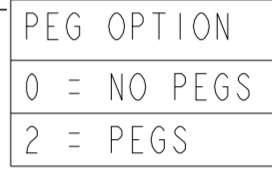
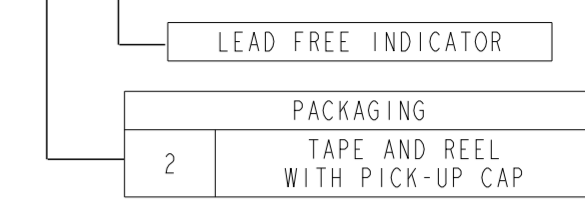

Copyright FCI.

spec ref	---	dr	Stu Stoner	2010/1/22	projection	mm	size	A2	scale	10:1
tolerance std	ASME Y14.5	eng	Andy Lu	2015/07/15	chr	-	ecn no	ELX-DG-21387-1	rel level	Released
surface	✓	appr	Pei-Ming Zheng	2015/07/15	product family	MezzoStak	cat. no.	10106814	rev	D
ASME Y14.5	linear	0.X	±0.3	0.XX	±0.15	0.XXX	±0.05	angular	0°	±3°
		www.fci.com		title		HERMAPHRODITIC CONNECTOR, SHORT STYLE		20-90 POS, 0.5MM CTR, 4-7MM STACK HT		Product - Customer Drw

PDS: Rev :D

STATUS: Released

Printed: Jul 16, 2015



10106814-024002LF SHOWN  
WITH STANDARD PICK-UP CAP

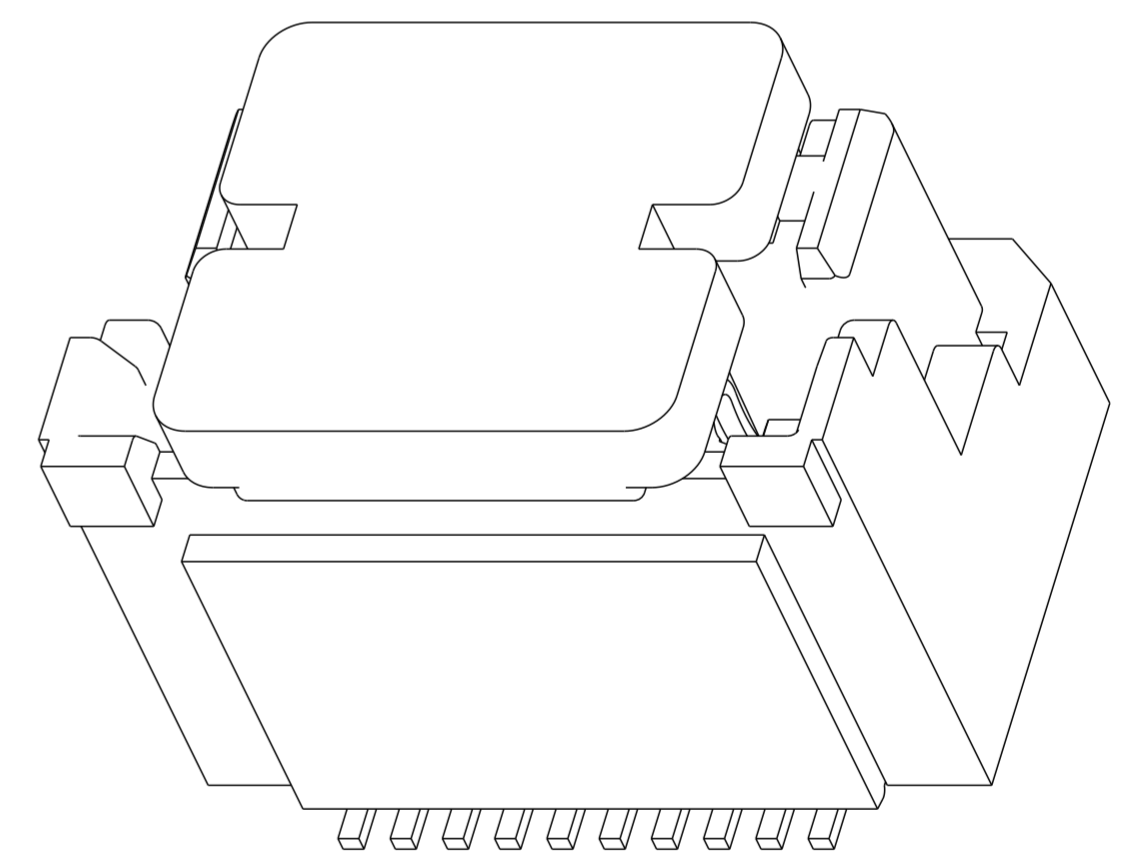
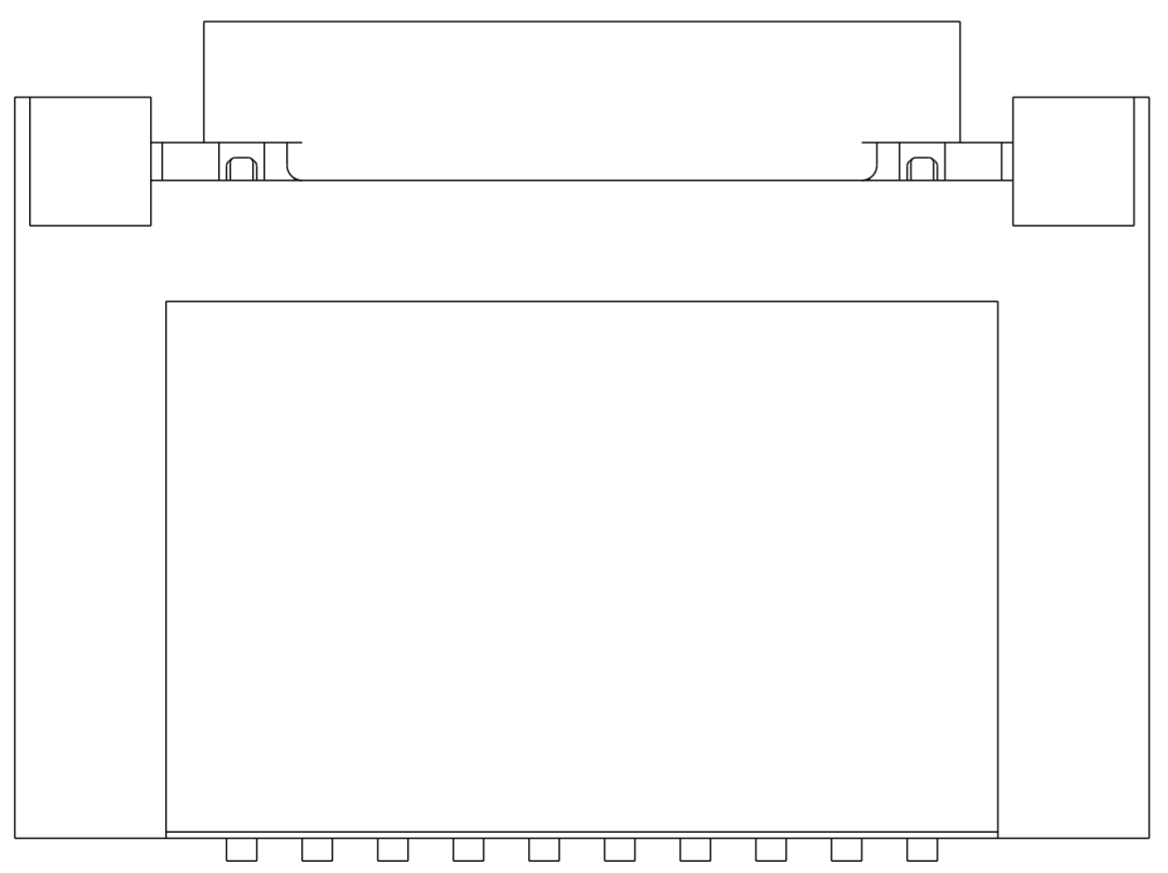

Copyright FCI.  
**FCI**

spec ref	---	dr	Stu Stoner	2010/1/22	projection	mm	size	A2	scale	20:1
tolerance std	ASME Y14.5	eng	Andy Lu	2015/07/15			ecn no	ELX-DG-21387-1		
TOLERANCES UNLESS OTHERWISE SPECIFIED		chr	-	appr			Pei-Ming Zheng	2015/07/15	product family	MezzoStak
surface		linear	0.X	±0.3		title HERMAPHRODITIC CONNECTOR, SHORT STYLE 20-90 POS, 0.5MM CTR, 4-7MM STACK HT	dwg no 10106814	rev D		
			0.XX	±0.15						
			0.XXX	±0.05						
ASME Y14.5		angular	0°	±3°	www.fci.com	cat. no.	-	Product - Customer Drw	sheet 4 of 8	

PDS: Rev :D

STATUS:Released

Printed: Jul 16, 2015

PRODUCT NUMBER	NUMBER OF POSITIONS	DIM A	DIM B	DIM C	PEGS STATUS	DIM_D
10106814-02X002LF	20	2.25	4.50	7.50	NO	N/A
10106814-03X002LF	30	3.50	7.00	10.00	NO	N/A
10106814-04X002LF	40	4.75	9.50	12.50	NO	N/A
10106814-05X002LF	50	6.00	12.00	15.00	NO	N/A
10106814-06X002LF	60	7.25	14.50	17.50	NO	N/A
10106814-07X002LF	70	8.50	17.00	20.00	NO	N/A
10106814-08X002LF	80	9.75	19.50	22.50	NO	N/A
10106814-09X002LF	90	11.00	22.00	25.00	NO	N/A
10106814-08X202LF	80	9.75	19.50	22.50	YES	22.00
10106814-09X202LF	90	11.00	22.00	25.00	YES	24.50

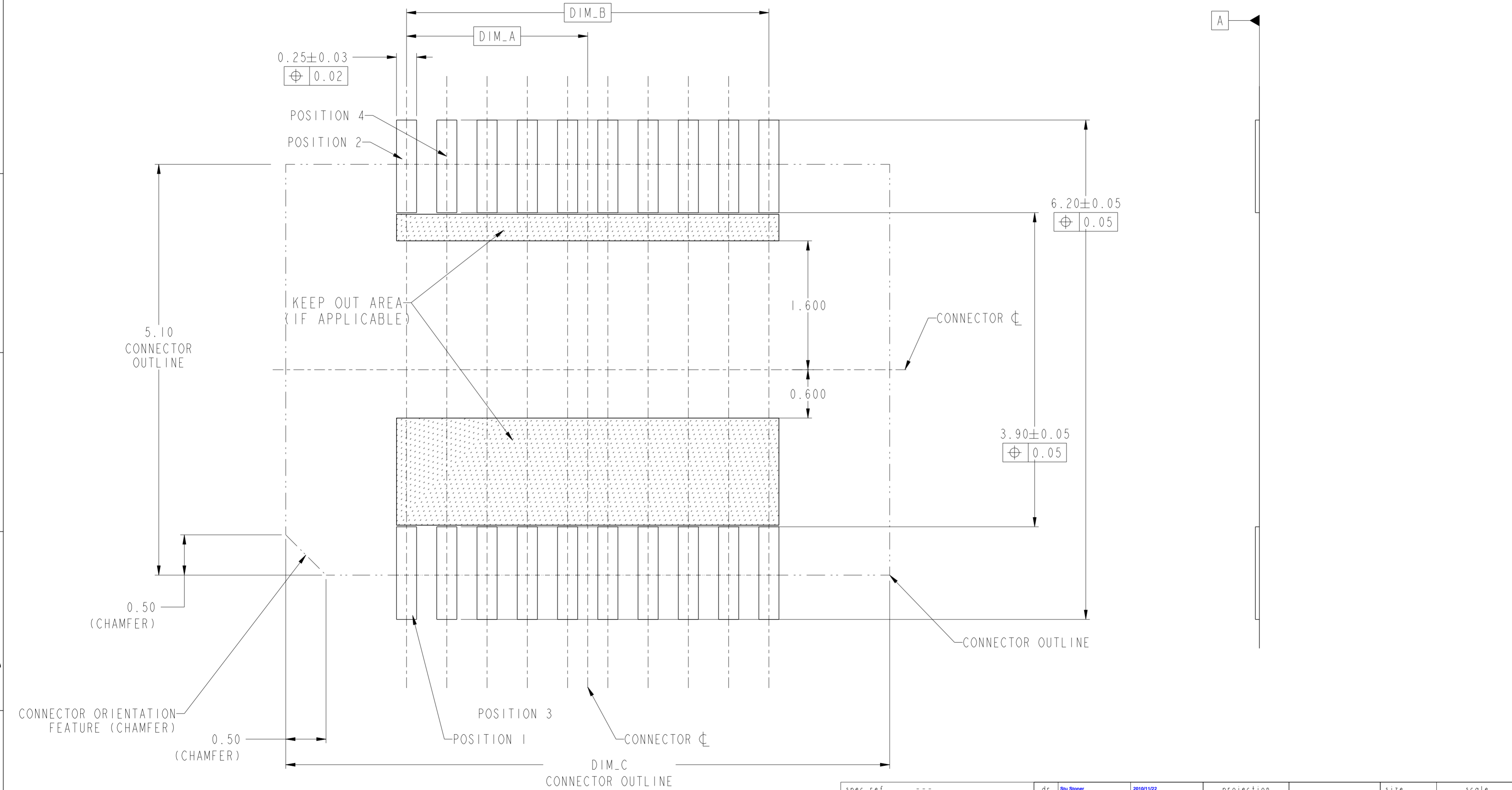

**OPTION 1 - SPACE OPTIMIZED FOOTPRINT**  
**SEE TABLE FOR CONNECTOR LAYOUT DIMENSIONS**  
**SEE NOTE 8 FOR STENCIL CREATION GUIDELINES**

spec ref	---	dr	Stu Stoner	2010/11/22	projection	mm	size	A2	scale	30:1	
tolerance std	ASME Y14.5	eng	Andy Lu	2015/07/15	chr	-	ecn no	ELX-DG-21387-1			
TOLERANCES UNLESS OTHERWISE SPECIFIED		app	Pei-Ming Zheng	2015/07/15	product family	MezzoStak	rel level	Released			
surface	linear	0.X	±0.3		title		HERMAPHRODITIC CONNECTOR, SHORT STYLE	dwg no	10106814	rev	D
		0.XX	±0.15		title		20-90 POS, 0.5MM CTR, 4-7MM STACK HT				
		0.XXX	±0.05		cat. no.		Product - Customer Drw	sheet 5 of 8			
ASME Y14.5	angular	0°	±3°	www.fci.com							

PRODUCT NUMBER	NUMBER OF POSITIONS	DIM A	DIM B	DIM C	PEGS STATUS	DIM_D
10106814-02X002LF	20	2.25	4.50	7.50	NO	N/A
10106814-03X002LF	30	3.50	7.00	10.00	NO	N/A
10106814-04X002LF	40	4.75	9.50	12.50	NO	N/A
10106814-05X002LF	50	6.00	12.00	15.00	NO	N/A
10106814-06X002LF	60	7.25	14.50	17.50	NO	N/A
10106814-07X002LF	70	8.50	17.00	20.00	NO	N/A
10106814-08X002LF	80	9.75	19.50	22.50	NO	N/A
10106814-09X0X2LF	90	11.00	22.00	25.00	NO	N/A
10106814-08X202LF	80	9.75	19.50	22.50	YES	22.00
10106814-09X202LF	90	11.00	22.00	25.00	YES	24.50

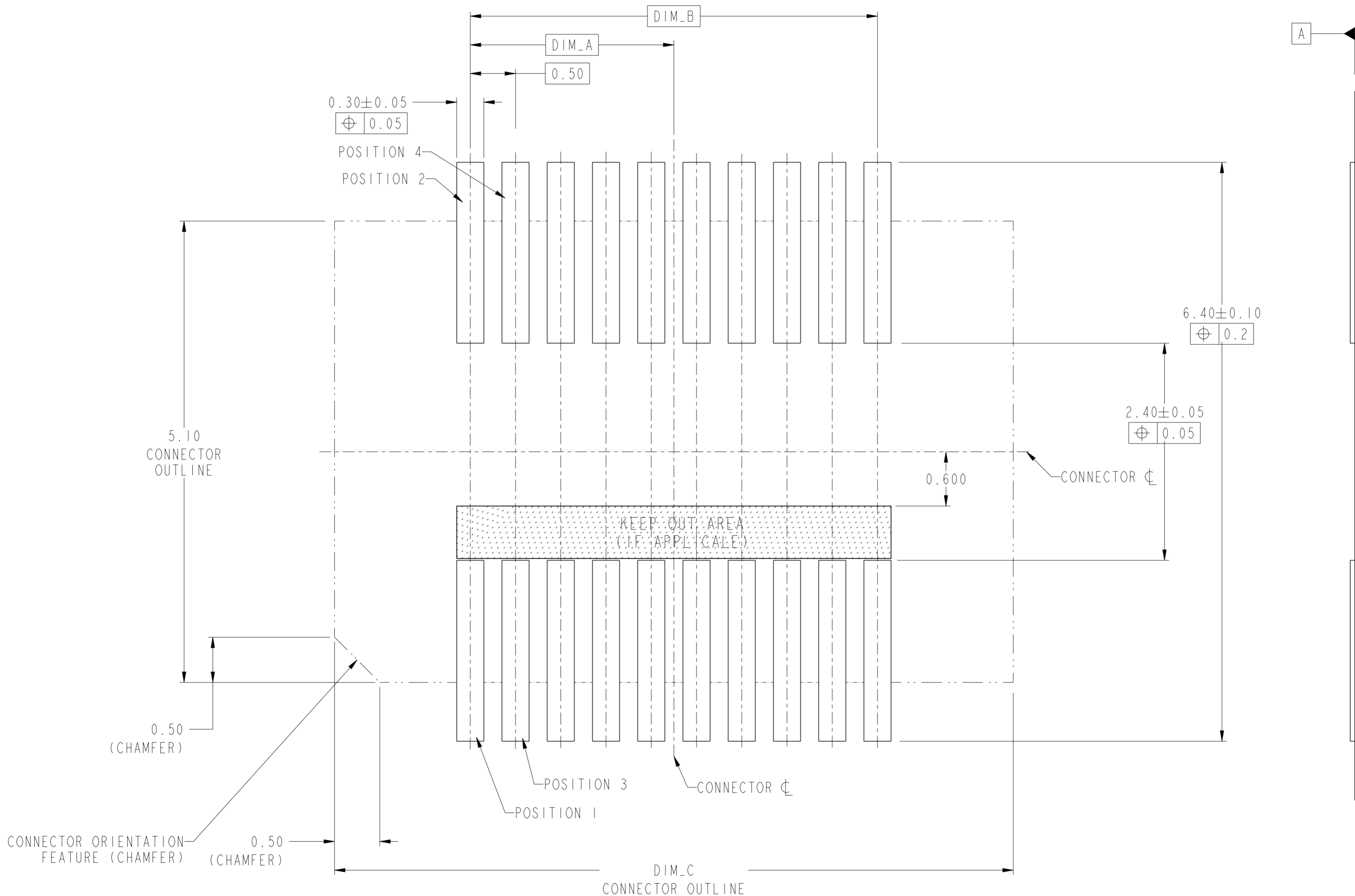

**OPTION 2 - FOOTPRINT**  
**SEE TABLE FOR CONNECTOR LAYOUT DIMENSIONS**  
**SEE NOTE 8 FOR STENCIL CREATION GUIDELINES**

spec ref	---	dr	Stu Stoner	2010/1/22	projection	mm	size	A2	scale	10:1
tolerance std	ASME Y14.5	eng	Andy Lu	2015/07/15	chr	-	ecn no	ELX-DG-21387-1	rel level	Released
surface	linear	appr	Pei-Ming Zheng	2015/07/15	product family	MezzoStak	title	HERMAPHRODITIC CONNECTOR, SHORT STYLE	div no	10106814
ASME Y14.5	angular	0°	±3°	www.fci.com	cat. no.	-	Product - Customer Drw	sheet 6 of 8	rev	D

10106814-0932X2LF SHOWN



SCALE 15:1

2X (Ø0.50) PEGS FEATURE  
ONLY FOR 10106814-083202LF  
AND 10106814-093202LF

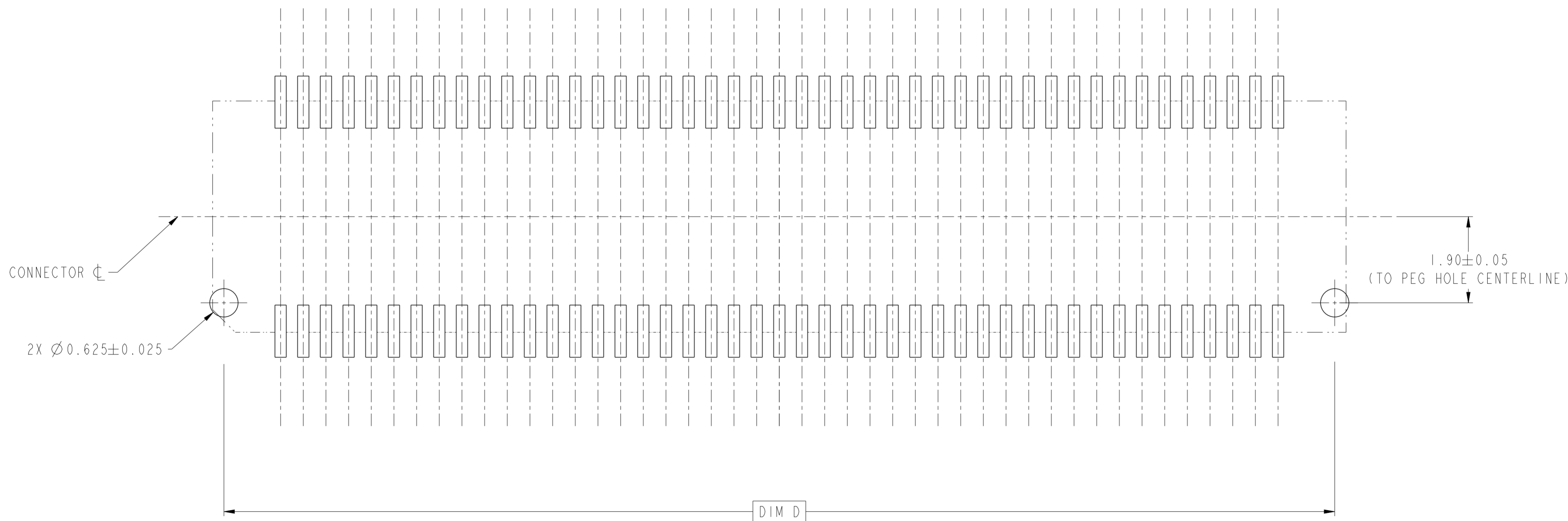

PCB LAYOUT FOR 10106814-083202LF AND 10106814-093202LF  
OTHER DIMENSIONS, SEE SHEET 5 AND 6

SCALE 15:1





spec ref	---	dr	Stu Stoner	2010/11/22	projection	mm	size	A2	scale	10:1
tolerance std	ASME Y14.5	eng	Andy Lu	2015/07/15			ecn no	ELX-DG-21387-1		
TOLERANCES UNLESS OTHERWISE SPECIFIED		chr	-	rel level			Released			
		appr	Pei-Ming Zheng	2015/07/15			product family	MezzoStak		
surface	✓	linear	0.X	±0.3		title HERMAPHRODITIC CONNECTOR, SHORT STYLE 20-90 POS, 0.5MM CTR, 4-7MM STACK HT	dwg no	10106814		
			0.XX	±0.15			rev	D		
		angular	0°	±3°			www.fci.com	cat. no.	-	Product - Customer Drw



NOTES

- 1 - MATERIAL:  
HOUSING - HIGH-TEMPERATURE THERMOPLASTIC, UL94-V0, COLOR: BLACK  
CONTACTS: COPPER ALLOY  
CONTACT PLATING:  
SEPARABLE INTERFACE: PERFORMANCE-BASED PLATING, QUALIFIED TO MEET THE REQUIREMENTS OF FCI PRODUCT SPECIFICATION.  
SOLDER TAILS: GOLD FLASH.
- 2 - RECOMMENDED LEAD FREE SOLDER PASTE THICKNESS 150µm.
- 3 - THE HOUSING WILL WITHSTAND EXPOSURE TO 260°C PEAK TEMPERATURE FOR 30 SECONDS IN A CONVECTION INFRA RED OR VAPOR PHASE REFLOW OVEN.
- 4 - THIS PRODUCT MEETS EUROPEAN UNION DIRECTIVES AND OTHER COUNTRY REGULATION AS DESCRIBED IN GS-22-008
- 5 - PACKAGING TAPE AND REEL. PACKAGING SPECIFICATION GS-14-1320, PRODUCT SPECIFICATION GS-12-1322.
- 6 - PRACTICAL CONNECTOR HEIGHT AS SPECIFIED IN THE TABLE IS NOT THE DIMENSIONAL HEIGHT OF THE CONNECTOR BUT THE HEIGHT AS IT PERTAINS TO TOTAL STACK HEIGHT. AN EXAMPLE IS A CONNECTOR WITH A 2.5MM PRACTICAL CONNECTOR HEIGHT, WHEN MATED TO ITSELF WILL RESULTING IN A BOARD TO BOARD STACK HEIGHT OF 5MM.
- 7 - DISCRETE CONNECTOR HEIGHT AS SHOWN IN THE TABLE IS THE ACTUAL DIMENSIONAL CONNECTOR HEIGHT. ALSO SEE INFORMATION ON PRACTICAL HEIGHT IN NOTE 6.
- 8 - REFER TO IPC 7525-A FOR STENCIL CREATION.

Copyright FCI. FCI

spec ref	---	dr	Stu Stoner	2010/1/22	projection	mm	size	A2	scale	20:1	
tolerance std	ASME Y14.5	eng	Andy Lu	2015/07/15			ecn no	ELX-DG-21387-1			
TOLERANCES UNLESS OTHERWISE SPECIFIED		chr	-	appr			Pei-Ming Zheng	2015/07/15	product family	MezzoStak	rel level
surface		linear	0.X	±0.3		title HERMAPHRODITIC CONNECTOR, SHORT STYLE 20-90 POS, 0.5MM CTR, 4-7MM STACK HT	div no 10106814	rev D			
			0.XX	±0.15							
			0.XXX	±0.05							
ASME Y14.5	angular	0°	±3°	www.fci.com	cat. no.	-	Product - Customer Drw	sheet 8 of 8			