

Data sheet | Item number: 750-493

3-Phase Power Measurement; 480 VAC, 1 A; light gray

www.wago.com/750-493

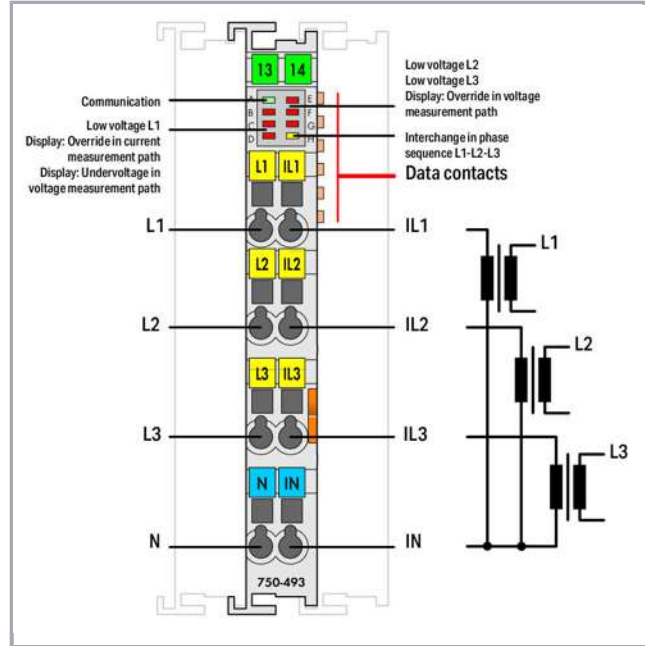

RoHS Compliant

BOMcheck.net

Color: ■

Subject to changes. Please also observe the further product documentation!

WAGO Kontakttechnik GmbH & Co. KG
Hansastr. 27
32423 Minden
Phone: +49571 887-0 | Fax: +49571 887-169
Email: info.de@wago.com | Web: www.wago.com

Do you have any questions about our products?
We are always happy to take your call at +49 (571) 887-44222.

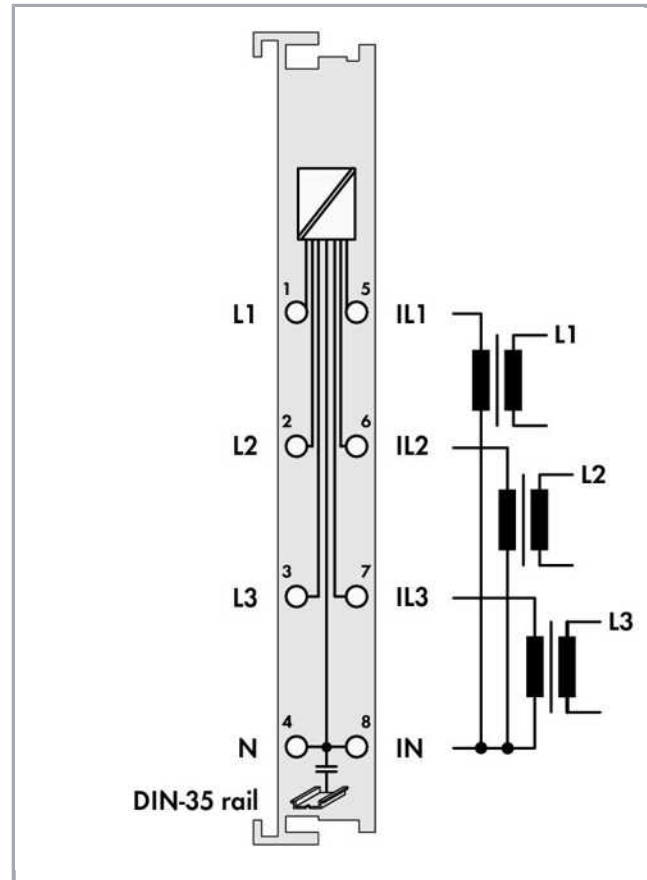
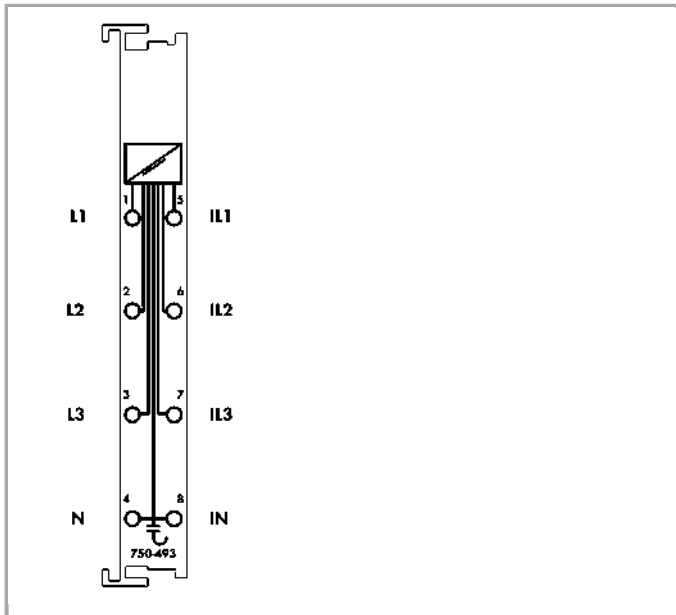

Item description

The 750-493 3-Phase Power Measurement Module measures the electrical data in a three-phase supply network.

The voltage is measured via network connection to L1, L2, L3 and N.

The current of the three phases is fed to IL1, IL2, IL3 and IN via current transformers.

The 750-493 Module transmits the root mean square values into the process image without requiring high computing power from the controller. For each phase, the effective power (P) and the energy consumption (W) are calculated by the module using the root mean square values for all measured voltages (V) and currents (I). For example, both the apparent power (S) and phase shift angle (ϕ) can be easily derived from these values.

Therefore, the 750-493 Module provides comprehensive network analysis via fieldbus. Metrics, such as effective and apparent power consumption or load condition, enable the operator to optimize supply to a drive or machine. This can protect the installation from damage and failure.

Data

Technical Data

Number of measurement inputs	6 (3 voltage measurement inputs, 3 current measurement inputs)
Type of signal	Power measurement

Subject to changes. Please also observe the further product documentation!



Signal form	any (in consideration of the maximum operating frequency)
Resolution [bit]	16 Bit
Bit width	2 x 48-bit data; 2 x 24-bit control/status (optional)
Input resistance voltage path (typ.)	1071 kΩ
Input resistance current path typ.	22 mΩ
Bezug für Messfehler	AC current/voltage
Messfehler, Bezugstemperatur	25 °C
Messfehler, Abweichung max. vom Messbereichsendwert	0.5 %
Measuring current (max.)	1 A
Measuring voltage (max.)	500 VAC, 3 phases
Measuring cycle time	Adjustable measuring cycle time for Min_Max_Values
Frequency range with activated DC filter	10 ... 2000 Hz
Frequency range with deactivated DC filter	0 ... 2000 Hz
Frequency range, power supply frequency	45 ... 65 Hz
Operating frequency	7.2 kHz
Rated voltage	$U_{LN} = 277 \text{ V AC/DC}; U_{LL} = 480 \text{ VAC}$
Measured values	Active power, active energy, grid frequency, $\cos \varphi$
Messkomponenten	Evaluating
Measuring procedure	True RMS measurement
System supply voltage	DC 5 V; via data contacts
Current consumption, system supply (5 V)	100 mA
Isolation	4 kV system/field
Rated surge voltage	4 kV

Connection data

Connection technology: In-/Outputs	8 x CAGE CLAMP®
Connection type (1)	Inputs/Outputs
Solid conductor	0,08 ... 2,5 mm ² / 28 ... 14 AWG
Fine-stranded conductor	0,08 ... 2,5 mm ² / 28 ... 14 AWG
Strip length	8 ... 9 mm / 0.31 ... 0.35 inch

Geometrical Data

Width	12 mm / 0.472 inch
Height	67,8 mm / 2.669 inch
Height from upper-edge of DIN-35 rail	60,6 mm / 2.386 inch
Depth	100 mm / 3.937 inch

Subject to changes. Please also observe the further product documentation!

WAGO Kontakttechnik GmbH & Co. KG
Hansastr. 27
32423 Minden
Phone: +49571 887-0 | Fax: +49571 887-169
Email: info.de@wago.com | Web: www.wago.com

Do you have any questions about our products?
We are always happy to take your call at +49 (571) 887-44222.



Mechanical data

Type of mounting	DIN-35 rail
------------------	-------------

Material Data

Color	light gray
Housing material	Polycarbonate, polyamide 6.6
Weight	48.5 g
Conformity marking	CE

Environmental Requirements

Surrounding air (operating) temperature	0 ... 55 °C
Surrounding air (storage) temperature	-40 ... 85 °C
Protection class	IP20
Degree of pollution (5)	2 per IEC 61131-2
Operating altitude	0 ... 2000 m
Mounting position	horizontal (standing/lying); vertical
Relative air humidity (no condensation)	95 %
Vibration resistance	per IEC 60068-2-6
Shock resistance	15g per IEC 60068-2-27
EMC immunity to interference	per EN 61000-6-2
EMC emission of interference	per EN 61000-6-3
Exposure to pollutants	Per IEC 60068-2-42 and IEC 60068-2-43
Permissible H ₂ S contaminant concentration at a relative humidity 75 %	10 ppm
Permissible SO ₂ contaminant concentration at a relative humidity 75 %	25 ppm

Commercial data

Packaging type	BOX
Country of origin	DE
GTIN	4055143374385
Customs Tariff No.	85389099990

Approvals / Certificates



Ex-Approvals

Certificate

Subject to changes. Please also observe the further product documentation!

WAGO Kontakttechnik GmbH & Co. KG
 Hansastr. 27
 32423 Minden
 Phone: +49571 887-0 | Fax: +49571 887-169
 Email: info.de@wago.com | Web: www.wago.com

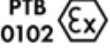
Do you have any questions about our products?
 We are always happy to take your call at +49 (571) 887-44222.

Logo	Approval	Additional Approval Text	name
	ATEX TUEV Nord Cert GmbH	EN 60079-0	TÜV 07 ATEX 554086 X en.
	TUEV Nord TUEV Nord Cert GmbH	IEC 60079-0	IECEX TUN 09.0001 X
	UL Underwriters Laboratories Inc. (HAZARDOUS LOCATIONS)	UL 121201	E198726 Sec.1

Country specific Approvals

Logo	Approval	Additional Approval Text	Certificate name
	KC National Radio Research Agency	Article 58-2, Clause 3	MSIP- REM-W43- AIM750

UL-Approvals

Logo	Approval	Additional Approval Text	Certificate name
	UL UL International Netherlands B.V. (ORDINARY LOCATIONS)	UL 508	E175199 Sec.1

Counterpart

Compatible products













current transformer

Item no.: 855-1001/2500-1001













Subject to changes. Please also observe the further product documentation!

WAGO Kontakttechnik GmbH & Co. KG
 Hansastr. 27
 32423 Minden
 Phone: +49571 887-0 | Fax: +49571 887-169
 Email: info.de@wago.com | Web: www.wago.com

Do you have any questions about our products?
 We are always happy to take your call at +49 (571) 887-44222.

	Plug-in current transformer; Primary rated current: 2500 A; Secondary rated current: 1 A; Rated power: 10 VA; Accuracy class: 1	www.wago.com/855-1001/2500-1001
	Item no.: 855-1700/032-000 Plug-in current transformer; Primary rated current 32 A; Secondary rated current 320 mA	www.wago.com/855-1700/032-000
	Item no.: 855-2701/035-001 Plug-in current transformer; Primary rated current: 35 A; Secondary rated current: 1 A; Rated power: 0.2 VA; Accuracy class: 1	www.wago.com/855-2701/035-001
	Item no.: 855-2701/064-001 Plug-in current transformer; Primary rated current: 64 A; Secondary rated current: 1 A; Rated power: 0.2 VA; Accuracy class: 1	www.wago.com/855-2701/064-001
	Item no.: 855-3001/060-003 Split-core current transformer; Primary rated current: 60 A; Secondary rated current: 1 A; Rated power: 0.2 VA; Accuracy class: 3; Cable length: 3 m	www.wago.com/855-3001/060-003
	Item no.: 855-3001/100-003 Split-core current transformer; Primary rated current: 100 A; Secondary rated current: 1 A; Rated power: 0.2 VA; Accuracy class: 3; Cable length: 3 m	www.wago.com/855-3001/100-003
	Item no.: 855-3001/200-001 Split-core current transformer; Primary rated current: 200 A; Secondary rated current: 1 A; Rated power: 0.2 VA; Accuracy class: 1; Cable length: 3 m	www.wago.com/855-3001/200-001
	Item no.: 855-3001/250-001 Split-core current transformer; Primary rated current: 250 A; Secondary rated current: 1 A; Rated power: 0.2 VA; Accuracy class: 1; Cable length: 3 m	www.wago.com/855-3001/250-001
	Item no.: 855-301/050-103 Plug-in current transformer; Primary rated current: 50 A; Secondary rated current: 1 A; Rated power: 1.25 VA; Accuracy class: 3	www.wago.com/855-301/050-103
	Item no.: 855-301/060-101 Plug-in current transformer; Primary rated current: 60 A; Secondary rated current: 1 A; Rated power: 1.25 VA; Accuracy class: 1	www.wago.com/855-301/060-101
	Item no.: 855-301/075-201 Plug-in current transformer; Primary rated current: 75 A; Secondary rated current: 1 A; Rated power: 2.5 VA; Accuracy class: 1	www.wago.com/855-301/075-201
	Item no.: 855-301/100-201 Plug-in current transformer; Primary rated current: 100 A; Secondary rated current: 1 A; Rated power: 2.5 VA; Accuracy class: 1	www.wago.com/855-301/100-201
	Item no.: 855-301/150-501 Plug-in current transformer; Primary rated current: 150 A; Secondary rated current: 1 A; Rated power: 5 VA; Accuracy class: 1	www.wago.com/855-301/150-501
	Item no.: 855-301/200-501	

Subject to changes. Please also observe the further product documentation!

















	Plug-in current transformer; Primary rated current: 200 A; Secondary rated current: 1 A; Rated power: 5 VA; Accuracy class: 1	www.wago.com/855-301/200-501
	Item no.: 855-301/250-501 Plug-in current transformer; Primary rated current: 250 A; Secondary rated current: 1 A; Rated power: 5 VA; Accuracy class: 1	www.wago.com/855-301/250-501
	Item no.: 855-301/400-1001 Plug-in current transformer; Primary rated current: 400 A; Secondary rated current: 1 A; Rated power: 10 VA; Accuracy class: 1	www.wago.com/855-301/400-1001
	Item no.: 855-301/600-1001 Plug-in current transformer; Primary rated current: 600 A; Secondary rated current: 1 A; Rated power: 10 VA; Accuracy class: 1	www.wago.com/855-301/600-1001
	Item no.: 855-4001/100-001 Split-core current transformer; Primary rated current: 100 A; Secondary rated current: 1 A; Rated power: 0.2 VA; Accuracy class: 1; Cable length: 3 m	www.wago.com/855-4001/100-001
	Item no.: 855-4001/150-001 Split-core current transformer; Primary rated current: 150 A; Secondary rated current: 1 A; Rated power: 0.2 VA; Accuracy class: 1; Cable length: 3 m	www.wago.com/855-4001/150-001
	Item no.: 855-4001/200-001 Split-core current transformer; Primary rated current: 200 A; Secondary rated current: 1 A; Rated power: 0.2 VA; Accuracy class: 1; Cable length: 3 m	www.wago.com/855-4001/200-001
	Item no.: 855-401/250-501 Plug-in current transformer; Primary rated current: 250 A; Secondary rated current: 1 A; Rated power: 5 VA; Accuracy class: 1	www.wago.com/855-401/250-501
	Item no.: 855-401/400-501 Plug-in current transformer; Primary rated current: 400 A; Secondary rated current: 1 A; Rated power: 5 VA; Accuracy class: 1	www.wago.com/855-401/400-501
	Item no.: 855-401/600-501 Plug-in current transformer; Primary rated current: 600 A; Secondary rated current: 1 A; Rated power: 10 VA; Accuracy class: 1	www.wago.com/855-401/600-501
	Item no.: 855-4101/200-001 Split-core current transformer; Primary rated current: 200 A; Secondary rated current: 1 A; Rated power: 0.2 VA; Accuracy class: 1; Cable length: 3 m	www.wago.com/855-4101/200-001
	Item no.: 855-4101/250-001 Split-core current transformer; Primary rated current: 250 A; Secondary rated current: 1 A; Rated power: 0.2 VA; Accuracy class: 1; Cable length: 3 m	www.wago.com/855-4101/250-001
	Item no.: 855-4101/400-001 Split-core current transformer; Primary rated current: 400 A; Secondary rated current: 1 A; Rated power: 0.2 VA; Accuracy class: 1; Cable length: 3 m	www.wago.com/855-4101/400-001

Item no.: 855-5001/1000-000

Subject to changes. Please also observe the further product documentation!

	Split-core current transformer; Primary rated current: 1000 A; Secondary rated current: 1 A; Rated power: 0.5 VA; Accuracy class: 0.5; Cable length: 5 m	www.wago.com/855-5001/1000-000
	Item no.: 855-5001/250-001 Split-core current transformer; Primary rated current: 250 A; Secondary rated current: 1 A; Rated power: 0.5 VA; Accuracy class: 1; Cable length: 5 m	www.wago.com/855-5001/250-001
	Item no.: 855-5001/400-000 Split-core current transformer; Primary rated current: 400 A; Secondary rated current: 1 A; Rated power: 0.5 VA; Accuracy class: 0.5; Cable length: 5 m	www.wago.com/855-5001/400-000
	Item no.: 855-5001/600-000 Split-core current transformer; Primary rated current: 600 A; Secondary rated current: 1 A; Rated power: 0.5 VA; Accuracy class: 0.5; Cable length: 5 m	www.wago.com/855-5001/600-000
	Item no.: 855-501/1000-1001 Plug-in current transformer; Primary rated current: 1000 A; Secondary rated current: 1 A; Rated power: 10 VA; Accuracy class: 1	www.wago.com/855-501/1000-1001
	Item no.: 855-501/400-1001 Plug-in current transformer; Primary rated current: 400 A; Secondary rated current: 1 A; Rated power: 10 VA; Accuracy class: 1	www.wago.com/855-501/400-1001
	Item no.: 855-501/600-1001 Plug-in current transformer; Primary rated current: 600 A; Secondary rated current: 1 A; Rated power: 10 VA; Accuracy class: 1	www.wago.com/855-501/600-1001
	Item no.: 855-501/800-1001 Plug-in current transformer; Primary rated current: 800 A; Secondary rated current: 1 A; Rated power: 10 VA; Accuracy class: 1	www.wago.com/855-501/800-1001
	Item no.: 855-5101/1000-000 Split-core current transformer; Primary rated current: 1000 A; Secondary rated current: 1 A; Rated power: 0.5 VA; Accuracy class: 0.5; Cable length: 5 m	www.wago.com/855-5101/1000-000
	Item no.: 855-601/1500-501 Plug-in current transformer; Primary rated current: 1500 A; Secondary rated current: 1 A; Rated power: 5 VA; Accuracy class: 1	www.wago.com/855-601/1500-501
	Item no.: 855-801/1000-1001 Plug-in current transformer; Primary rated current: 1000 A; Secondary rated current: 1 A; Rated power: 10 VA; Accuracy class: 1	www.wago.com/855-801/1000-1001
	Item no.: 855-801/2000-1001 Plug-in current transformer; Primary rated current: 2000 A; Secondary rated current: 1 A; Rated power: 10 VA; Accuracy class: 1	www.wago.com/855-801/2000-1001
Carrier rail		
	Item no.: 210-112 Steel carrier rail; 35 x 7.5 mm; 1 mm thick; 2 m long; slotted; according to EN 60715; "Hole width 25 mm	www.wago.com/210-112

Subject to changes. Please also observe the further product documentation!

	Item no.: 210-113 Steel carrier rail; 35 x 7.5 mm; 1 mm thick; 2 m long; unslotted; according to EN 60715	www.wago.com/210-113
	Item no.: 210-114 Steel carrier rail; 35 x 15 mm; 1.5 mm thick; 2 m long; unslotted; similar to EN 60715	www.wago.com/210-114
	Item no.: 210-115 Steel carrier rail; 35 x 7.5 mm; 1 mm thick; 2 m long; slotted; according to EN 60715; "Hole width 18 mm	www.wago.com/210-115
	Item no.: 210-118 Steel carrier rail; 35 x 15 mm; 2.3 mm thick; 2 m long; unslotted; according to EN 60715	www.wago.com/210-118
	Item no.: 210-196 Aluminum carrier rail; 35 x 8.2 mm; 1.6 mm thick; 2 m long; unslotted; similar to EN 60715; silver-colored	www.wago.com/210-196
	Item no.: 210-197 Steel carrier rail; 35 x 15 mm; 1.5 mm thick; 2 m long; slotted; similar to EN 60715	www.wago.com/210-197
	Item no.: 210-198 Copper carrier rail; 35 x 15 mm; 2.3 mm thick; 2 m long; unslotted; according to EN 60715; copper-colored	www.wago.com/210-198
	Item no.: 210-504 Steel carrier rail; 35 x 7.5 mm; 1 mm thick; 2 m long; slotted; galvanized; according to EN 60715	www.wago.com/210-504
	Item no.: 210-505 Steel carrier rail; 35 x 7.5 mm; 1 mm thick; 2 m long; unslotted; galvanized; according to EN 60715	www.wago.com/210-505
	Item no.: 210-506 Steel carrier rail; 35 x 15 mm; 1.5 mm thick; 2 m long; unslotted; galvanized; similar to EN 60715	www.wago.com/210-506
	Item no.: 210-508 Steel carrier rail; 35 x 15 mm; 1.5 mm thick; 2 m long; slotted; galvanized; similar to EN 60715	www.wago.com/210-508
General accessories		
	Item no.: 2007-8873 Compact terminal block; for current and voltage transformers; 6,00 mm ² ; multicoloured	www.wago.com/2007-8873
	Item no.: 2007-8875 Compact terminal block; for current transformer circuit; 6,00 mm ² ; multicoloured	www.wago.com/2007-8875
	Item no.: 855-8001 Power tap; with fuse; 2,5 mm ² (12 AWG) - 6 mm ² (10 AWG); Phase	www.wago.com/855-8001
	Item no.: 855-8002 Power tap; without fuse; 2,5 mm ² (12 AWG) - 6 mm ² (10 AWG); N-conductor	www.wago.com/855-8002
	Item no.: 855-8003 Power tap; with fuse; 10 mm ² (8 AWG) - 16 mm ² (6 AWG); Phase	www.wago.com/855-8003
	Item no.: 855-8004 Power tap; without fuse; 10 mm ² (8 AWG) - 16 mm ² (6 AWG); N-conductor	www.wago.com/855-8004

Item no.: 855-951/250-000







Subject to changes. Please also observe the further product documentation!









Current and voltage tap up to 95 mm²; Primary rated current: 250 A; Secondary rated current: 1 A;
Rated power: 0.2 VA; Accuracy class: 0.5; fused

www.wago.com/855-951/250-000















shield connection

	Item no.: 790-108 Shield clamping saddle; 11 mm wide; diameter of compatible conductor; 3 ... 8 mm	www.wago.com/790-108
	Item no.: 790-116 Shield clamping saddle; 19 mm wide; diameter of compatible conductor; 7 ... 16 mm	www.wago.com/790-116
	Item no.: 790-124 Shield clamping saddle; 27 mm wide; diameter of compatible conductor; 6 ... 24 mm	www.wago.com/790-124
	Item no.: 790-140 Shield clamping saddle; diameter of compatible conductor	www.wago.com/790-140
	Item no.: 790-208 Shield clamping saddle; 12.4 mm wide; 3 ... 8 mm	www.wago.com/790-208
	Item no.: 790-216 Shield clamping saddle; 21.8 mm wide; 6 ... 16 mm	www.wago.com/790-216
	Item no.: 790-220 Shield clamping saddle; 30 mm wide; 6 ... 20 mm	www.wago.com/790-220















Marking accessories

	Item no.: 2009-145 Mini-WSB Inline; for Smart Printer; 1700 pieces on roll; stretchable 5 - 5.2 mm; plain; snap-on type; white	www.wago.com/2009-145
	Item no.: 2009-145/000-002 Mini-WSB Inline; for Smart Printer; 1700 pieces on roll; stretchable 5 - 5.2 mm; plain; snap-on type; white /000-002	www.wago.com/2009-145/000-002
	Item no.: 2009-145/000-005 Mini-WSB Inline; for Smart Printer; 1700 pieces on roll; stretchable 5 - 5.2 mm; plain; snap-on type; red /000-005	www.wago.com/2009-145/000-005
	Item no.: 2009-145/000-006 Mini-WSB Inline; for Smart Printer; 1700 pieces on roll; stretchable 5 - 5.2 mm; plain; snap-on type; blue /000-006	www.wago.com/2009-145/000-006
	Item no.: 2009-145/000-007 Mini-WSB Inline; for Smart Printer; 1700 pieces on roll; stretchable 5 - 5.2 mm; plain; snap-on type; white /000-007	www.wago.com/2009-145/000-007
	Item no.: 2009-145/000-012 Mini-WSB Inline; for Smart Printer; 1700 pieces on roll; stretchable 5 - 5.2 mm; plain; snap-on type; orange	www.wago.com/2009-145/000-012
	Item no.: 2009-145/000-023 Mini-WSB Inline; for Smart Printer; 1700 pieces on roll; stretchable 5 - 5.2 mm; plain; snap-on type; green	www.wago.com/2009-145/000-023

Subject to changes. Please also observe the further product documentation!

	Item no.: 2009-145/000-024 Mini-WSB Inline; for Smart Printer; 1700 pieces on roll; stretchable 5 - 5.2 mm; plain; snap-on type; violet	www.wago.com/2009-145/000-024
	Item no.: 248-501 Miniature WSB Quick marking system; plain; Marker width 5 mm; 10 strips with 10 markers per card	www.wago.com/248-501
	Item no.: 248-501/000-002 Mini-WSB marking card; as card; not stretchable; plain; snap-on type; yellow	www.wago.com/248-501/000-002
	Item no.: 248-501/000-005 Mini-WSB marking card; as card; not stretchable; plain; snap-on type; red	www.wago.com/248-501/000-005
	Item no.: 248-501/000-006 Mini-WSB marking card; as card; not stretchable; plain; snap-on type; blue	www.wago.com/248-501/000-006
	Item no.: 248-501/000-007 Mini-WSB marking card; as card; not stretchable; plain; snap-on type; gray	www.wago.com/248-501/000-007
	Item no.: 248-501/000-012 Mini-WSB marking card; as card; not stretchable; plain; snap-on type; orange	www.wago.com/248-501/000-012
	Item no.: 248-501/000-017 Mini-WSB marking card; as card; not stretchable; plain; snap-on type; light green	www.wago.com/248-501/000-017
	Item no.: 248-501/000-023 Mini-WSB marking card; as card; not stretchable; plain; snap-on type; green	www.wago.com/248-501/000-023
	Item no.: 248-501/000-024 Mini-WSB marking card; as card; not stretchable; plain; snap-on type; violet	www.wago.com/248-501/000-024
	Item no.: 750-103 Group marker carrier; transparent	www.wago.com/750-103
	Item no.: 750-107 Group marker carrier; transparent	www.wago.com/750-107
system box		
	Item no.: 850-804 IP65 enclosure; Stainless steel; WxHxD (400x123x200 mm); 4 x M20, 16 x M16, 28 x M12 cable grip	www.wago.com/850-804
	Item no.: 850-804/000-001 IP65 enclosure; Stainless steel; WxHxD (400x123x200 mm); 2 x M20, 13 x M16, 32 x M12 cable grip	www.wago.com/850-804/000-001

Subject to changes. Please also observe the further product documentation!

	Item no.: 850-805 IP65 enclosure; Stainless steel; WxHxD (600x123x200 mm); 4 x M20, 19 x M16, 67 x M12 cable grip	www.wago.com/850-805
	Item no.: 850-814/002-000 IP65 enclosure; Sheet steel (RAL 7035); WxHxD (200x120x200 mm); without flange plate	www.wago.com/850-814/002-000
	Item no.: 850-815/002-000 IP65 enclosure; Sheet steel (RAL 7035); WxHxD (300x120x200 mm); without flange plate	www.wago.com/850-815/002-000
	Item no.: 850-816/002-000 IP65 enclosure; Sheet steel (RAL 7035); WxHxD (400x120x200 mm); without flange plate	www.wago.com/850-816/002-000
	Item no.: 850-817/002-000 IP65 enclosure; Sheet steel (RAL 7035); WxHxD (600x120x200 mm); without flange plate	www.wago.com/850-817/002-000
	Item no.: 850-825 IP65 enclosure; Aluminium (RAL 7032); WxHxD (160x100x160 mm); 9 x M12, 4 x M20	www.wago.com/850-825
	Item no.: 850-826 IP65 enclosure; Aluminium (RAL 7032); WxHxD (240x100x160 mm); 4 x M20, 4 x M16, 14 x M12 cable grip	www.wago.com/850-826
	Item no.: 850-826/002-000 IP65 enclosure; Aluminium (RAL 7035); WxHxD (240x100x160 mm); 4 x M20, 4 x M16, 14 x M12 cable grip	www.wago.com/850-826/002-000
	Item no.: 850-827 IP65 enclosure; Aluminium (RAL 7032); WxHxD (320x100x160 mm); 4 x M20, 8 x M16, 17 x M12 cable grip	www.wago.com/850-827
	Item no.: 850-827/002-000 IP65 enclosure; Aluminium (RAL 7035); WxHxD (320x100x160 mm); 4 x M20, 8 x M16, 17 x M12 cable grip	www.wago.com/850-827/002-000
	Item no.: 850-828 IP65 enclosure; Aluminium (RAL 7032); WxHxD (480x100x160 mm); 4 x M20, 10 x M16, 35 x M12 cable grip	www.wago.com/850-828
	Item no.: 850-828/002-000 IP65 enclosure; Aluminium (RAL 7035); WxHxD (480x100x160 mm); 4 x M20, 10 x M16, 35 x M12 cable grip	www.wago.com/850-828/002-000
	Item no.: 850-834 IP65 enclosure; Polyester (RAL 7032); WxHxD (164x100x164 mm); 9 x M12, 4 x M20	www.wago.com/850-834
	Item no.: 850-835 IP65 enclosure; Polyester (RAL 7032); WxHxD (244x100x164 mm); 4 x M20, 4 x M16, 14 x M12 cable grip	www.wago.com/850-835
	Item no.: 850-836 IP65 enclosure; Polyester (RAL 7032); WxHxD (324x100x164 mm); 4 x M20, 8 x M16, 17 x M12 cable grip	www.wago.com/850-836

Subject to changes. Please also observe the further product documentation!



Downloads

Documentation

Manual

3-Phase Power Measurement Module	V 1.2.0	pdf 3.9 MB	Download
----------------------------------	---------	---------------	----------

Bid Text

750-493 X81 - Datei	Feb 19, 2019	xml 6.0 kB	Download
------------------------	--------------	---------------	----------

750-493 docx - Datei	Jun 26, 2019	docx 18.4 kB	Download
-------------------------	--------------	-----------------	----------

Additional Information

Disposal; Electrical and electronic equipment, Packaging	V 1.0.0	pdf 265.8 kB	Download
--	---------	-----------------	----------

System Description

Use in Hazardous Environments Term definition, marking and installation regulations	V 1.0.0	pdf 1.0 MB	Download
--	---------	---------------	----------

750/753 Series I/O-System – General Product Information		pdf 1.7 MB	Download
---	--	---------------	----------

Overview on WAGO-I/O-SYSTEM 750 approvals		pdf 780.2 kB	Download
---	--	-----------------	----------

Design Notes Basic conditions and recommendations for higher operational safety	V 2.0.0	pdf 1.5 MB	Download
--	---------	---------------	----------

Application Notes

Application Note CoDeSys 2.3

Application Note PowerMeasurement_03 Library	19.01.2011	zip	Download
This application note describes how current, voltage, effective power, power factor and energy consumption can be measured using 3-phase power measurement modules (750-493).	Mar 19, 2012	954.5 kB	

Subject to changes. Please also observe the further product documentation!



Libraries

Library

Libraries for Building Automation CODESYS 2.3	2020-02-14 Feb 14, 2020	zip 78.5 MB	Download
<p>This zip file contains WAGO I / O PRO libraries for building automation. Blocks are available for the following applications: - DALI - DALI sensors - DALI Color Control - DALI Emergency Lighting - Enocean - SMI - HVAC / HVAC functions - General building functions such as blinds, dimmers, impulse switches - Scheduler - KNX function blocks - BACnet - WINSTA blind box - DMX - Elsner weather station - M-Bus, MBus - MP-Bus, MPBus - Romutec handset - Thermokon Thanos room thermostat - Thermokon WRF04 room thermostat - Thermokon WRF06 room thermostat - Thermokon WRF07 room thermostat - Thermokon WRF08 room thermostat - 3-phase Power measuring module 750-493 - LON - Grundfos pumps with GENIbus interface - EAP Modbus® room control units - Conversion of color formats - "robutecheasy" modules - Schüco TipTronic group control units - Weather station Thies</p>			

CAD/CAE-Data

CAD data

2D/3D Models 750-493	URL	Download
----------------------	-----	----------

CAE data

EPLAN Data Portal 750-493	URL	Download
---------------------------	-----	----------

WSCAD Universe 750-493	URL	Download
------------------------	-----	----------

Device Files

Device Driver

WAGO USB Service Kabel Treiber / Serie 750 und 857	6.5.3.0 Sep 10, 2014	zip 4.8 MB	Download
--	-------------------------	---------------	----------

Installation Notes

Product family

750/753 Series – I/O System
[Show all products from the family](#)

Subject to changes. Please also observe the further product documentation!