

Peak Emission Wavelength: 1200 nm

The 1200nm IR emitter series is designed for applications requiring precise optical / mechanical axis alignment and IR radiation in the SWIR range. Custom package solutions and sorting are available.

FEATURES

- > 3mm Plastic Package
- > Wide Beam Angle
- > High Reliability

APPLICATIONS

- > Bio Medical Applications
- > Optical Sensors
- > Optical Communications



Absolute Maximum Ratings (Ta=25°C)



ITEMS	SYMBOL	RATINGS	UNIT
Forward Current (DC)	IF	100	mA
Forward Current (Pulse)*1	IFP	1	A
Reverse Voltage	VR	5	V
Power Dissipation	PD	100	mW
Operating Temperature Range	Topr	-25 ~ +85	°C
Storage Temperature Range	Tstg	-30 ~ +100	°C
Lead Soldering Temperature*2	Tls	260	°C

*1: Tw=10μsec, T=10msec; *2: Time 5 Sec max, Position: Up to 3mm from the body.

Electrical & Optical Characteristics (Ta = 25°C)

ITEMS	SYMBOL	CONDITIONS	MIN	TYP	MAX	UNIT
Power Output	PO	IF=50mA	--	13.8	--	mW
Forward Voltage	VF	IF=50mA	--	1.08	--	V
Power Output	PO	IF=20mA	--	6.3	--	mW
Forward Voltage	VF	IF=20mA	--	0.98	--	V
Reverse Current	IR	VR=5V	--	--	--	μA
Peak Emission Wavelength	λp	IF=20mA	--	1200	--	nm
Spectral Line Half Width	Δλ	IF=20mA	--	65	--	nm
Half Intensity Beam Angle	Θ	IF=20mA	--	120	--	deg

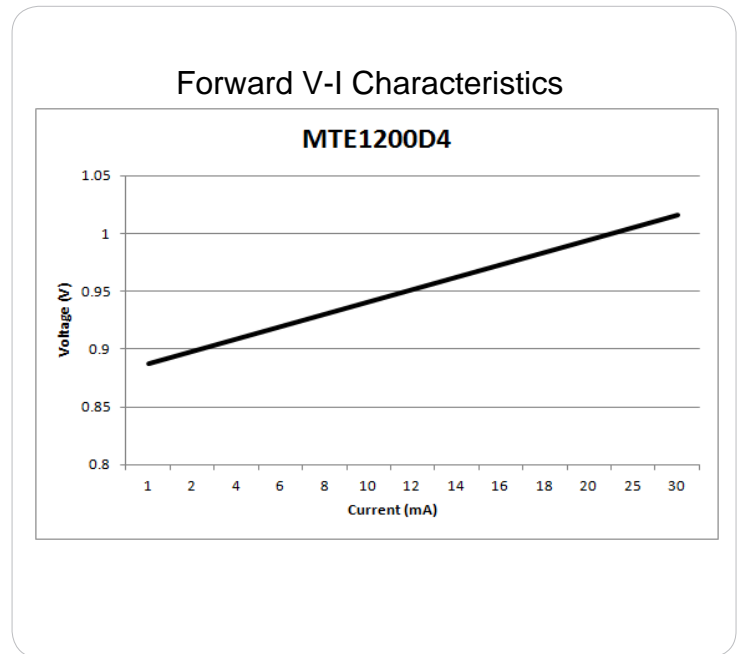
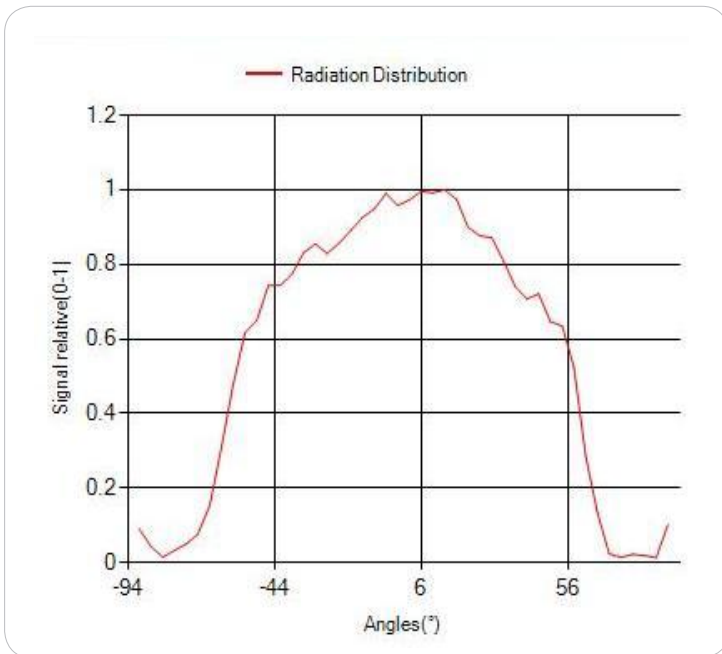
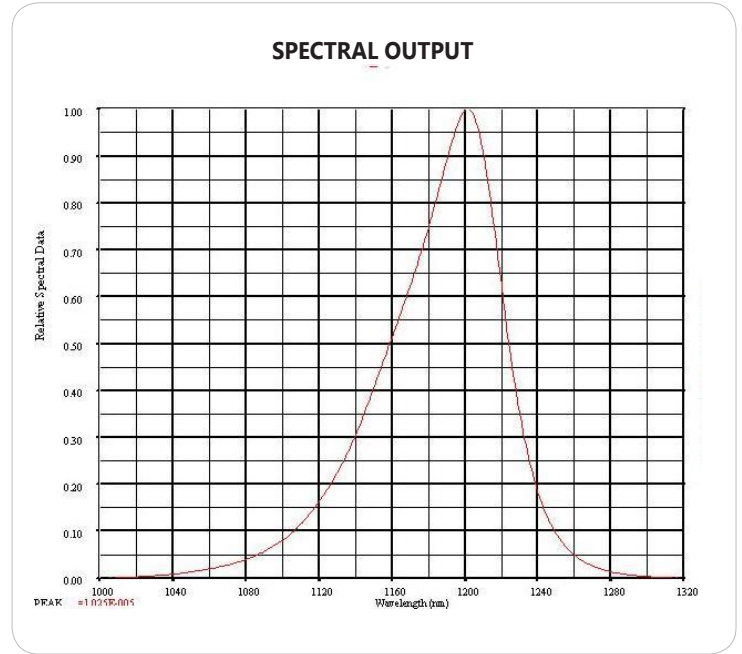
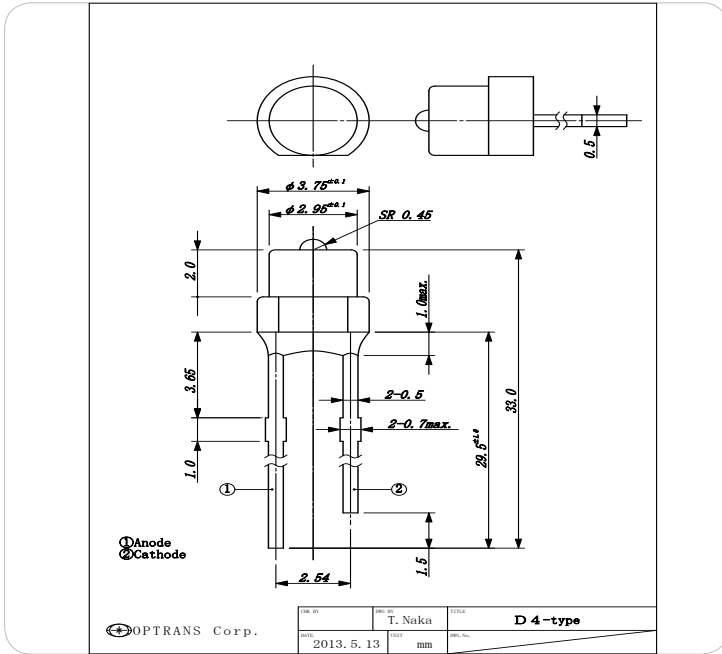

Unit: mm, Tolerance: ±0.2

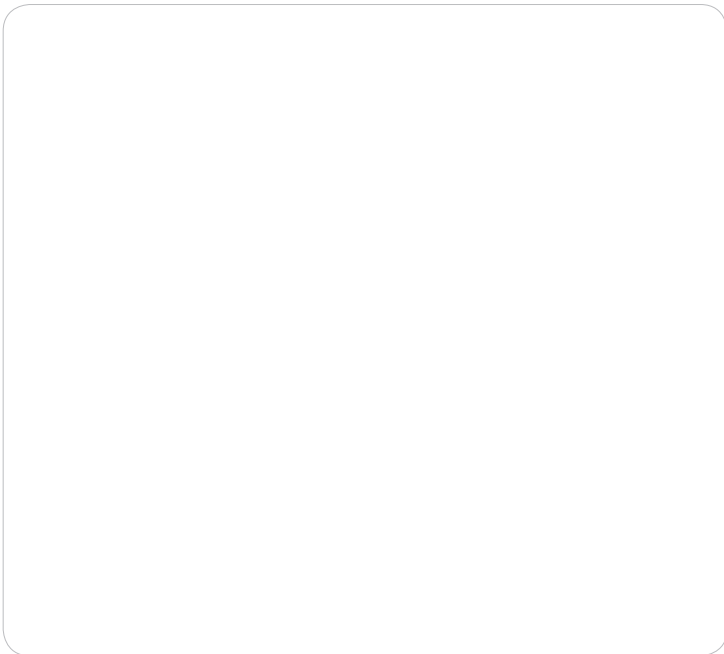
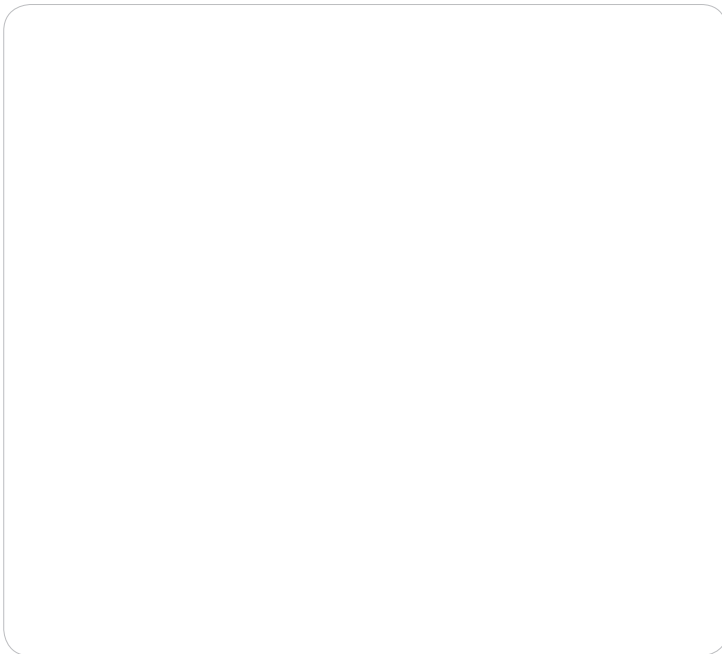
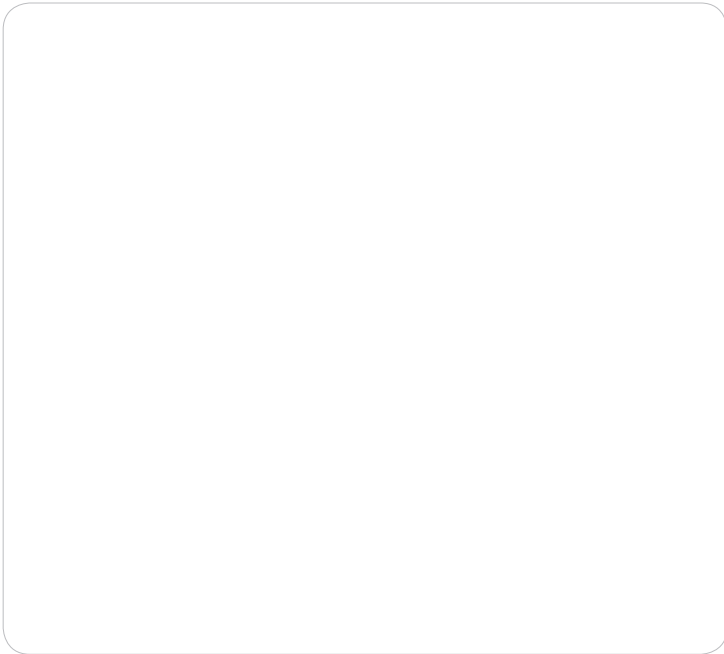
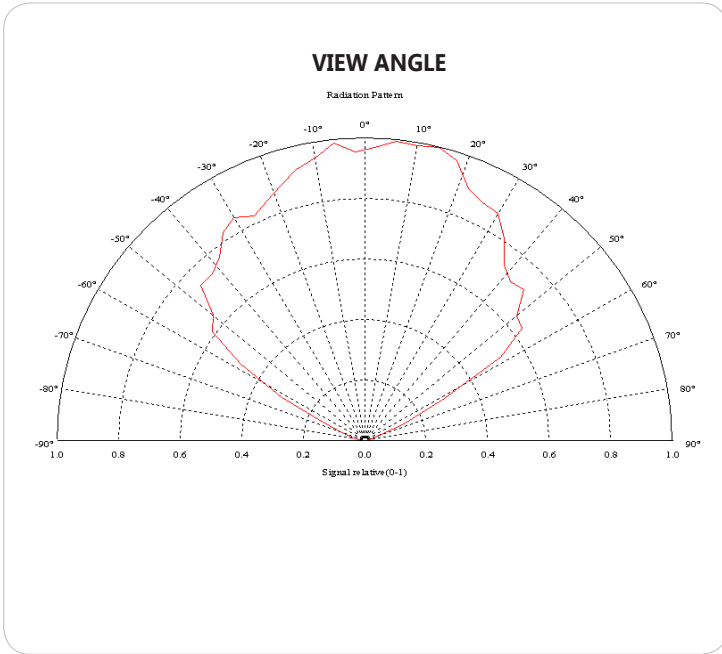

The information contained herein is subject to change without notice.

2019-01-15

Mouser Electronics

Authorized Distributor

Click to View Pricing, Inventory, Delivery & Lifecycle Information:

[Marktech Optoelectronics:](#)

[MTE1200D4](#)